

3950X SERIES
3.50mm HEADERS

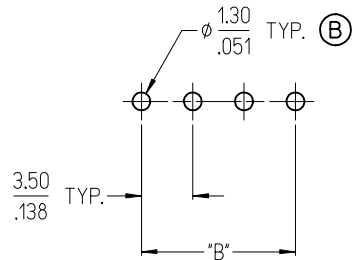

3952X & 3954X SERIES
5.00mm HEADERS
5.00mm FIXED

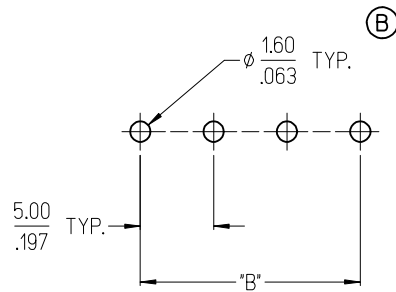

3953X SERIES
5.08mm HEADERS

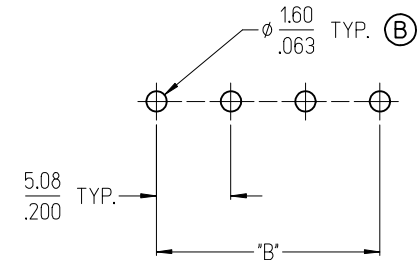

3951X SERIES
3.81mm HEADERS

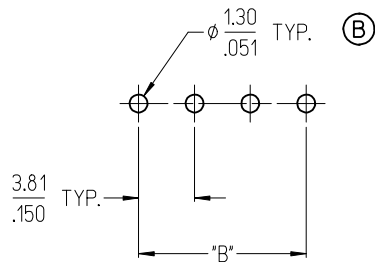

3954X SERIES
5.00mm FIXED

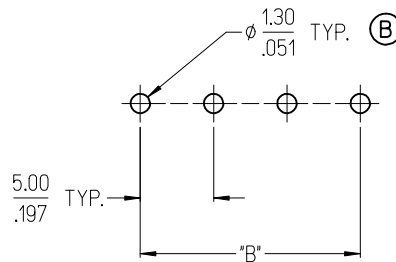

3954X SERIES
5.08mm FIXED

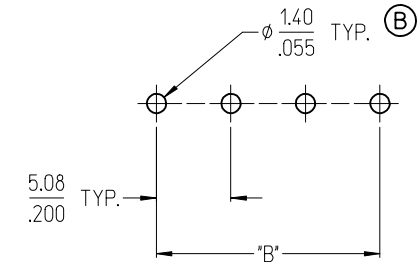

NOTES:

- REFER TO INDIVIDUAL PRODUCT SALES DRAWINGS FOR "B" DIMENSION.
- DOES NOT APPLY TO DUAL LEVEL HEADERS, SERIES 39528 AND 39538.
- TYP. = TYPICAL.

TOLERANCES			
MM	TOL	INCH	TOL
0-6	±0.25	0-.24	±.010
>6-30	±0.40	.24-1.18	±.016
>30-120	±0.50	1.18-4.76	±.020
>120	±0.80	>4.76	±.031

REVISED DOC TOL
EC NO: IPG2017-0881
DRAWN: VASUTHKARP 2017/03/23
CHKD:
APPR: BRUPERT 2017/04/18
REV DESCRIPTION

QUALITY SYMBOLS
▽=0
▽=0

GENERAL TOLERANCES (UNLESS SPECIFIED)

	mm	INCH
4 PLACES	±---	±---
3 PLACES	±---	±---
2 PLACES	±---	±---
1 PLACE	±---	±---
ANGULAR ±---°		

DRAFT WHERE APPLICABLE
MUST REMAIN
WITHIN DIMENSIONS

DIMENSION STYLE
MM/IN

DRAWN BY	DATE
C. YORK	2006/08/25
CHECKED BY	DATE
J. MACNEIL	2006/08/25
APPROVED BY	DATE
J. MACNEIL	2006/08/25

MATERIAL NO. --

SCALE DESIGN UNITS INCH

THIRD ANGLE PROJECTION

TITLE
RECOMMENDED PCB LAYOUT FOR ESE TERMINAL BLOCKS

molex MOLEX INCORPORATED

DOCUMENT NO. SD-39501-002

SHEET NO. 1 OF 1

THIS DRAWING CONTAINS INFORMATION THAT IS PROPRIETARY TO MOLEX INCORPORATED AND SHOULD NOT BE USED WITHOUT WRITTEN PERMISSION

3950X SERIES
3.50mm HEADERS

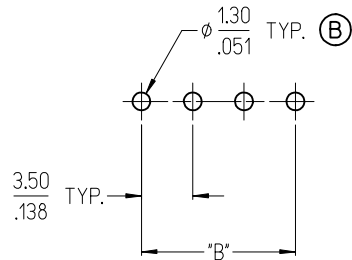

3952X & 3954X SERIES
5.00mm HEADERS
5.00mm FIXED

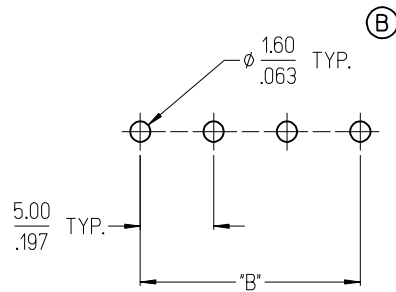

3953X SERIES
5.08mm HEADERS

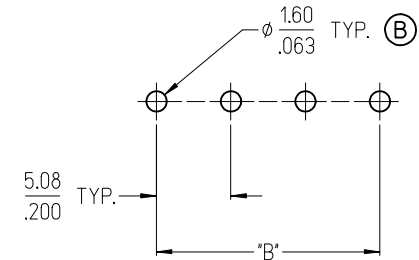

3951X SERIES
3.81mm HEADERS

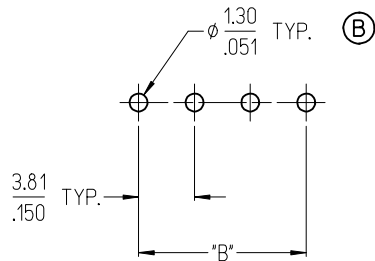

3954X SERIES
5.00mm FIXED

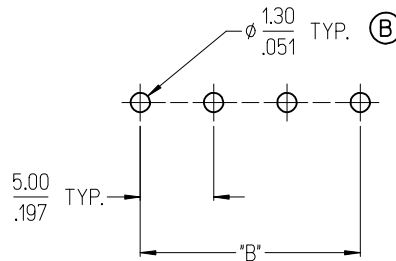

3954X SERIES
5.08mm FIXED

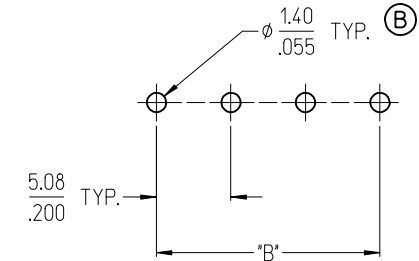

NOTES:

- REFER TO INDIVIDUAL PRODUCT SALES DRAWINGS FOR "B" DIMENSION.
- DOES NOT APPLY TO DUAL LEVEL HEADERS, SERIES 39528 AND 39538.
- TYP. = TYPICAL.

TOLERANCES			
MM	TOL	INCH	TOL
0-6	±0.25	0-.24	±.010
>6-30	±0.40	.24-1.18	±.016
>30-120	±0.50	1.18-4.76	±.020
>120	±0.80	>4.76	±.031

REVISED DOC TOL
EC NO: IPG2017-0881
DRAWN: VASUTHKARP 2017/03/23
CHKD:
APPR: BRUPERT 2017/04/18
REV DESCRIPTION

QUALITY SYMBOLS
▽=0
▽=0

GENERAL TOLERANCES (UNLESS SPECIFIED)

	mm	INCH
4 PLACES	±---	±---
3 PLACES	±---	±---
2 PLACES	±---	±---
1 PLACE	±---	±---
ANGULAR ±---°		

DRAFT WHERE APPLICABLE
MUST REMAIN
WITHIN DIMENSIONS

DIMENSION STYLE
MM/IN

DRAWN BY	DATE
C. YORK	2006/08/25
CHECKED BY	DATE
J. MACNEIL	2006/08/25
APPROVED BY	DATE
J. MACNEIL	2006/08/25

MATERIAL NO. --

SCALE DESIGN UNITS INCH

THIRD ANGLE PROJECTION

TITLE
RECOMMENDED PCB LAYOUT FOR ESE TERMINAL BLOCKS

molex MOLEX INCORPORATED

DOCUMENT NO. SD-39501-002

SHEET NO. 1 OF 1

THIS DRAWING CONTAINS INFORMATION THAT IS PROPRIETARY TO MOLEX INCORPORATED AND SHOULD NOT BE USED WITHOUT WRITTEN PERMISSION

F

E

D

C

B

A

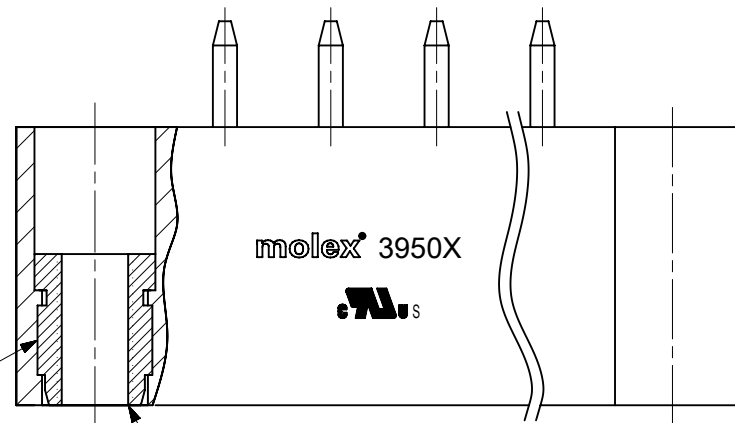

(C)
SEE NOTES 3 & 4

M2.5 THREAD

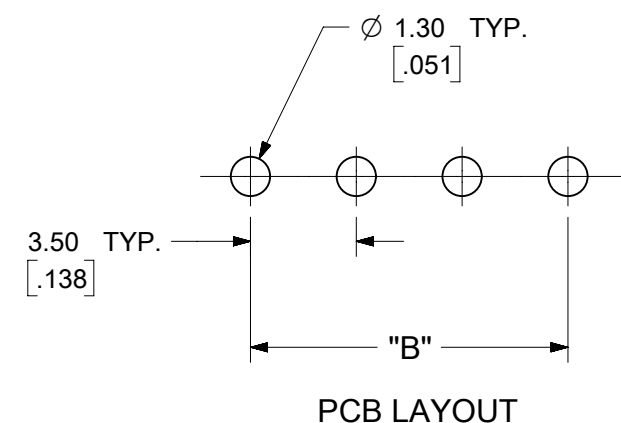
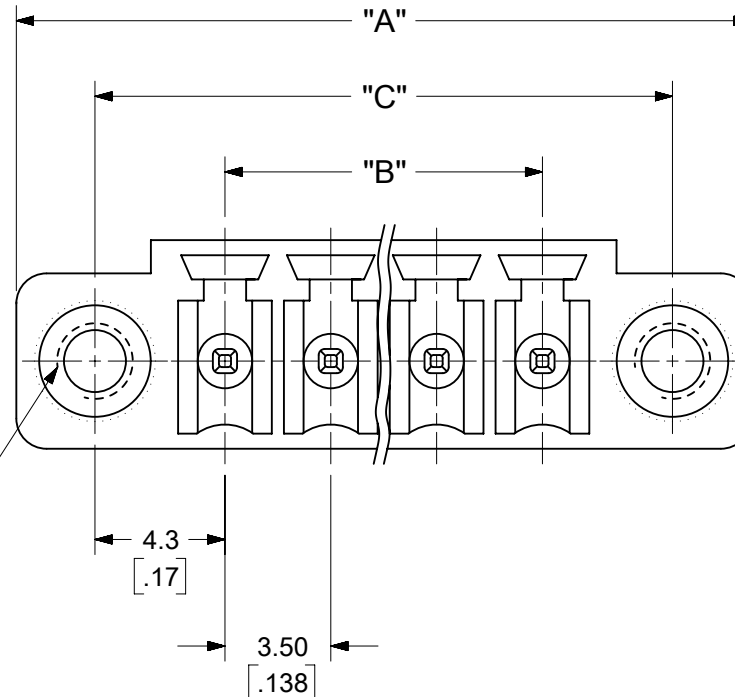
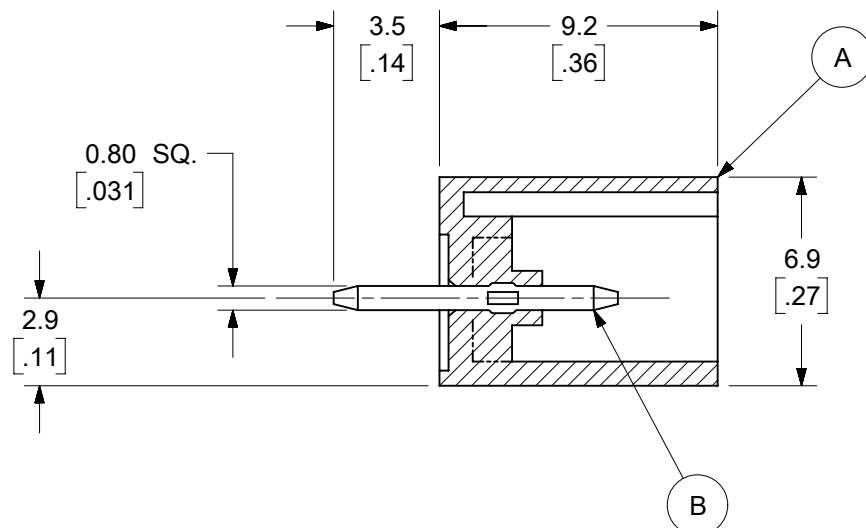

SPECIFICATIONS:

1. MATERIAL:
 - (A). BODY: PA66, UL 94V-0
 - (B). TERMINAL: BRASS - TIN PLATED
 - (C). THREADED INSERT: BRASS
2. ELECTRICAL RATING: 300V, 8A
3. MAX TORQUE: 1.59 in.lbs. (0.18NM)
4. MINIMUM INSERT RETENTION: 22 lbf (98N)
5. OPERATING TEMPERATURE: -40°C to +105°C
6. MAX. SOLDERING TEMP: 260°C (500°F) FOR 5 SECONDS
7. DIM A (OVERALL LENGTH)= (N x P) + 10.3mm
8. DIM B (CIRCUIT LENGTH)= (N - 1) x P
9. DIM C (MOUNTING HOLES)= (B + 8.6mm)
10. P (PITCH) = 3.50mm (.138")
11. N = NUMBER OF POSITIONS AVAILABLE 2 THROUGH 20
12. PRODUCT SPEC: PS-39500-001
13. SEE DRAWING SD-39501-002 FOR PTH INFO
14. DIMS. SHOWN ARE FOR REFERENCE ONLY.

TOLERANCES			
MM	TOL	INCH	TOL
0-6	±0.25	0-.24	±.010
>6-30	±0.40	.24-1.18	±.016
>30-120	±0.50	1.18-4.76	±.020
>120	±0.80	>4.76	±.031

THIS DRAWING CONTAINS INFORMATION THAT IS PROPRIETARY TO MOLEX ELECTRONIC TECHNOLOGIES, LLC AND SHOULD NOT BE USED WITHOUT WRITTEN PERMISSION									
SYMBOLS		DIMENSION UNITS		SCALE		CURRENT REV DESC: MIGRATION TO ECTR/NX			
= 0		MM/INCH		4:1					
= 0		GENERAL TOLERANCES (UNLESS SPECIFIED)							
= 0									
= 0		4 PLACES ±		±		EC NO: 619929			
= 0		3 PLACES ±		±		DRWN: ABENJAMINLW 2019/06/12			
= 0		2 PLACES ±		±		CHK'D: DACHAMMER 2019/07/01			
= 0		1 PLACE ±		±		APPR: JFMURPHY 2019/07/08			
= 0		0 PLACES ±		±		INITIAL REVISION:			
= 0		ANGULAR TOL ± °		°		DRWN: LROTHAUS 2006/01/09			
= 0		DRAFT WHERE APPLICABLE MUST REMAIN WITHIN DIMENSIONS		THIRD ANGLE PROJECTION		DRAWING		SERIES	
= 0				B-SIZE		39505		MATERIAL NUMBER	
								CUSTOMER	
								SHEET NUMBER	
								1 OF 2	

molex

3.5MM, EURO HEADER
VERTICAL, MOUNTING ENDS

PRODUCT CUSTOMER DRAWING

DOCUMENT NUMBER	DOC TYPE	DOC PART	REVISION
SD-39505-001	PSD	001	B2

DESCRIPTION	CIRCUIT SIZE	MATERIAL NUMBERS												DIMENSIONAL INFORMATION					
		BLACK						GREEN											
		100% TIN			30 u" GOLD			100% TIN			30 u" GOLD			DIM. "A"		DIM. "B"		DIM. "C"	
		PRINTING OPTIONS			PRINTING OPTIONS			PRINTING OPTIONS			PRINTING OPTIONS			mm	inch	mm	inch	mm	inch
		None	10AV	11AV	None	10AV	11AV	None	10AV	11AV	None	10AV	11AV						
3.5MM, EURO HEADER, VERTICAL, MOUNTING ENDS	2	395051002	395051302	395051402	395051502	395051802	395051902	395056002	395056302	395056402	395056502	395056802	395056902	17.30	.681	3.50	.138	12.10	.476
3.5MM, EURO HEADER, VERTICAL, MOUNTING ENDS	3	395051003	395051303	395051403	395051503	395051803	395051903	395056003	395056303	395056403	395056503	395056803	395056903	20.80	.819	7.00	.276	15.60	.614
3.5MM, EURO HEADER, VERTICAL, MOUNTING ENDS	4	395051004	395051304	395051404	395051504	395051804	395051904	395056004	395056304	395056404	395056504	395056804	395056904	24.30	.957	10.50	.413	19.10	.752
3.5MM, EURO HEADER, VERTICAL, MOUNTING ENDS	5	395051005	395051305	395051405	395051505	395051805	395051905	395056005	395056305	395056405	395056505	395056805	395056905	27.80	1.094	14.00	.551	22.60	.890
3.5MM, EURO HEADER, VERTICAL, MOUNTING ENDS	6	395051006	395051306	395051406	395051506	395051806	395051906	395056006	395056306	395056406	395056506	395056806	395056906	31.30	1.232	17.50	.689	26.10	1.028
3.5MM, EURO HEADER, VERTICAL, MOUNTING ENDS	7	395051007	395051307	395051407	395051507	395051807	395051907	395056007	395056307	395056407	395056507	395056807	395056907	34.80	1.370	21.00	.827	29.60	1.165
3.5MM, EURO HEADER, VERTICAL, MOUNTING ENDS	8	395051008	395051308	395051408	395051508	395051808	395051908	395056008	395056308	395056408	395056508	395056808	395056908	38.30	1.508	24.50	.965	33.10	1.303
3.5MM, EURO HEADER, VERTICAL, MOUNTING ENDS	9	395051009	395051309	395051409	395051509	395051809	395051909	395056009	395056309	395056409	395056509	395056809	395056909	41.80	1.646	28.00	1.102	36.60	1.441
3.5MM, EURO HEADER, VERTICAL, MOUNTING ENDS	10	395051010	395051310	395051410	395051510	395051810	395051910	395056010	395056310	395056410	395056510	395056810	395056910	45.30	1.783	31.50	1.240	40.10	1.579
3.5MM, EURO HEADER, VERTICAL, MOUNTING ENDS	11	395051011	395051311	395051411	395051511	395051811	395051911	395056011	395056311	395056411	395056511	395056811	395056911	48.80	1.921	35.00	1.378	43.60	1.717
3.5MM, EURO HEADER, VERTICAL, MOUNTING ENDS	12	395051012	395051312	395051412	395051512	395051812	395051912	395056012	395056312	395056412	395056512	395056812	395056912	52.30	2.059	38.50	1.516	47.10	1.854
3.5MM, EURO HEADER, VERTICAL, MOUNTING ENDS	13	395051013	395051313	395051413	395051513	395051813	395051913	395056013	395056313	395056413	395056513	395056813	395056913	55.80	2.197	42.00	1.654	50.60	1.992
3.5MM, EURO HEADER, VERTICAL, MOUNTING ENDS	14	395051014	395051314	395051414	395051514	395051814	395051914	395056014	395056314	395056414	395056514	395056814	395056914	59.30	2.335	45.50	1.791	54.10	2.130
3.5MM, EURO HEADER, VERTICAL, MOUNTING ENDS	15	395051015	395051315	395051415	395051515	395051815	395051915	395056015	395056315	395056415	395056515	395056815	395056915	62.80	2.472	49.00	1.929	57.60	2.268
3.5MM, EURO HEADER, VERTICAL, MOUNTING ENDS	16	395051016	395051316	395051416	395051516	395051816	395051916	395056016	395056316	395056416	395056516	395056816	395056916	66.30	2.610	52.50	2.067	61.10	2.406
3.5MM, EURO HEADER, VERTICAL, MOUNTING ENDS	17	395051017	395051317	395051417	395051517	395051817	395051917	395056017	395056317	395056417	395056517	395056817	395056917	69.80	2.748	56.00	2.205	64.60	2.543
3.5MM, EURO HEADER, VERTICAL, MOUNTING ENDS	18	395051018	395051318	395051418	395051518	395051818	395051918	395056018	395056318	395056418	395056518	395056818	395056918	73.30	2.886	59.50	2.343	68.10	2.681
3.5MM, EURO HEADER, VERTICAL, MOUNTING ENDS	19	395051019	395051319	395051419	395051519	395051819	395051919	395056019	395056319	395056419	395056519	395056819	395056919	76.80	3.024	63.00	2.480	71.60	2.819
3.5MM, EURO HEADER, VERTICAL, MOUNTING ENDS	20	395051020	395051320	395051420	395051520	395051820	395051920	395056020	395056320	395056420	395056520	395056820	395056920	80.30	3.161	66.50	2.618	75.10	2.957

TOLERANCES			
MM	TOL	INCH	TOL
0-6	±0.25	0-.24	±.010
>6-30	±0.40	.24-1.18	±.016
>30-120	±0.50	1.18-4.76	±.020
>120	±0.80	>4.76	±.031

SYMBOLS	THIS DRAWING CONTAINS INFORMATION THAT IS PROPRIETARY TO MOLEX ELECTRONIC TECHNOLOGIES, LLC AND SHOULD NOT BE USED WITHOUT WRITTEN PERMISSION		
	DIMENSION UNITS	SCALE	CURRENT REV DESC: MIGRATION TO ECTR/NX
▽ = 0	MM/INCH	2:1	EC NO: 619929 DRWN: ABENJAMINLW 2019/06/12 CHK'D: DACHAMMER 2019/07/01 APPR: JFMURPHY 2019/07/08
▽ = 0	GENERAL TOLERANCES (UNLESS SPECIFIED)		
▽ = 0	4 PLACES ±	±	INITIAL REVISION: DRWN: LROTHAUS 2006/01/09 APPR: JPAWLICK 2006/01/10
▽ = 0	3 PLACES ±	± SEE CHART	
▽ = 0	2 PLACES ±	± SEE CHART	DOCUMENT NUMBER SD-39505-001 DOC TYPE DOC PART REVISION PSD 001 B2
▽ = 0	1 PLACE ±	± SEE CHART	
▽ = 0	0 PLACES ±	±	MATERIAL NUMBER SEE TABLE CUSTOMER GENERAL MARKET SHEET NUMBER 2 OF 2
▽ = 0	ANGULAR TOL ± °	± °	
▽ = 0	DRAFT WHERE APPLICABLE MUST REMAIN WITHIN DIMENSIONS		THIRD ANGLE PROJECTION
▽ = 0	DRAWING	SERIES	
	B-SIZE	39505	

Description	Circuit size	Fractional Numbers											Dimensional Information							
		Black						Green					Dim. A		Dim B		Dim. C			
		100% Tin			30 UZ Gold			100% Tin			30 UZ Gold		mm		inch		mm		inch	
		Printing Options			Printing Options			Printing Options			Printing Options		mm	inch	mm	inch	mm	inch	mm	inch
3.5mm, Euro Header, Vertical, Mounting ends	2	395051002	395051302	395051402	395051502	395051802	395051902	395056002	395056302	395056402	395056502	395056802	395056902	17.30	0.681	3.50	0.138	12.10	0.478	
3.5mm, Euro Header, Vertical, Mounting ends	3	395051003	395051303	395051403	395051503	395051803	395051903	395056003	395056303	395056403	395056503	395056803	395056903	20.80	0.819	7.00	0.276	15.00	0.614	
3.5mm, Euro Header, Vertical, Mounting ends	4	395051004	395051304	395051404	395051504	395051804	395051904	395056004	395056304	395056404	395056504	395056804	395056904	24.30	0.957	10.50	0.413	19.10	0.752	
3.5mm, Euro Header, Vertical, Mounting ends	5	395051005	395051305	395051405	395051505	395051805	395051905	395056005	395056305	395056405	395056505	395056805	395056905	27.80	1.094	14.00	0.551	22.80	0.900	
3.5mm, Euro Header, Vertical, Mounting ends	6	395051006	395051306	395051406	395051506	395051806	395051906	395056006	395056306	395056406	395056506	395056806	395056906	31.30	1.232	17.50	0.689	26.10	1.028	
3.5mm, Euro Header, Vertical, Mounting ends	7	395051007	395051307	395051407	395051507	395051807	395051907	395056007	395056307	395056407	395056507	395056807	395056907	34.80	1.370	21.00	0.827	29.60	1.165	
3.5mm, Euro Header, Vertical, Mounting ends	8	395051008	395051308	395051408	395051508	395051808	395051908	395056008	395056308	395056408	395056508	395056808	395056908	38.30	1.508	24.50	0.965	33.10	1.303	
3.5mm, Euro Header, Vertical, Mounting ends	9	395051009	395051309	395051409	395051509	395051809	395051909	395056009	395056309	395056409	395056509	395056809	395056909	41.80	1.646	28.00	1.102	36.60	1.441	
3.5mm, Euro Header, Vertical, Mounting ends	10	395051010	395051310	395051410	395051510	395051810	395051910	395056010	395056310	395056410	395056510	395056810	395056910	45.30	1.783	31.50	1.240	40.10	1.579	
3.5mm, Euro Header, Vertical, Mounting ends	11	395051011	395051311	395051411	395051511	395051811	395051911	395056011	395056311	395056411	395056511	395056811	395056911	48.80	1.921	35.00	1.378	43.60	1.717	
3.5mm, Euro Header, Vertical, Mounting ends	12	395051012	395051312	395051412	395051512	395051812	395051912	395056012	395056312	395056412	395056512	395056812	395056912	52.30	2.059	38.50	1.516	47.10	1.854	
3.5mm, Euro Header, Vertical, Mounting ends	13	395051013	395051313	395051413	395051513	395051813	395051913	395056013	395056313	395056413	395056513	395056813	395056913	55.80	2.197	42.00	1.654	50.60	1.992	
3.5mm, Euro Header, Vertical, Mounting ends	14	395051014	395051314	395051414	395051514	395051814	395051914	395056014	395056314	395056414	395056514	395056814	395056914	59.30	2.335	45.50	1.791	54.10	2.130	
3.5mm, Euro Header, Vertical, Mounting ends	15	395051015	395051315	395051415	395051515	395051815	395051915	395056015	395056315	395056415	395056515	395056815	395056915	62.80	2.472	49.00	1.929	57.60	2.268	
3.5mm, Euro Header, Vertical, Mounting ends	16	395051016	395051316	395051416	395051516	395051816	395051916	395056016	395056316	395056416	395056516	395056816	395056916	66.30	2.610	52.50	2.067	61.10	2.406	
3.5mm, Euro Header, Vertical, Mounting ends	17	395051017	395051317	395051417	395051517	395051817	395051917	395056017	395056317	395056417	395056517	395056817	395056917	69.80	2.748	56.00	2.205	64.60	2.543	
3.5mm, Euro Header, Vertical, Mounting ends	18	395051018	395051318	395051418	395051518	395051818	395051918	395056018	395056318	395056418	395056518	395056818	395056918	73.30	2.886	59.50	2.343	68.10	2.681	
3.5mm, Euro Header, Vertical, Mounting ends	19	395051019	395051319	395051419	395051519	395051819	395051919	395056019	395056319	395056419	395056519	395056819	395056919	76.80	3.024	63.00	2.480	71.60	2.819	
3.5mm, Euro Header, Vertical, Mounting ends	20	395051020	395051320	395051420	395051520	395051820	395051920	395056020	395056320	395056420	395056520	395056820	395056920	80.30	3.161	66.50	2.619	75.10	2.957	

TOLERANCES			
MM	TOL	INCH	TOL
0-6	±0.25	0-.24	±.010
>6-30	±0.40	.24-1.18	±.016
>30-120	±0.50	1.18-4.76	±.020
>120	±0.80	>4.76	±.031

REVISED DOC TOL EC NO: IPG2017-0861 DRAWN: ANAGATH 2017/03/23 CHKD: APPR: BRUPERT 2017/04/18 REV DESCRIPTION	QUALITY SYMBOLS ▽=0 ▽=0	GENERAL TOLERANCES (UNLESS SPECIFIED) mm INCH 4 PLACES ± --- ± --- 3 PLACES ± --- ± --- 2 PLACES ± --- ± --- 1 PLACE ± --- ± --- ANGULAR ± ---°	DIMENSION STYLE MM/IN	SCALE INCH	DESIGN UNITS INCH	THIRD ANGLE PROJECTION	
	DRAWN BY LROTHAUS	DATE 12/6/05	TITLE 3.5MM, EURO HEADER VERTICAL, MOUNTING ENDS	CHECKED BY C. YORK	DATE 01/06/06	MATERIAL NO. SEE CHART	DOCUMENT NO. SD-39505-001
	DRAFT WHERE APPLICABLE MUST REMAIN WITHIN DIMENSIONS	APPROVED BY DATE	MOLEX INCORPORATED	SHEET NO. 2 OF 2	THIS DRAWING CONTAINS INFORMATION THAT IS PROPRIETARY TO MOLEX INCORPORATED AND SHOULD NOT BE USED WITHOUT WRITTEN PERMISSION		
	A1	B					

Description	Circuit size	Fractional Numbers											Dimensional Information							
		Black						Green					Dim. A		Dim B		Dim. C			
		100% Tin			30 UZ Gold			100% Tin			30 UZ Gold		mm		inch		mm		inch	
		Printing Options			Printing Options			Printing Options			Printing Options		mm	inch	mm	inch	mm	inch	mm	inch
3.5mm, Euro Header, Vertical, Mounting ends	2	395051002	395051302	395051402	395051502	395051802	395051902	395056002	395056302	395056402	395056502	395056802	395056902	17.30	0.681	3.50	0.138	12.10	0.478	
3.5mm, Euro Header, Vertical, Mounting ends	3	395051003	395051303	395051403	395051503	395051803	395051903	395056003	395056303	395056403	395056503	395056803	395056903	20.80	0.819	7.00	0.276	15.00	0.614	
3.5mm, Euro Header, Vertical, Mounting ends	4	395051004	395051304	395051404	395051504	395051804	395051904	395056004	395056304	395056404	395056504	395056804	395056904	24.30	0.957	10.50	0.413	19.10	0.752	
3.5mm, Euro Header, Vertical, Mounting ends	5	395051005	395051305	395051405	395051505	395051805	395051905	395056005	395056305	395056405	395056505	395056805	395056905	27.80	1.094	14.00	0.551	22.80	0.900	
3.5mm, Euro Header, Vertical, Mounting ends	6	395051006	395051306	395051406	395051506	395051806	395051906	395056006	395056306	395056406	395056506	395056806	395056906	31.30	1.232	17.50	0.689	26.10	1.028	
3.5mm, Euro Header, Vertical, Mounting ends	7	395051007	395051307	395051407	395051507	395051807	395051907	395056007	395056307	395056407	395056507	395056807	395056907	34.80	1.370	21.00	0.827	29.60	1.165	
3.5mm, Euro Header, Vertical, Mounting ends	8	395051008	395051308	395051408	395051508	395051808	395051908	395056008	395056308	395056408	395056508	395056808	395056908	38.30	1.508	24.50	0.965	33.10	1.303	
3.5mm, Euro Header, Vertical, Mounting ends	9	395051009	395051309	395051409	395051509	395051809	395051909	395056009	395056309	395056409	395056509	395056809	395056909	41.80	1.646	28.00	1.102	36.60	1.441	
3.5mm, Euro Header, Vertical, Mounting ends	10	395051010	395051310	395051410	395051510	395051810	395051910	395056010	395056310	395056410	395056510	395056810	395056910	45.30	1.783	31.50	1.240	40.10	1.579	
3.5mm, Euro Header, Vertical, Mounting ends	11	395051011	395051311	395051411	395051511	395051811	395051911	395056011	395056311	395056411	395056511	395056811	395056911	48.80	1.921	35.00	1.378	43.60	1.717	
3.5mm, Euro Header, Vertical, Mounting ends	12	395051012	395051312	395051412	395051512	395051812	395051912	395056012	395056312	395056412	395056512	395056812	395056912	52.30	2.059	38.50	1.516	47.10	1.854	
3.5mm, Euro Header, Vertical, Mounting ends	13	395051013	395051313	395051413	395051513	395051813	395051913	395056013	395056313	395056413	395056513	395056813	395056913	55.80	2.197	42.00	1.654	50.60	1.992	
3.5mm, Euro Header, Vertical, Mounting ends	14	395051014	395051314	395051414	395051514	395051814	395051914	395056014	395056314	395056414	395056514	395056814	395056914	59.30	2.335	45.50	1.791	54.10	2.130	
3.5mm, Euro Header, Vertical, Mounting ends	15	395051015	395051315	395051415	395051515	395051815	395051915	395056015	395056315	395056415	395056515	395056815	395056915	62.80	2.472	49.00	1.929	57.60	2.268	
3.5mm, Euro Header, Vertical, Mounting ends	16	395051016	395051316	395051416	395051516	395051816	395051916	395056016	395056316	395056416	395056516	395056816	395056916	66.30	2.610	52.50	2.067	61.10	2.406	
3.5mm, Euro Header, Vertical, Mounting ends	17	395051017	395051317	395051417	395051517	395051817	395051917	395056017	395056317	395056417	395056517	395056817	395056917	69.80	2.748	56.00	2.205	64.60	2.543	
3.5mm, Euro Header, Vertical, Mounting ends	18	395051018	395051318	395051418	395051518	395051818	395051918	395056018	395056318	395056418	395056518	395056818	395056918	73.30	2.886	59.50	2.343	68.10	2.681	
3.5mm, Euro Header, Vertical, Mounting ends	19	395051019	395051319	395051419	395051519	395051819	395051919	395056019	395056319	395056419	395056519	395056819	395056919	76.80	3.024	63.00	2.480	71.60	2.819	
3.5mm, Euro Header, Vertical, Mounting ends	20	395051020	395051320	395051420	395051520	395051820	395051920	395056020	395056320	395056420	395056520	395056820	395056920	80.30	3.161	66.50	2.619	75.10	2.957	

TOLERANCES			
MM	TOL	INCH	TOL
0-6	±0.25	0-.24	±.010
>6-30	±0.40	.24-1.18	±.016
>30-120	±0.50	1.18-4.76	±.020
>120	±0.80	>4.76	±.031

REVISED DOC TOL EC NO: IPG2017-0861 DRAWN: ANAGATH 2017/03/23 CHKD: APPR: BRUPERT 2017/04/18 REV DESCRIPTION	QUALITY SYMBOLS ▽=0 ▽=0	GENERAL TOLERANCES (UNLESS SPECIFIED) mm INCH 4 PLACES ± --- ± --- 3 PLACES ± --- ± --- 2 PLACES ± --- ± --- 1 PLACE ± --- ± --- ANGULAR ± ---°	DIMENSION STYLE MM/IN DRAWN BY DATE LROTHAUS 12/6/05 CHECKED BY DATE C. YORK 01/06/06 APPROVED BY DATE	SCALE DESIGN UNITS INCH THIRD ANGLE PROJECTION
	DRAFT WHERE APPLICABLE MUST REMAIN WITHIN DIMENSIONS		MATERIAL NO. SEE CHART	TITLE 3.5MM, EURO HEADER VERTICAL, MOUNTING ENDS
	SIZE B		DOCUMENT NO. SD-39505-001	SHEET NO. 2 OF 2
	THIS DRAWING CONTAINS INFORMATION THAT IS PROPRIETARY TO MOLEX INCORPORATED AND SHOULD NOT BE USED WITHOUT WRITTEN PERMISSION			