

THIS DOCUMENT CONTAINS DATA PROPRIETARY TO PROJECTS UNLIMITED, INC. ANY USE OR REPRODUCTION, IN ANY FORM, WITHOUT PRIOR WRITTEN PERMISSION OF PROJECTS UNLIMITED, INC. IS PROHIBITED.
© 2005, Projects Unlimited Inc.

SPECIFICATIONS

PARAMETERS	VALUES	UNITS
RATED INPUT POWER	0.3	W
MAX INPUT POWER	0.5	W
IMPEDANCE	25±15%	OHM
OUTPUT SPL @ 0.1W/0.1M (AT 0.8, 1.0, 1.2, 1.5 kHz)	86±3	dBA
DISTORTION (MAX.)	5%	-
RESONANT FREQUENCY	850±20%	Hz
FREQUENCY RANGE	Fo ~ 20,000	Hz
HOUSING MATERIAL	PBT	-
CONE MATERIAL	MYLAR	-
MAGNET MATERIAL	NdFeB	-
OPERATING TEMPERATURE	-30 ~ +70	°C
WEIGHT	1.5	grams

REVISIONS			
LTR	DESCRIPTION	DATE	APPROVED
-	RELEASED FROM ENGINEERING	1/28/15	

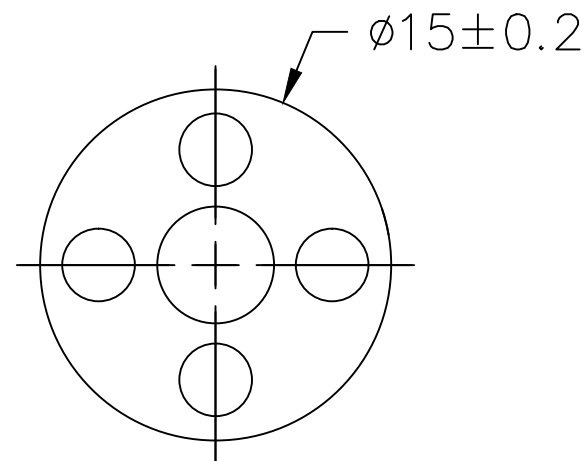
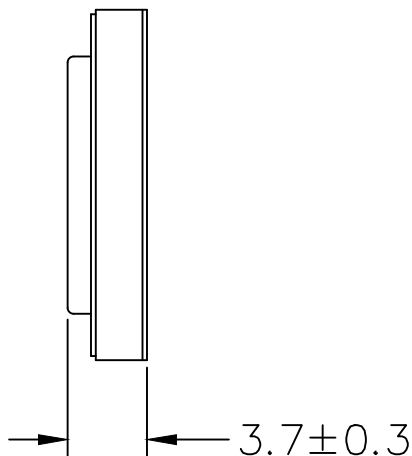
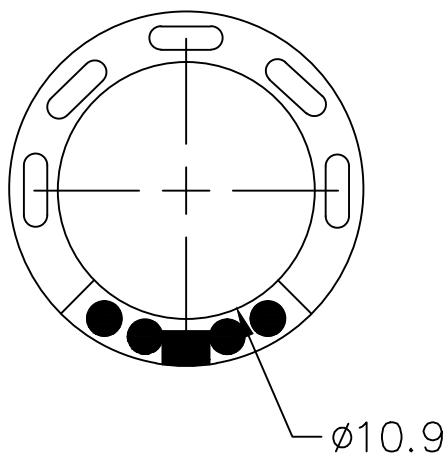

NOTES:

1. ALL DIMENSIONS ARE IN MILLIMETERS.
2. SPECIFICATION SUBJECT TO CHANGE OR WITHDRAWAL WITHOUT NOTICE.
3. THIS PART IS RoHS 2011/65/EU COMPLIANT.

FILE NAME
AS01525MR-R.DWG

UNLESS OTHERWISE SPECIFIED: ALL PURCHASES ARE SUBJECT TO THE PUI TERMS AND CONDITIONS SALE FOUND AT: http://www.puiaudio.com/pdf/terms_conditions.pdf (paper copy available upon request)		 <p>pui audio^{inc} a projects unlimited company</p>	3541 Stop Eight Road Dayton, Ohio 45414
DIMENSIONS ARE IN MILLIMETERS, TOLERANCES ARE ±0.5 AND ANGLES ARE ±3°.			
APPROVALS		DATE	<h2>SPEAKER</h2>
DRAWN	M.L.	1/15	
CHECKED	M.L.	1/15	
APPROVED	B.R.	1/15	SIZE: A DRAWING NO.: AS01525MR-R SCALE: N.T.S.
			SHEET 1 OF 1