

PART NUMBER **BL23E22-02-HP05**

**MOTOR SPECIFICATIONS**

Part Number	<b>BL23E22-02</b>
Dimension "A"	2.19 in   55.5 mm
Rated Voltage	48 VDC
Rated Torque	20.53 oz-in   0.145 N-m
Rated Speed	4000 RPM
Rated Power	60 Watts
Rated Current	1.6 Amps
Peak Torque	41.07 oz-in   0.29 N-m
Peak Current	3.2 Amps
Torque Constant (kt)	12.74 oz-in/Amp
Back EMF Constant (Ke)	8.95 Vp/KRPM
Motor Constant (Km)	9.5 oz-in/√W   0.067 N-m/√W
Resistance	1.8 Ohms
Inductance	1.9 mH
Rotor Inertia	0.81 oz-in <sup>2</sup>
Weight	1.41lb   0.64 kg
Electrical Time Constant	1.1 ms
Mechanical Time Constant	3.5 ms

**GEARBOX SPECIFICATIONS**

Part Number	<b>HP05</b>
Ratio	5:1
Nominal Output Torque (Nm)	60
Emergency Stop Torque (Nm)	3 times nominal output torque
Nominal Input Speed (RPM)	5000
Max Input Speed (RPM)	10000
Max Radial Load (N)	1377
Max Axial Load (N)	765
Efficiency η (%)	90
Backlash (arcmin)	<5
Protection Class	IP65 (gearbox), IP40 (motor)
Service Life (hr)	20000
Weight (kg)	1.4
Operating Temperature (°C)	-20 to 90
Lubrication	Grease
Noise (n=3000 rpm) dB(A)	56
Mass Movement of Inertia (kg-cm <sup>2</sup> )	0.13



**PERFORMANCE CURVE**

**BL23E22-02 GEARMOTOR TORQUE CURVES**

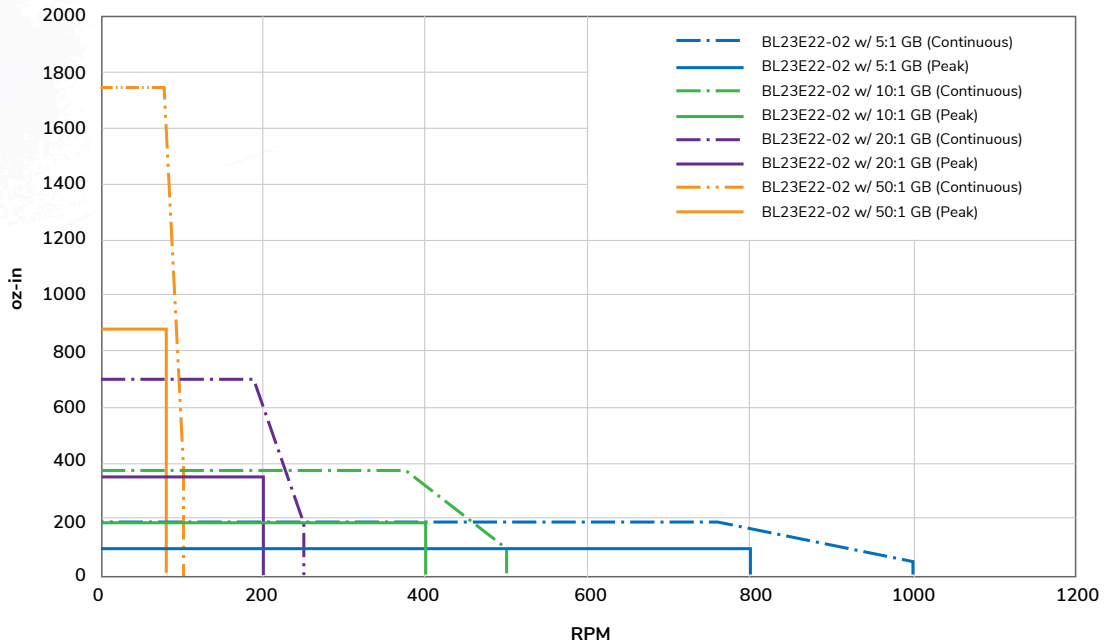

## DIMENSIONS

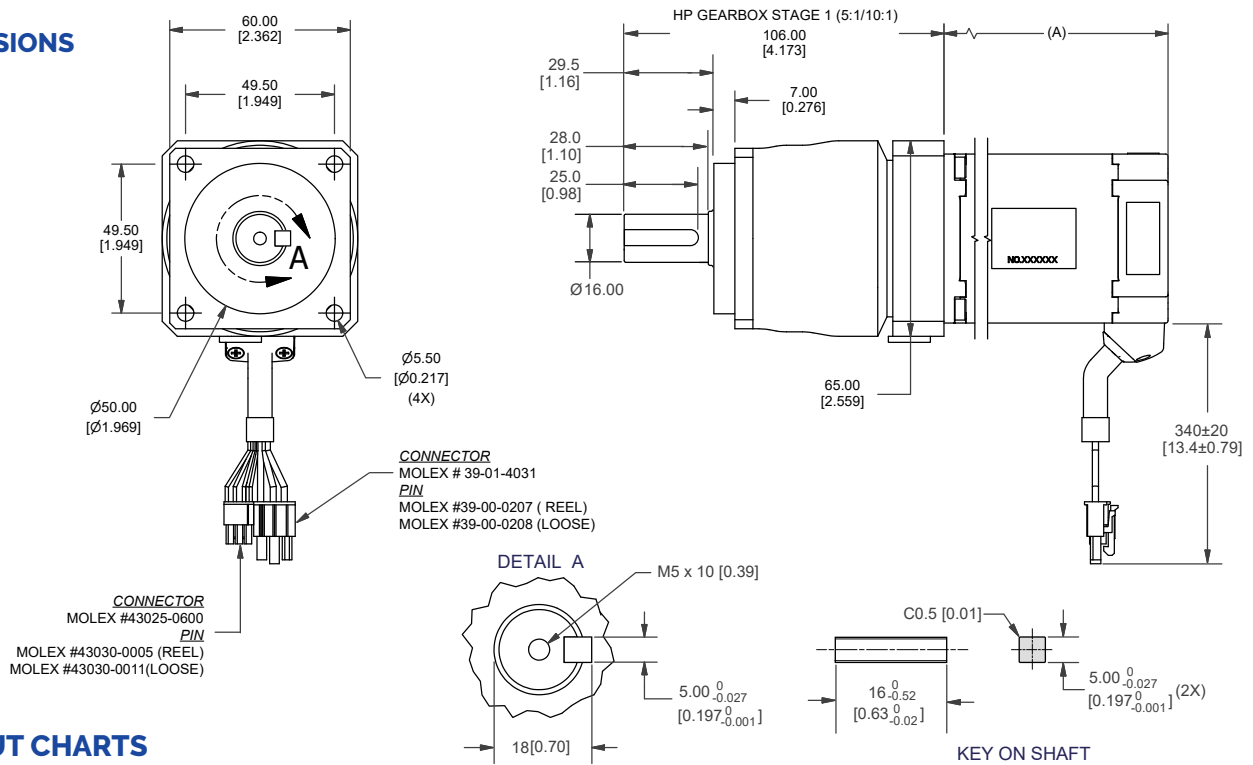

## PIN OUT CHARTS

PIN #	COLOR	PHASE
1	RED	VCC (+5V)
2	YELLOW	HV
3	BLUE	HW
4	BLACK	GND
5	ORANGE	HU

PIN #	COLOR	PHASE
1	BLUE	W
2	ORANGE	U
5	YELLOW	V

## RECOMMENDED PRODUCTS



BLDC DRIVER  
BLDC50-BL23E22-02



BLDC EXTENSION CABLE  
4201-100/300

## OPERATION & USAGE TIPS

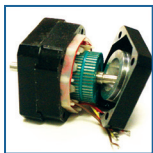

**Do not** disassemble motors; a significant reduction in motor performance will occur.

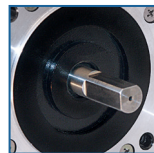

**Do not** machine shafts; this will have a negative effect on shaft run out and perpendicularity.

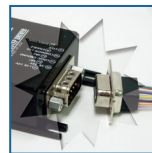

**Do not** disconnect motor from drive while in operation.

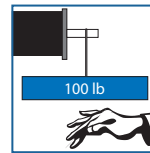

**Do not** use holding torque/detent torque of motor as a fail safe brake.

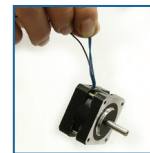

**Do not** hold motor by lead wires.



**Do not** exceed the rated current; this will damage the motor.

FAILURE TO COMPLY WITH THESE RECOMMENDATIONS WILL VOID ALL WARRANTY TERMS

# Motion Control, Solved.

## MOTOR ENGINEERING & MANUFACTURING



Optimized  
For Your  
Application



Quick  
Prototype  
Turnaround



Small Batch  
to OEM Volume  
Production



US Based  
Support &  
Manufacturing