

Process Sealed Sub-Miniature Toggle

Specifications

Electrical Ratings	.4VA max @ 20VAC or VDC max	Insulation Resistance	≥500MΩ min
Electrical Life	40,000 cycles typical	Operating Temperature	-40°C to 85°C
Contact Resistance	≤100mΩ initial	Storage Temperature	-40°C to 85°C
Actuation Force	150 ± 50gF	Sealing Degree	IP67
Dielectric Strength	500Vrms min between contacts		

Materials

Actuator	6/6 Nylon, Glass Filled, Flame Retardant, Heat Stabilized, UL94V-0
Housing	6/6 Nylon, Glass Filled, Flame Retardant, Heat Stabilized, UL94V-0
Bracket	Steel, Tin Plated
Contacts	Copper Alloy, Gold over Nickel Plated
Terminals	Copper Alloy, Gold over Nickel Plated

Ordering Information

1. Series	CST	1	1	T	2	C	R
CST							
2. Number of Poles							
1 = Single Pole							
2 = Double Pole							
3. Switch Function							
0 = Off-None- On							
1 = On-None-On							
3 = On-Off-On							
4. Actuator							
T = Standard toggle, 3.80mm							
5. Actuator Color							
2 = Black, standard							
6. Terminals							
C = PC pin							
H = Horizontal mount, right angle PC pin							
V = Vertical mount, right angle PC pin							
7. Contact Material							
R = Gold plated							

Switch Function



SPST NO



FUNCTION	TOGGLE POSITION		
0	OFF	NONE	ON
TERMINALS	--	--	4-6

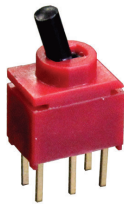
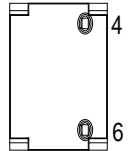
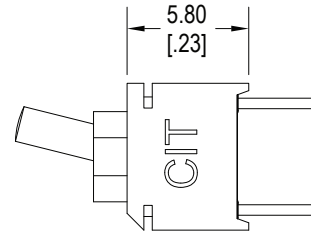
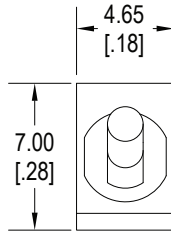

SPDT

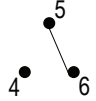

FUNCTION	TOGGLE POSITION		
1	ON	NONE	ON
3	ON	OFF	ON
TERMINALS	5-6	--	5-4

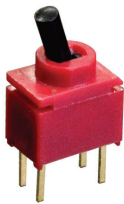
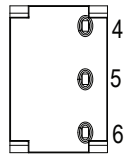
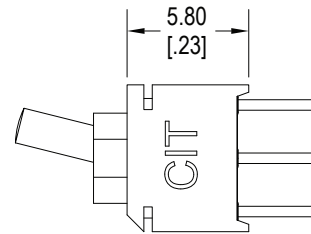
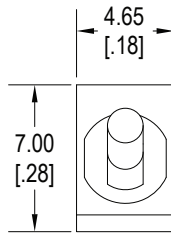

DPST NO

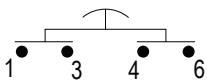

FUNCTION	TOGGLE POSITION		
0	OFF	NONE	ON
TERMINALS	--	--	1-3-4-6

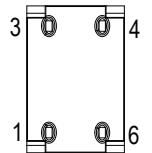
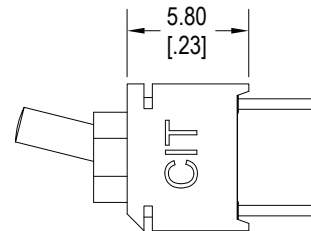
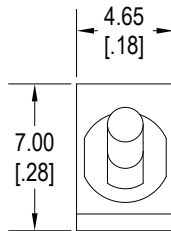

DPDT

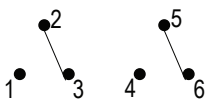

FUNCTION	TOGGLE POSITION		
1	ON	NONE	ON
3	ON	OFF	ON
TERMINALS	2-3-5-6	--	2-1-5-4

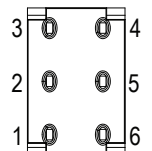
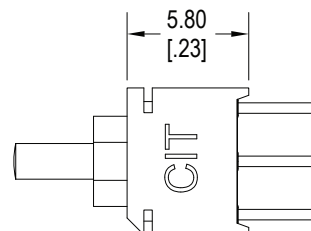
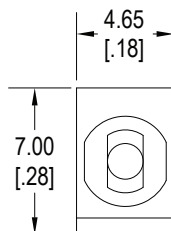

Actuator

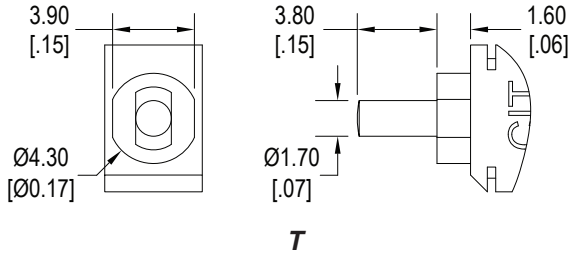

Terminal Options

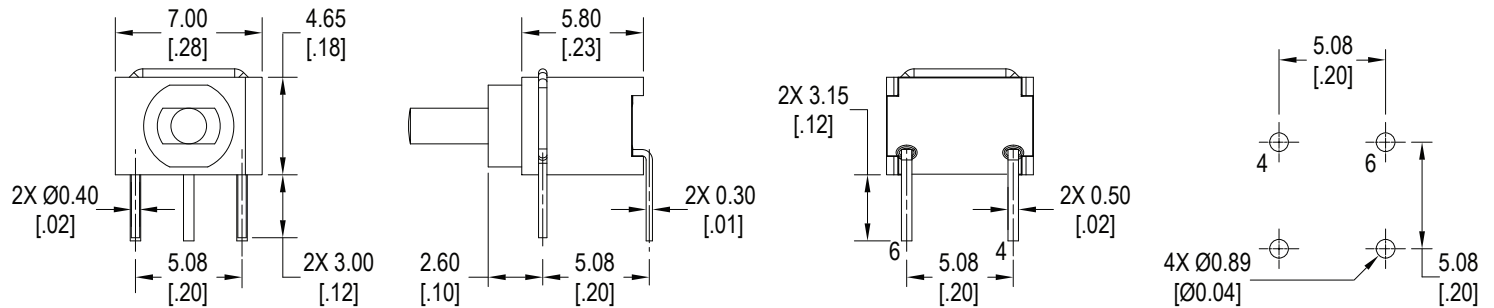
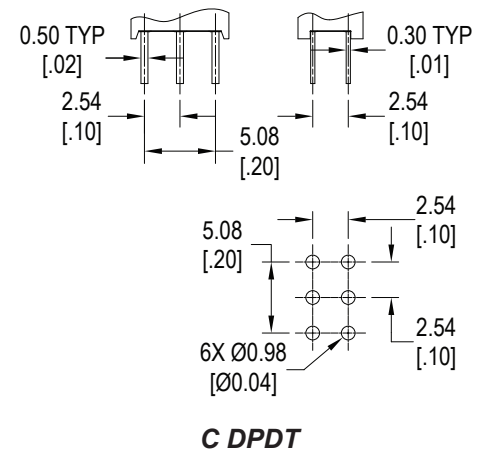
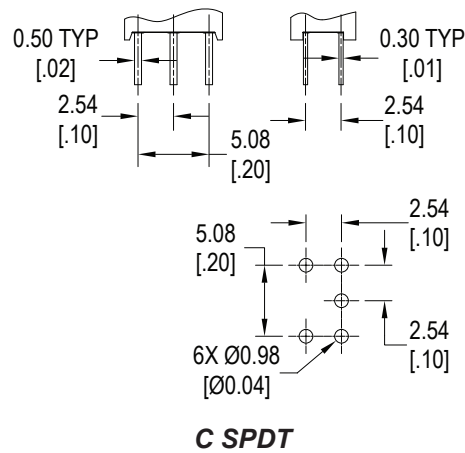
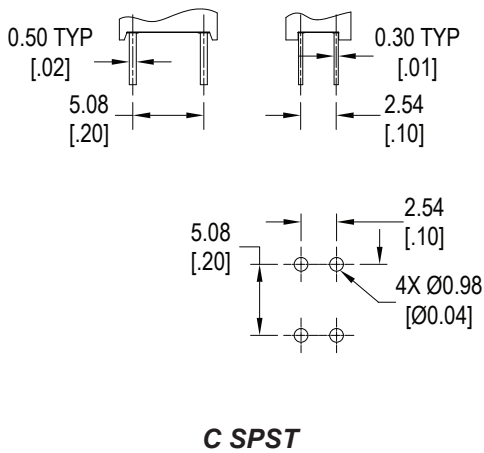

H = Horizontal mount, right angle PC pins, SPST N.O.

Terminal Options

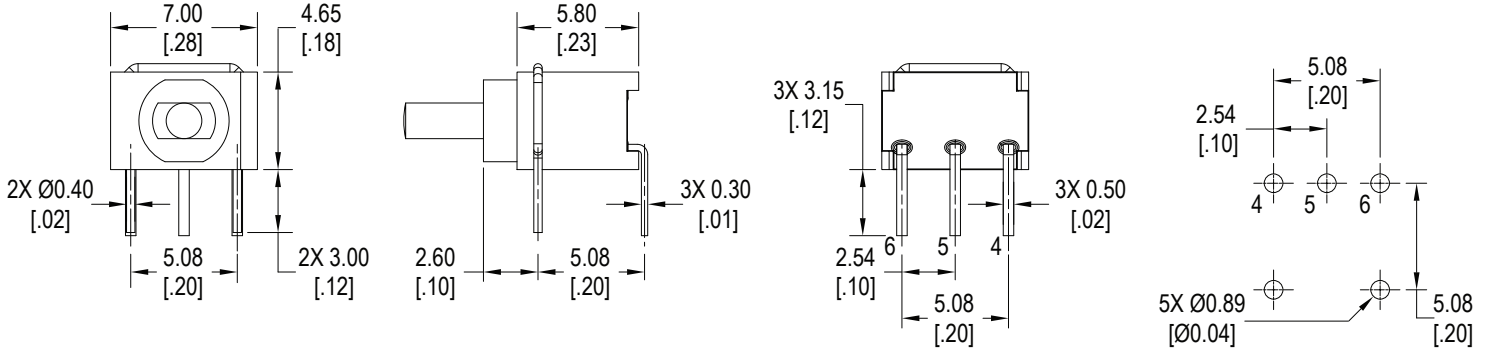

H = Horizontal Mount, right angle PC pins, SPDT

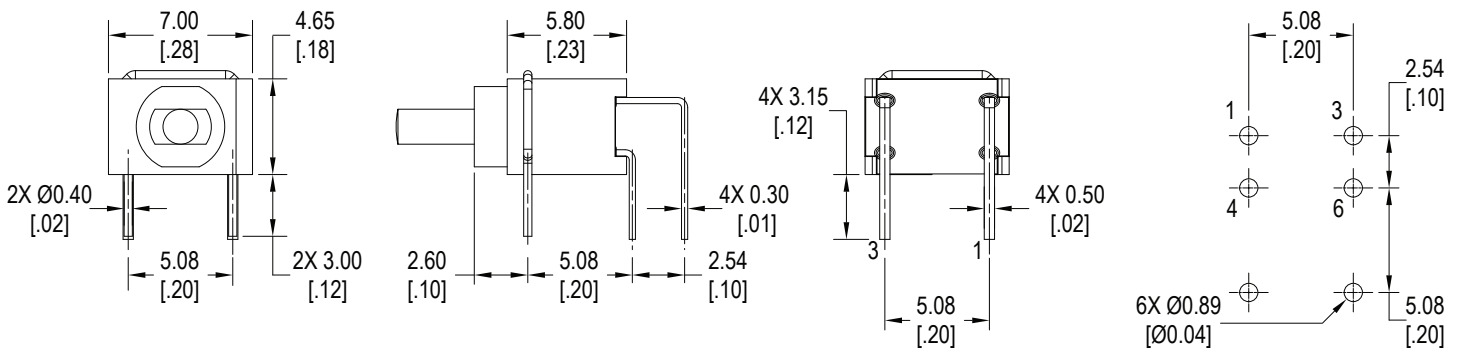

H = Horizontal mount, right angle PC pins, DPST N.O.

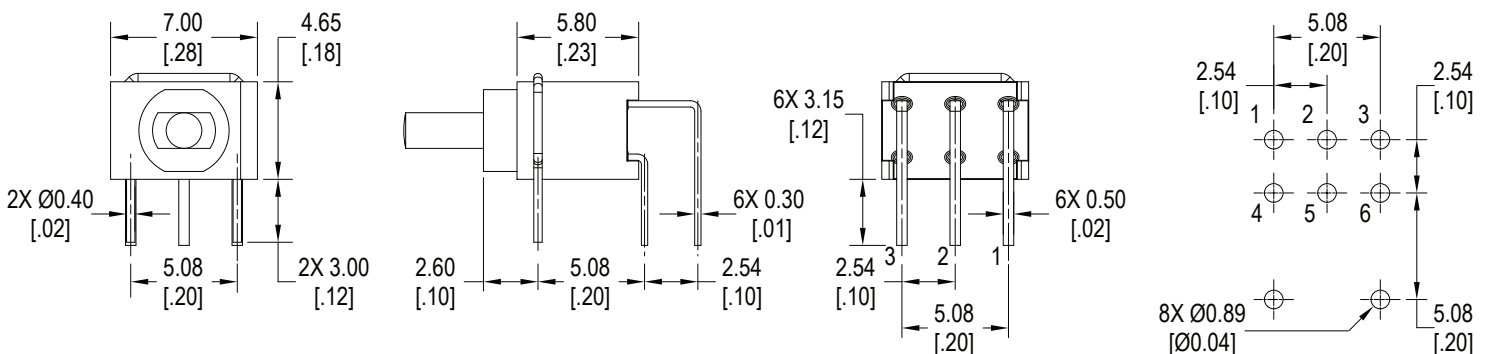

H = Horizontal mount, right angle PC pins, DPDT

Terminal Options

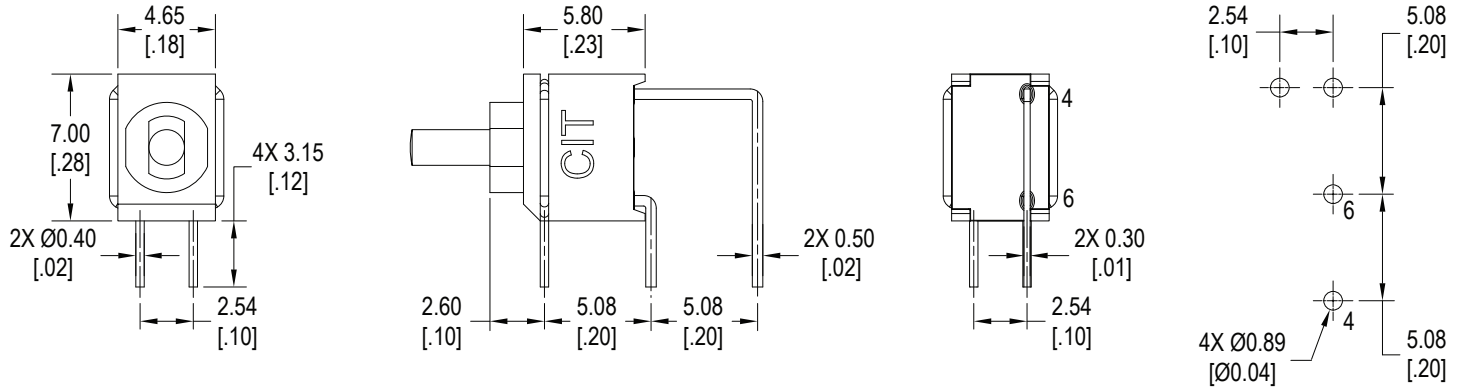

V = Vertical mount, right angle PC pins, SPST N.O.

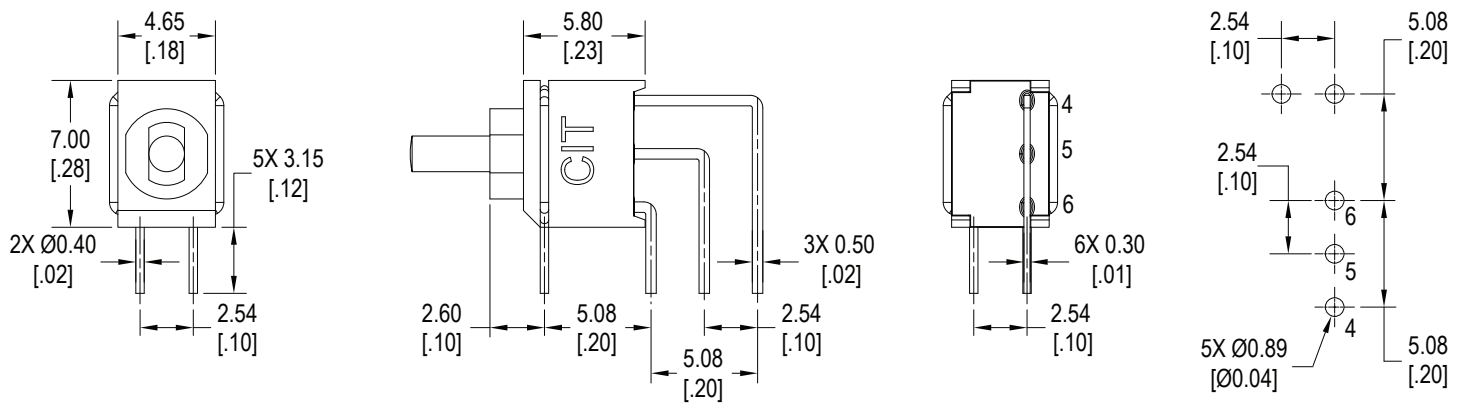

V = Vertical Mount, right angle PC pins, SPDT

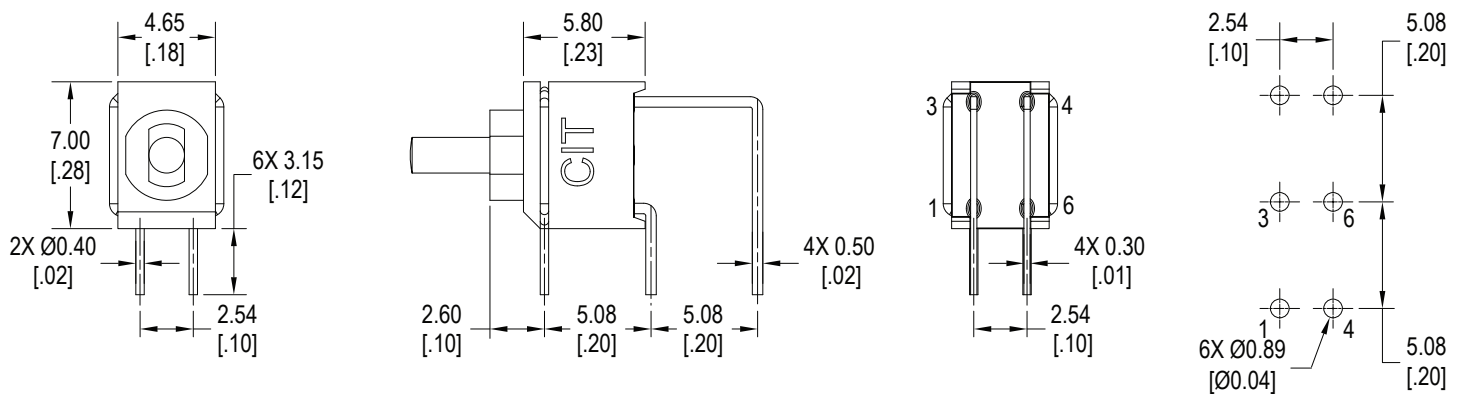

V = Vertical mount, right angle PC pins, DPST N.O.

Terminal Options

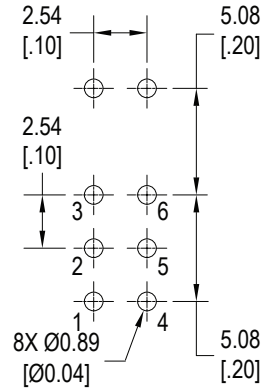
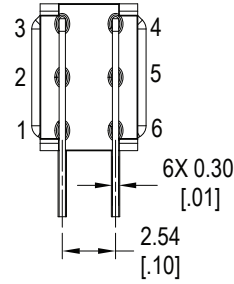
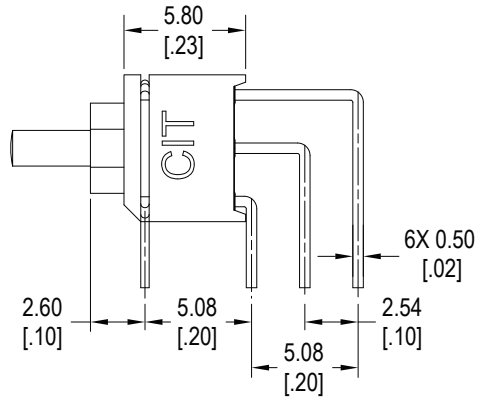
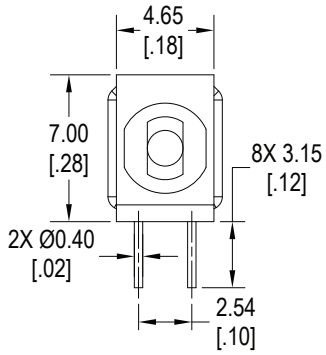

V = Vertical mount, right angle PC pins, DPDT