

1. MECHANICAL DIMENSIONS :

REV.	DATE	DESCRIPTION
01	Dec. 11 '17	1st RELEASE

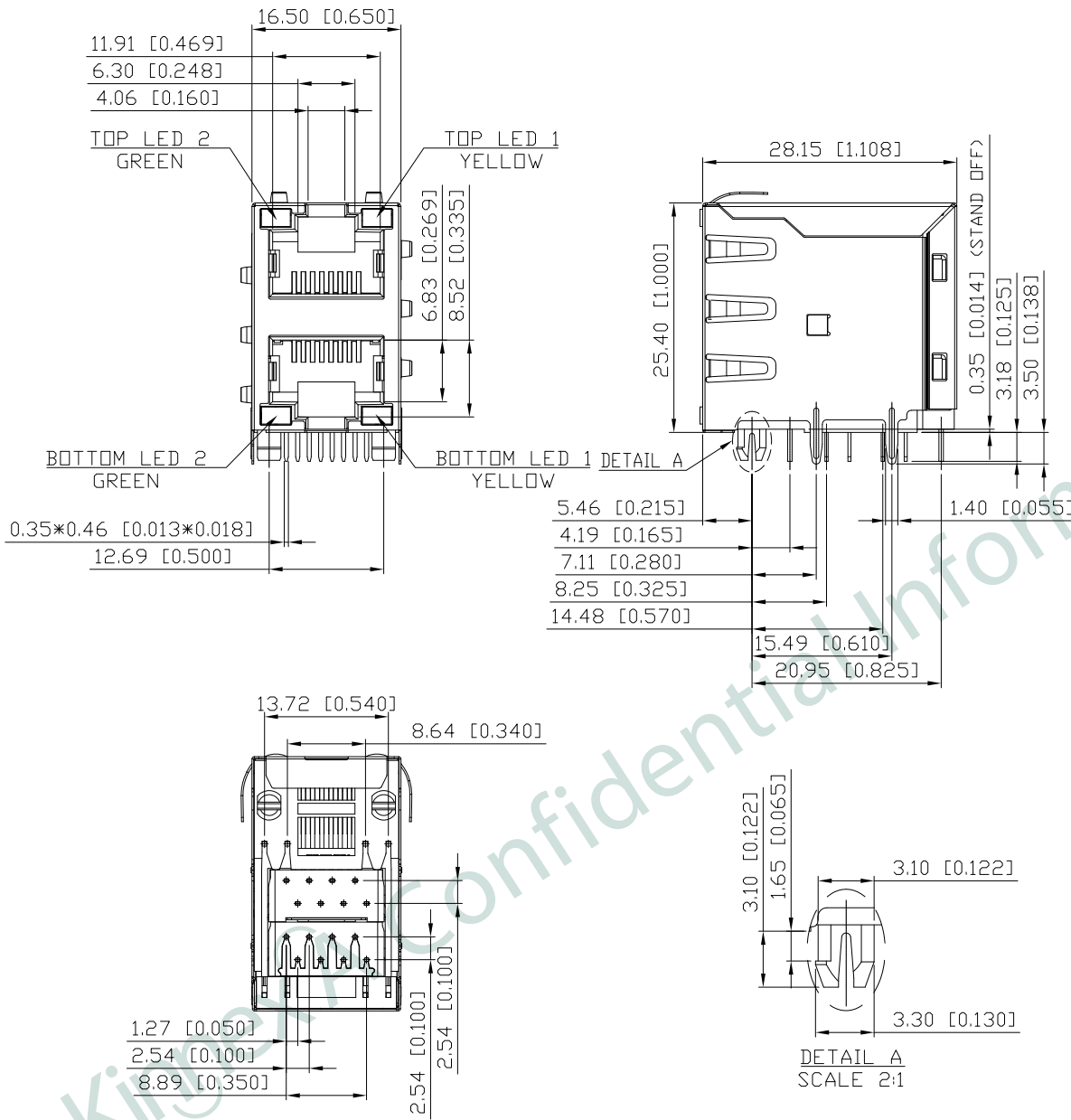

NOTES:

- MATERIAL:
HOUSING: HIGH THERMOPLASTIC, UL94V-0, BLACK
CONTACTS: T=0.35mm PHOS-BRONZE,
6u" GOLD PLATING ON CONTACT AREA,
NICKEL UNDERPLATING OVERALL
SHIELD: COPPER ALLOY, NICKEL PLATING
- OPERATING TEMPERATURE: -40°C~+85°C
- INSERTION FORCE: 4 POUNDS MAX.
EXTRACTION FORCE: 4 POUNDS MAX.
- DURABILITY: 750 MATING CYCLED MIN.
- CAVITY CONFORMS TO FCC RULES AND REGULATIONS PART 68,
SUBPART F.
- UNSPECIFIED TOLERANCE: .XX ±0.25[0.010]
.X ±0.35[0.014]

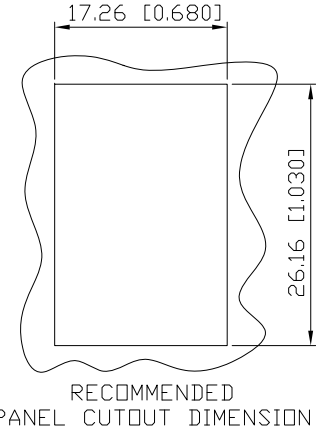

PART NO		KRD-S-21-8-8-4-1DD		
TITLE	RJ45 2X1 8P8C, W/LED, SHIELDED, STACKED TYPE			
REV : 01				
UNIT	DRAWN	CHKD	DATE	SHEET
mm[inch]	CINDY	DANIEL	Dec. 11, '17	1 of 3

2. PCB LAYOUT :

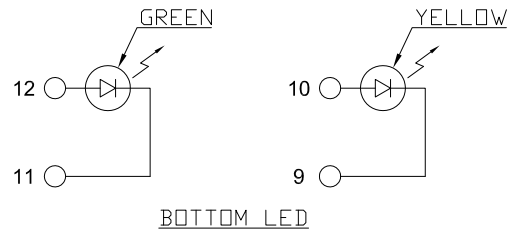
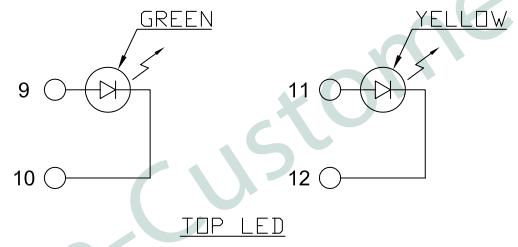
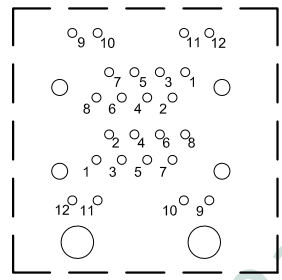
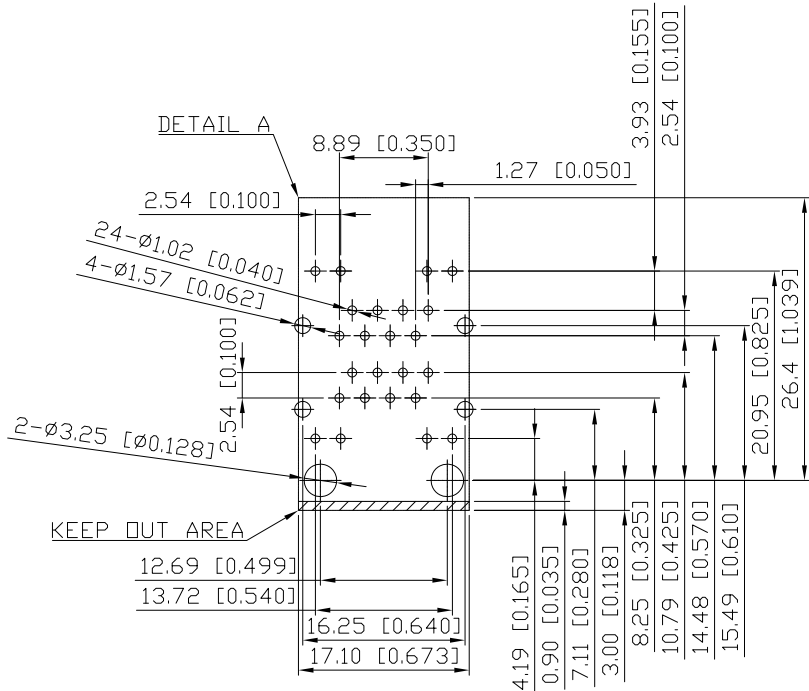

SUGGESTED PCB LAYOUT
(TOP VIEW)
DIMENSIONAL TOLERANCE: .XX ±0.08[0.003]

COLOR	VF(V) @20mA		IV(mcd) @20mA		PEAK WAVE LENGTH λP(nm) @20mA
	TYP	MAX	TYP	TYP	
GREEN	2.0	2.4	45	20	570
YELLOW	2.0	2.4	100	20	587

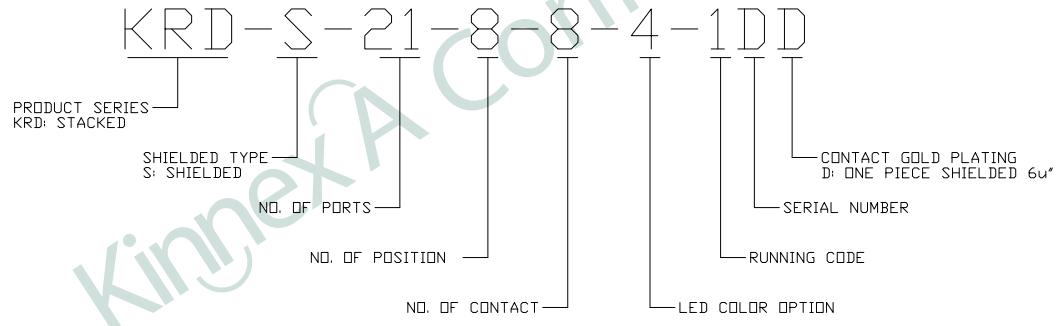

PART NO KR D-S-21-8-8-4-1DD				
TITLE	RJ45 2X1 8P8C, W/LED, SHIELDED, STACKED TYPE			
REV : 01				
UNIT	DRAWN	CHKD	DATE	SHEET
mm[inch]	CINDY	DANIEL	Dec. 11, '17	2 of 3

DWG NO KR D-S-21-8-8-4-1DD

KinnexA, INC. 8F, No. 172, CHENG TEH ROAD SEC. 4, TAIPEI 11167, TAIWAN



PRELIMINARY RELEASE SUBJECT TO CHANGE

※ THIS DRAWING IS A CONTROLLED DOCUMENT ※

RoHS Compliant

3. PROFILE OF WAVE SOLDER :

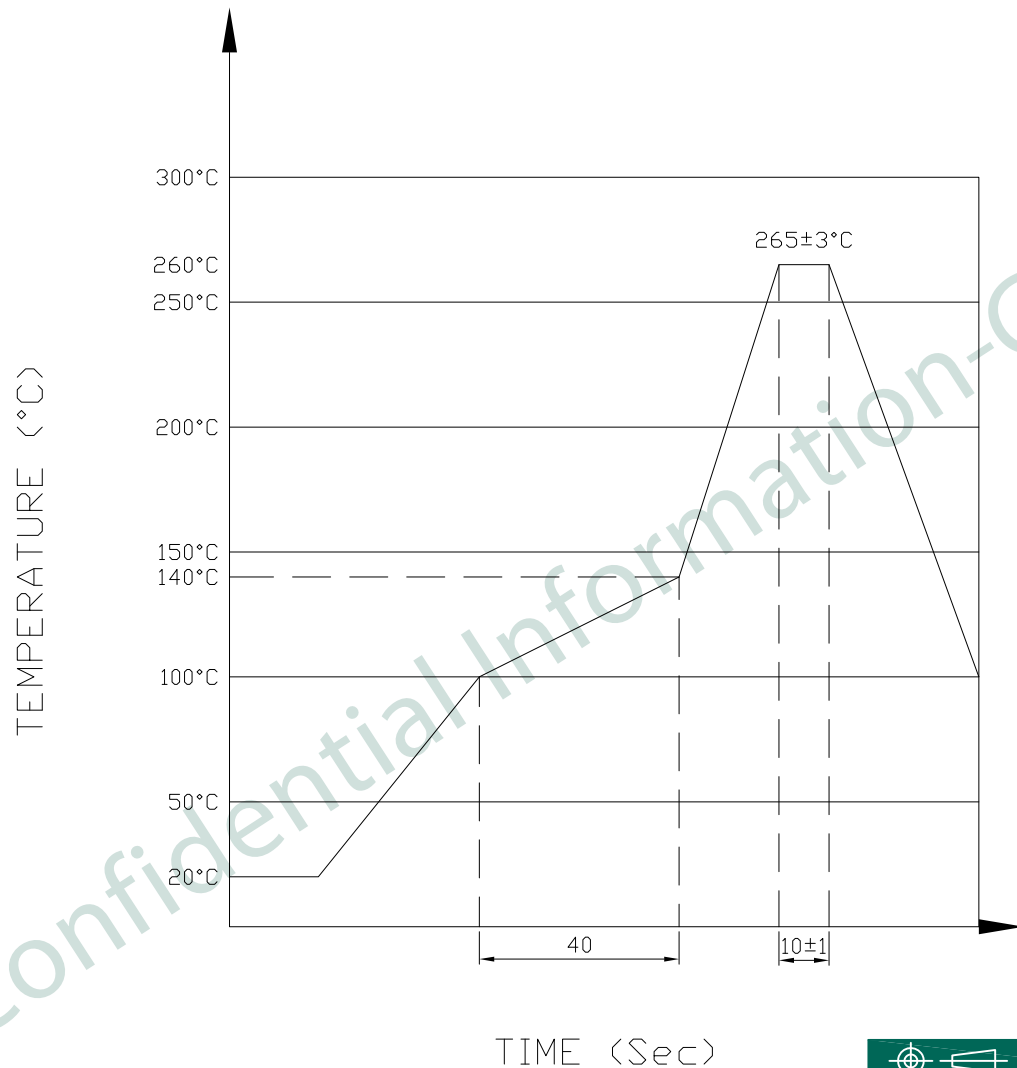

The measuring point for the specified temperature shall be on the soldered part of the lead

PART NO KRD-S-21-8-8-4-1DD				
TITLE	RJ45 2X1 8P8C, W/LED, SHIELDED, STACKED TYPE			
REV : 01				
UNIT	DRAWN	CHKD	DATE	SHEET
mm[inch]	CINDY	DANIEL	Dec. 11, '17	3 of 3