

Specification

- Part No. : **MA104.C.W.AB.002**
- Product Name : MA104 2in1 Combination Hercules GPS/GALILEO & Cellular Screw-mount (Permanent mount)
- Feature : Low profile - Height 29 mm and Diameter 49mm
Heavy duty Permanent mount
UV and vandal resistant PC housing
GPS/GALILEO - Two Stage 28dB+ LNA
Cellular -Penta Band Antenna
850/900/1800/1900/2100/1575.42 MHz
Cables: 3 metres RG-174 on GPS, CFD-200 on Cellular
Connector: SMA(M)ST
White Version
RoHS & REACH Compliant



1. Introduction

The MA104.C.W GPS/Galileo & Cellular 2in1 Combination Hercules Antenna is a combination high performance GPS/GALILEO and penta-band cellular antenna solution for reliable asset tracking and remote monitoring. Durable UV and robust PC housing is resistant to vandalism and direct attack. At only 29 mm height it complies with the latest EU height restrictions directives for roof-mounted objects, with a diameter of 49 mm.

It is designed to not catch on tree-branches.

The Hercules can be mounted on metal or non-metal structures as it has a metal ground-plane base integrated inside. The MA104 is also available in Black.

2. Specification

ELECTRICAL CELLULAR						
Standard		AMPS	GSM	PCS	DCS	3G
Band (MHz)		850	900	1900	1800	2100
Frequency (MHz)		824-896	880-960	1850-1990	1710-1880	1920 –2170
Return Loss (dB)						
Cable length (meter)	0.3	-6.5	-6.0	-7	-8	-5
	1.0	-9.5	-8	-17	-16	-15
	2.0	-10	-9	-20	-21	-18
	3.0	-13	-11	-21	-21	-19
	5.0	-14	-14	-25	-25	-23
Efficiency (%)						
Cable length (meter)	0.3	38	54	58	54	50
	1.0	31	35	36	42	31
	2.0	23	20	23	32	21
	3.0	25	29	23	22	18
	5.0	11	11.5	12	11	11
Peak Gain (dBi)						
Cable length (meter)	0.3	2.0	3.3	4.0	3.6	3.0
	1.0	1.2	1.3	2	1.8	1.2
	2.0	0.5	-0.35	0	1.5	-0.1
	3.0	0.1	1.6	0.6	0.1	-0.9
	5.0	-2.5	-2.4	-2.3	-3.0	-2.0
Polarization	Linear					
Impedance	50 Ohms					
Input Power	10 Watts max.					
VSWR	<3.5.0:1					

ELECTRICAL GPS/GALILEO			
Frequency	1575.42MHz ± 1.023MHz		
Impedance	50 ohm		
VSWR	2.0 Max		
GPS/GALILEO Patch Gain	2.0dB Passive Gain @ Zenith -1.0dBi Gain @ 10 degrees elevation		
Axial ratio	3.0 dB max		
Polarization	RHCP		
Out Band Rejection	fo = 1575.42MHz fo ± 30 MHz 5dB Min. fo ± 50 MHz 20dB Min. fo ± 100 MHz 25dB Min.		
Input Voltage	Min:1.8V	Typ. 3.0V	Max: 5.5V
Total Gain @ Zenith	25dBic	30dBic	32dBic
Current Consumption	6mA	12mA	30mA
Noise Figure	2.7dB	3.0dB	3.7dB
MECHANICAL			
Dimensions	Height 28.5mm x Diameter 47.8mm		
Casing	White PC		
Base and thread	Nickel plated steel		
Thread diameter	18mm		
Weather proof gasket	DP-3060W foam with 3M9448HK double-side adhesive		
Cable pull	8 Kgf		
Recommended Mounting Torque	24.5N·m		
Maximum Mounting Torque	29.4N·m		
ENVIRONMENTAL			
Corrosion	5% NaCl for 48hrs - Nickel plated steel base and thread		
Temperature Range	-40°C to +85°C		
Thermal Shock	100 cycles -40°C to +85°C		
Humidity	Non-condensing 65°C 95% RH		
Shock (drop test)	1m drop on concrete 6 axes		

*Note: The return loss, efficiency and gain measurements in the above table, were taken for the antenna mounted on a 30x30 cm metal plate. For a specific case performance refers to the below plots.

3. Test Setup

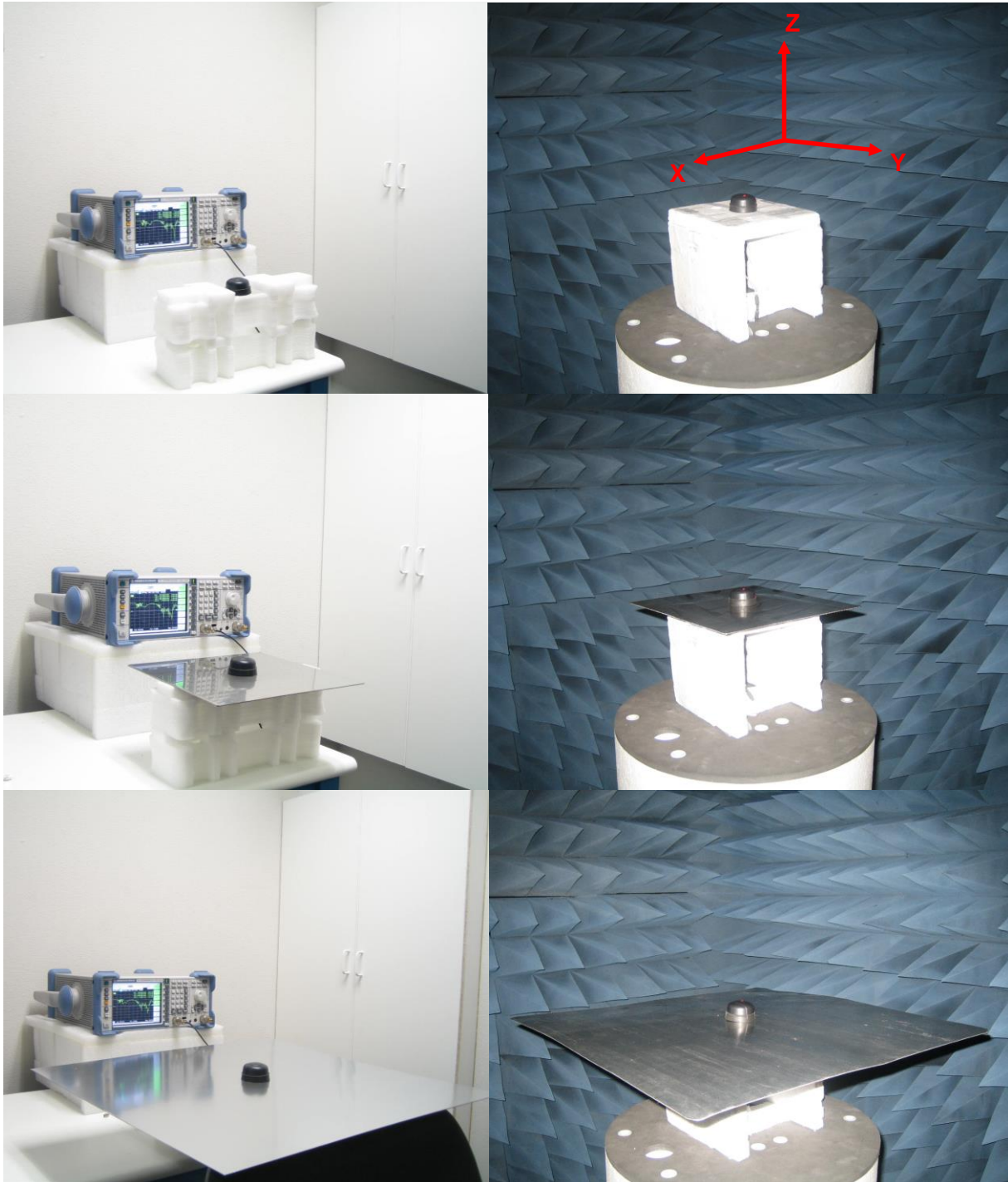

Figure 1. MA104 Antenna test set up in free space, 30x30 cm metal plate and 60x60 cm metal plate, R&SZVL6 VNA (left) and R&S4100 CTIA 3D Chamber (Right).

4. Antenna Parameters

4.1 Return Loss

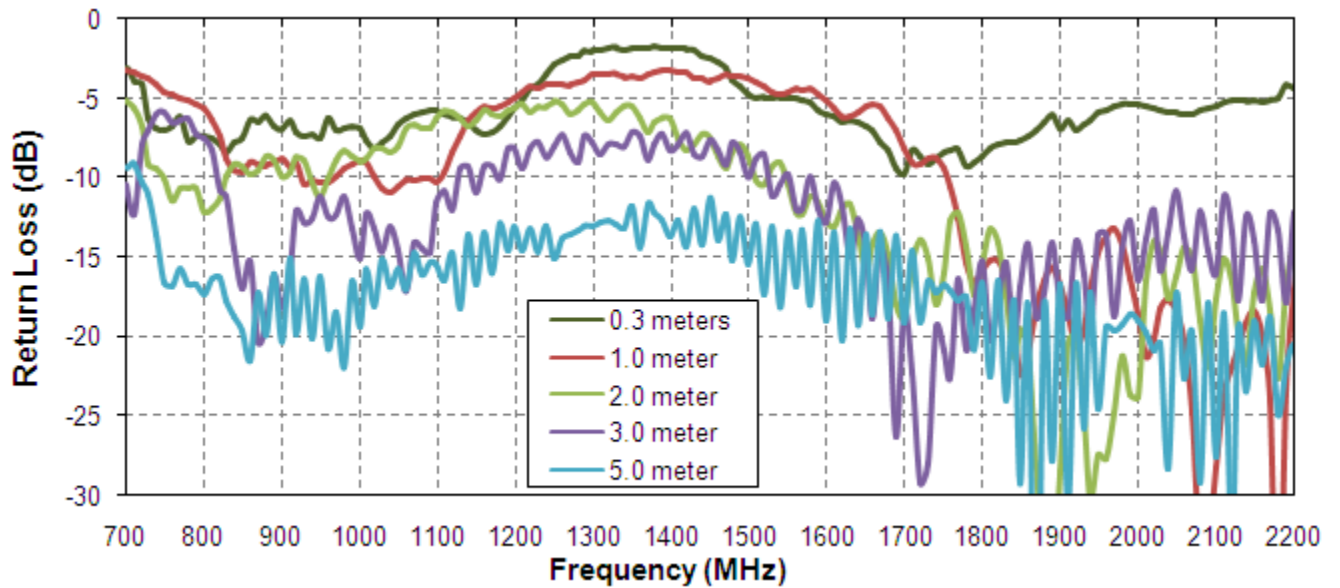

Figure 2. Return Loss of the MA104 antenna in free space

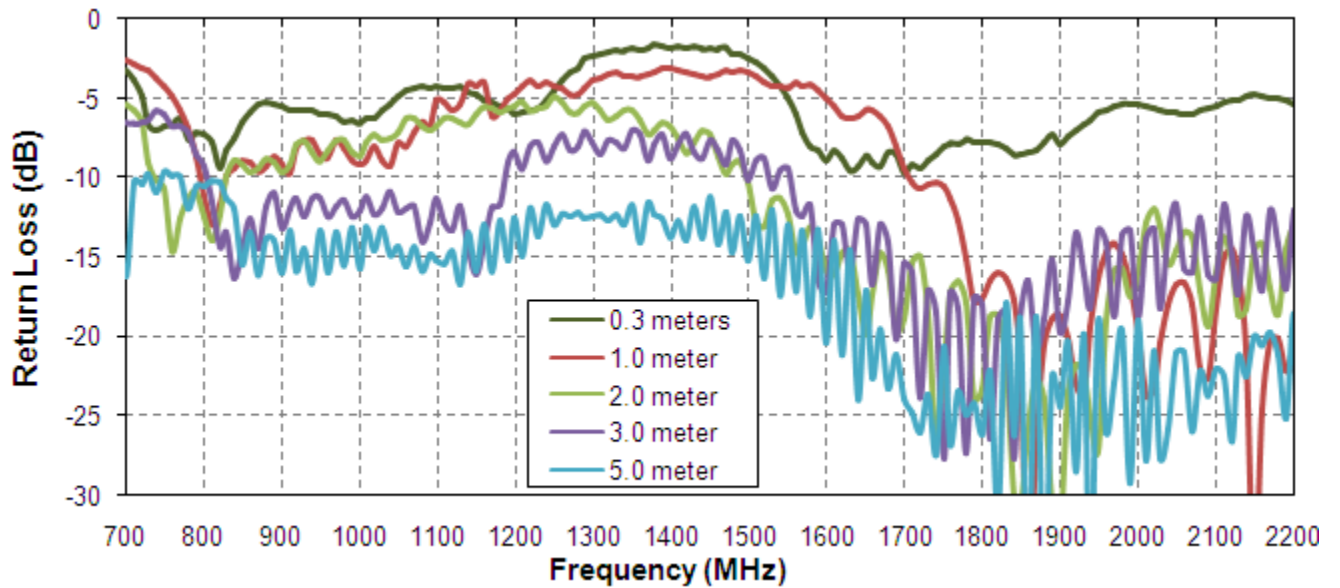

Figure 3. Return Loss of the MA104 antenna on 30*30cm metal plate

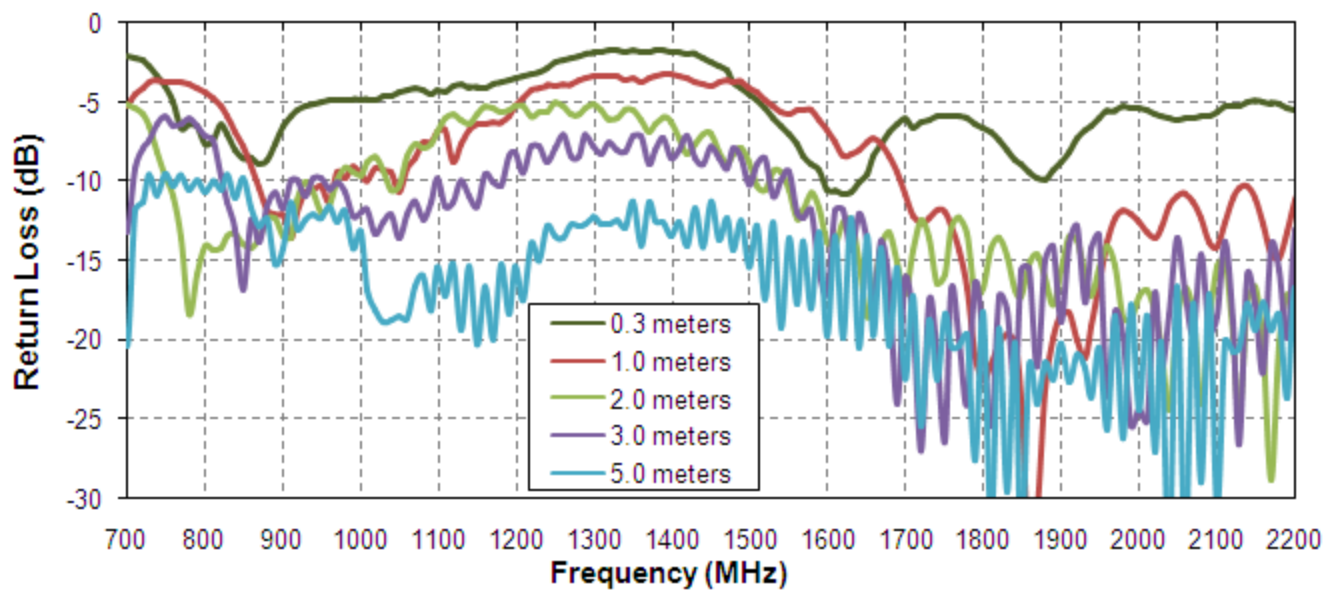

Figure 4. Return Loss of the MA104 antenna on 60*60cm metal plate

4.2 Efficiency

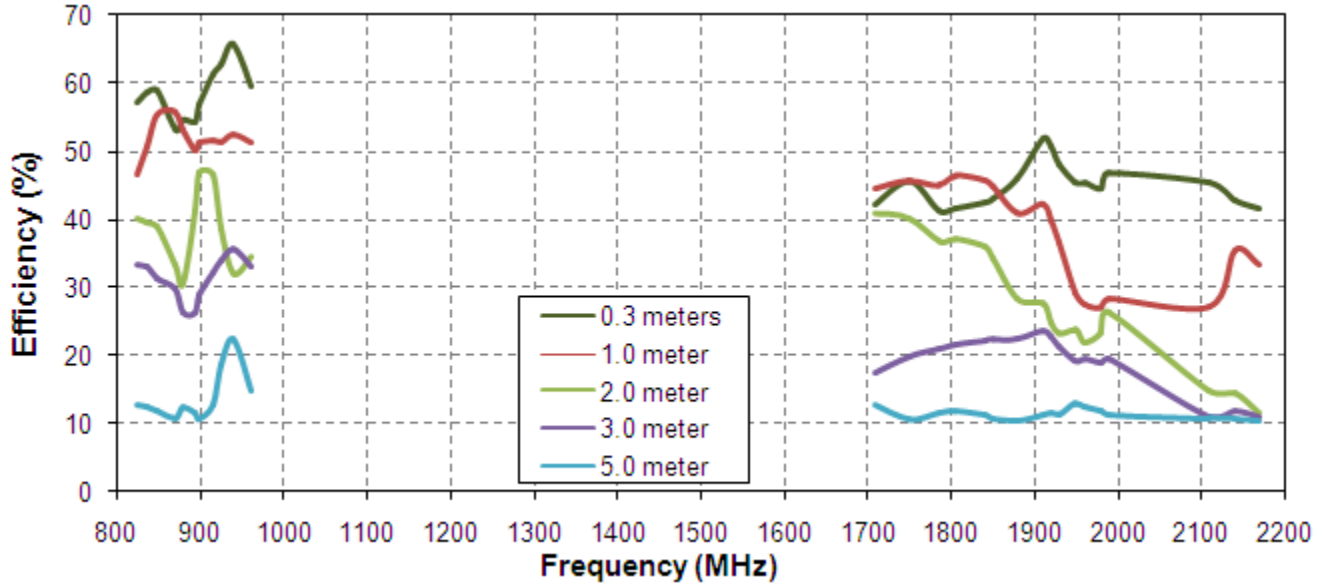

Figure 5. Efficiency of the MA104 antenna in free space

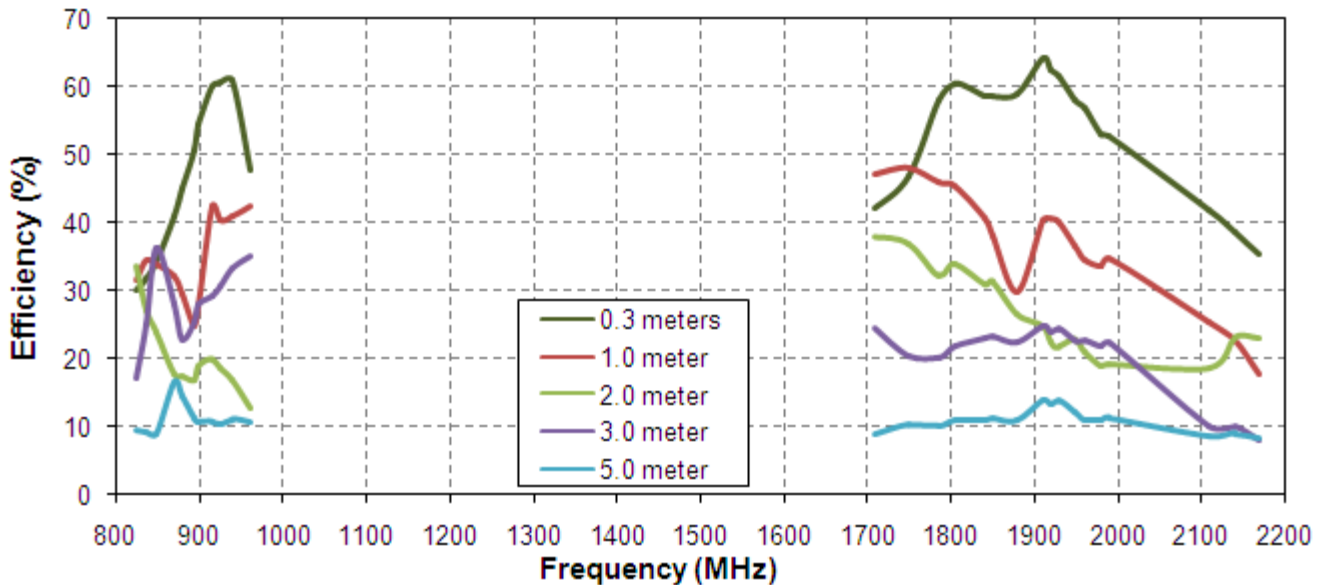

Figure 6. Efficiency of the MA104 antenna on 30*30cm metal plate

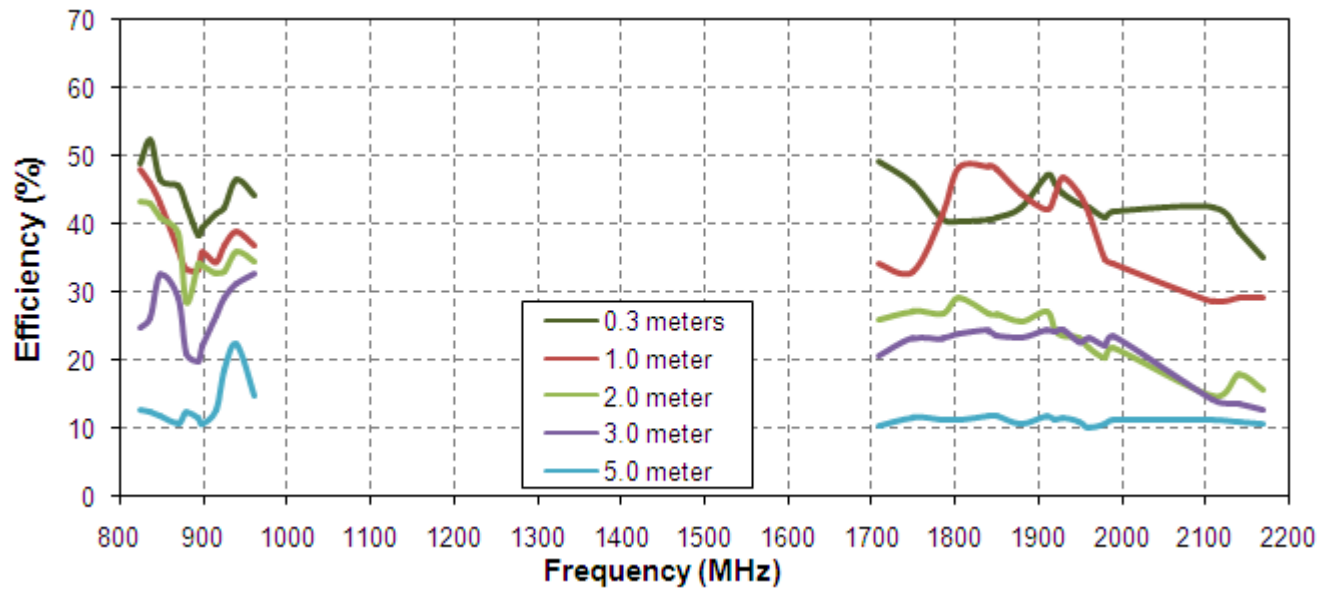

Figure 7. Efficiency of the MA104 antenna on 60*60cm metal plate.

4.3 Peak Gain

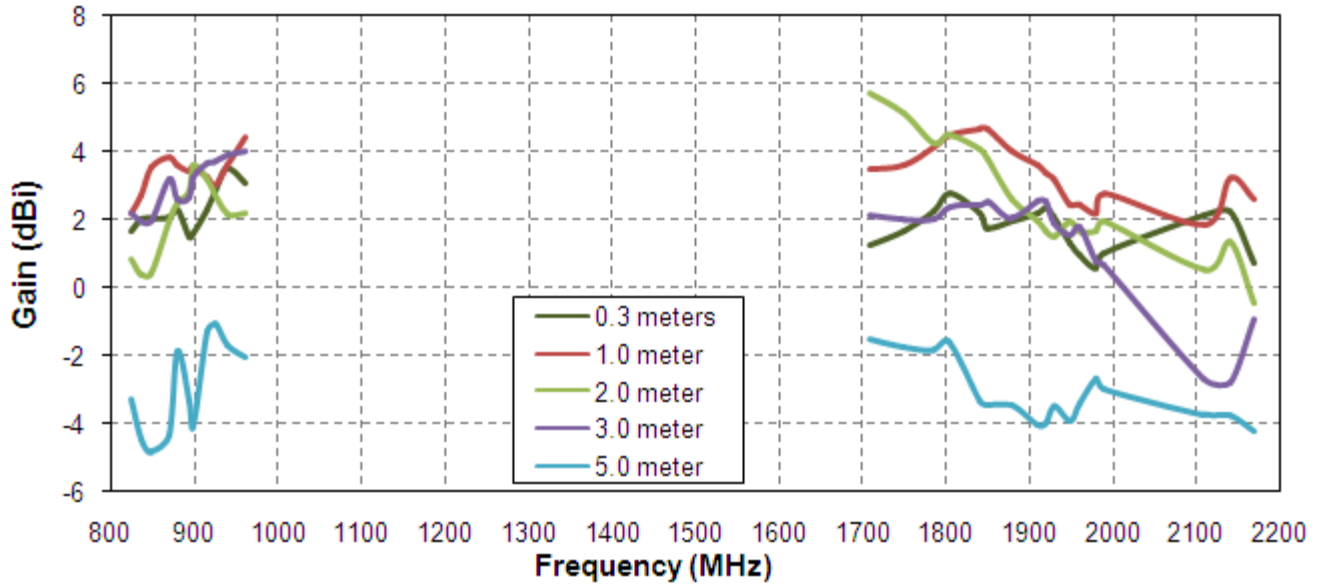

Figure 8. Gain of the MA104 antenna in free space

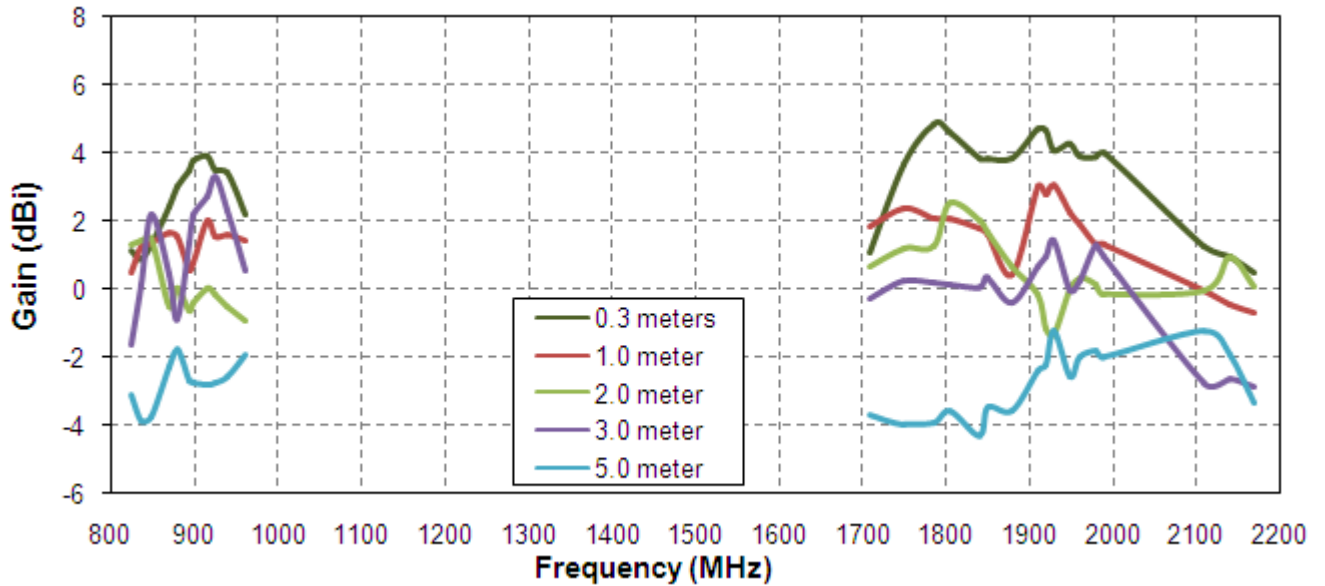

Figure 9. Gain of the MA104 antenna on 30*30cm metal plate

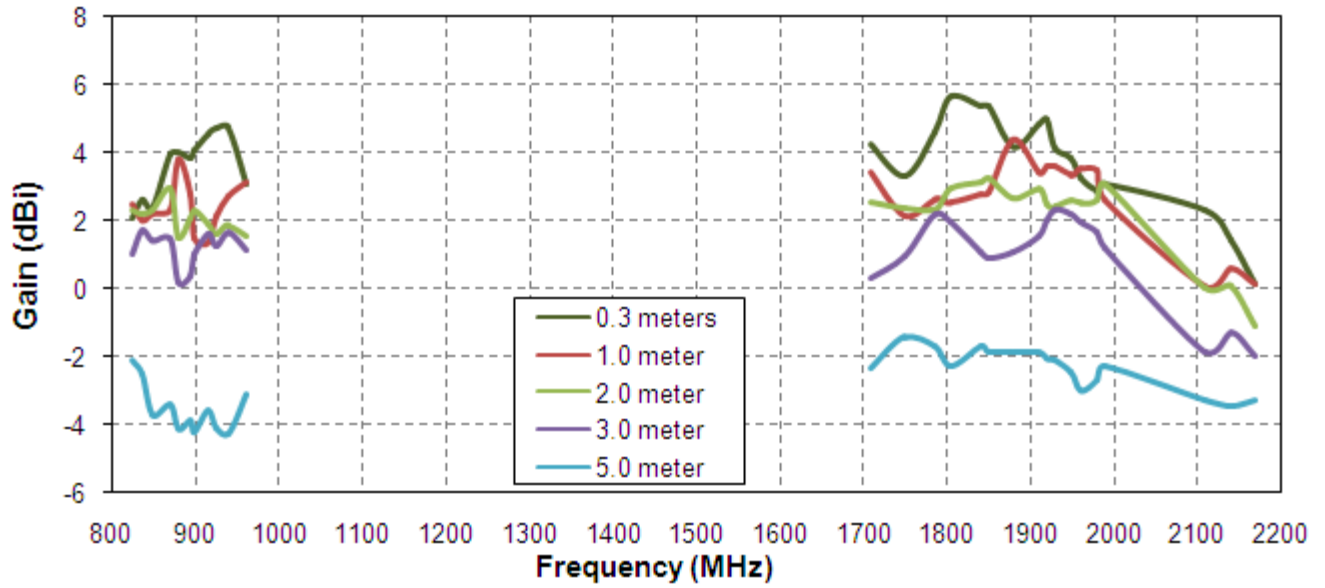

Figure 10. Gain of the MA104 antenna on 60*60cm metal plate

4.4 Radiation pattern

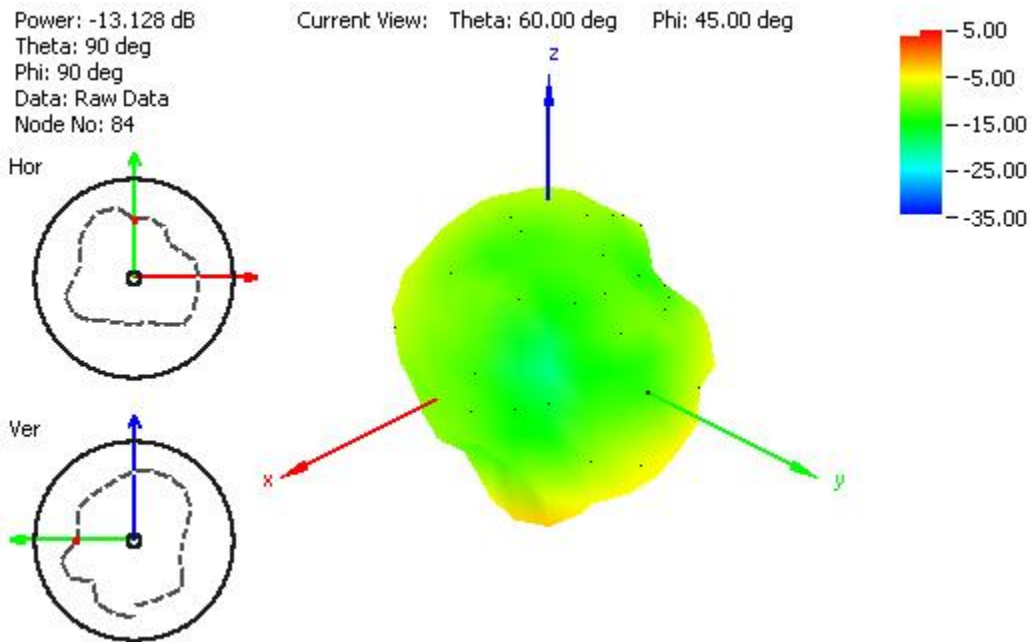

Figure 11. Radiation pattern at 849 MHz, Figure 1 as reference (dB), with 2 m RG174 cable and free space

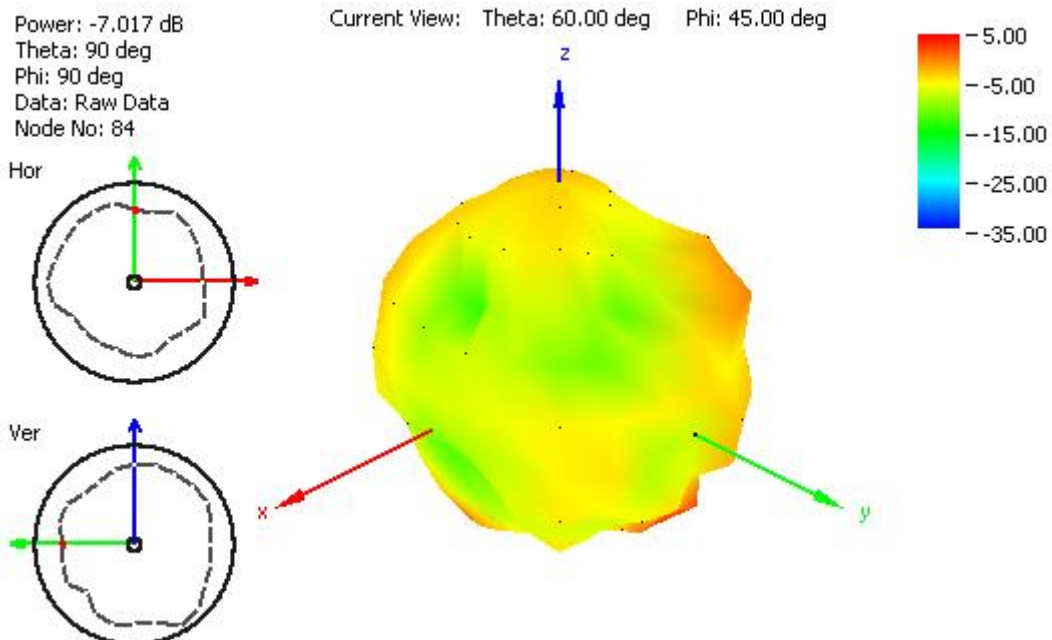

Figure 12. Radiation pattern at 915 MHz, Figure 1 as reference (dB), with 2 m RG174 cable and free space

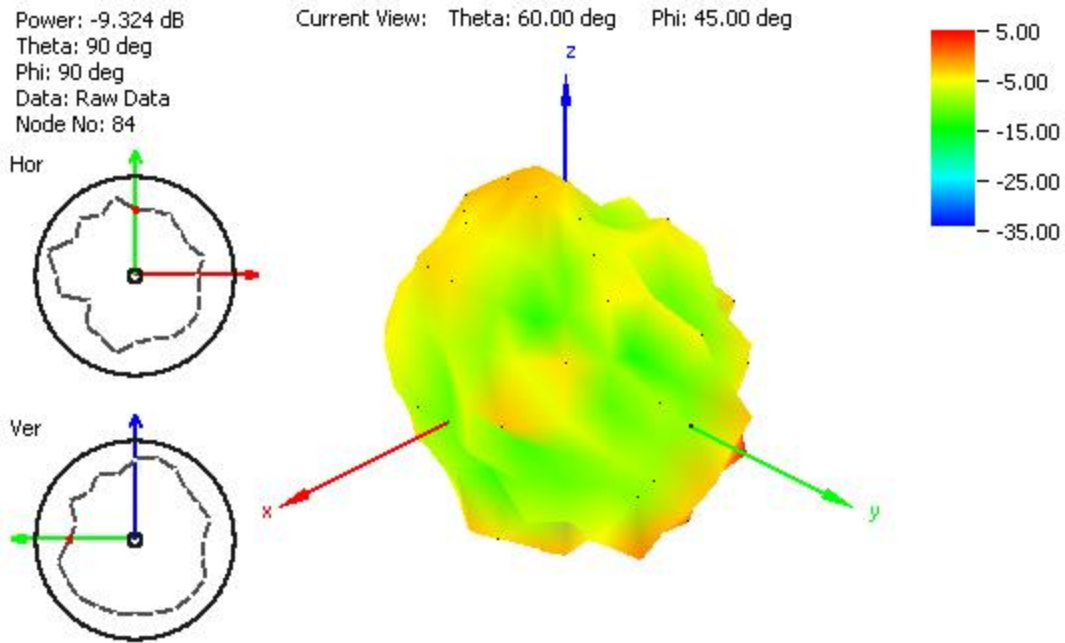

Figure 13. Radiation pattern at 1805 MHz, Figure 1 as reference (dB), with 2 m RG174 cable and free space

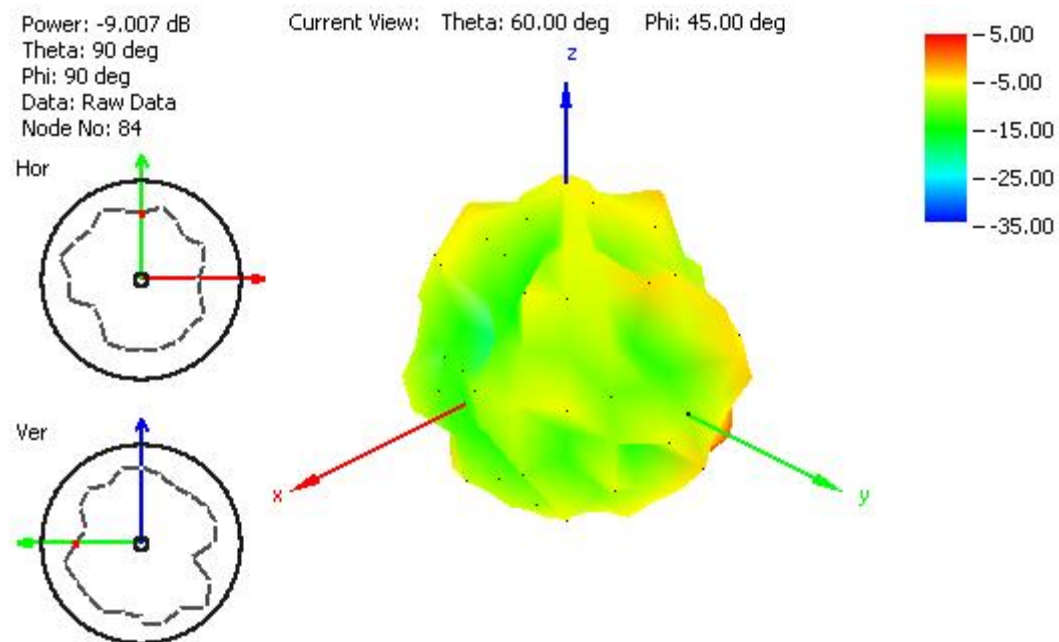

Figure 14. Radiation pattern at 1910 MHz, Figure 1 as reference (dB), with 2 m RG174 cable and free space

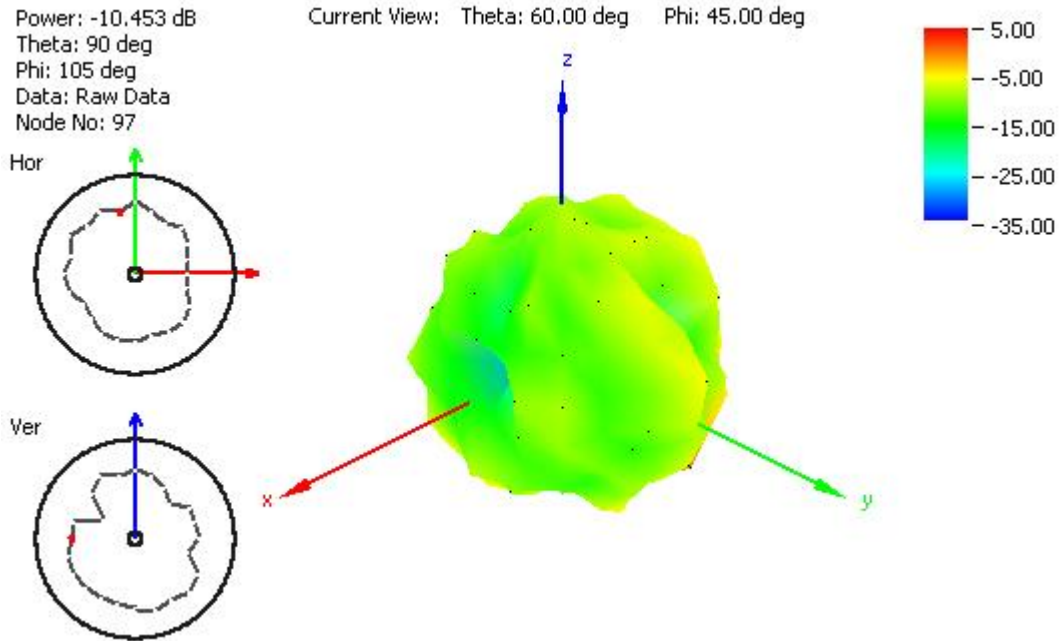

Figure 15. Radiation pattern at 2110 MHz, Figure 1 as reference (dB), with 2 m RG174 cable and free space.

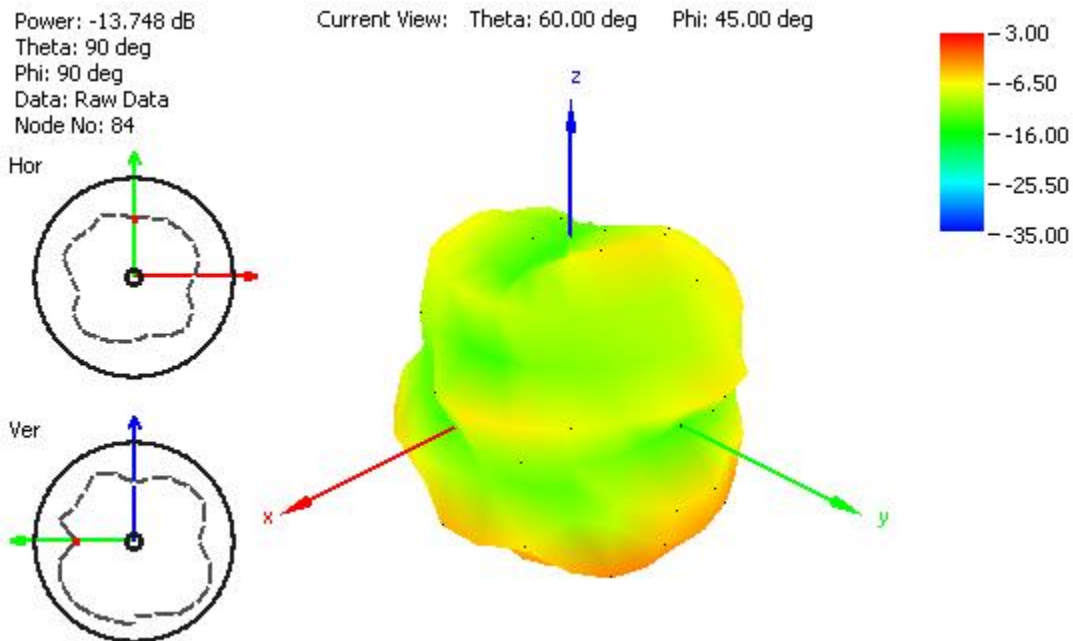

Figure 16. Radiation pattern at 849 MHz, Figure 1 as reference (dB), with 2 m RG174 cable and 30x30 cm metal plate

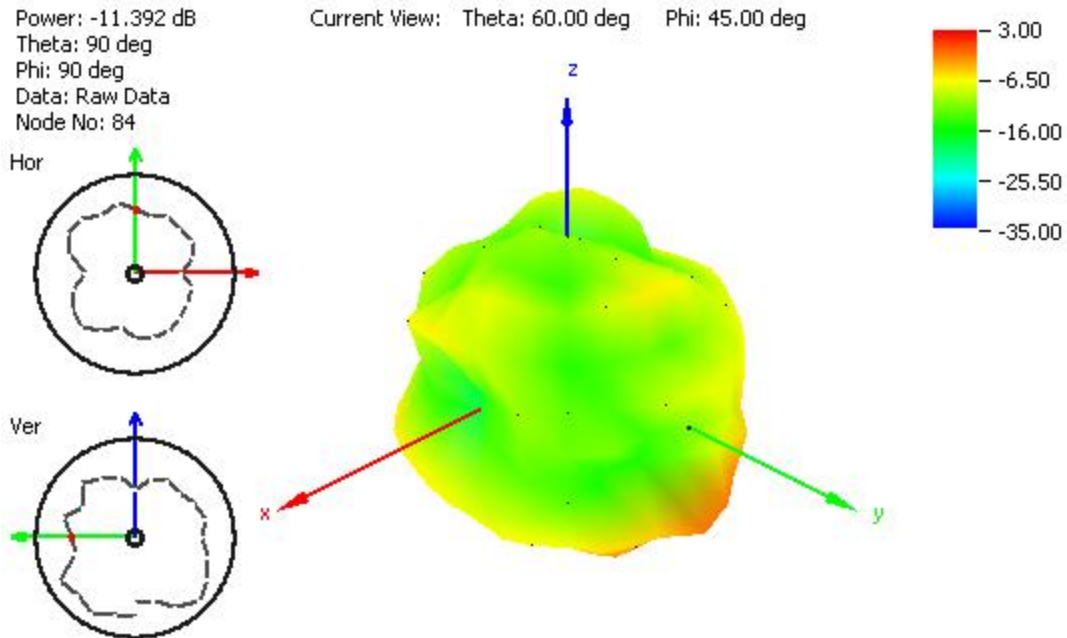

Figure 17. Radiation pattern at 915 MHz, Figure 1 as reference (dB), with 2 m RG174 cable and 30x30 cm metal plate

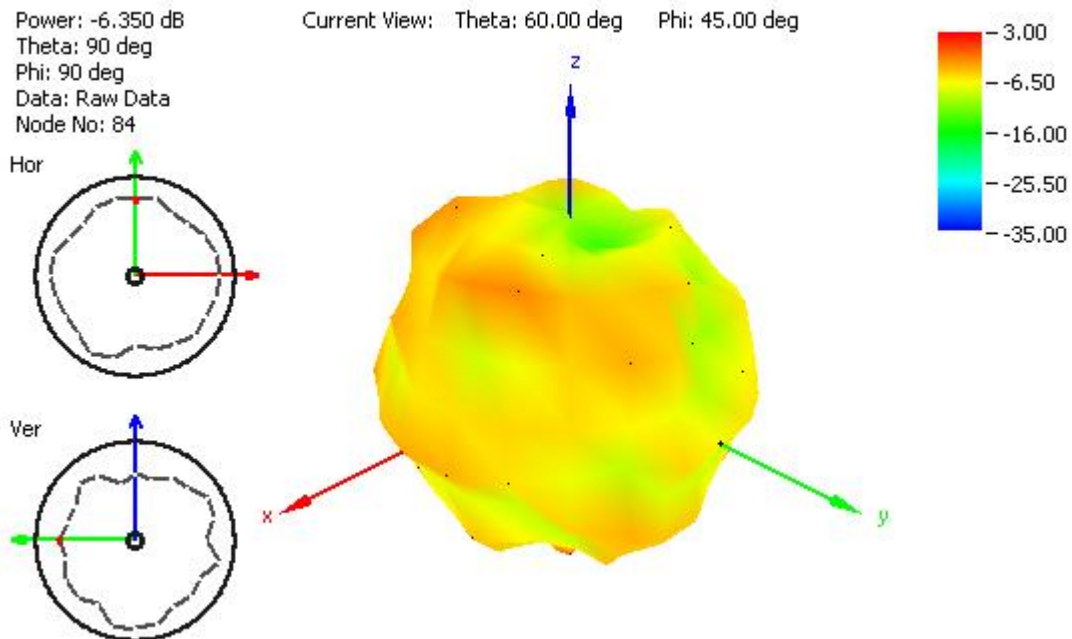

Figure 18. Radiation pattern at 1805 MHz, Figure 1 as reference (dB), with 2 m RG174 cable and 30x30 cm metal plate

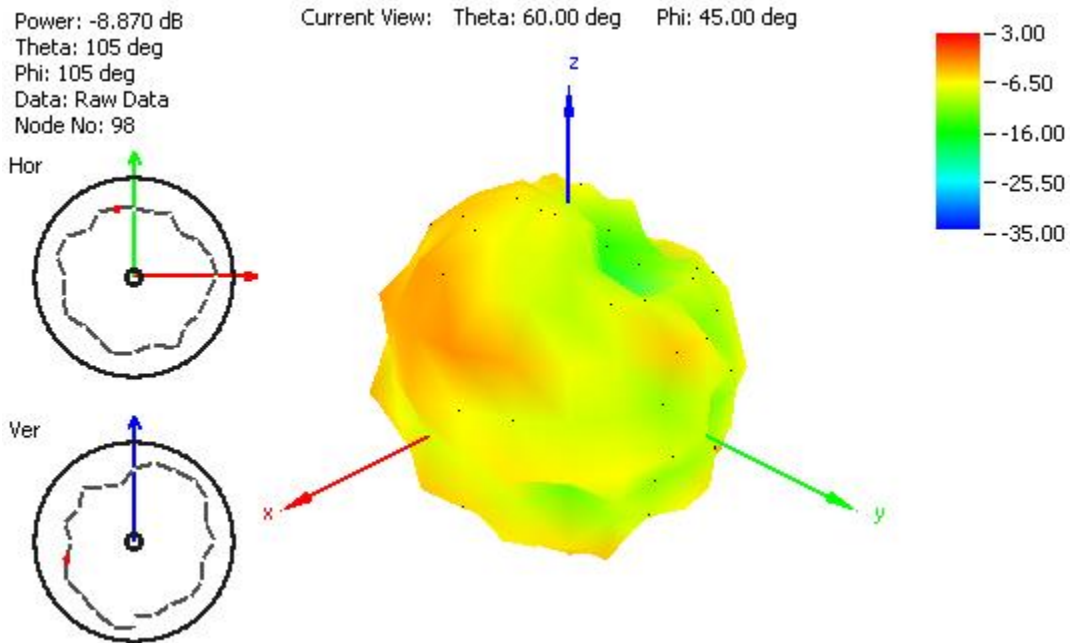

Figure 19. Radiation pattern at 1910 MHz, Figure 1 as reference (dB), with 2 m RG174 cable and 30x30 cm metal plate

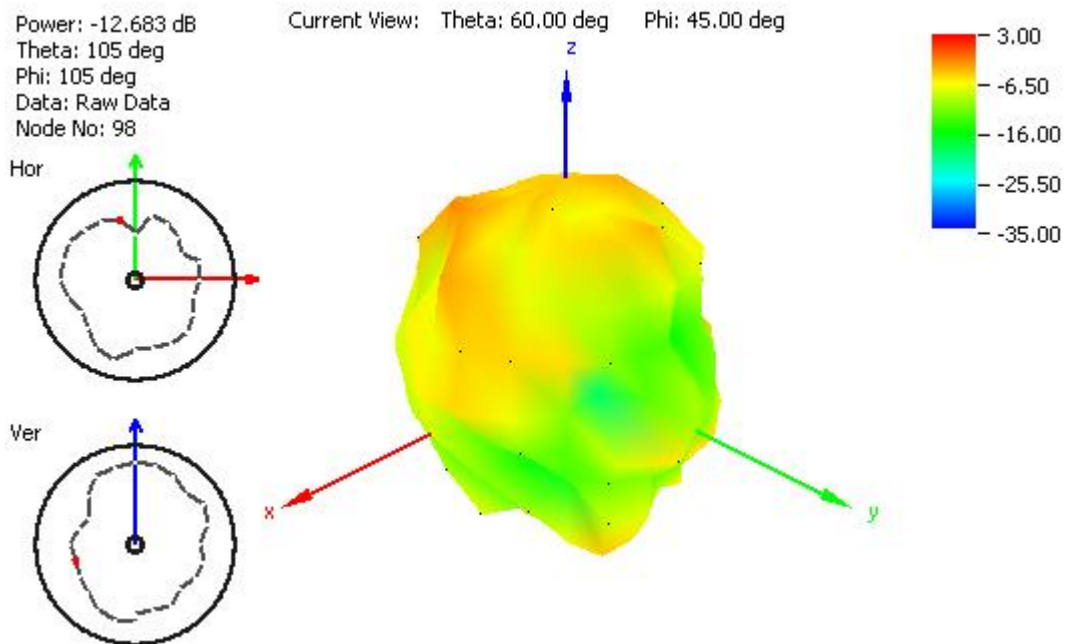

Figure 20. Radiation pattern at 2110 MHz, Figure 1 as reference (dB), with 2 m RG174 cable and 30x30 cm metal plate

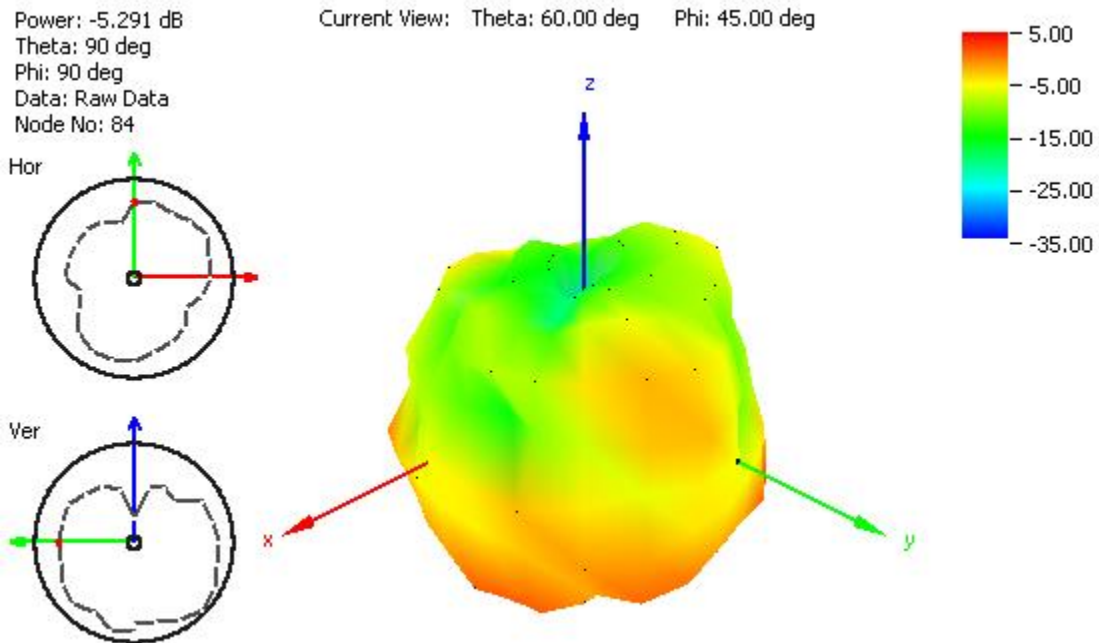

Figure 21. Radiation pattern at 849 MHz, Figure 1 as reference (dB), with 2 m RG174 cable and 60x60 cm metal plate

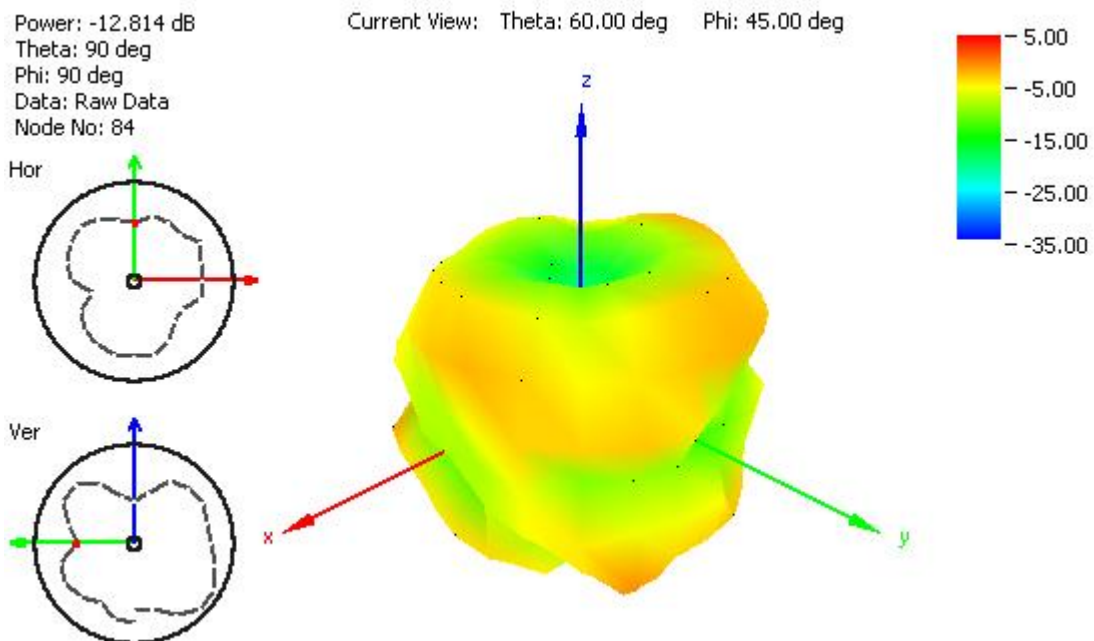

Figure 22. Radiation pattern at 915 MHz, Figure 1 as reference (dB), with 2 m RG174 cable and 60x60 cm metal plate

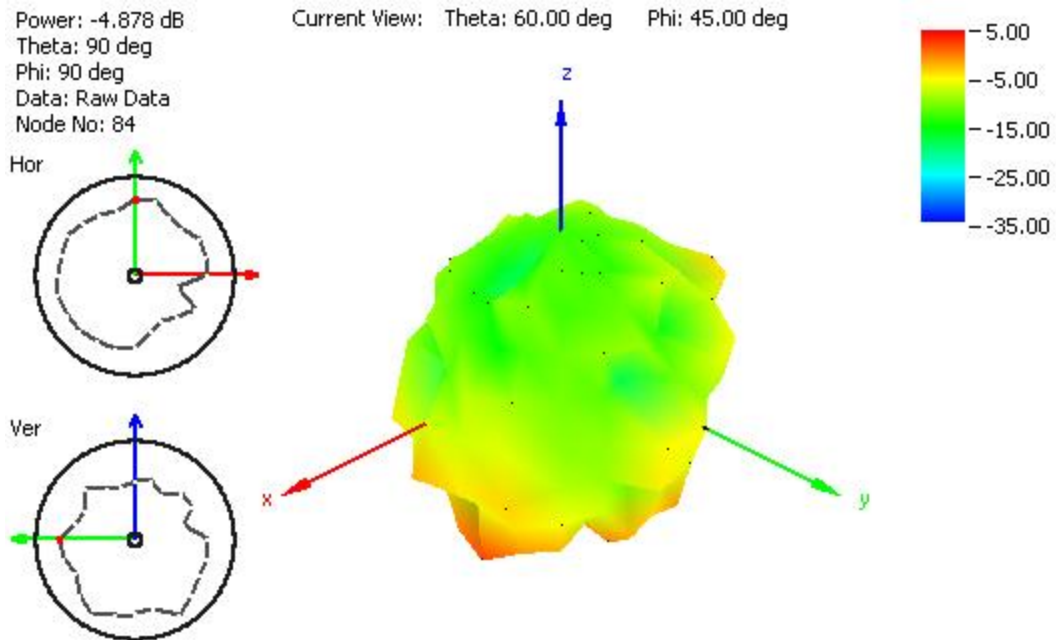

Figure 23. Radiation pattern at 1805 MHz, Figure 1 as reference (dB), with 2 m RG174 cable and 60x60 cm metal plate

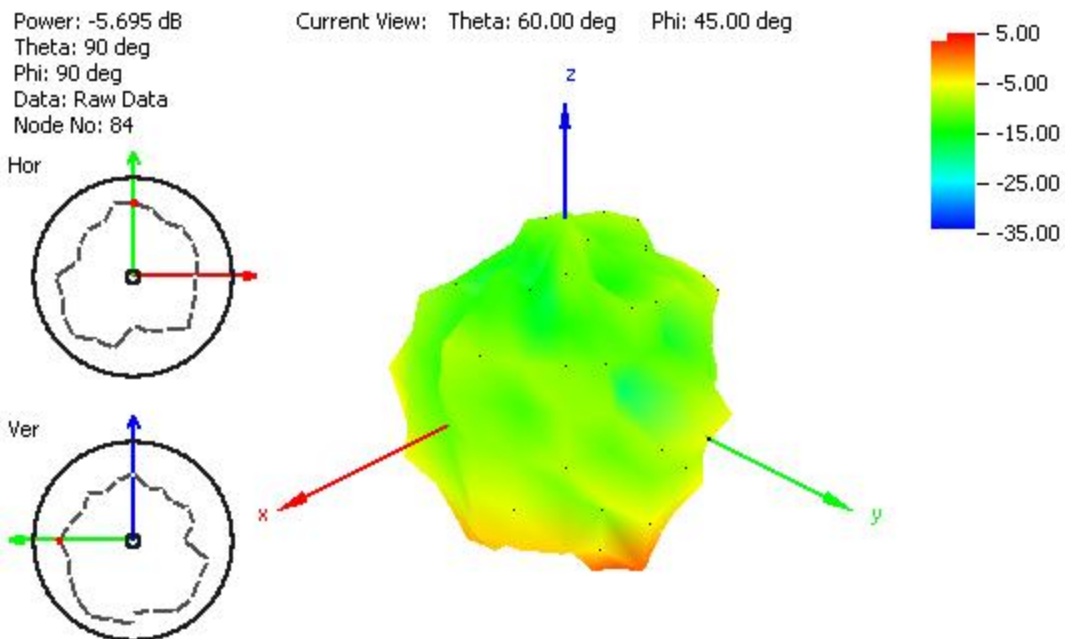

Figure 24. Radiation pattern at 1910 MHz, Figure 1 as reference (dB), with 2 m RG174 cable and 60x60 cm metal plate

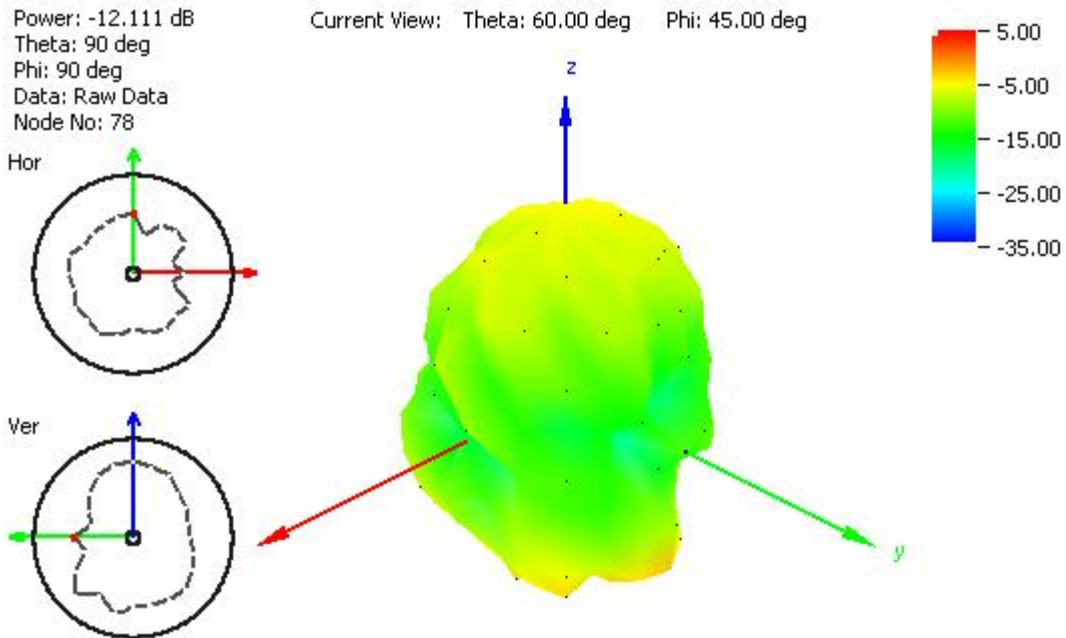
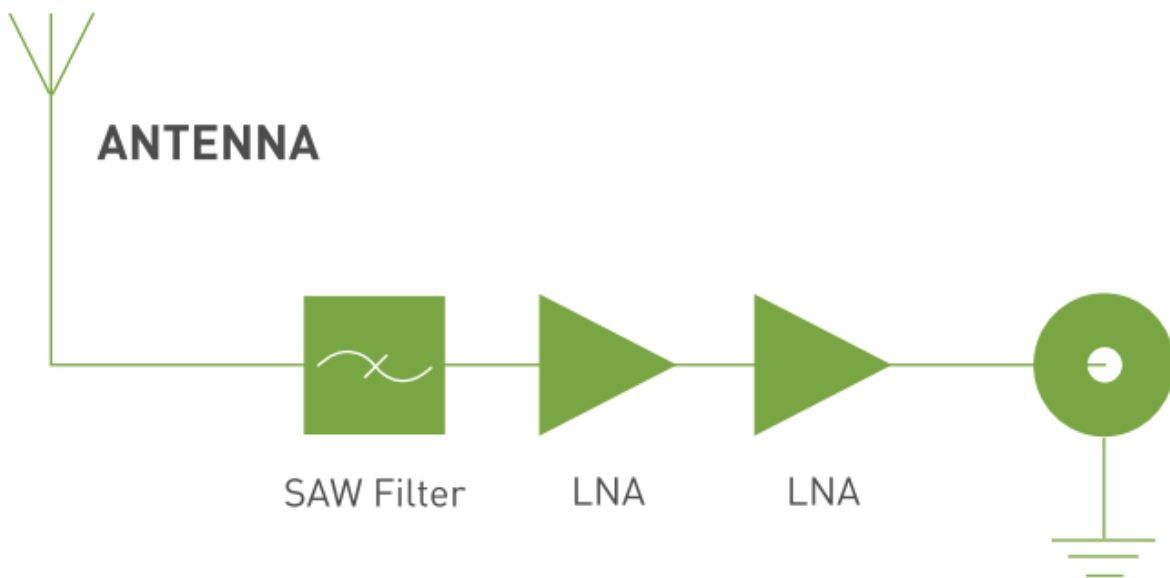

Figure 25. Radiation pattern at 2110 MHz, Figure 1 as reference (dB), with 2 m RG174 cable and 60x60 cm metal plate

5. System Block Diagram





6. GPS/GALILEO Patch Radiation Pattern

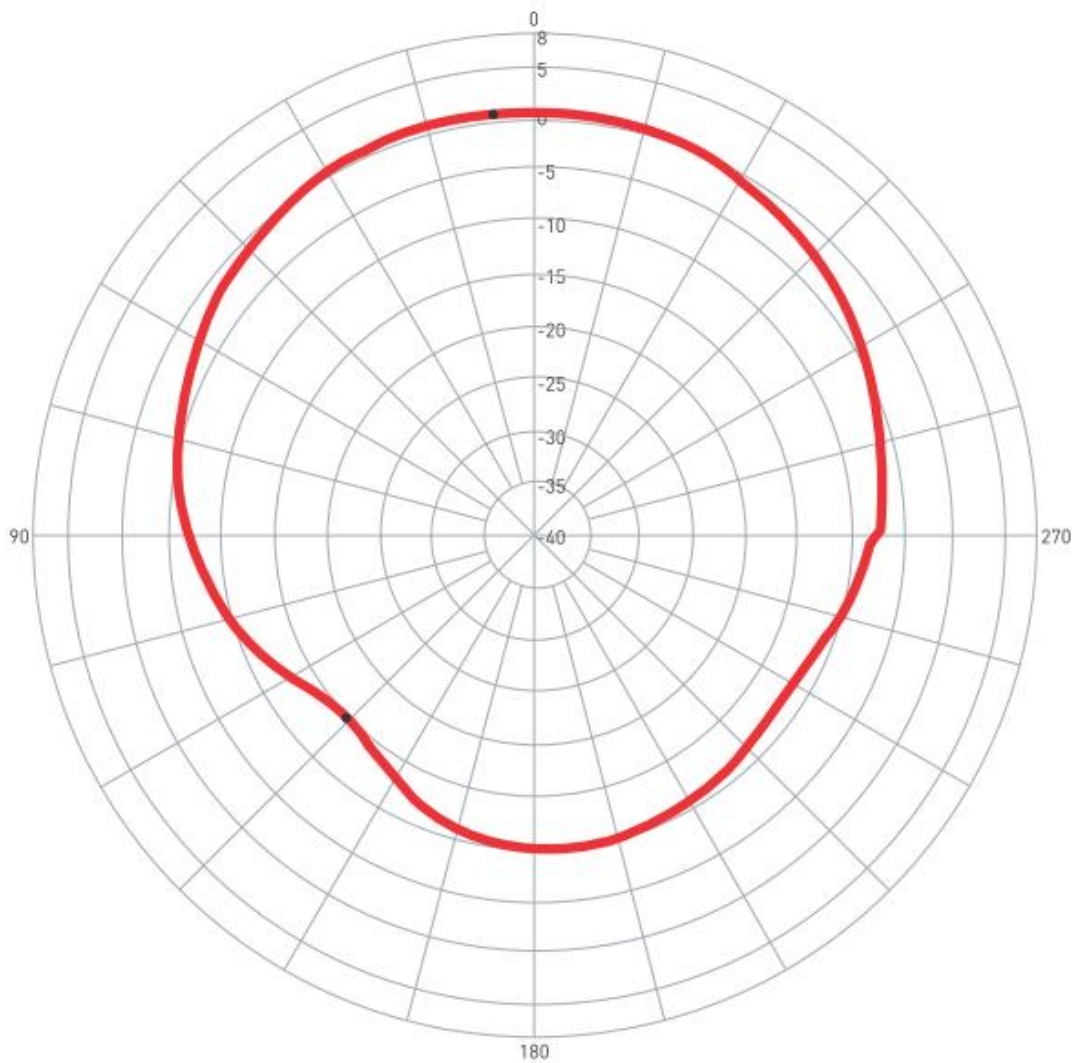

0 degree is the top of Hercules.

7. LNA Properties

7.1 LNA Gain and Out-band Rejection @ 3.0V

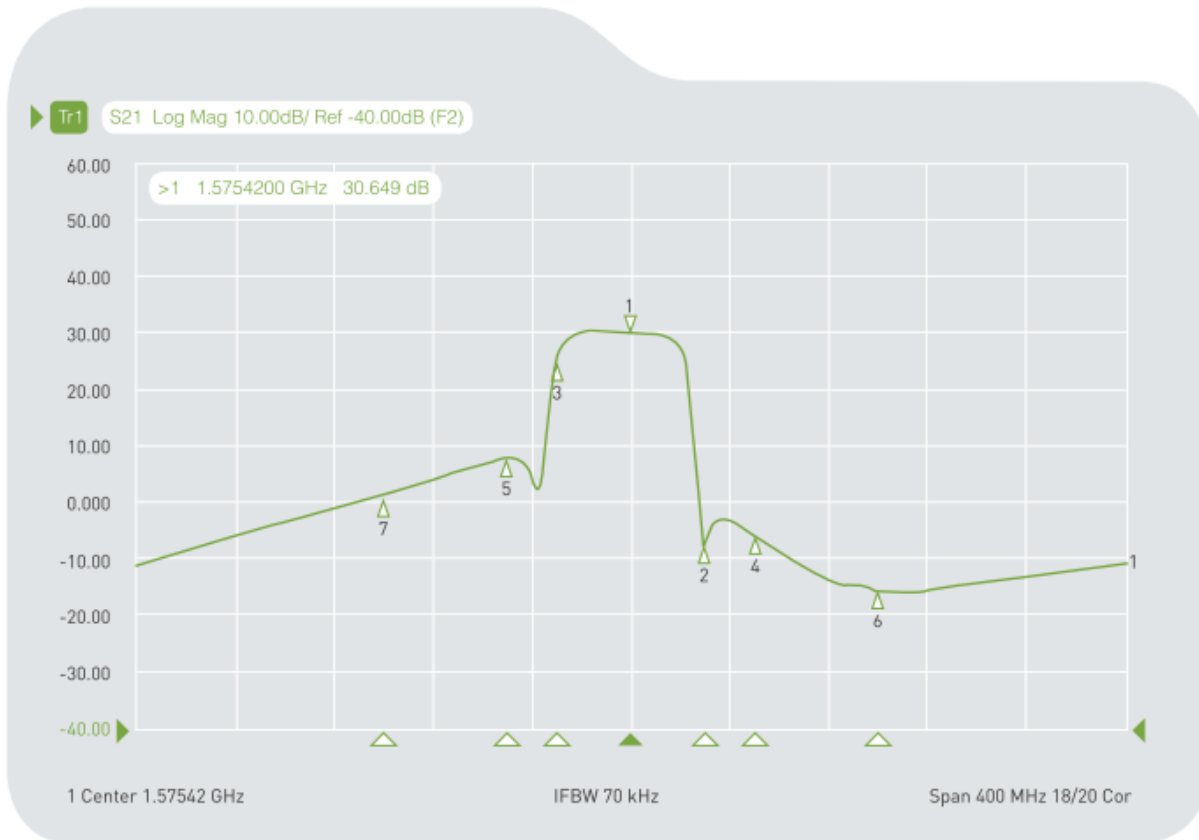

Cg1	Tr1	S21	>1	1.5754200 GHz	30.649	dB
Cg1	Tr1	S21	2	1.6054200 GHz	-6.7098	dB
Cg1	Tr1	S21	3	1.5454200 GHz	24.584	dB
Cg1	Tr1	S21	4	1.6254200 GHz	-5.6354	dB
Cg1	Tr1	S21	5	1.5254200 GHz	8.0734	dB
Cg1	Tr1	S21	6	1.6754200 GHz	-15.436	dB
Cg1	Tr1	S21	7	1.4754200 GHz	-1.5714	dB

7.2 Noise Figure

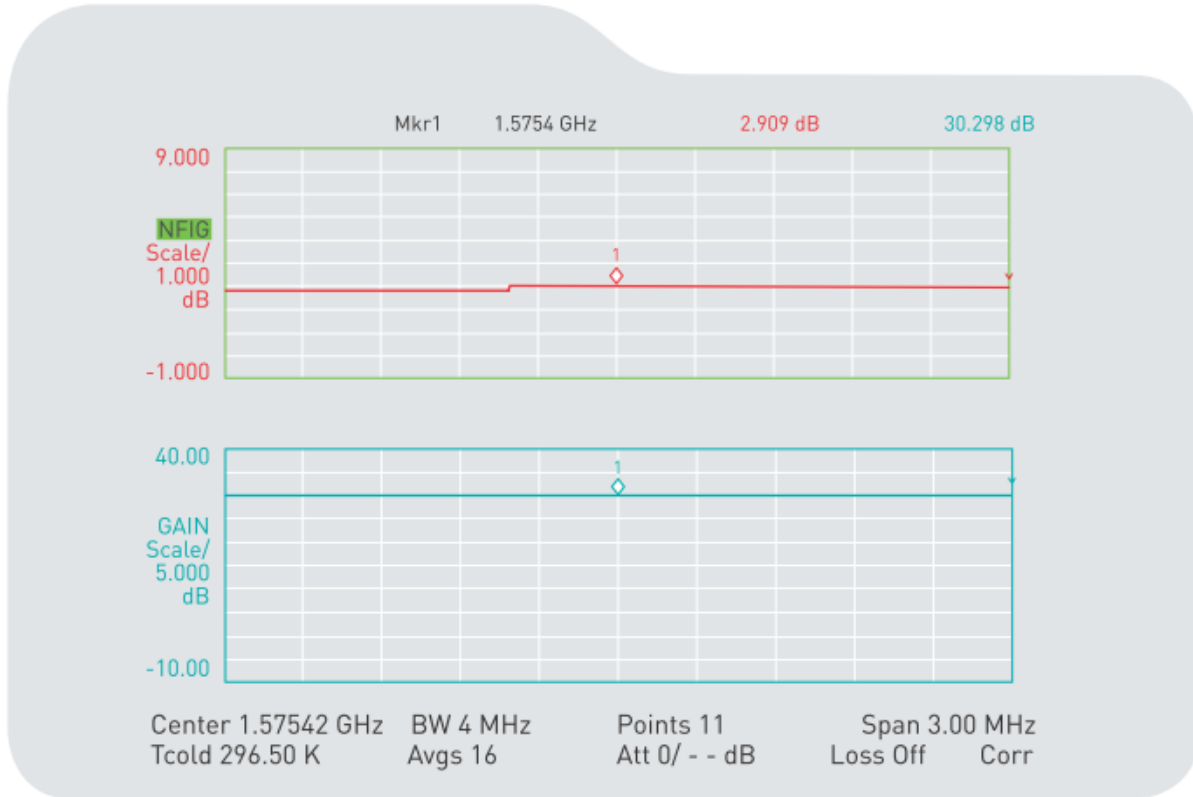



TAOGLAS

8. Drawing (Unit : mm)

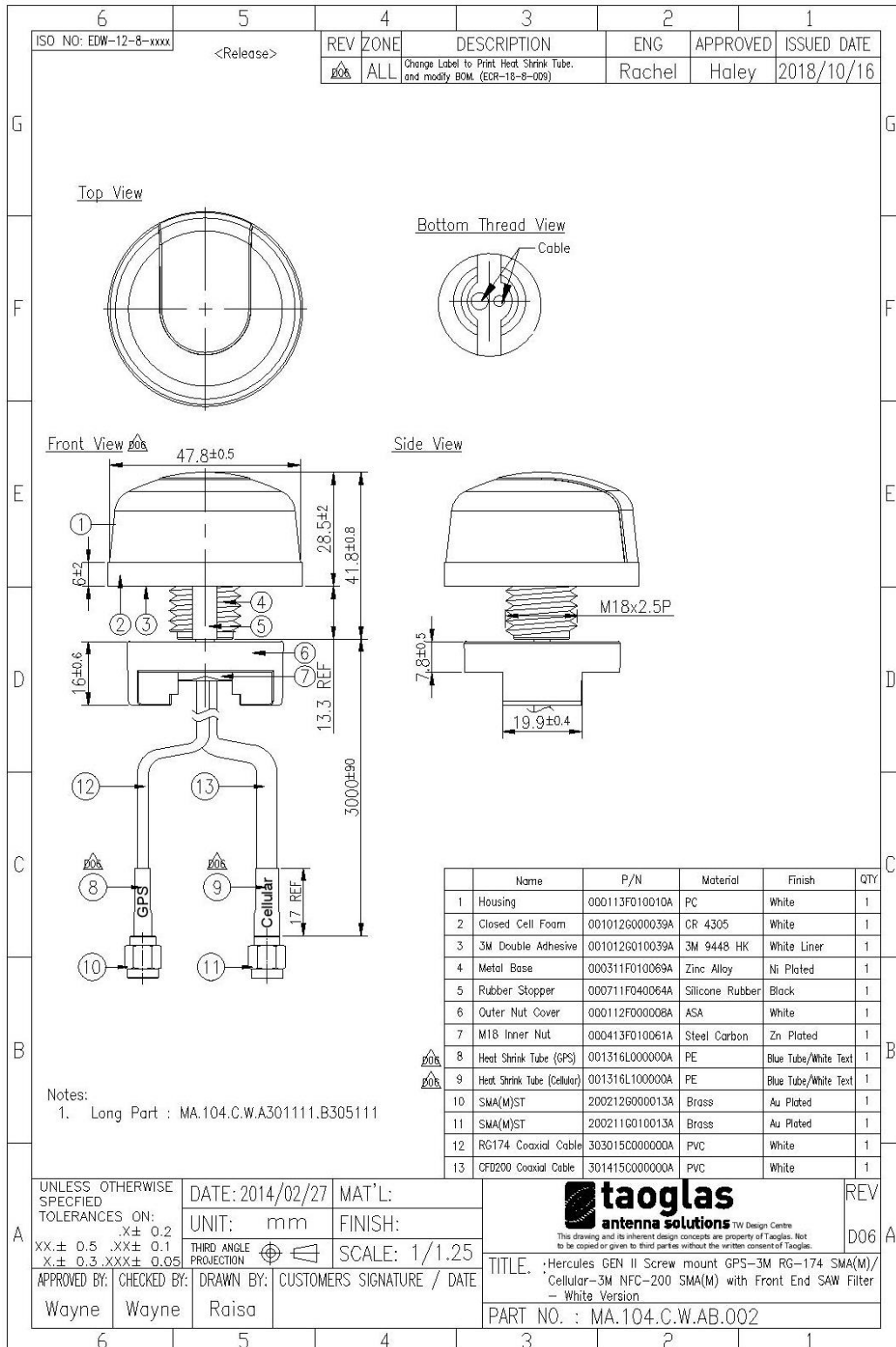

9. Installation

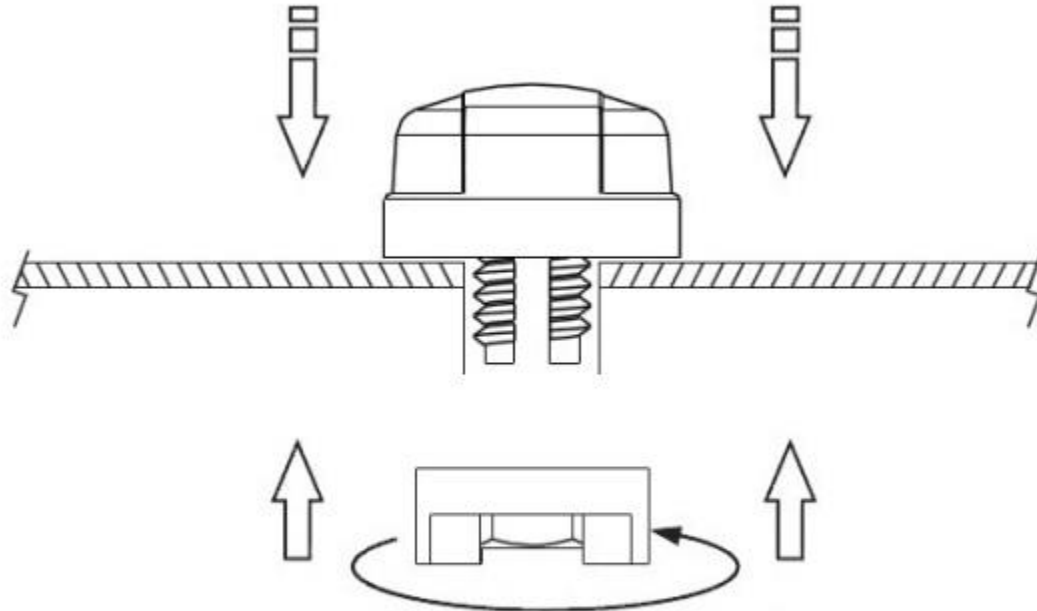

Recommended torque for Mounting is 24.5N·m
Maximum torque for mounting is 29.4N·m





10. Packaging

1pcs antenna per big PE bag
40 big PE bags per box

Unit : mm

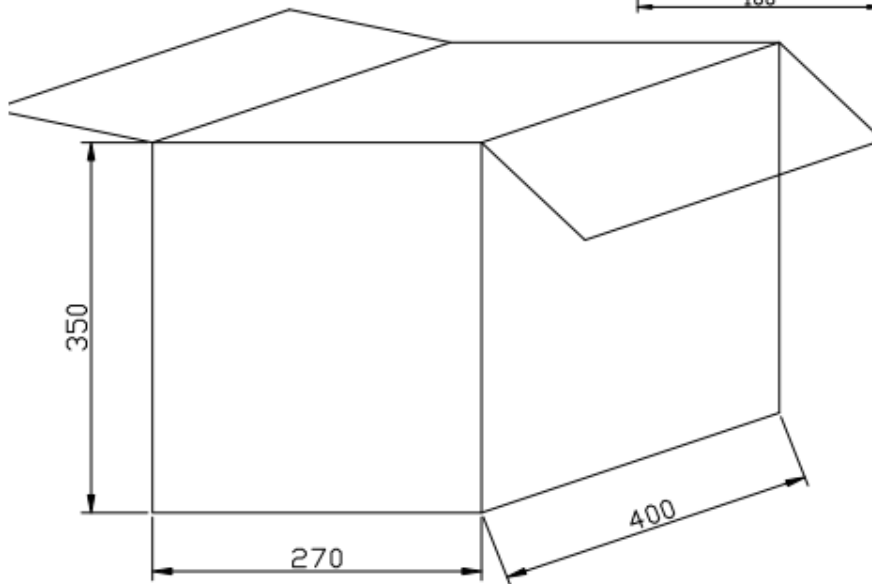
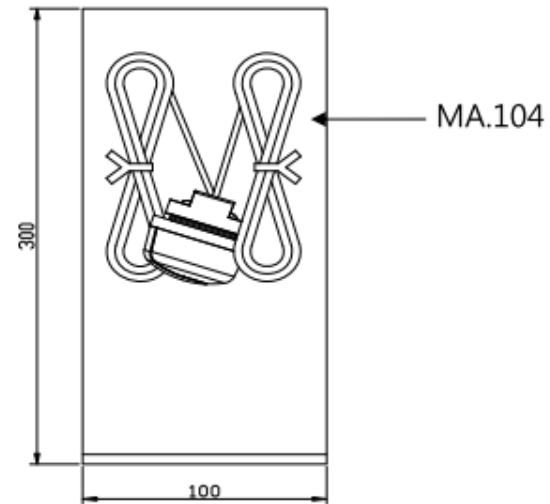

Taoglas makes no warranties based on the accuracy or completeness of the contents of this document and reserves the right to make changes to specifications and product descriptions at any time without notice. Taoglas reserves all rights to this document and the information contained herein.

Reproduction, use or disclosure to third parties without express permission is strictly prohibited.

© Taoglas