

Type 5ET / 5ETP

Time-lag Fuse Series (High Surge-proof, Enhanced-Breaking Capacity)

HF  5ET/5ETP Series, 5x20mm Glass Tube Time-lag Fuse

RoHS Compliant

Description

5x20mm Time-lag fuse, high surge-proof, enhanced breaking capacity, glass tube body cartridge fuse designed, approved and complied with IEC 60127-2, standard sheet 6.



Features

- Meet IEC standard 60127-2, sheet 6
- Wide operating temperature range
- Bulk and Tape & Reel packing available
- Full compliance with EU Directive 2011/65/EU and amending directive 2015/863
- Halogen Free
- Lead Free

Applications



Provide individual protection for components or internal circuits.

- Power supplies
- Battery charger
- Monitor
- Adapter

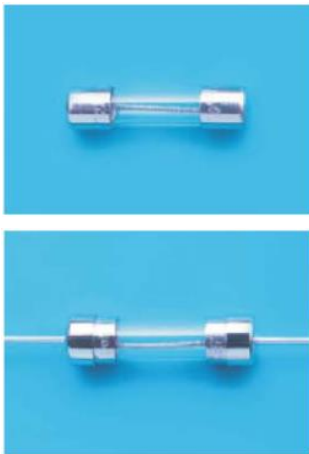
LEAD FREE = 
HALOGEN FREE = 



Physical Specifications





Materials	Body : Glass
	Cap : Nickel Plated Brass Caps
	Leads : Matte Tin Plated Copper
Marking	On Fuse :
	"bel", "T", "Current Rating", "E", "250V",
	"Appropriate Safety Logos", "✓" (RoHS compliant)
	On Label :
	"bel", "5ET" or "5ETP", "T", "Current Rating", "E", "Voltage Rating", "Interrupting Rating", "Appropriate Safety Logos" and "✓", "  ", "  "(China RoHS compliant).

Electrical Characteristics (IEC-127-2 STANDARD SHEET 6)

Rated Current	1.5 In		2.1 In		2.75 In		4 In		10 In	
	MIN	MAX	MIN	MAX	MIN	MAX	MIN	MAX	MIN	MAX
1A to 12A	1 hr.	2 min.	600 ms	10 sec	150 ms	3 sec	20 ms	300 ms		

In clause 9.2, the test voltage for 5ETP ratings from 1A to 6.3A is 63VDC.





Safety Agency Approvals

Safety Agency	Safety Agency Certificate	Ampere Rating/ Voltage Rating	Ampere Range / Volt @ I.R. ability*
	1720086 1907484 1907485	1A-12A /250V AC	1A-6.3A/250V AC@150A 8A-10A/250V AC@150A 12A/250V AC@150A
			40007746
	E20624		
	LR39772		
	Self-declaration No: 2020970207000296		1A-10A/250V AC@150A
*I.R.= Interrupting Rating = Short Circuit Rating(Amps)			

Environmental Specifications

Shock Resistance	MIL-STD-202G, Method 213B, Test Condition 1 (100 G's peak for 6 milliseconds; Sawtooth waveform)
Vibration Resistance	MIL-STD-202G, Method 201A (10-55 Hz, 0.06 inch, total excursion).
Salt Spray Resistance	MIL-STD-202G, Method 101E, Test Condition B (48 hrs).
Insulation Resistance	MIL-STD-202G, Method 302, Test Condition B (After Opening) 100,000 ohms minimum.
Solderability	MIL-STD-202G, Method 208H
Resistance to solder Heat	MIL-STD-202G, Method 210F, Test Condition B. (260+/-5°C, 10+/-1 sec)
Thermal Shock	MIL-STD-202G, Method 107G, Test Condition B (-65°C to +125°C).
Operating Temperature	-55°C to +125°C
Terminal Strength	IEC-68-2-21

Electrical Specifications

Catalog Number	Ampere Rating	Typical Cold Resistance (ohms)	Volt-drop @100%In (Volt) max.	Voltage and Interrupting Ratings	Melting I ² T <10 mSec (A ² Sec)	Melting I ² T @10 In (A ² Sec)	Maximum Power Dissipation (W)	Agency Approvals				
												
5ET(P) 1-R	1A	0.111	0.15	See Table of Safety Approvals on Page 1 for Voltage and associated Interrupting Ratings	28	29	0.42	Y	Y	Y	Y	Y
5ET(P) 1.25-R	1.25A	0.073	0.13		42	43	0.42	Y	Y	Y	Y	Y
5ET(P) 1.6-R	1.6A	0.058	0.13		62	64	0.51	Y	Y	Y	Y	Y
5ET(P) 2-R	2A	0.039	0.12		92	95	0.61	Y	Y	Y	Y	Y
5ET(P) 2.5-R	2.5A	0.031	0.12		137	142	0.74	Y	Y	Y	Y	Y
5ET(P) 3.15-R	3.15A	0.023	0.10		203	211	0.90	Y	Y	Y	Y	Y
5ET(P) 4-R	4A	0.017	0.10		300	313	1.08	Y	Y	Y	Y	Y
5ET(P) 5-R	5A	0.012	0.09		444	465	1.31	Y	Y	Y	Y	Y
5ET(P) 6.3-R	6.3A	0.010	0.09		658	691	1.58	Y	Y	Y	Y	Y
5ET(P) 8-R	8A	0.007	0.09		252	277	3.11			Y	Y	
5ET(P) 10-R	10A	0.006	0.08		400	440	3.68			Y	Y	
5ET(P) 12-R	12A	0.005	0.08		635	699	4.36				Y	

Consult manufacturer for other ratings



Specifications subject to change without notice

Bel Fuse Inc.
206 Van Vorst Street
Jersey City, NJ 07302 USA

+1 201.432.0463
Bel.US.CS@belf.com
belfuse.com/circuit-protection

Temperature Derating Curve

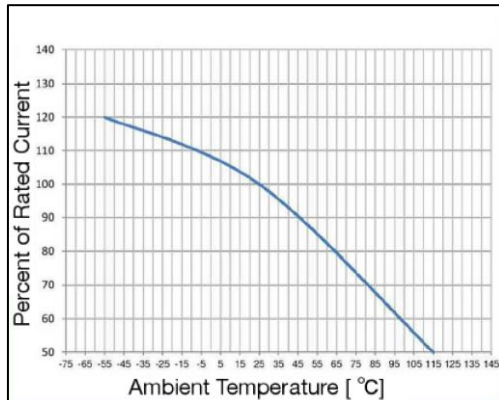

Average Time Current Curve

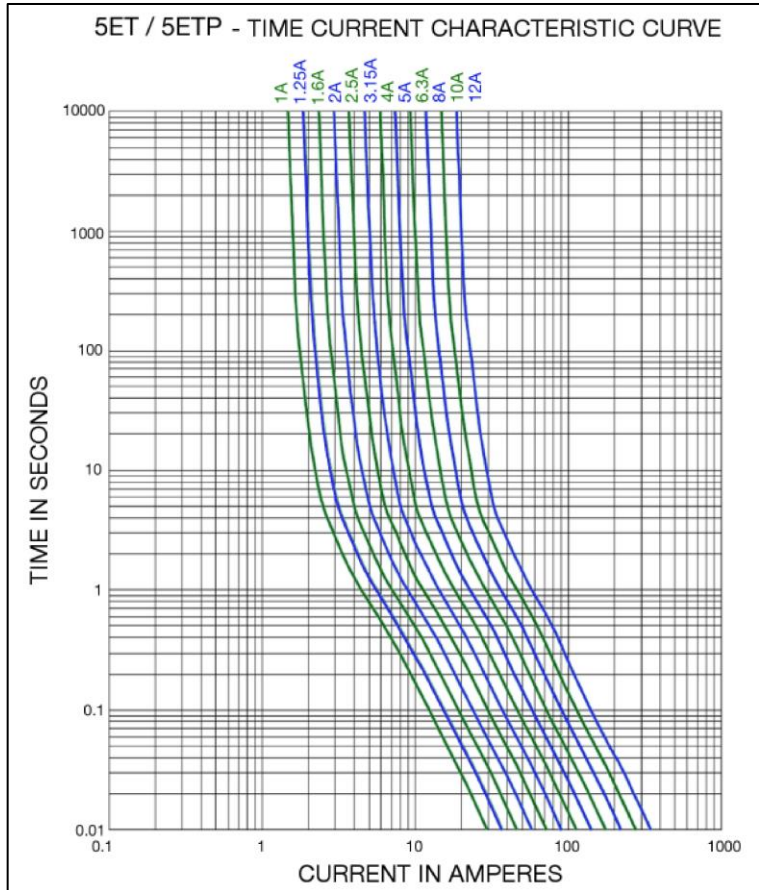

Soldering Parameters

Lead-free Wave Soldering Profile	
Wave Soldering Parameter	
Average ramp-up rate	200°C / second
Heating rate during preheat	typical 1 - 2°C / second Max 4°C / second
Final preheat temperature	within 125°C of soldering temperature
Peak temperature T_p	260°C
Time within +0°C / -5°C of actual peak temperature	10 seconds
Ramp-down rate	5°C / second max.

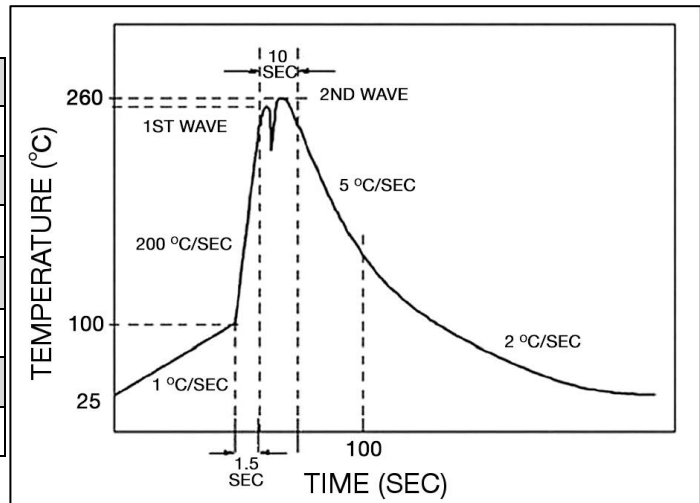

Type 5ET / 5ETP

Fuse FGNO Explanation

0655 R [XXXX] -XX

0655R=5ET/5ETP; [XXXX]=Ampere Rating; XX=See Ordering Information as below

Fraction	Decimal	Amps	Bel FGNO[XXXX]
	1.0	1	1000
1-1/4	1.25	1.25	1250
	1.60	1.6	1600
	2.0	2	2000
2-1/2	2.5	2.5	2500
	3.15	3.15	3150
	4.0	4	4000
	5.0	5	5000
	6.3	6.3	6300
	8.0	8	8000
		10	9100
		12	9120

Mechanical Dimensions

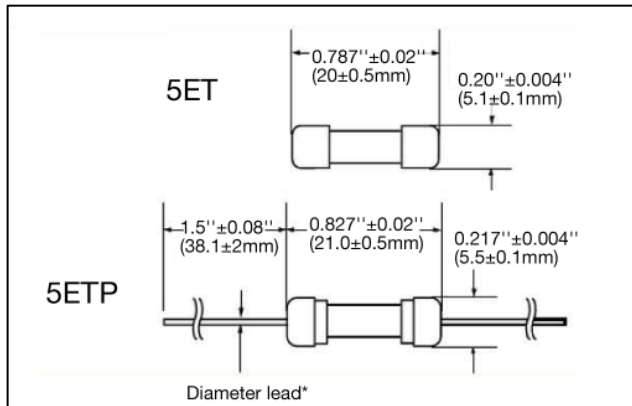

*Ratings 6.3A and less have 0.032"±0.002" diameter lead;
 *Ratings 8A and above have 0.039"±0.002" diameter lead.

Ordering Information

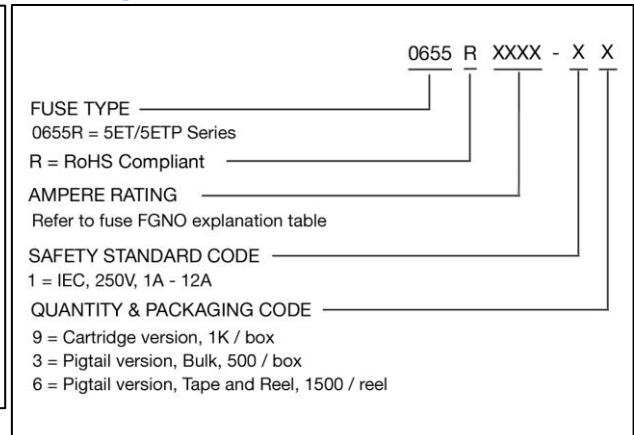

Packaging

Packaging Option	Packaging Specification	Quantity	Packaging Code	Inside Tape Spacing
Bulk	N/A	1000	19	N/A
Bulk (Pigtail Type)	N/A	500	13	N/A
Tape & Reel	EIA-296-F	1500	16	10mm Pitch and 63mm



Specifications subject to change without notice

Bel Fuse Inc.
 206 Van Vorst Street
 Jersey City, NJ 07302 USA

+1 201.432.0463
 Bel.US.CS@belf.com
belfuse.com/circuit-protection