

Data sheet | Item number: 787-1664/004-1000

Electronic circuit breaker; 4-channel; 24 VDC input voltage; 3.8 A; active current limitation; NEC Class 2; communication capability

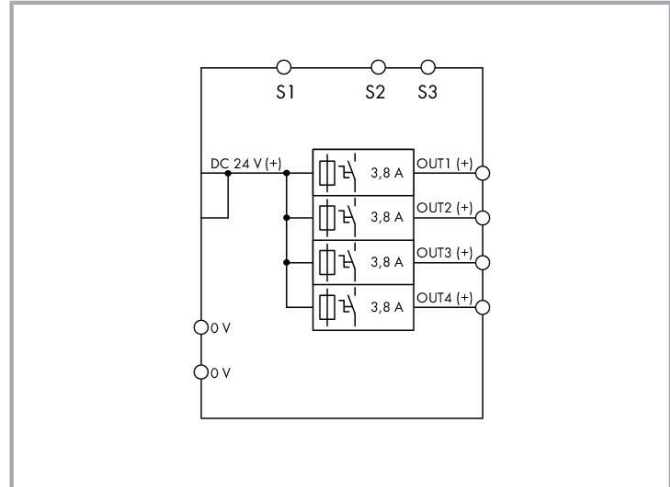

www.wago.com/787-1664/004-1000



i Picture differs from the item.

Similar to illustration

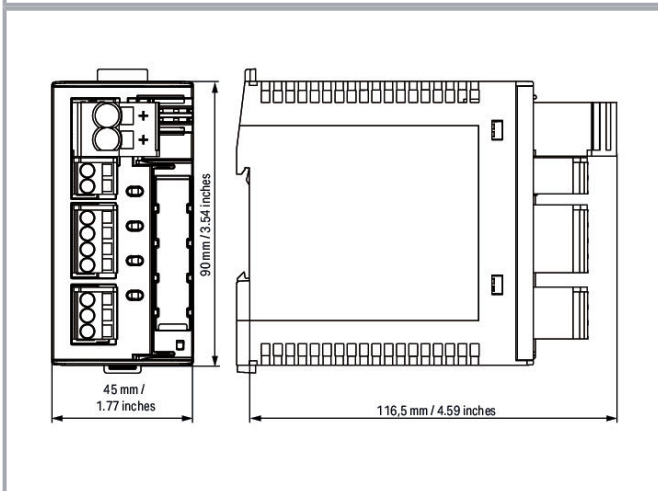

Subject to changes. Please also observe the further product documentation!

WAGO GmbH & Co. KG
Hansastr. 27
32423 Minden
Phone: +49571 887-0 | Fax: +49571 887-169
Email: info.de@wago.com | Web: www.wago.com

Do you have any questions about our products?
We are always happy to take your call at +49 (571) 887-44222.



Item description

Features:

- Space-saving ECB with four channels
- Nominal current is fixed at 3.8 A for each channel
- Each output complies with NEC Class 2
- Active current limitation
- Switch-on capacity > 65000 μ F per channel
- One illuminated, three-colored button per channel simplifies switching (on/off), resetting, and on-site diagnostics
- Time-delayed switching of channels
- Tripped message (group signal)
- Status message for each channel via pulse sequence
- Remote input resets tripped channels or switches on/off any number of channels via pulse sequence

Data

Technical data

Input

Nominal input voltage $U_{i\text{nom}}$	DC 24 V
Input voltage range	DC 20 ... 28.8 V

Output

Total number of channels (module)	4
Nominal output voltage $U_{o\text{nom}}$	4 x DC 24 V
Output voltage range	DC 20 ... 28.8 V (U_e - voltage drop)
Voltage drop	\leq 150 mV (3.8 A) (Input (+))
Nominal output current $I_{o\text{nom}}$	4 x 3.8 A (fixed setting; NEC Class 2 at 20 ... 24 VDC); 4 x 3.2 A (NEC Class 2 (at 28 VDC))
Default setting	DC 3.8 A; switched on
Trip time	16 ms ... 4.7 s (Load-dependent)
Switch-on capacity	> 65000 μ F per channel
Switch-on behavior	Time-delayed channel switching (load-dependent, min. 50 ms / max. 5 s)
Active current limitation	yes
Current limitation	3.8 A (3.2 A at $U_o > 25$ VDC); LPS per NEC Class 2

Subject to changes. Please also observe the further product documentation!

WAGO GmbH & Co. KG
 Hansastr. 27
 32423 Minden
 Phone: +49571 887-0 | Fax: +49571 887-169
 Email: info.de@wago.com | Web: www.wago.com

Do you have any questions about our products?
 We are always happy to take your call at +49 (571) 887-44222.



Signaling and Communication

Signaling	4 x LED (green/red/orange) 1 x Remote control input (S1)
Operation status indicator	Green LED (channel OK) Red LED (tripped channel)
Remote input	Reactivation of all tripped channels via 15 ... 30 VDC pulse for min. 500 ms Switching on/off any number of channels via pulse sequence

Efficiency/power losses

Power loss P_l	$\leq 0.82 \text{ W}; \leq 3.1 \text{ W (4 x 3.8 A)}$
Efficiency (typ.)	99 %

Circuit protection

Internal fuse	No
---------------	----

Safety and protection

Protection class	III
Protection type	IP20; per EN 60529
Reverse voltage protection	No
Pollution degree	2
Transient suppression (primary)	Suppressor diode (33 V)
Parallel operation of single channels	Not permitted
Series operation	No
MTBF	> 500,000 h (per IEC 61709)

Connection data

Connection type 1	Input (+)
Connection technology	Push-in CAGE CLAMP®
WAGO connector	WAGO 831 Series
Solid conductor	0.5 ... 10 mm ² / 20 ... 8 AWG
Fine-stranded conductor	0.5 ... 10 mm ² / 20 ... 8 AWG
Strip length	13 ... 15 mm / 0.51 ... 0.59 inches
Connection type 2	Input (-); Output; Signaling
Connection technology 2	CAGE CLAMP®

Subject to changes. Please also observe the further product documentation!



WAGO connector 2	WAGO 721 Series
Solid conductor 2	0.08 ... 2.5 mm ² / 28 ... 12 AWG
Fine-stranded conductor 2	0.08 ... 2.5 mm ² / 28 ... 12 AWG
Strip length 2	8 ... 9 mm / 0.31 ... 0.35 inches

Physical data

Width	45 mm / 1.772 inches
Height	90 mm / 3.543 inches
Depth from upper-edge of DIN-rail	115.5 mm / 4.547 inches

Mechanical Data

Mounting type	DIN-35 rail
---------------	-------------

Material Data

Fire load	0.651 MJ
Weight	205 g

Environmental requirements

Ambient temperature (operation)	-25 ... +70 °C
Ambient temperature (storage)	-25 ... +85 °C
Relative humidity	5 ... 96 % (no condensation permissible)
Derating	No derating

Standards and specifications

Conformity marking	CE
Standards/specifications	EN 61000-6-2 EN 61000-6-3 UL 508 UL 2367

Commercial data

eCl@ss 10.0	27-37-18-02
eCl@ss 9.0	27-37-18-02
ETIM 8.0	EC001440
ETIM 7.0	EC001440
PU (SPU)	1 pcs

Subject to changes. Please also observe the further product documentation!

WAGO GmbH & Co. KG
Hansastr. 27
32423 Minden
Phone: +49571 887-0 | Fax: +49571 887-169
Email: info.de@wago.com | Web: www.wago.com

Do you have any questions about our products?
We are always happy to take your call at +49 (571) 887-44222.



Packaging type	box
Country of origin	DE
GTIN	4055143896467
Customs tariff number	85363010900

Environmental Product Compliance

RoHS Compliance Status	Compliant, No Exemption
------------------------	-------------------------

Approvals / Certificates

General approvals

Logo	Approval	Additional Approval Text	Certificate name
	EAC Brjansker Zertifizierungsstelle	TP TC 020/2011	EAC_Certificate_RU_C-DE.AM02.B.00115_19

Declarations of conformity and manufacturer's declarations

Logo	Approval	Additional Approval Text	Certificate name
	EU-Declaration of Conformity WAGO GmbH & Co. KG	-	-

















Optional accessories

Ferrule

Ferrule		
	Item no.: 216-203 Ferrule; Sleeve for 1 mm ² / AWG 18; insulated; electro-tin plated; red	www.wago.com/216-203
	Item no.: 216-206 Ferrule; Sleeve for 2.5 mm ² / AWG 14; insulated; electro-tin plated; blue	www.wago.com/216-206
	Item no.: 216-207 Ferrule; Sleeve for 4 mm ² / AWG 12; insulated; electro-tin plated; gray	www.wago.com/216-207
	Item no.: 216-202 Ferrule; Sleeve for 0.75 mm ² / 18 AWG; insulated; electro-tin plated; gray	www.wago.com/216-202
	Item no.: 216-204 Ferrule; Sleeve for 1.5 mm ² / AWG 16; insulated; electro-tin plated; black	www.wago.com/216-204
	Item no.: 216-205	

Subject to changes. Please also observe the further product documentation!

Ferrule; Sleeve for 2.08 mm² / AWG 14; insulated; electro-tin plated; yellowwww.wago.com/216-205

	Item no.: 216-208 Ferrule; Sleeve for 6 mm ² / AWG 10; insulated; electro-tin plated; electrolytic copper; gastight crimped; acc. to DIN 46228, Part 4/09.90; yellow	www.wago.com/216-208
	Item no.: 216-201 Ferrule; Sleeve for 0.5 mm ² / 20 AWG; insulated; electro-tin plated; white	www.wago.com/216-201
	Item no.: 216-223 Ferrule; Sleeve for 1 mm ² / AWG 18; insulated; electro-tin plated; red	www.wago.com/216-223
	Item no.: 216-241 Ferrule; Sleeve for 0.5 mm ² / 20 AWG; insulated; electro-tin plated; electrolytic copper; gastight crimped; acc. to DIN 46228, Part 4/09.90; white	www.wago.com/216-241
	Item no.: 216-242 Ferrule; Sleeve for 0.75 mm ² / 18 AWG; insulated; electro-tin plated; electrolytic copper; gastight crimped; acc. to DIN 46228, Part 4/09.90; gray	www.wago.com/216-242
	Item no.: 216-222 Ferrule; Sleeve for 0.75 mm ² / 18 AWG; insulated; electro-tin plated; gray	www.wago.com/216-222
	Item no.: 216-221 Ferrule; Sleeve for 0.5 mm ² / 20 AWG; insulated; electro-tin plated; white	www.wago.com/216-221
	Item no.: 216-224 Ferrule; Sleeve for 1.5 mm ² / AWG 16; insulated; electro-tin plated; black	www.wago.com/216-224
	Item no.: 216-243 Ferrule; Sleeve for 1 mm ² / AWG 18; insulated; electro-tin plated; electrolytic copper; gastight crimped; acc. to DIN 46228, Part 4/09.90; red	www.wago.com/216-243
	Item no.: 216-244 Ferrule; Sleeve for 1.5 mm ² / AWG 16; insulated; electro-tin plated; electrolytic copper; gastight crimped; acc. to DIN 46228, Part 4/09.90; black	www.wago.com/216-244
	Item no.: 216-263 Ferrule; Sleeve for 1 mm ² / AWG 18; insulated; electro-tin plated; electrolytic copper; gastight crimped; acc. to DIN 46228, Part 4/09.90; red	www.wago.com/216-263
	Item no.: 216-246 Ferrule; Sleeve for 2.5 mm ² / AWG 14; insulated; electro-tin plated; electrolytic copper; gastight crimped; acc. to DIN 46228, Part 4/09.90; blue	www.wago.com/216-246
	Item no.: 216-266 Ferrule; Sleeve for 2.5 mm ² / AWG 14; insulated; electro-tin plated; electrolytic copper; gastight crimped; acc. to DIN 46228, Part 4/09.90; blue	www.wago.com/216-266
	Item no.: 216-264 Ferrule; Sleeve for 1.5 mm ² / AWG 16; insulated; electro-tin plated; electrolytic copper; gastight crimped; acc. to DIN 46228, Part 4/09.90; black	www.wago.com/216-264
	Item no.: 216-284 Ferrule; Sleeve for 1.5 mm ² / AWG 16; insulated; electro-tin plated; electrolytic copper; gastight crimped; acc. to DIN 46228, Part 4/09.90; black	www.wago.com/216-284
	Item no.: 216-286 Ferrule; Sleeve for 2.5 mm ² / AWG 14; insulated; electro-tin plated; electrolytic copper; gastight	www.wago.com/216-286

Subject to changes. Please also observe the further product documentation!

WAGO GmbH & Co. KG

Hansastr. 27

32423 Minden

Phone: +49571 887-0 | Fax: +49571 887-169

Email: info.de@wago.com | Web: www.wago.com

Do you have any questions about our products?

We are always happy to take your call at +49 (571) 887-44222.

crimped; acc. to DIN 46228, Part 4/09.90; blue

**Item no.: 216-287**

Ferrule; Sleeve for 4 mm² / AWG 12; insulated; electro-tin plated; electrolytic copper; gastight crimped; acc. to DIN 46228, Part 4/09.90; gray www.wago.com/216-287

**Item no.: 216-262**

Ferrule; Sleeve for 0.75 mm² / 18 AWG; insulated; electro-tin plated; electrolytic copper; gastight crimped; acc. to DIN 46228, Part 4/09.90; gray www.wago.com/216-262

**Item no.: 216-288**

Ferrule; Sleeve for 6 mm² / AWG 10; insulated; electro-tin plated; electrolytic copper; gastight crimped; acc. to DIN 46228, Part 4/09.90; yellow www.wago.com/216-288

**Item no.: 216-301**

Ferrule; Sleeve for 0.25 mm² / AWG 24; insulated; electro-tin plated; yellow www.wago.com/216-301

**Item no.: 216-321**

Ferrule; Sleeve for 0.25 mm² / AWG 24; insulated; electro-tin plated; yellow www.wago.com/216-321

**Item no.: 216-322**

Ferrule; Sleeve for 0.34 mm² / 22 AWG; insulated; electro-tin plated; light turquoise www.wago.com/216-322

**Item no.: 216-267**

Ferrule; Sleeve for 4 mm² / AWG 12; insulated; electro-tin plated; electrolytic copper; gastight crimped; acc. to DIN 46228, Part 4/09.90; gray www.wago.com/216-267

**Item no.: 216-302**

Ferrule; Sleeve for 0.34 mm² / 22 AWG; insulated; electro-tin plated; light turquoise www.wago.com/216-302

Marking accessories**Marking strip****Item no.: 2009-110**

Marking strips; for Smart Printer; on reel; not stretchable; plain; snap-on type; white www.wago.com/2009-110

**Item no.: 210-831**

Marking strips; on reel; 2.3 mm wide; plain; Self-adhesive; white www.wago.com/210-831

**Item no.: 210-832**

Marking strips; on reel; 3 mm wide; plain; Self-adhesive; white www.wago.com/210-832

Marker**Item no.: 2009-145**

Mini-WSB Inline; for Smart Printer; 1700 pieces on roll; stretchable 5 - 5.2 mm; plain; snap-on type; white www.wago.com/2009-145

**Item no.: 2009-115**

WMB-Inline; for Smart Printer; 1500 pieces on roll; stretchable 5 - 5.2 mm; plain; snap-on type; white www.wago.com/2009-115

**Item no.: 248-501**

Mini-WSB marking card; as card; not stretchable; plain; snap-on type; white www.wago.com/248-501

Subject to changes. Please also observe the further product documentation!

WAGO GmbH & Co. KG

Hansastr. 27

32423 Minden

Phone: +49571 887-0 | Fax: +49571 887-169

Email: info.de@wago.com | Web: www.wago.com

Do you have any questions about our products?

We are always happy to take your call at +49 (571) 887-44222.



Item no.: 793-501

WMB marking card; as card; not stretchable; plain; snap-on type; white

www.wago.com/793-501



Item no.: 793-5501

WMB marking card; as card; for terminal block width 5 - 17.5 mm; stretchable 5 - 5.2 mm; plain; snap-on type; white

www.wago.com/793-5501

Tool

Operating tool



Item no.: 210-721

Operating tool; Blade: 5.5 x 0.8 mm; with a partially insulated shaft; multicoloured

www.wago.com/210-721



Item no.: 210-769

SCREWDRIVER; green

www.wago.com/210-769



Item no.: 210-720

Operating tool; Blade: 3.5 x 0.5 mm; with a partially insulated shaft; multicoloured

www.wago.com/210-720

Downloads

Documentation

Bid Text

787-1664/004-1000 X81 - Datei	2019 Jul 3	xml 7.6 kB	Download
----------------------------------	------------	---------------	----------

787-1664/004-1000 docx - Datei	2019 Jul 2	docx 21.6 kB	Download
-----------------------------------	------------	-----------------	----------

Instruction Leaflet

Elektronische Schutzschalter Elektronische Absicherung, DC 24 V / 4x3,8 A		pdf 624.3 kB	Download
--	--	-----------------	----------

Additional Information

Disposal and Recycling Electrical and electronic equipment, Batteries, Packaging	V 1.1.0 2022 Aug 18	pdf 2.2 MB	Download
---	------------------------	---------------	----------

Libraries

CoDeSys 3.x Library

Subject to changes. Please also observe the further product documentation!



Libraries for CODESYS V3.x	2023-04-26	ZIP	Download
WAGO libraries based on CODESYS V3.x control systems	2023 Apr 26	89.6 MB	
<ul style="list-style-type: none"> ■ WagoAppASi ■ WagoAppCanLayer2 ■ WagoAppCom ■ WagoAppDALI ■ WagoAppDCDriveController ■ WagoAppDigitalImpulseInterface ■ WagoAppEnOcean ■ WagoAppFuse ■ WagoAppHART ■ WagoAppIOLink ■ WagoAppM_Bus ■ WagoAppMP_Bus ■ WagoAppPowerMeasurement ■ WagoAppRTC ■ WagoAppSMI ■ WagoAppSolenoid ■ WagoAppStepper ■ WagoAppVibrationMonitoring 			

CODESYS Control Win V3 x64 is used as a test instance in version 3.5.18.20.

Library			
Anbindung Stromversorgungen Serie 787	1.0.0	zip	Download
Die Bibliothek "WagoLib787_02.lib" stellt Funktionsbausteine und Visualisierungen zur Verfügung, mit deren Hilfe die Informationen der WAGO Stromversorgungsmodule der Serie 787 angezeigt werden können.			
Anbindung Stromversorgungen Serie 787	1.3.0	zip	Download
Die Bibliothek "WagoLib787_01.lib" stellt Funktionsbausteine und Visualisierungen zur Verfügung, mit deren Hilfe die Informationen der WAGO Stromversorgungsmodule der Serie 787 angezeigt werden können.			

CAD/CAE-Data

CAE data

EPLAN Data Portal 787-1664/004-1000	URL	Download
-------------------------------------	-----	----------

Subject to changes. Please also observe the further product documentation!

WAGO GmbH & Co. KG
 Hansastr. 27
 32423 Minden
 Phone: +49571 887-0 | Fax: +49571 887-169
 Email: info.de@wago.com | Web: www.wago.com

Do you have any questions about our products?
 We are always happy to take your call at +49 (571) 887-44222.



WSCAD Universe 787-1664/004-1000	URL	Download
ZUKEN Portal 787-1664/004-1000	URL	Download
WSCAD Universe 787-1664/004-1000	URL	Download
EPLAN Data Portal 787-1664/004-1000	URL	Download
CAD data		
2D/3D Models 787-1664/004-1000	URL	Download

Environmental Product Compliance

Compliance Search

Environmental Product Compliance 787-1664/004-1000	URL	Download
Electronic circuit breaker; 4-channel; 24 VDC input voltage; 3.8 A; active current limitation; NEC Class 2; communication capability		

Installation Notes

Subject to changes. Please also observe the further product documentation!