

# VRP1-20E1A0

## Non-Isolated DC-DC Converter

The VRP1-20E1A0 is a non-isolated DC-DC converter that operates over a wide range of input voltage ( $V_{in} = 4.5 - 13.8$  VDC). This unit can provide a precisely regulated output voltage from 0.591 VDC to 5.1 VDC and can deliver up to 20 A of output current.

This unit is designed to be highly efficient and low cost. The converter is provided in an industry standard package.

### Key Features & Benefits

- 4.5 - 13.8 VDC Input
- 0.591 - 5.1 VDC @ 20 A Output
- Non-Isolated
- High Efficiency
- High Power Density
- Fixed Switching Frequency
- Low Cost
- Excellent Thermal Performance
- Wide Input Voltage Range
- Wide Output Trim Range
- Output Over-Voltage Shutdown
- Power Good Signal
- Remote On/Off
- OCP/SCP
- Class II, Category 2, Isolated DC-DC Converter (refer to IPC-9592B)



### Applications

- Networking
- Computers and Peripherals
- Telecommunications

## 1. MODEL SELECTION

MODEL NUMBER	OUTPUT VOLTAGE	INPUT VOLTAGE	MAX. OUTPUT CURRENT	MAX. OUTPUT POWER	TYPICAL EFFICIENCY
VRP1-20E1A0G	0.591 - 5.1 VDC	4.5 - 13.8 VDC	20 A	100 W	94%

### PART NUMBER EXPLANATION

V	R	P1	-	20	E	1A	0	G
Mounting Type	RoHS Status	Series Name		Output Current	Input Range	Output Voltage	Active Logic	Package Type
Vertical Mount	RoHS	SIP		20 A	4.5 - 13.8 V	0.591 - 5.1 V	Active High	Tray Package

## 2. ABSOLUTE MAXIMUM RATINGS

PARAMETER	DESCRIPTION	MIN	TYP	MAX	UNITS
Input Voltage (continuous)		-0.3	-	15	V
Output Enable Terminal Voltage		-0.3	-	5.5	V
Ambient temperature		0	-	85	°C
Storage Temperature		-40	-	125	°C
Altitude		-	-	2000	m

**NOTE:** Ratings used beyond the maximum ratings may cause a reliability degradation of the converter or may permanently damage the device.

## 3. INPUT SPECIFICATIONS

All specifications are typical at 25°C unless otherwise stated.

PARAMETER	DESCRIPTION	MIN	TYP	MAX	UNIT
Operating Input Voltage	$V_o < 3.45\text{ V}$	4.5	12	13.8	V
	$V_o \geq 3.45\text{ V}$	$1.3 \cdot V_o$	12	13.8	V
Input Current (full load)	An input line fuse must always be used.	-	-	20	A
Input Current (no load)		-	150	300	mA
Remote Off Input Current		-	50	-	mA
Input Reflected Ripple Current (pk-pk)	Use a 1000 $\mu\text{F}$ AL-Cap on the input.	-	50	100	mA
Input Reflected Ripple Current (rms)		-	20	40	mA
$I^2t$ Inrush Current Transient		-	-	1	$\text{A}^2\text{s}$
Turn-on Voltage Threshold		-	4.2	-	V
Turn-off Voltage Threshold	A 30.1 k resistor is connected from Enable to $V_{in}$	-	3.9	-	V

**NOTE:** All specifications are typical at 25 °C unless otherwise stated.

## 4. OUTPUT SPECIFICATIONS

All specifications are typical at nominal input, full load at 25°C unless otherwise stated.

PARAMETER	DESCRIPTION	MIN	TYP	MAX	UNIT
Output Voltage Set Point Accuracy	Setpoint test condition: $V_{in} = 12\text{ V}$ , $I_{out} = \text{half load}$ .	-1.5	-	1.5	% $V_{o.set}$
Load Regulation		-	-	1	% $V_{o.set}$
Line Regulation		-	-	0.5	% $V_{o.set}$
Regulation Over Temperature (0°C to 85°C)		-	-	1	% $V_{o.set}$
Output Current Range		0	-	20	A
Output DC Current Limit		-	150	-	% $I_{out}$
Output Ripple and Noise (pk-pk)	Test condition: 0-20MHz BW, with a 1 $\mu\text{F}$ ceramic capacitor and a 10 $\mu\text{F}$ Tantalum cap at output.	-	40	80	mV
Output Ripple and Noise (rms)		-	20	40	mV
Output Short-Circuit Current		-	1	3	A <sup>2</sup> s
Turn On Time <sup>2</sup>	$V_{out} = 5.0\text{V}$ ; time from enable going high to 90% of $V_{out}$	1	-	3	ms
	$V_{out} = 3.3\text{V}$ ; time from enable going high to 90% of $V_{out}$	1	-	3	ms
	$V_{out} = 1.8\text{V}$ ; time from enable going high to 90% of $V_{out}$	1	-	3	ms
	$V_{out} = 0.9\text{V}$ ; time from enable going high to 90% of $V_{out}$	1	-	3	ms
Rise Time <sup>2</sup>	$V_{out} = 5.0\text{V}$ ; time from 10% to 90% of $V_{out}$	-	1.08	1.58	ms
	$V_{out} = 3.3\text{V}$ ; time from 10% to 90% of $V_{out}$	-	0.99	1.49	ms
	$V_{out} = 1.8\text{V}$ ; time from 10% to 90% of $V_{out}$	-	0.93	1.43	ms
	$V_{out} = 0.9\text{V}$ ; time from 10% to 90% of $V_{out}$	-	0.90	1.40	ms
Overshoot at Turn on and off		-	-	5	%
Output Capacitance		0	-	1000	$\mu\text{F}$
<b>Transient Response</b>					
50% ~ 75% Max Load		-	200	300	mV
Settling Time	$V_o = \text{All}$	Test condition: $di/dt = 2.5\text{ A}/\mu\text{s}$ ;		50	$\mu\text{s}$
75% ~ 50% Max Load		$V_{in} = 12\text{ V}$ ; with 10 $\mu\text{F}$ tantalum cap and 1 $\mu\text{F}$ ceramic at the output, $T_a = 25^\circ\text{C}$		200	300
Settling Time		-	-	50	$\mu\text{s}$

**NOTE:** 1. All specifications are typical at normal input, full load at  $T_a = 25^\circ\text{C}$  unless otherwise stated.

2. The turn on time is guaranteed to be in between the minimum and maximum limits specified over entire operating temperatures. Output capacitance used was 4 x 470  $\mu\text{F}$  polymer and 4 x 47  $\mu\text{F}$  ceramic. The turn on waveform with parameter measurement locations is shown below.

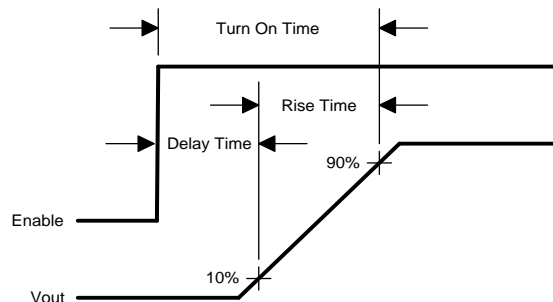

Asia-Pacific  
+86 755 298 85888

Europe, Middle East  
+353 61 49 8941

North America  
+1 866 513 2839

## 5. GENERAL SPECIFICATIONS

PARAMETER	DESCRIPTION	MIN	TYP	MAX	UNIT	
Efficiency	Vo = 5.0 V	-	94	-	%	
	Vo = 3.3 V	-	92	-	%	
	Vo = 2.5 V	The efficiency is measured at Vin = 12 V, full load.		-	90	%
	Vo = 1.5 V	-	85	-	%	
	Vo = 0.591 V	-	70	-	%	
Switching Frequency		-	500	-	kHz	
Output Voltage Trim Range		0.591	-	5.1	V	
Remote Sense Compensation	Vin=12 V, full load.	-	-	0.2	V	
MTBF	Calculated Per Bell Core SR-332 (Io = 80% Iomax; Vin = 12 V; Ta = 25 °C)	-	19310000	-	hrs	
Weight		-	9.7	-	g	
Dimensions (L x W x H)			1.45 x 0.40 x 0.61		inch	
			36.83 x 10.16 x 15.49		mm	

## 6. CONTROL SPECIFICATIONS

PARAMETER	DESCRIPTION	MIN	TYP	MAX	UNIT
<i>Remote On/Off (Active High)</i>					
Turn On Voltage Threshold	Unit is on when voltage on enable pin is driven above the turn on threshold. When enable pin is floating, unit is off.	0.492	0.510	0.526	V
Maximum Enable Voltage	Maximum voltage that should be applied to the enable pin.	-	-	5.5	V
Hysteresis Source Current	A 10 uA current source to GND (IEN_HYS) is active when unit is off and inactive when unit is on (see figure below).	7.5	10	11.5	µA
<i>PwGood (PowerGood)'</i>					
PwGood = High = Power Good		2.4	-	6	V
		-	-	2	mA
PwGood = Low = Power Not Good		0	-	0.35	V
		-	-	5	mA

**Note 1:** PwGood is an open drain output signal. An external pull up is required. Pull up voltage should not exceed 6 V.

7. EFFICIENCY DATA

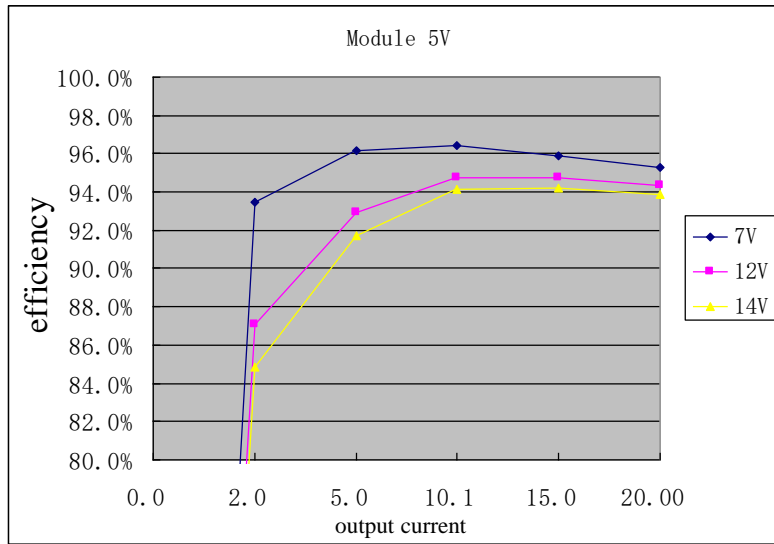

Figure 1. Efficiency data at  $V_o = 5\text{ V}$

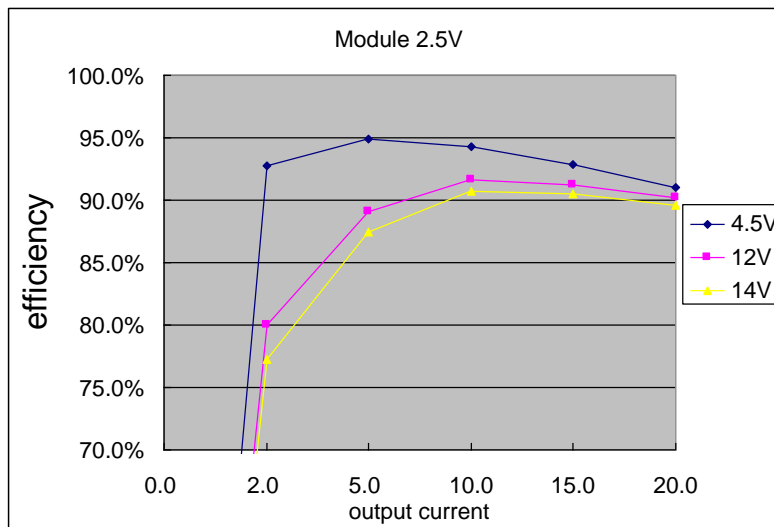

Figure 2. Efficiency data at  $V_o = 2.5\text{ V}$

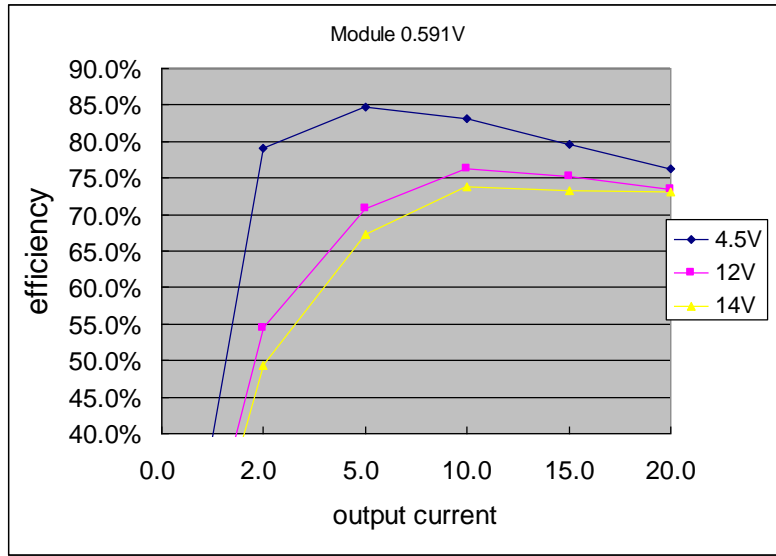

Figure 3. Efficiency data at Vo = 0.591 V

### 8. OUTPUT TRIM EQUATION

The Rtrim resistor should be connected between the Trim pin and GND pin.

$$R_{trim} = \left[ \frac{1.182}{V_o - 0.591} \right]$$

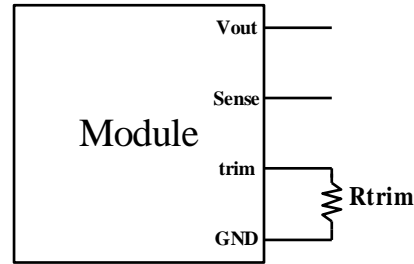

Figure 4. Trim circuit

## 9. THERMAL DERATING CURVE

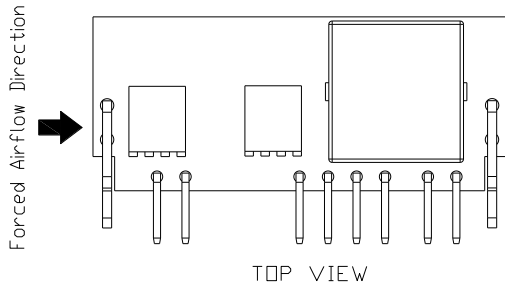

Figure 5. Airflow direction

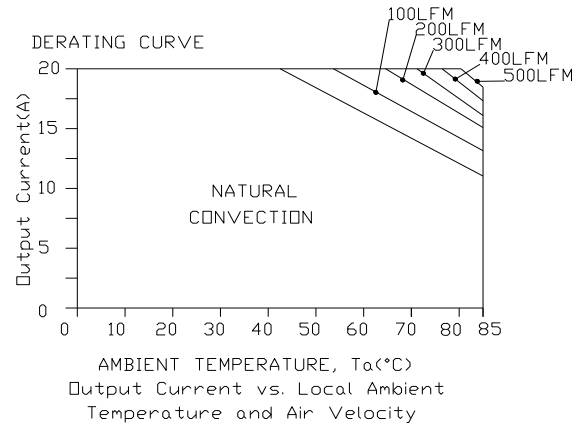

Figure 6.  $V_{out} = 0.591 V$

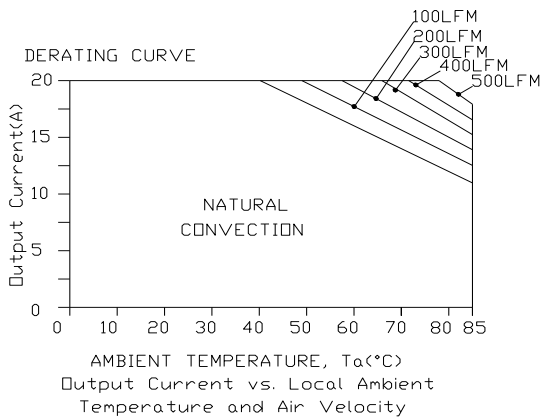

Figure 7.  $V_{out} = 1.2 V$

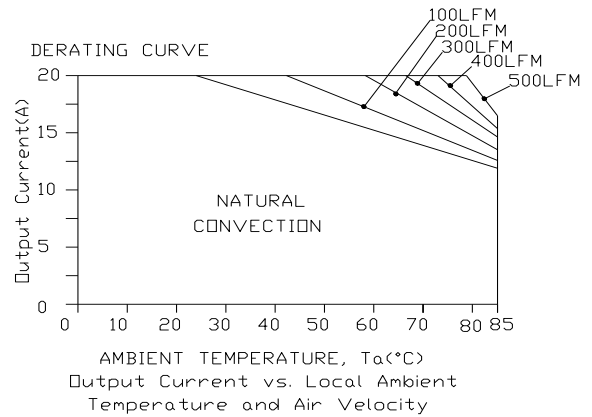

Figure 8.  $V_{out} = 2.5 V$

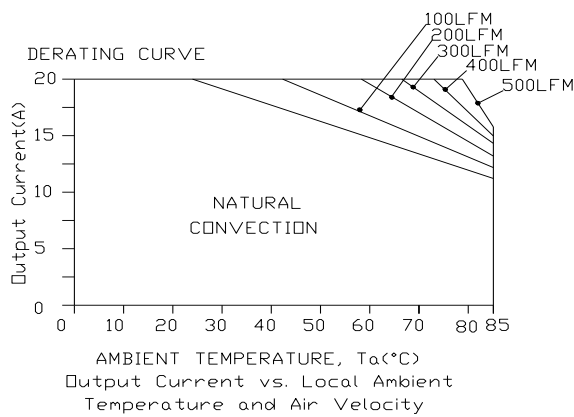

Figure 9.  $V_{out} = 3.3 V$

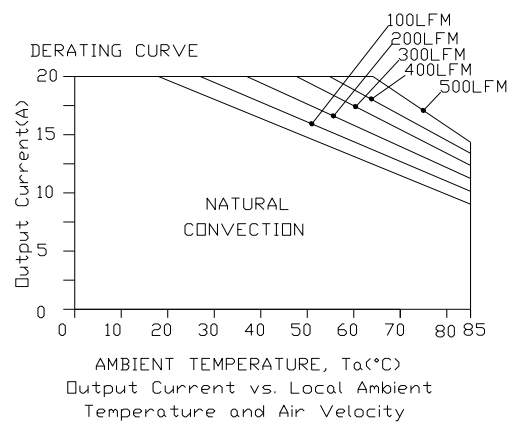

Figure 10.  $V_{out} = 5 V$

### 10. TRANSIENT RESPONSE WAVEFORMS

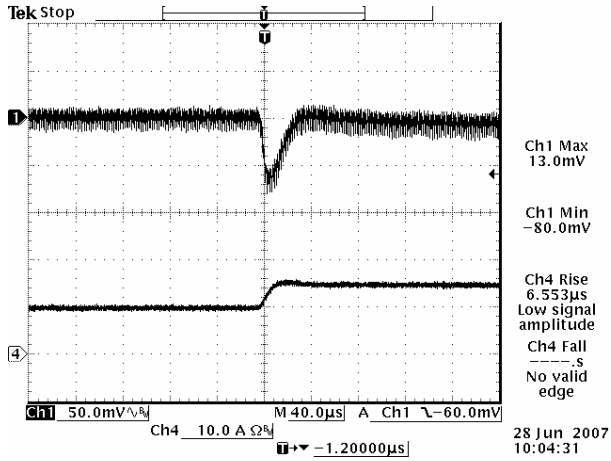

Figure 11. Vout = 2.5 V, 50%-75% Load Transients

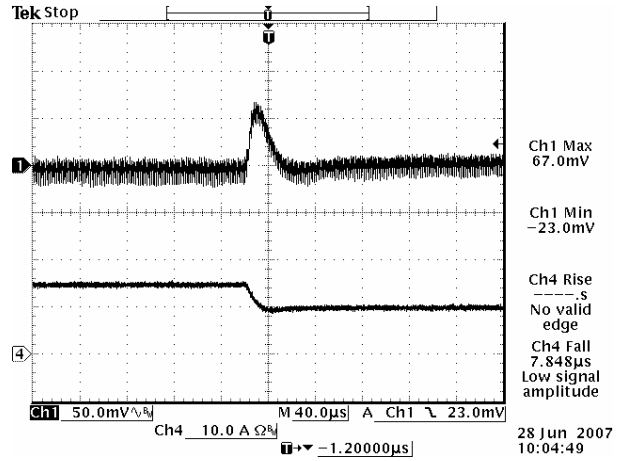

Figure 12. Vout = 2.5 V, 75%-50% Load Transients

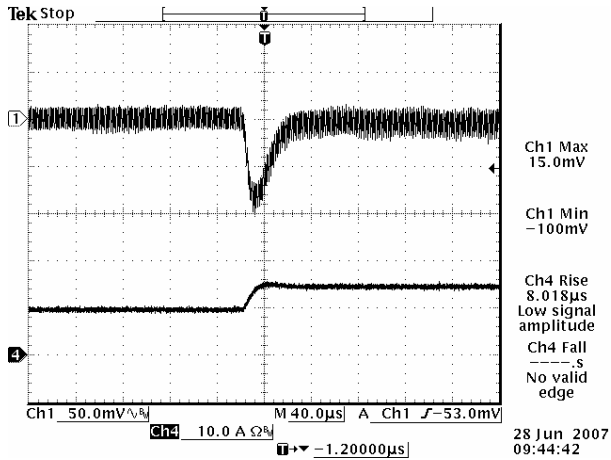

Figure 13. Vout = 5 V, 50%-75% Load Transients

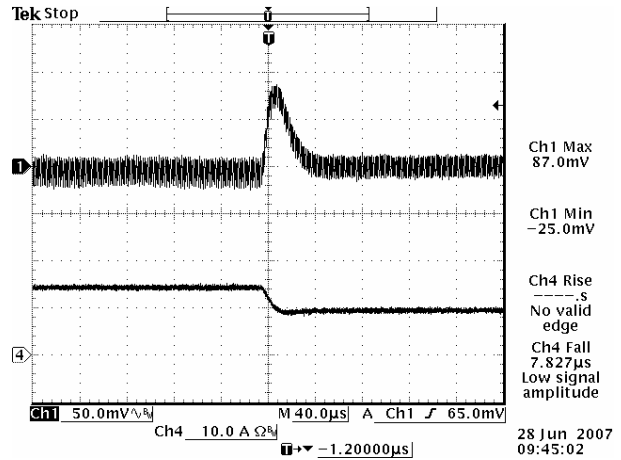

Figure 14. Vout = 5 V, 75%-50% Load Transients

**Note:** Transient response at di/dt = 2.5 A/us, with 1 µF ceramic capacitor at the output, and Ta = 25°C.



11. RIPPLE AND NOISE

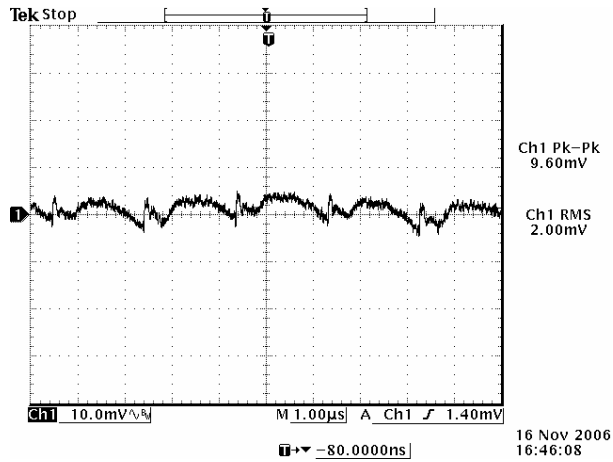

Figure 15. 12 VDC input, 0.591 VDC output

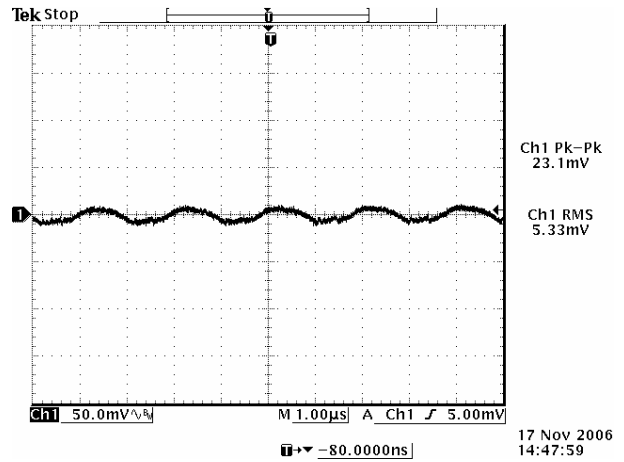

Figure 16. 12 VDC input, 2.5 VDC output

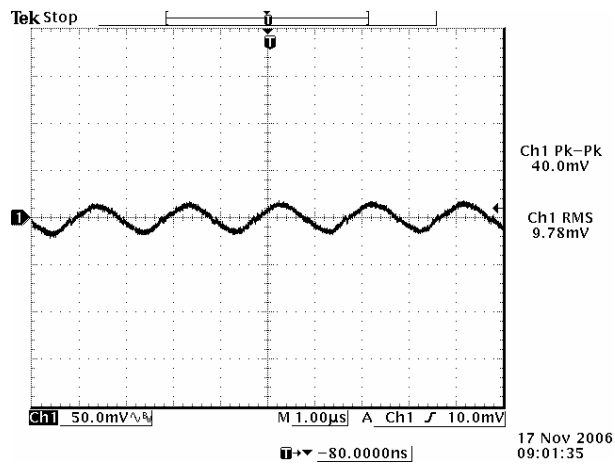

Figure 17. 12 VDC input, 5 VDC output

**Note:** Ripple and noise at full load, 0-20 MHz BW, with a 10 µF tantalum cap and a 1 µF ceramic cap, and Ta = 25°C.

## 12. MECHANICAL DIMENSIONS

### OUTLINE

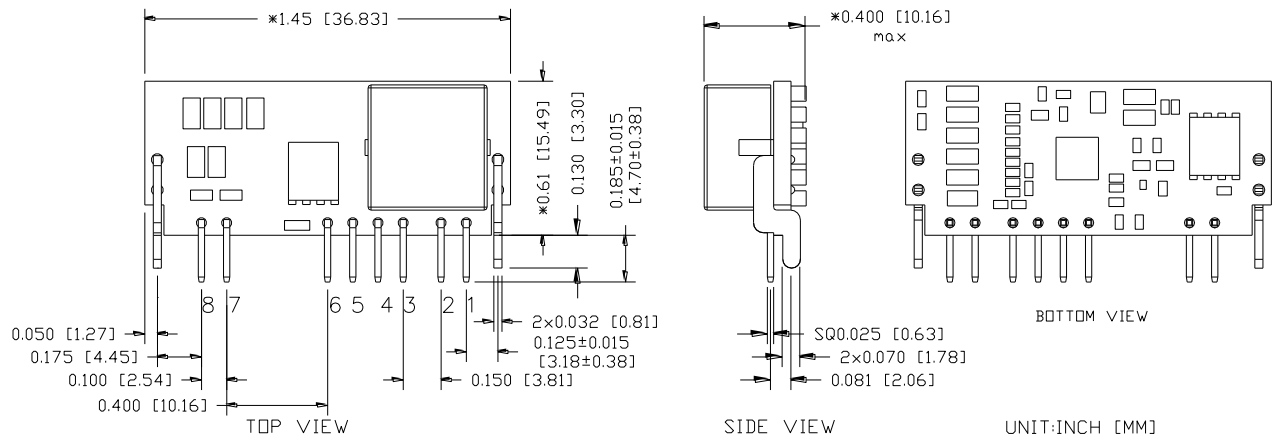

Figure 18. Outline

**Note:** This module is recommended and compatible with Pb-Free Wave Soldering and must be soldered using a peak solder temperature of no more than 260°C for less than 5 seconds.

**Notes:**

- 1) All Pins: Material – Copper Alloy;  
Finish – Gold plated.
- 2) Un-dimensioned components are shown for visual reference only.
- 3) All dimensions in inch [mm]; Tolerances: x.xx +/-0.02 inch [0.51 mm], x.xxx +/-0.010 inch [0.25 mm].

## PIN DEFINITIONS

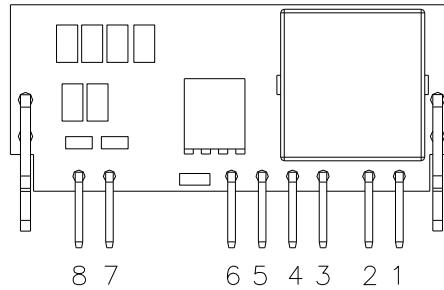

Figure 19. Pins

PIN	FUNCTION	PIN	FUNCTION
1	Vout	5	Enable
2	Trim	6	Vin
3	GND	7	Sense+
4	PwGOOD	8	Sense-

## RECOMMENDED PAD LAYOUT

### RECOMMENDED PCB LAYOUT

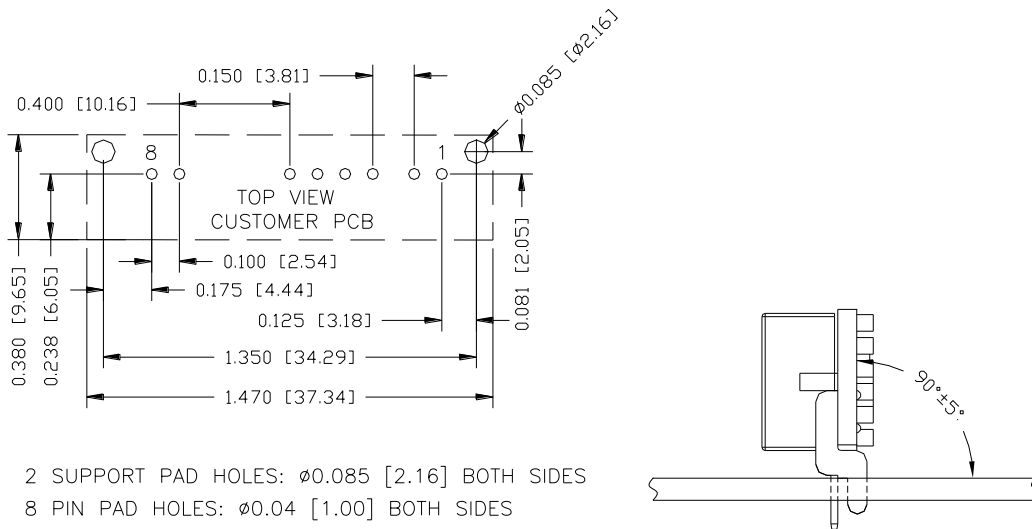

Figure 20. Recommended pad layout

### 13. REVISION HISTORY

DATE	REVISION	CHANGES DETAIL	APPROVAL
2010-04-16	I	Add part number 0RP1-20E1A0.	J.Fan
2013-04-11	J	Update Output Spec and Control Spec.	J.Fan
2014-06-09	K	Update MD.	J.Fan
2014-09-02	L	Update MTBF.	XF.Jiang
2016-01-05	M	Add Assembly Note. Update mechanical drawing.	XF.Jiang
2018-03-12	AN	Update the form and TD.	XF.Jiang
2018-05-23	AO	Add Control Specs Note.	XF.Jiang
2021-08-02	AP	Add object ID and thermal test airflow direction.	XF.Jiang

For more information on these products consult: [tech.support@psbel.com](mailto:tech.support@psbel.com)

**NUCLEAR AND MEDICAL APPLICATIONS** - Products are not designed or intended for use as critical components in life support systems, equipment used in hazardous environments, or nuclear control systems.

**TECHNICAL REVISIONS** - The appearance of products, including safety agency certifications pictured on labels, may change depending on the date manufactured. Specifications are subject to change without notice.



[tech.support@psbel.com](mailto:tech.support@psbel.com)  
[belfuse.com/power-solutions](http://belfuse.com/power-solutions)