

**PLEASE CHECK WWW.MOLEX.COM FOR LATEST PART INFORMATION**

**Part Number:** [0395224018](#)  
**Status:** **Active**  
**Overview:** Eurostyle Terminal Blocks  
**Description:** 5.00mm Pitch Eurostyle Horizontal PCB Header, Surface Mount Compatible, 18 Circuits

**Documents:**

[3D Model](#) [Product Specification PS-39500-001-001 \(PDF\)](#)  
[Drawing \(PDF\)](#) [RoHS Certificate of Compliance \(PDF\)](#)

**Agency Certification**

UL E48521

**General**

Product Family Terminal Blocks  
 Series [39522](#)  
 Application N/A  
 Component Type PCB Header  
 Overview [Eurostyle Terminal Blocks](#)  
 Product Name ESE, Eurostyle Pluggable  
 Type Euro Block  
 UPC 822350444811

**Physical**

Circuits (Loaded) 18  
 Entry Angle N/A  
 Lock to Mating Part Yes  
 Number of Rows 1  
 Orientation Horizontal  
 PC Tail Length 3.90mm  
 PCB Thickness - Recommended 3.20mm  
 Panel Mount No  
 Pitch - Mating Interface 5.00mm  
 Pitch - Termination Interface 5.00mm  
 Polarized to Mating Part Yes  
 Shrouded Closed Ends  
 Stackable No  
 Surface Mount Compatible (SMC) Yes  
 Temperature Range - Operating -40° to +140°C  
 Wire Size AWG N/A

**Electrical**

Current - Maximum per Contact 15.0A  
 Voltage - Maximum 300V

**Solder Process Data**

Lead-free Process Capability N/A

**Material Info**

**Reference - Drawing Numbers**

Product Specification PS-39500-001-001  
 Sales Drawing SD-39522-001-001

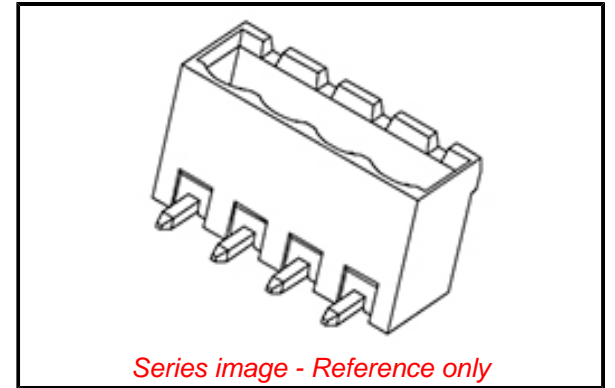

**EU ELV**

**Not Relevant**

**EU RoHS**

**Not Reviewed**

**REACH SVHC**

Not Contained Per -  
 ED/30/2017 (7 July  
 2017)

**Halogen-Free**

**Status**

**Low-Halogen**

For more information, please visit [Contact US](#)

China ROHS

ELV

RoHS Phthalates

**China RoHS**

Green Image

Not Relevant

Not Contained

**Search Parts in this Series**

[39522](#) Series

**Mates With**

[39520](#) Horizontal Plug, [39523](#) Vertical Plug,  
 Most 5.00mm Pitch Industry Standard Plugs