

FINISH TYPE	"0" TIN	"1" 15MICROINCH GOLD	"2" 30MICROINCH GOLD				
CKT	HDR ASSY PN	HDR ASSY PN	HDR ASSY PN	A	B	C	D
2	2189890200	2189890201	2189890202	9.65	3.00	14.20	2.95
3	2189890300	2189890301	2189890302	12.65	6.00	17.20	2.95
4	2189890400	2189890401	2189890402	15.65	9.00	20.20	7.70
5	2189890500	2189890501	2189890502	18.65	12.00	23.20	10.70

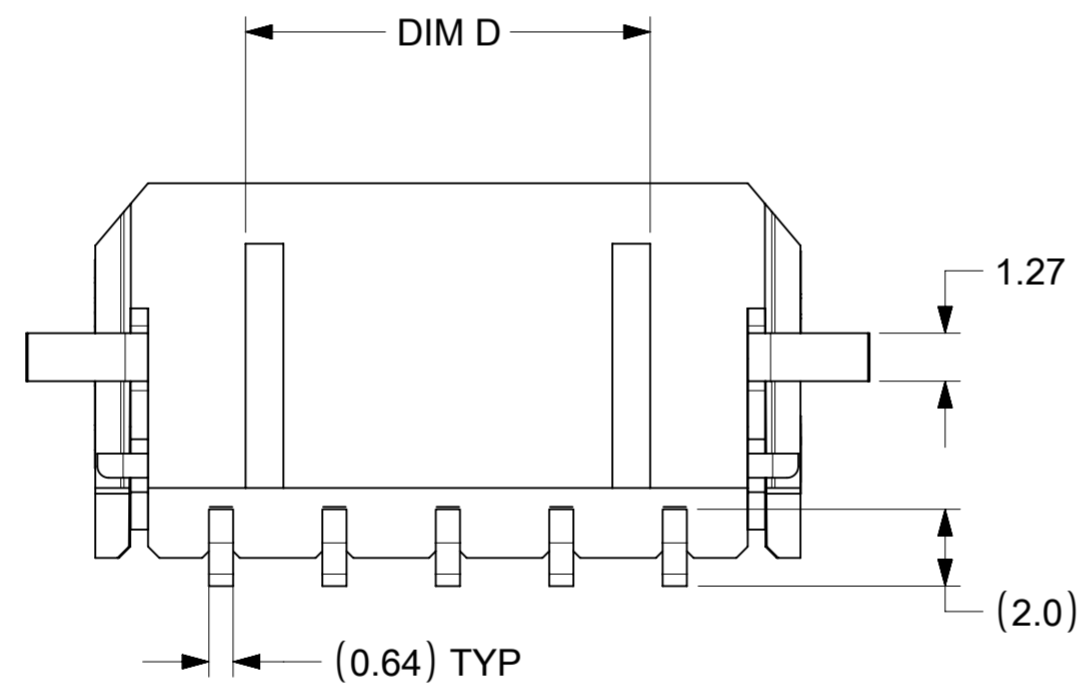
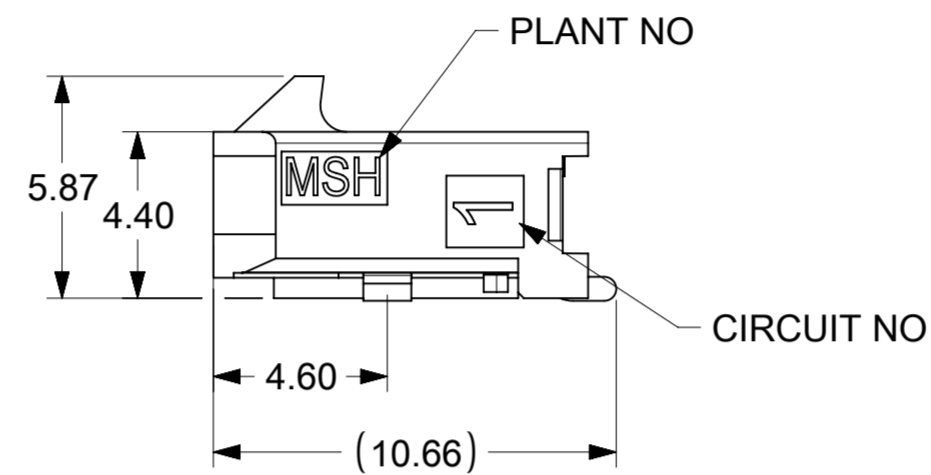
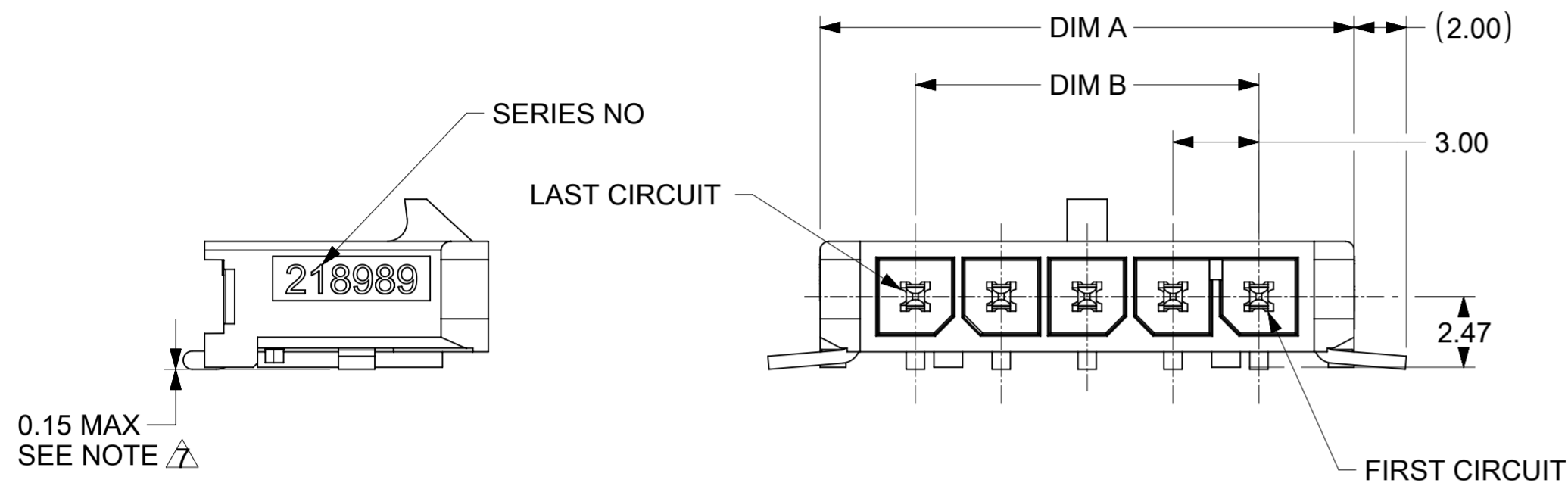

NOTES:

- HOSING MATERIAL: GLASS FILLED LIQUID CRYSTAL POLYMER, UL 94V-0, COLOR: BLACK
TERMINAL MATERIAL: HIGH COPPER ALLOY
- FINISH:
OPTION "0": REFLOW MATTE TIN OVER NICKEL
OPTION "1": SELECT 15MICROINCH GOLD AND SELECT MATTE TIN OVER NICKEL.
OPTION "2": SELECT 30MICROINCH GOLD AND SELECT MATTE TIN OVER NICKEL.
- PRODUCT SPECIFICATION : 2064600000-PS
- PRODUCT TEST SUMMARY: 2064600000-TS
- T&R PACK : 2189890001-PK
- MATE WITH RECEPTACLE 215759
- THE COPLANARITY DIMENSION IS ESTABLISHED BY PLACING THE ASSEMBLY ON A FLAT SURFACE. THE DISTANCE FROM THAT SURFACE TO THE BOTTOM OF ANY TERMINAL OR NAIL MUST NOT EXCEED 0.15
- THIS PART CONFORMS TO CLASS 'B' REQUIREMENTS OF COSMETIC SPECIFICATION PS-45499-002.
- METAL TAB MAY BE FLUSH WITH PCB. NO EXPOSED TRACES OR VIAS ALLOWED NEAR THESE AREAS.

LEGEND

218989 - * * * *

SERIES NO. _____

CKT NO. _____

OPTION
0: RIGHT ANGLE WITH NAIL
1: RIGHT ANGLE WITH CLIP
2: VERTICAL WITH NAIL
3: VERTICAL WITH CLIP

PLATING OPTION
0: TIN
1: 15MICROINCH AU
2: 30MICROINCH AU

THIS DRAWING CONTAINS INFORMATION THAT IS PROPRIETARY TO MOLEX ELECTRONIC TECHNOLOGIES, LLC AND SHOULD NOT BE USED WITHOUT WRITTEN PERMISSION									
DIMENSION UNITS	SCALE	CURRENT REV DESC:				molex			
mm	NTS								
GENERAL TOLERANCES (UNLESS SPECIFIED)						MICRO-FIT + SINGLE ROW RIGHT ANGLE SMT HEADER WITH NAIL			
ANGULAR TOL	± 3.0°								
4 PLACES	±	EC NO: 724761			PRODUCT CUSTOMER DRAWING				
3 PLACES	±	DRWN: ZIXUAQ	2022/09/08						
2 PLACES	± 0.25	CHK'D: XQZHANG	2022/10/17		DOCUMENT NUMBER: 2189890000-SD				
1 PLACE	± 0.36	APPR: XQZHANG	2022/10/17						
0 PLACES	±	INITIAL REVISION:				DOC TYPE: PSD	DOC PART: 000	REVISION: A	
DRAFT WHERE APPLICABLE MUST REMAIN WITHIN DIMENSIONS		THIRD ANGLE PROJECTION	DRAWING	SERIES	MATERIAL NUMBER	CUSTOMER	SHEET NUMBER		
			A2-SIZE	218989	SEE TABLE	GENERAL MARKET	1 OF 2		

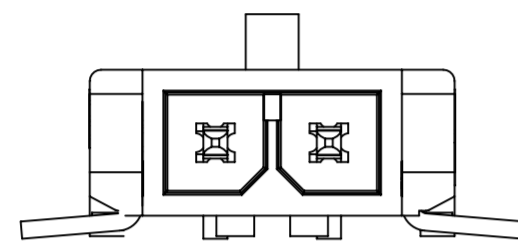

2CKT

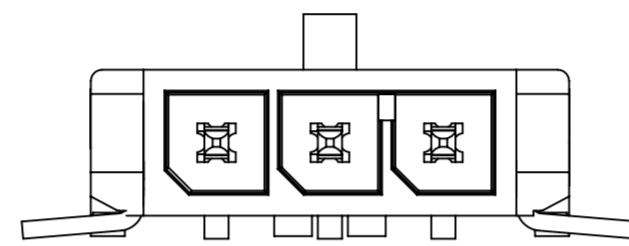

4CKT

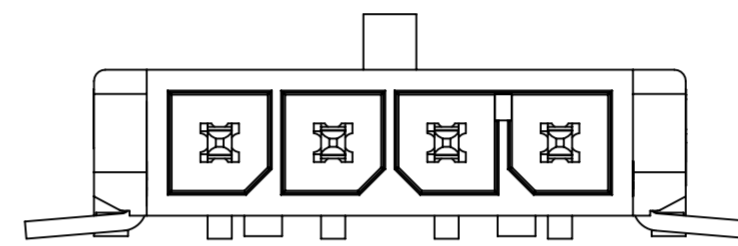

6CKT

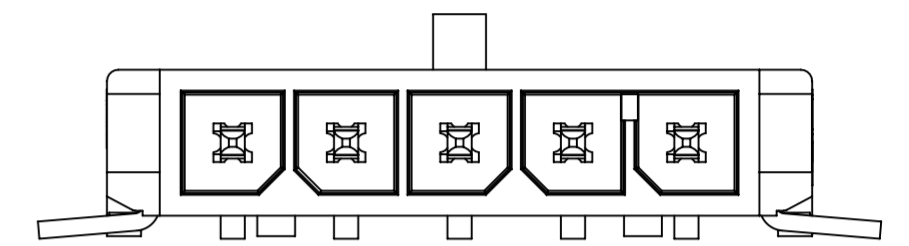

8CKT

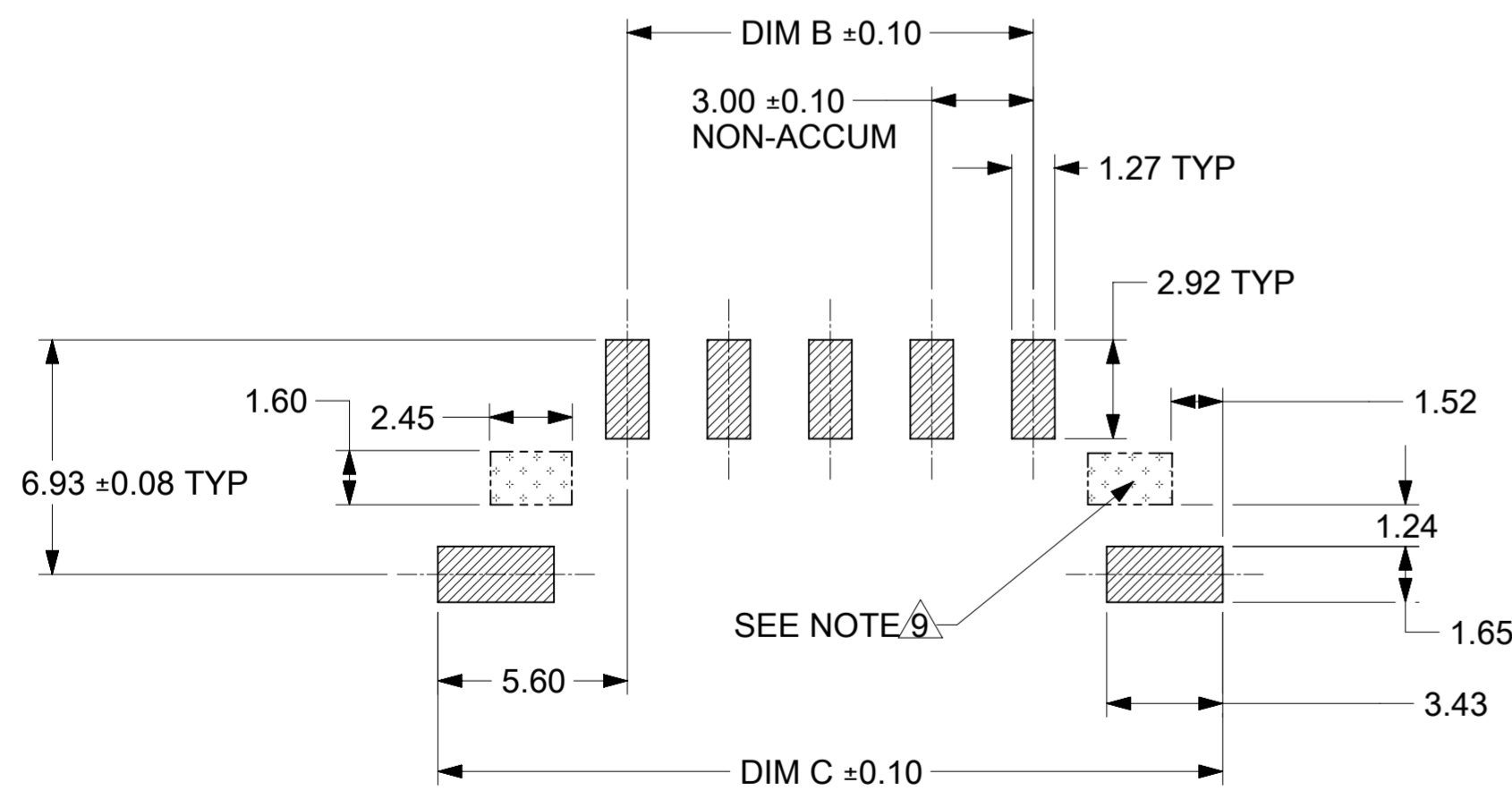

PCB LAYOUT: COMPONENT SIDE
RECOMMEND PCB THICKNESS: 1.60±0.05MM

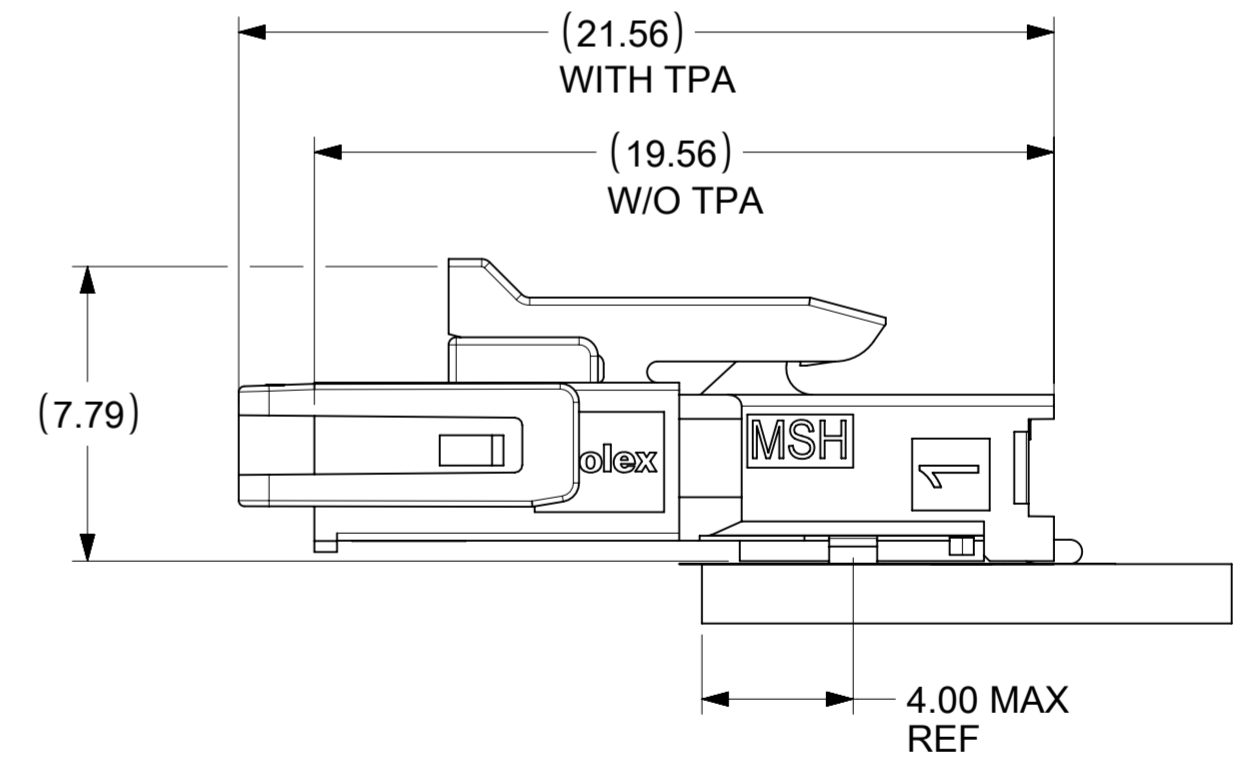

THIS DRAWING CONTAINS INFORMATION THAT IS PROPRIETARY TO MOLEX ELECTRONIC TECHNOLOGIES, LLC AND SHOULD NOT BE USED WITHOUT WRITTEN PERMISSION									
DIMENSION UNITS	SCALE	CURRENT REV DESC:							
mm	NTS								
GENERAL TOLERANCES (UNLESS SPECIFIED)					MICRO-FIT + SINGLE ROW RIGHT ANGLE SMT HEADER WITH NAIL				
ANGULAR TOL	±	3.0°							
4 PLACES	±		EC NO: 724761	2022/09/08	PRODUCT CUSTOMER DRAWING				
3 PLACES	±		DRWN: ZIXUAQ	2022/10/17					
2 PLACES	±	0.25	CHK'D: XQZHANG	2022/10/17					
1 PLACE	±	0.36	APPR: XQZHANG	2022/10/17	2189890000-SD				
0 PLACES	±		INITIAL REVISION:						
DRAFT WHERE APPLICABLE MUST REMAIN WITHIN DIMENSIONS		THIRD ANGLE PROJECTION	DRAWING	SERIES	MATERIAL NUMBER	CUSTOMER	DOC TYPE	DOC PART	REVISION
			A2-SIZE	218989	SEE TABLE	GENERAL MARKET	PSD	000	A

DOCUMENT STATUS	P1	RELEASE DATE	2022/10/17	06:34:12
-----------------	----	--------------	------------	----------