

Data sheet | Item number: 756-3205/140-100

Connecting cable; 14-pole; Length: 10 m

www.wago.com/756-3205/140-100



Color: ■

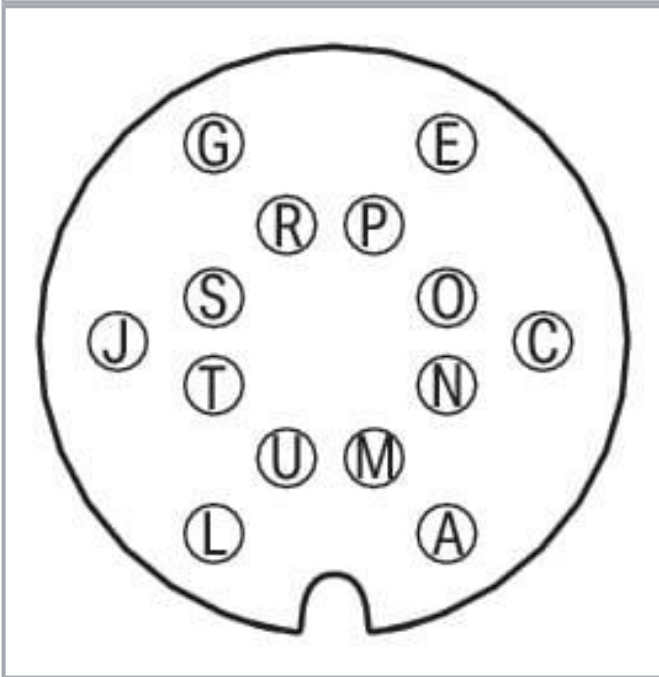
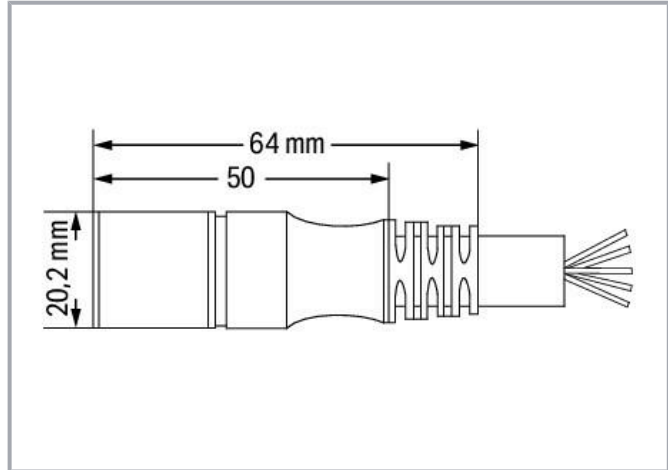

Pin A, L: 0.75 mm²

Pin C - J, N - T: 0.34 mm²

A	brown	N	pink-brown
C	white-pink	O	violet
E	black	P	white
G	pink	R	red
J	green	S	gray
L	blue	T	yellow
M	commoned with A	U	commoned with L

Subject to changes. Please also observe the further product documentation!

WAGO GmbH & Co. KG

Hansastr. 27

32423 Minden

Phone: +49571 887-0 | Fax: +49571 887-169

Email: info.de@wago.com | Web: www.wago.com

Do you have any questions about our products?

We are always happy to take your call at +49 (571) 887-44222.



Data

Technical data

Connection type	M16 socket - free end
Pole number	14
Cable connection direction to mating direction	0 °
Cable length	10 m
Operating voltage	150 V
Operating current	4 A
Operating current	6 mm ² 0,75 A
Rated surge voltage	1.2 kV

Mechanical Data

Bending cycles	2 Mio.
Drag chain capability	yes
Sheathed cable diameter	8.9 ... 9.3 mm
Weight	1090 g
Color	black

Environmental requirements

Ambient (operating) temperature (dynamic)	-30 ... +90 °C
Ambient (operating) temperature (static)	-40 ... +90 °C
Protection type	IP67

Commercial data

eCl@ss 10.0	27-06-03-11
eCl@ss 9.0	27-06-03-11
ETIM 8.0	EC001855
ETIM 7.0	EC001855
PU (SPU)	1 pcs
Packaging type	box
Country of origin	DE
GTIN	4044918978514
Customs tariff number	85444290900

Subject to changes. Please also observe the further product documentation!

WAGO GmbH & Co. KG
 Hansastr. 27
 32423 Minden
 Phone: +49571 887-0 | Fax: +49571 887-169
 Email: info.de@wago.com | Web: www.wago.com

Do you have any questions about our products?
 We are always happy to take your call at +49 (571) 887-44222.



Environmental Product Compliance

RoHS Compliance Status

Compliant, No Exemption

Downloads

Documentation

System Description

Sensor/Actuator Boxes – General Product Information

pdf
438.6 kB

[Download](#)

CAD/CAE-Data

CAE data

WSCAD Universe 756-3205/140-100

[URL](#)

[Download](#)

WSCAD Universe 756-3205/140-100

[URL](#)

[Download](#)

Environmental Product Compliance

Compliance Search

Environmental Product Compliance 756-3205/140-100

[URL](#)

[Download](#)

Connecting cable; 14-pole; Length: 10 m

Installation Notes

Subject to changes. Please also observe the further product documentation!

WAGO GmbH & Co. KG

Hansastr. 27

32423 Minden

Phone: +49571 887-0 | Fax: +49571 887-169

Email: info.de@wago.com | Web: www.wago.com

Do you have any questions about our products?

We are always happy to take your call at +49 (571) 887-44222.