

# Datasheet

RC1880-GPR

### Product Description

The RC1880-GPR is a sub-1 GHz co-processor module for RIIoT (Radiocrafts Industrial Internet of Things) gateways. It interfaces gateways with the RIIoT wireless network. The RC1880-GPR will function as the concentrator in the RIIoT network and the gateway can connect each node in the RIIoT network to the cloud.



The module contains a complete IEEE802.15.4g/e compliant stack which is accessed through an API via UART. Through the free middleware, *RIIoT Net Controller*, the interface to the RIIoT network is accessible through a local socket interface. This enables easy development of customer applications that can include fog computing or cloud connection through MQTT or RESTful HTTP.

The RC1880-GPR will always be the concentrator in an IEEE 802.15.4g/e network and be responsible for creating the network, setting the network and security policies.

### Applications

- Gateway for RIIoT
- Concentrator in a closed RIIoT network

### Features

- Closely bound with the RIIoT Net Controller middleware that enables socket interface for customer application
- Based on open standards IEEE 802.15.4 g/e
- Frequency hopping option
- AES128 network/MAC and application security
- Reliable communication, Automatic acknowledge and retransmission
- Broadcast support
- 8 km Line-of-sight range in 5 kb/s mode
- OTA (Over The Air) FW upgrade support
- Covers both 868 MHz for CE compliance (Europe++) and 915 MHz for FCC compliance (US++)

### Quick Reference Data (typical at 3.6V, 868 MHz, 50 kb/s)

Parameter	RC1880-SPR	Unit
Frequency band	862-930	MHz
Max output power	14	dBm
Sensitivity (BER 1%) @50kb/s	-110	dBm
Supply voltage	1.8 - 3.8	V
Current consumption, RX/TX	6.2 / 26.5	mA
Current consumption, Shutdown	185	nA
Flash memory	128	kB
RAM	20	kB
Internal EEPROM (optional)	4	kB
Internal SPI Flash(optional)	256	kB
Operating Temperature	-40 to +85	°C

### RIIoT network

The RIIoT network consists of some key elements

- The *RC1880-SPR* module
  - o The module can be programmed to the customer specific application behaviour, through the SPR Software Development Kit(SDK)
- The *SPR SDK*
  - o Software development kit with application framework and tools for building and uploading user application to the RC1880-SPR module
- The *RC1880-GPR* module for use in the gateway/concentrator
  - o Support the concentrator or the gateway. Normally connected to a Linux gateway, but can also be controlled by MCU through a UART protocol
- The *RIIoT Net Controller* Linux middleware
  - o A middleware SW that can be used on a Linux gateway. Interfaces the RC1880-GPR module and supply user application a socket interface for controlling and sending/receiving data through the wireless network.

Below is an illustration of the different element and the documentation available

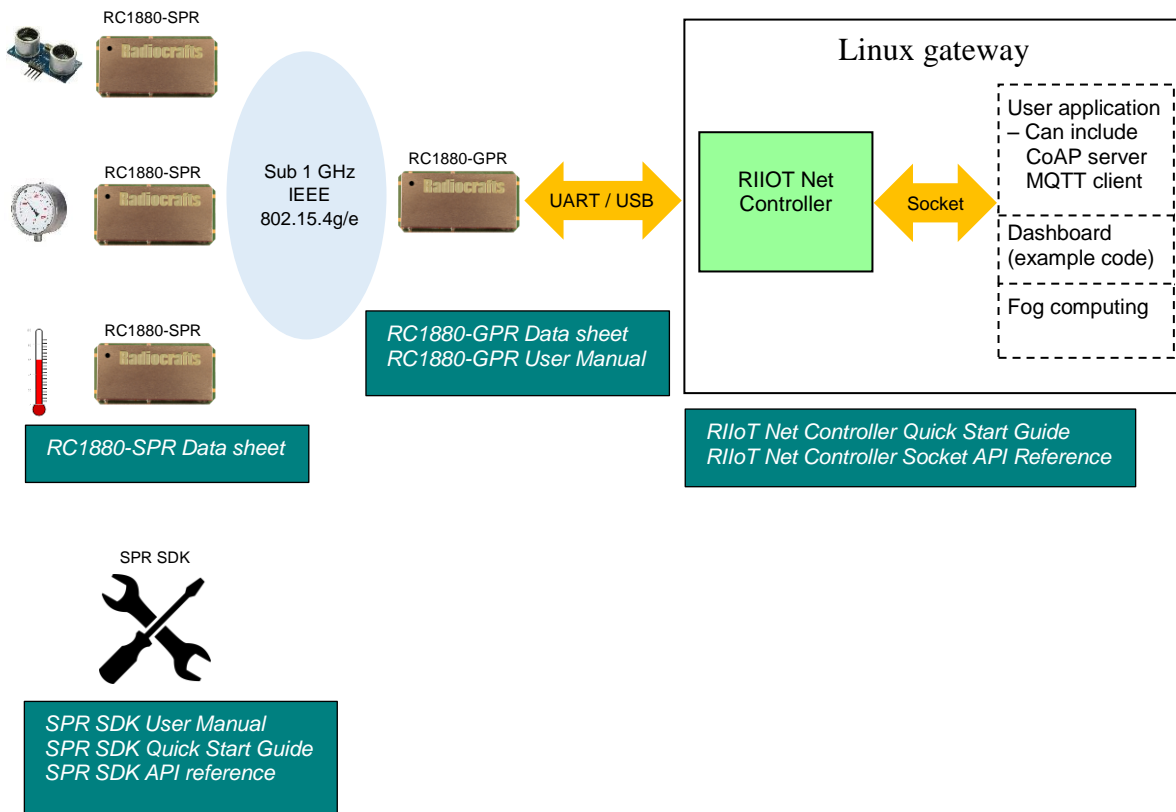

Figure 1. RIIoT network – system and documentation overview

### Use with Linux gateway (recommended)

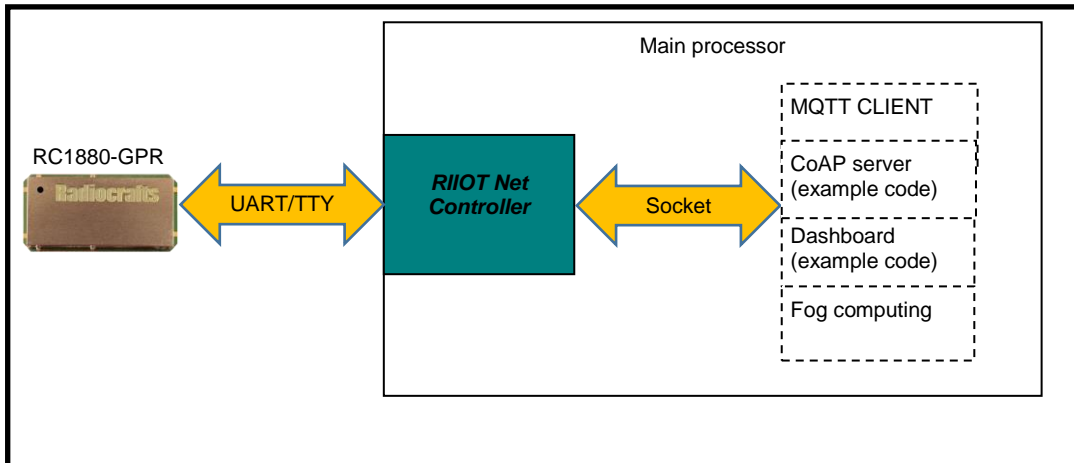

Figure 2. Gateway architecture

**Socket Interface:** The most common way to communicate with the GPR is indirect connection through the socket interface. Through the socket interface a high level API is available that allow the gateway application to do the following:

- Setup/configuring the network
- Access control (allow joining/whitelist)
- Set security policy for the network.
- Send and receive data to nodes though JSON objects

The *RIoT Net Controller* is an intelligent middleware that contains the following functionality

- Start and optionally stop the RIoT network
- Manage list of associated devices.
- Manage whitelist of pre-approved devices.
- Provide socket interface with high-level API for customer applications to access the network
- Handle serial port interface to RC1880-GPR

For more detailed info see the **RIoT Net Controller Quick Start** and **RIoT Net Controller Socket API Reference**.

### Use in non-Linux gateway

In a non-Linux gateway, the API through UART interface must be used to control the 802.15.4 stack directly. The details of this UART API is documented in the RC1880-GPR User Manual.

Below show some examples of commands that can be sent via the UART interface..

Command to RC1880-GPR	
<b>MAC_SCAN_REQ</b>	Optional to use. Can be used to scan available channels and determine if any IEEE802.15.4 compliant network is operational or to simply scan channels to find channel with less noise.
<b>MAC_START_REQ</b>	Starts the network. This command include important options like <ul style="list-style-type: none"> <li>- Band 868 MHz or 915 MHz</li> <li>- Frequency hopping or not.</li> <li>- Beacon or non beacon mode</li> <li>- Channel</li> <li>- PAN ID</li> <li>- Security settings</li> </ul>
<b>MAC_SET_REQ</b>	
<b>MAC_ASSOCIATE_RSP</b>	Based on the incoming <i>MAC_ASSOCIATE_IND</i> from RC1880-GPR the gateway can choose to send a confirmation that this device. The short address of the device is set by and stored on gateway
<b>MAC_DATA_REQ</b>	Command used to send data to a given device or to broadcast data.

Command from RC1880-GPR	
<b>MAC_SCAN_CNF</b>	Result of the scan request ( <i>MAC_SCAN_REQ</i> )
<b>MAC_ASSOCIATE_IND</b>	Indication that a device wants to join the network. Based on this incoming command the gateway can send a <i>MAC_ASSOCIATE_RSP</i> command to the module.
<b>MAC_DATA_CNF</b>	Confirmation that data sent to a specific device has been acknowledged.
<b>MAC_DATA_IND</b>	Incoming data from a node

### Pin Assignment

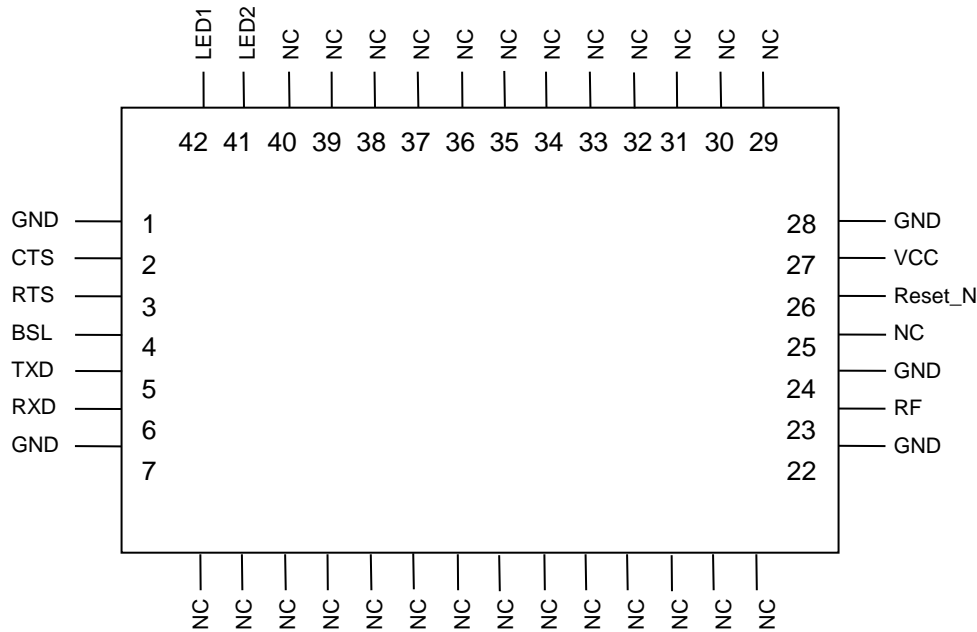

### Pin Description

Pin no	Pin name	Description
1	GND	System ground
2	CTS	UART flow control
3	RTS	UART flow control
4	BSL	Enable boot strap loader(Future Option)
5	TXD	Configurable I/O pin
6	RXD	Configurable I/O pin
7	GND	System ground
8-21	NC	Do not connect
22	GND	System ground
23	RF	RF I/O connection to antenna
24	GND	System ground
25	RX/TX	Not connected
26	RESET_N	Reset (Active low)
27	VCC	Supply voltage
28	GND	System ground
29-40	NC	Do not connect
41	LED2	Reserved for future use with network status LED. 4 mA source/sink capability
42	LED1	Reserved for future use with network status LED. 4 mA source/sink capability

Note 1: Pins 8 and 9 are suggested as I2C interface. They can be configured otherwise, but are connected to an optional internal EEPROM with I2C address = 000. It is recommended to leave these pins as I2C. Sensors and actuators or any other I2C device can be connected to these pins and accessed from the module.

### Regulatory Compliance Information

The use of RF frequencies and maximum allowed transmitted RF power is limited by national regulations. The RC1880 have been designed to comply with world wide regulations (RED directive 2014/53/EU in Europe, ARIB for Japan, G.S.R. 542(E)/45(E) for India, and FCC for the US). Final approval needs to be done with the end product embedded firmware.

### Mechanical Drawing

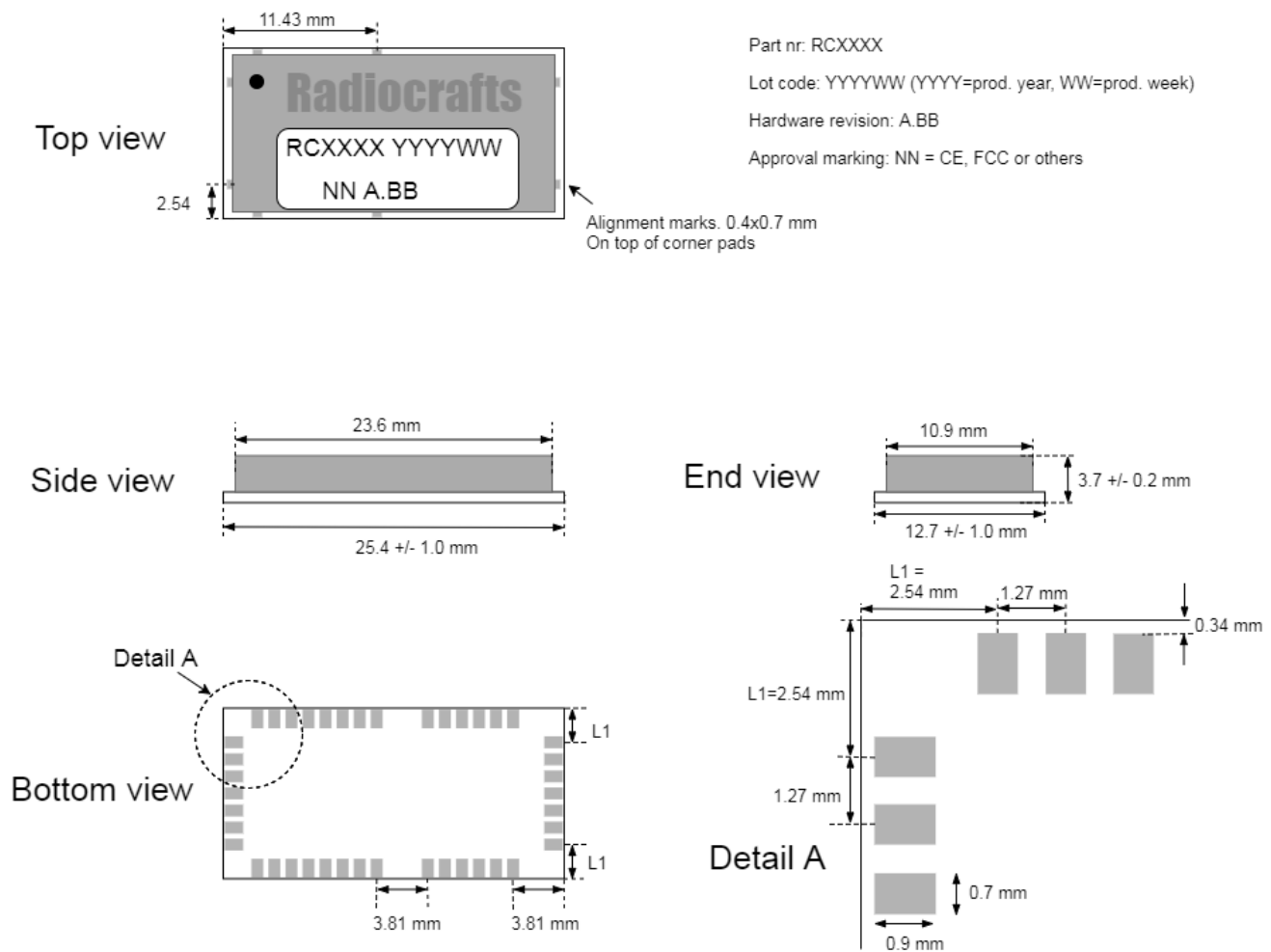

### Mechanical Dimensions

The module size is 12.7 x 25.4 x 3.7 mm.

### Carrier Tape and Reel Specification

Carrier tape and reel is in accordance with EIA Specification 481.

Tape width	Component pitch	Hole pitch	Reel diameter	Units per reel
44 mm	16 mm	4 mm	13"	Max 1000

### PCB Layout Recommendations

The recommended layout pads for the module are shown in the figure below.

The circle in upper left corner is an orientation mark only, and should not be a part of the copper pattern.

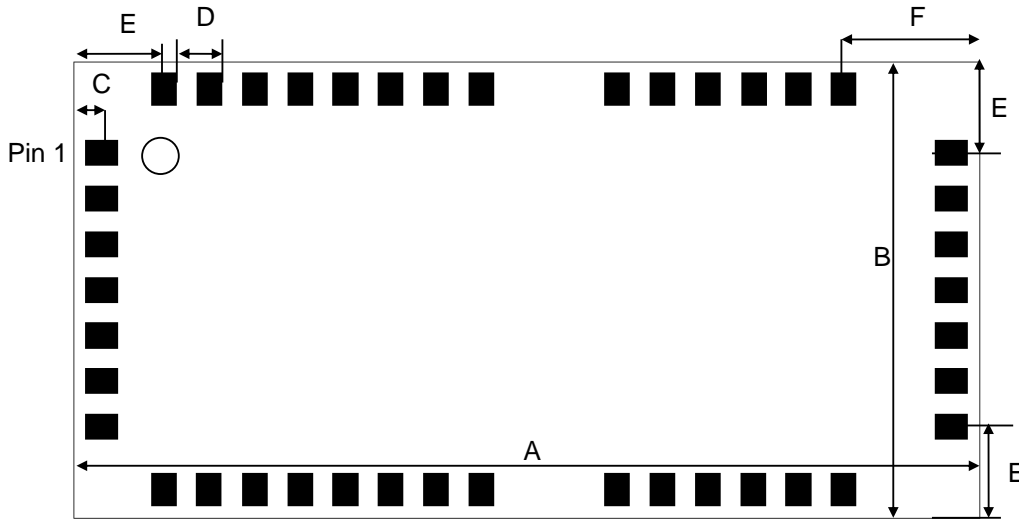

Dimention	Length [mm] (mil)	Comment
A	25.4 (1000)	Length of module
B	12.7 (500)	Width of module
C	0.79 (31)	Module edge vs centre of pad (Valid for all pads)
D	1.27 (50)	Pad to pad distance
E	2.54 (100)	Modul edge to pad (centre)
F	3.81 (150)	Modul edge to pad (centre)
G	0.9 (35.4)	Length of pad/recommend footprint pad
H	0.7 (27.6)	Width of pad/recommend footprint pad

Recommended pad design is shown below.

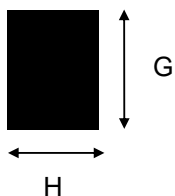

The recommended footprint for solder soldering is a one-to-one mapping between the LGA pad on module and the footprint.

For prototype build a solder hot plate is recommended. If the prototype is soldered manually by soldering iron, it is recommend to extend the pads of the footprint out from the module to make is accessible for a soldering iron.



A PCB with two or more layers and with a solid ground plane in one of the inner- or bottom layer(s) is recommended. All GND-pins of the module shall be connected to this ground plane with vias with shortest possible routing, one via per GND-pin.

Routing or vias under the module is not recommended as per IPC-recommendation. If any routing or vias is required under the module, the routing and vias must be covered with solder resist to prevent short circuiting of the test pads. It is recommended that vias are tented.

Reserved pins should be soldered to the pads, but the pads must be left floating electrically (no connection).

Note that Radiocrafts technical support team is available for free-of-charge schematic- and layout review of your design.

### Soldering Profile Recommendation

JEDEC standard IPC/JEDEC J-STD-020D.1 (page 7 and 8), Pb-Free Assembly is recommended.

The standard requires that the heat dissipated in the "surroundings" on the PCB is taken into account. The peak temperature should be adjusted so that it is within the window specified in the standard for the actual motherboard.

Aperture for paste stencil is normally areal-reduced by 20-35%, please consult your production facility for best experience aperture reduction. Nominal stencil thickness of 0.1-0.12 mm recommended.

### Absolute Maximum Ratings

Parameter	Min	Max	Unit
Supply voltage, VCC	-0.3	4.1	V
Voltage on any pin	-0.3	VCC + 0.3 (max 4.1)	V
Input RF level		10	dBm
Storage temperature	-40	150	°C
Operating temperature	-40	85	°C

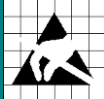

**Caution ! ESD sensitive device. Precaution should be used when handling the device in order to prevent permanent damage.**

Under no circumstances the absolute maximum ratings given above should be violated. Stress exceeding one or more of the limiting values may cause permanent damage to the device.

### Electrical Specifications

T=25°C, VCC = 3.3V, 868 MHz, 50 ohm if nothing else stated.

Parameter	Min	Typ.	Max	Unit	Condition / Note
Operating frequency	862		930	MHz	
Input/output impedance		50		Ohm	
Data rate		50		kbit/s	
Frequency stability			+/- 10 +/-15 +20/-26	ppm ppm ppm	Initially Temperature drift -30°-85° Temperature drift -40°-85° Other stability option available on request
Transmit power	-10		14	dBm	Programmable from firmware
Harmonics 2 <sup>nd</sup> harmonic 3 <sup>rd</sup> harmonic		-52 -58			@ max output power
Spurious emission, TX, 868 MHz 30 – 1000 MHz 30 – 1000 MHz 1-12.75 GHz			-59 -51 -37	dBm dBm dBm	EN 300 220 restricted band EN 300 220 un-restricted band
Spurious emission, TX, 915 MHz 30 – 88 MHz 88 – 960 MHz 960 – 2390 MHz 1-12.75 GHz		< -66 < -65 < -55 < -43			Within FCC restricted band Within FCC restricted band Within FCC restricted band Outside FCC restricted band

Sensitivity		-110		dBm	BER = 1%, 50 kbps 2 FSK, IEEE 802.15.4g mandatory settings
Saturation		10		dBm	
Spurious emission, RX 1-12.75 GHz		-70		dBm	Complies with EN 300 320 CRF47 Part 15 and ARIB STD-T66
Supply voltage Recommended operating voltage	1.8		3.8	V	
Current consumption, RX		6.2		mA	VCC = 3.6V
Current consumption, TX		26.5		mA	Output power 14 dBm, VCC = 3.6V
		19			Output power 12 dBm.
Current consumption, Shutdown Sleep, RTC based on Crystal		185 700		nA nA	
MCU clock frequency		48		MHz	
MCU low frequency crystal		32.768		kHz	Optional
Antenna VSWR		<2:1	3:1		
UART speed		115.2		kbaud	

### Product Status and Definitions

<i>Current Status</i>	<i>Data Sheet Identification</i>	<i>Product Status</i>	<i>Definition</i>
	Advance Information	Planned or under development	This data sheet contains the design specifications for product development. Specifications may change in any manner without notice.
	Preliminary	Engineering Samples and First Production	This data sheet contains preliminary data, and supplementary data will be published at a later date. Radiocrafts reserves the right to make changes at any time without notice in order to improve design and supply the best possible product.
X	No Identification Noted	Full Production	This data sheet contains final specifications. Radiocrafts reserves the right to make changes at any time without notice in order to improve design and supply the best possible product.
	Not recommended for new designs	Last time buy available	Product close to end of lifetime

	Obsolete	Not in Production Optionally accepting order with Minimum Order Quantity	This data sheet contains specifications on a product that has been discontinued by Radiocrafts. The data sheet is printed for reference information only.
--	----------	---	---

### Disclaimer

Radiocrafts AS believes the information contained herein is correct and accurate at the time of this printing. However, Radiocrafts AS reserves the right to make changes to this product without notice. Radiocrafts AS does not assume any responsibility for the use of the described product; neither does it convey any license under its patent rights, or the rights of others. The latest updates are available at the Radiocrafts website or by contacting Radiocrafts directly.

As far as possible, major changes of product specifications and functionality, will be stated in product specific Errata Notes published at the Radiocrafts website. Customers are encouraged to check regularly for the most recent updates on products and support tools.

### Trademarks

All trademarks, registered trademarks and product names are the sole property of their respective owners.

### Life Support Policy

This Radiocrafts product is not designed for use in life support appliances, devices, or other systems where malfunction can reasonably be expected to result in significant personal injury to the user, or as a critical component in any life support device or system whose failure to perform can be reasonably expected to cause the failure of the life support device or system, or to affect its safety or effectiveness. Radiocrafts AS customers using or selling these products for use in such applications do so at their own risk and agree to fully indemnify Radiocrafts AS for any damages resulting from any improper use or sale.

### Radiocrafts Technical Support

Knowledge base: <https://radiocrafts.com/knowledge-base/>  
Application notes library: <https://radiocrafts.com/resources/application-notes/>  
Whitepapers: <https://radiocrafts.com/resources/articles-white-papers/>  
Technology overview: <https://radiocrafts.com/technologies/>  
RF Wireless Expert Training: <https://radiocrafts.com/resources/rf-wireless-expert-training/>

### Contact Information

Web site: [www.radiocrafts.com](http://www.radiocrafts.com)  
Email: [radiocrafts@radiocrafts.com](mailto:radiocrafts@radiocrafts.com)

Address:  
Radiocrafts AS  
Sandakerveien 64  
NO-0484 OSLO  
NORWAY

Tel: +47 4000 5195  
Fax: +47 22 71 29 15  
E-mail: [sales@radiocrafts.com](mailto:sales@radiocrafts.com)

© 2018, Radiocrafts AS. All rights reserved.