

CARRIER TAPE SPEC FOR SMT SINGLE VERTICAL HEADER OF NANO-FIT					
CARRIER TAPE NUMBER	DIM A	DIM B	DIM D	DIM E	DIM F
105431-8001	24.00	N/A	11.50	8.63	6.97
105431-8002	24.00	N/A	11.50	11.13	9.47
105431-8003	32.00	28.40	14.20	13.63	11.97
105431-8004	32.00	28.40	14.20	16.13	14.47
105431-8005	44.00	40.40	20.20	18.63	16.97
105431-8006	44.00	40.40	20.20	21.13	19.47
105431-8007	44.00	40.40	20.20	23.63	21.97

NOTES :
1. REELING DIRECTION IN DELIVERY.

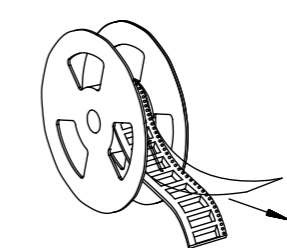

USER FEEDING DIRECTION



SECTION B-B

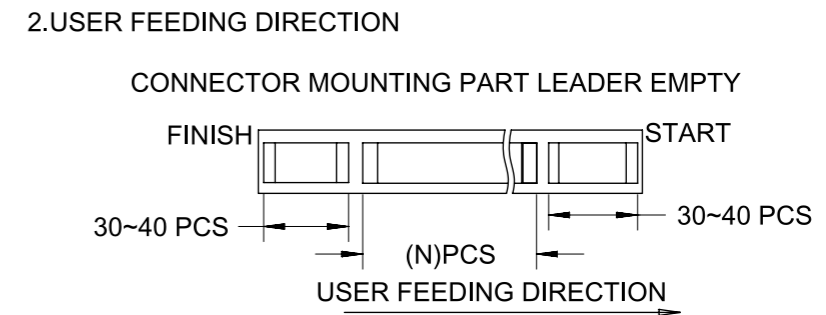

3. COVER TAPE PEELING FORCE
PEELING SPEED 300mm/Min.(REF.)

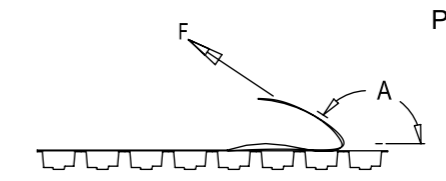

A	170°~180°
F	0.1N~1.3N

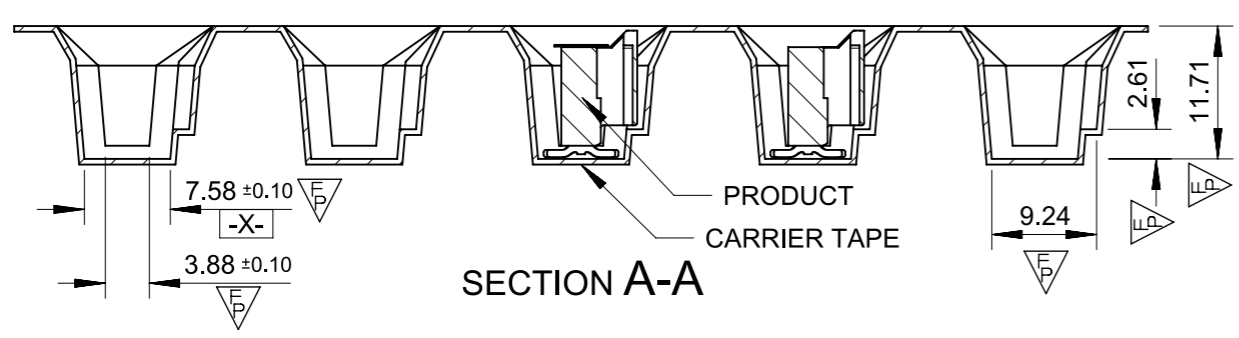

SECTION A-A

USER FEEDING DIRECTION

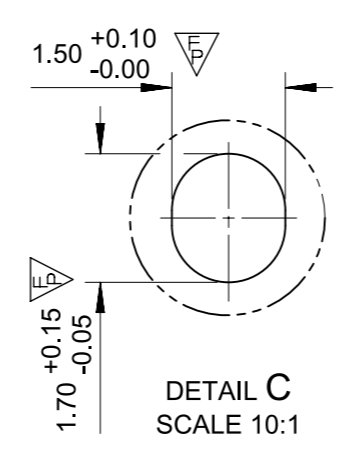

DETAIL C
SCALE 10:1

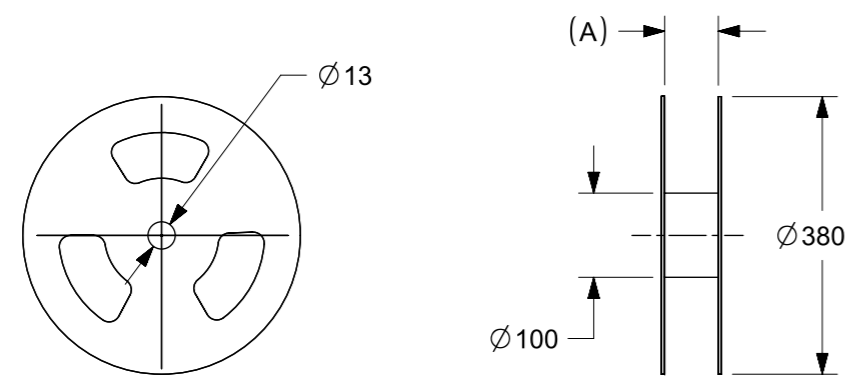
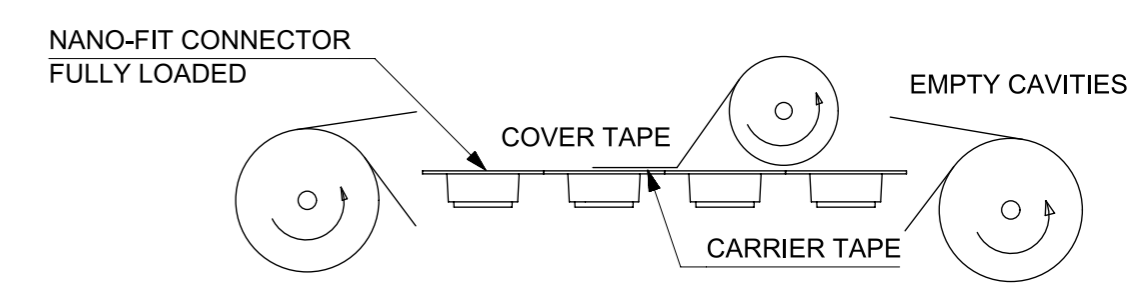

FUNCTIONAL SYMBOLS	THIS DRAWING CONTAINS INFORMATION THAT IS PROPRIETARY TO MOLEX ELECTRONIC TECHNOLOGIES, LLC AND SHOULD NOT BE USED WITHOUT WRITTEN PERMISSION		CURRENT REV DESC:		molex	
GENERAL TOLERANCES (UNLESS SPECIFIED)	mm	SCALE	1:1			
ANGULAR TOL	±	°			PACKING DRAWING FOR NANO-FIT	
4 PLACES	±				PRODUCT CUSTOMER DRAWING	
3 PLACES	±				DOCUMENT NUMBER	
2 PLACES	±	0.13			1054311000-PK	
1 PLACE	±	0.25			DOC TYPE	
0 PLACES	±				PSD	
DRAFT WHERE APPLICABLE MUST REMAIN WITHIN DIMENSIONS	THIRD ANGLE PROJECTION		DRAWING	SERIES	MATERIAL NUMBER	CUSTOMER
	A3-SIZE		105431	GENERAL MARKET	SHEET NUMBER	
					1 OF 2	



REEL	COVER TAPE	CARRIER TAPE	PRODUCT NUMBER		PARTS PER REEL	REELS PER CARTON	PARTS PER CARTON	
885961399	894990121	105431-8001	WITH MYLAR	105431-1102, 105431-1202, 105431-1302, 105431-1402	300	3	900	
			WITHOUT MYLAR	105431-1502, 105431-1602, 105431-1702, 105431-1802				
			WITHOUT MYLAR	105431-2502, 105431-2602, 105431-2702, 105431-2802				
		105431-8002	WITH MYLAR	105431-1103, 105431-1203, 105431-1303, 105431-1403				
			WITHOUT MYLAR	105431-2103, 105431-2203, 105431-2303, 105431-2403				
			WITHOUT MYLAR	105431-1503, 105431-1603, 105431-1703, 105431-1803				
885961400	894990122	105431-8003	WITH MYLAR	105431-1104, 105431-1204, 105431-1304, 105431-1404	300	3	900	
			WITHOUT MYLAR	105431-2104, 105431-2204, 105431-2304, 105431-2404				
			WITHOUT MYLAR	105431-1504, 105431-1604, 105431-1704, 105431-1804				
		105431-8004	WITH MYLAR	105431-1105, 105431-1205, 105431-1305, 105431-1405				
			WITHOUT MYLAR	105431-2105, 105431-2205, 105431-2305, 105431-2405				
			WITHOUT MYLAR	105431-1505, 105431-1605, 105431-1705, 105431-1805				
885961401	894990123	105431-8005	WITH MYLAR	105431-1106, 105431-1206, 105431-1306, 105431-1406	300	2	600	
			WITHOUT MYLAR	105431-2106, 105431-2206, 105431-2306, 105431-2406				
			WITHOUT MYLAR	105431-1506, 105431-1606, 105431-1706, 105431-1806				
			105431-8006	WITH MYLAR				105431-1107, 105431-1207, 105431-1307, 105431-1407
				WITHOUT MYLAR				105431-2107, 105431-2207, 105431-2307, 105431-2407
				WITHOUT MYLAR				105431-1507, 105431-1607, 105431-1707, 105431-1807
		105431-8007	WITH MYLAR	105431-1108, 105431-1208, 105431-1308, 105431-1408	300	2	600	
			WITHOUT MYLAR	105431-2108, 105431-2208, 105431-2308, 105431-2408				
			WITHOUT MYLAR	105431-1508, 105431-1608, 105431-1708, 105431-1808				
			WITHOUT MYLAR	105431-2508, 105431-2608, 105431-2708, 105431-2808				
			WITHOUT MYLAR	105431-2508, 105431-2608, 105431-2708, 105431-2808				
			WITHOUT MYLAR	105431-2508, 105431-2608, 105431-2708, 105431-2808				

- NOTES :
1. STAPLES SHOULD ONLY BE USED TO SET UP CARTON. ALL CARTONS CLOSURES MUST BE DONE WITH TAPE.
 2. FILL PACKAGING BAGS WITH THE QUANTITIES AS INDICATED IN THE CHART



FUNCTIONAL SYMBOLS		THIS DRAWING CONTAINS INFORMATION THAT IS PROPRIETARY TO MOLEX ELECTRONIC TECHNOLOGIES, LLC AND SHOULD NOT BE USED WITHOUT WRITTEN PERMISSION		CURRENT REV DESC:		molex	
▽/A = 0	mm	SCALE	1:1	EC NO: 670810			
▽/E = 0	GENERAL TOLERANCES (UNLESS SPECIFIED)			DRWN: GLLI		2021/07/21	
▽/P = 0	ANGULAR TOL ± °			CHK'D: YXZHENG		2021/07/22	
DIVISIONAL SYMBOLS		4 PLACES ±		APPR: YXZHENG		2021/07/22	
		3 PLACES ±		INITIAL REVISION:		DOCUMENT NUMBER	
		2 PLACES ± 0.13		DRWN: GLLI		1054311000-PK	
		1 PLACE ± 0.25		APPR: YXZHENG		PSD 000 A	
		0 PLACES ±		2021/07/21		2021/07/22	
DRAFT WHERE APPLICABLE MUST REMAIN WITHIN DIMENSIONS		THIRD ANGLE PROJECTION		DRAWING		SERIES	
		A3-SIZE		105431		MATERIAL NUMBER	
				CUSTOMER		GENERAL MARKET	
						SHEET NUMBER	
						2 OF 2	

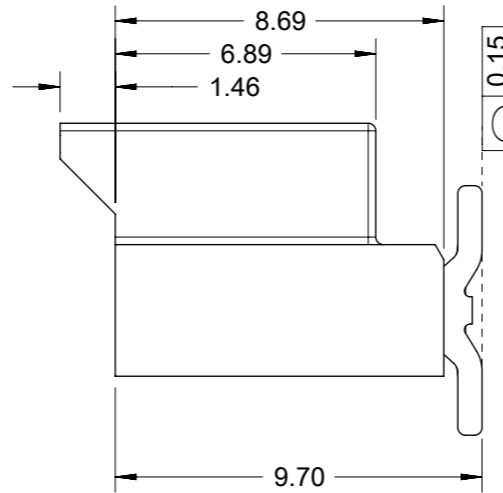

RECOMMENDED PCB LAYOUT(CONNECTOR SIDE VIEW)
THICKNESS=1.60mm MIN. TOLERANCE:±0.05



WITHOUT MYLAR



WITH MYLAR

THIS DRAWING CONTAINS INFORMATION THAT IS PROPRIETARY TO MOLEX ELECTRONIC TECHNOLOGIES, LLC AND SHOULD NOT BE USED WITHOUT WRITTEN PERMISSION											
QUALITY SYMBOLS ▽A = 0 ▽E = 0 ▽F = 0 ▼ = 0 ▽C = 0 ⊠ = 0 ■ = 0 ▽ = 0	2021/04/27	2021/07/22	2021/07/22	GENERAL TOLERANCES (UNLESS SPECIFIED)		DIMENSION UNITS	SCALE	molex			
	DRWN: GLLI	CHK'D: YXZHENG	APPR: YXZHENG	ANGULAR TOL ± 3.0 °		mm	5:1				
	EC NO: 670810 DRWN: GLLI CHK'D: YXZHENG APPR: YXZHENG	4 PLACES	±	4 PLACES ±		DRWN BY	DATE	SD DRAWING FOR NANO-FIT HEADER OF SMT VERTICAL SINGLE CONN.			
		3 PLACES	±	3 PLACES ±		WJHUO	2014/10/30				
		2 PLACES	± 0.2	2 PLACES ± 0.2		CHK'D BY	DATE	PRODUCT CUSTOMER DRAWING			
		1 PLACE	± 0.3	1 PLACE ± 0.3		AYIN	2015/03/12				
		0 PLACES	±	0 PLACES ±		APPR BY	DATE	SERIES	MATERIAL NUMBER	CUSTOMER	
	DRAFT WHERE APPLICABLE MUST REMAIN WITHIN DIMENSIONS				DRAWING SIZE	THIRD ANGLE PROJECTION	A3	105431	SEE TABLE	GENERAL MARKET	
					DOCUMENT NUMBER	DOC TYPE	DOC PART	SHEET NUMBER			
					D1	REV		SD-105431-001	PSD	000	1 OF 4

9		8			7		6		5		4		3			2		1	
PART NUMBER (WITH MYLAR)	PART NUMBER (WITHOUT MYLAR)	DIM. A	DIM. B	DIM. C	CKT SIZE	PLATING	LUBE					PART NUMBER (WITH MYLAR)	PART NUMBER (WITHOUT MYLAR)	DIM. A	DIM. B	DIM. C	CKT SIZE	PLATING	LUBE
105431-1102	105431-1502	8.23	2.50	6.11	2	TIN						105431-2102	105431-2502	8.23	2.50	6.11	2	TIN	
105431-1103	105431-1503	10.73	5.00	8.61	3							105431-2103	105431-2503	10.73	5.00	8.61	3		
105431-1104	105431-1504	13.23	7.50	11.11	4							105431-2104	105431-2504	13.23	7.50	11.11	4		
105431-1105	105431-1505	15.73	10.00	13.61	5							105431-2105	105431-2505	15.73	10.00	13.61	5		
105431-1106	105431-1506	18.23	12.50	16.11	6							105431-2106	105431-2506	18.23	12.50	16.11	6		
105431-1107	105431-1507	20.73	15.00	18.61	7							105431-2107	105431-2507	20.73	15.00	18.61	7		
105431-1108	105431-1508	23.23	17.50	21.11	8							105431-2108	105431-2508	23.23	17.50	21.11	8		
105431-1202	105431-1602	8.23	2.50	6.11	2							GOLD 0.38	NO						
105431-1203	105431-1603	10.73	5.00	8.61	3	105431-2203	105431-2603	10.73	5.00	8.61	3								
105431-1204	105431-1604	13.23	7.50	11.11	4	105431-2204	105431-2604	13.23	7.50	11.11	4								
105431-1205	105431-1605	15.73	10.00	13.61	5	105431-2205	105431-2605	15.73	10.00	13.61	5								
105431-1206	105431-1606	18.23	12.50	16.11	6	105431-2206	105431-2606	18.23	12.50	16.11	6								
105431-1207	105431-1607	20.73	15.00	18.61	7	105431-2207	105431-2607	20.73	15.00	18.61	7								
105431-1208	105431-1608	23.23	17.50	21.11	8	105431-2208	105431-2608	23.23	17.50	21.11	8								
105431-1302	105431-1702	8.23	2.50	6.11	2	GOLD 0.76												105431-2302	105431-2702
105431-1303	105431-1703	10.73	5.00	8.61	3							105431-2303	105431-2703	10.73	5.00	8.61	3		
105431-1304	105431-1704	13.23	7.50	11.11	4							105431-2304	105431-2704	13.23	7.50	11.11	4		
105431-1305	105431-1705	15.73	10.00	13.61	5							105431-2305	105431-2705	15.73	10.00	13.61	5		
105431-1306	105431-1706	18.23	12.50	16.11	6							105431-2306	105431-2706	18.23	12.50	16.11	6		
105431-1307	105431-1707	20.73	15.00	18.61	7							105431-2307	105431-2707	20.73	15.00	18.61	7		
105431-1308	105431-1708	23.23	17.50	21.11	8							105431-2308	105431-2708	23.23	17.50	21.11	8		
105431-1402	105431-1802	8.23	2.50	6.11	2							GOLD 0.76	YES					105431-2402	105431-2802
105431-1403	105431-1803	10.73	5.00	8.61	3	105431-2403	105431-2803	10.73	5.00	8.61	3								
105431-1404	105431-1804	13.23	7.50	11.11	4	105431-2404	105431-2804	13.23	7.50	11.11	4								
105431-1405	105431-1805	15.73	10.00	13.61	5	105431-2405	105431-2805	15.73	10.00	13.61	5								
105431-1406	105431-1806	18.23	12.50	16.11	6	105431-2406	105431-2806	18.23	12.50	16.11	6								
105431-1407	105431-1807	20.73	15.00	18.61	7	105431-2407	105431-2807	20.73	15.00	18.61	7								
105431-1408	105431-1808	23.23	17.50	21.11	8	105431-2408	105431-2808	23.23	17.50	21.11	8								

COLOR: BLACK

COLOR: NATURAL







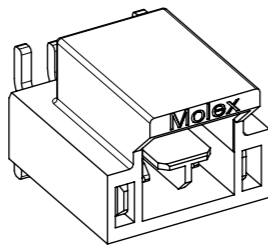
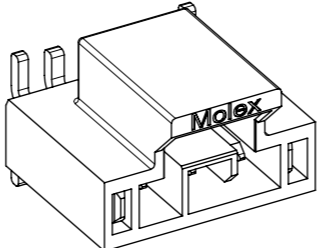
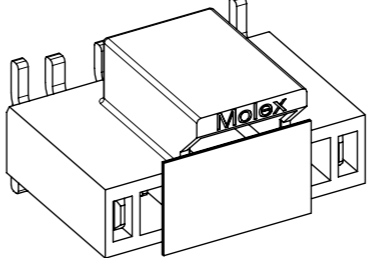
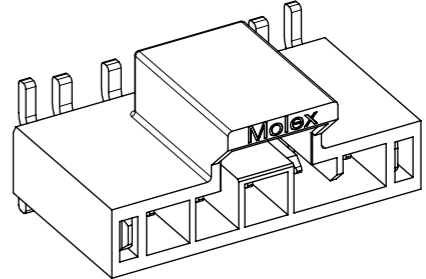
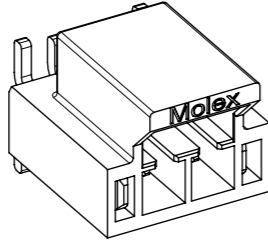
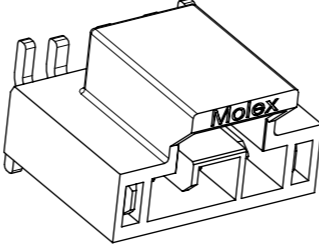
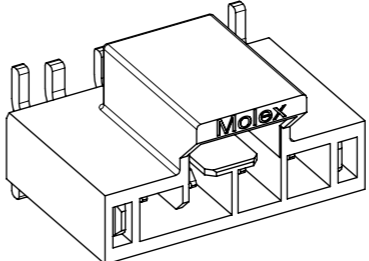
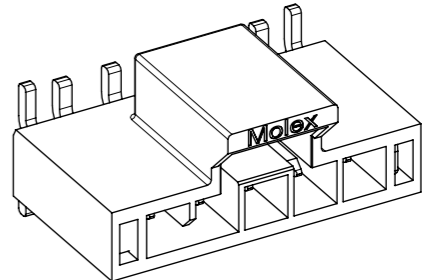
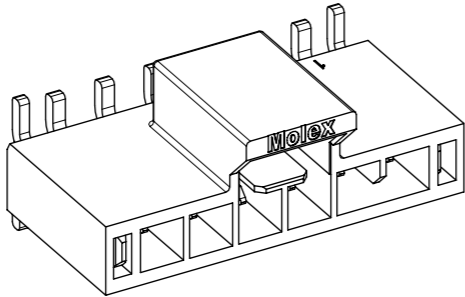
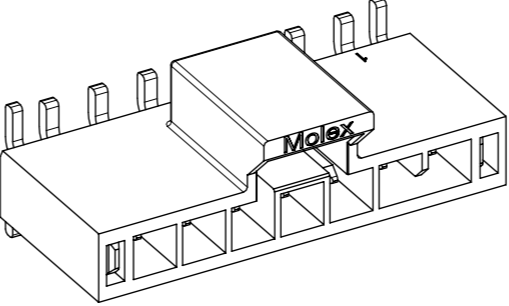
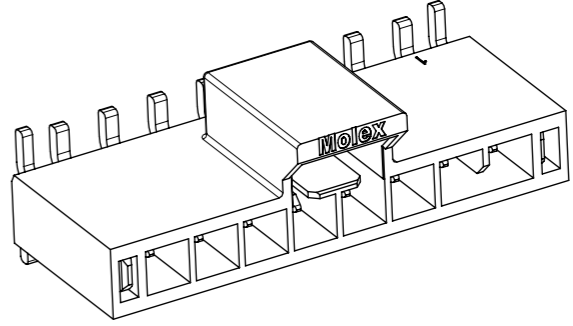
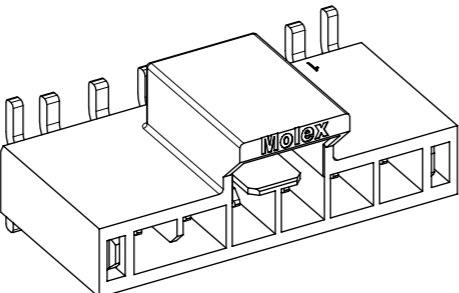
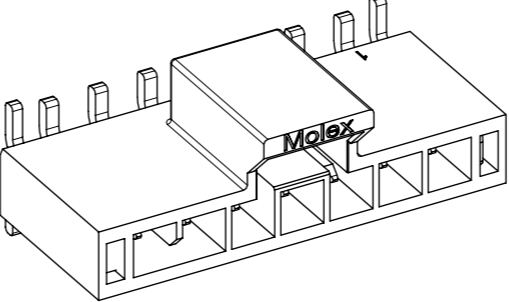
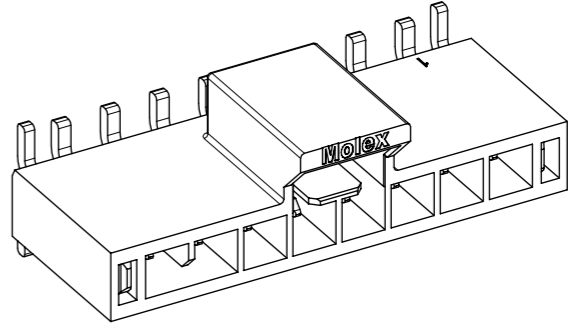

NOTES FOR ALL PARTS

1> MATERIAL:
HOUSING: LCP, UL 94V-0.
TERMINAL: BRASS.
SOLDER CLIP: BRASS.
2> PLATING FINISHED:
TERMINAL:
CONTACT AREA:
a. REFLOWED MATTE TIN 0.76 MICRONS MIN; b. GOLD 0.38 MICRONS MIN; c. GOLD 0.76 MICRONS MIN.
SOLDER AREA: TIN 0.76 MICRONS MINIMUM.
UNDER PLATING NICKEL 1.25 MICRONS MINIMUM.
SOLDER CLIP: TIN 2.5 MICRONS MINIMUM; UNDER PLATING NICKEL 1.25 MICRONS MINIMUM.

3> PRODUCT SPECIFICATION: PS-105405-001.
4> PACKAGE: TAPE REEL, DETAILS REFER TO DRAWING 1054311000-PK.
5> ALL COMPONENTS AND PRODUCT COMPLIANT TO RoHS DIRECTIVE 2011/65/EU AND ELV DIRECTIVE 2000/53/EC.
6> PRODUCT MATE WITH SERIES OF 105307(RECEPTACLE), 105300(CRIMP TERMINAL).
7> PARTS CONFORM TO CLASS 'B' REQUIREMENTS OF COSMETIC SPECIFICATION PS-45499-002.

QUALITY SYMBOLS ▽A = 0 ▽E = 0 ▽B = 0 ▼ = 0 ▽C = 0 ⊗ = 0 ■ = 0 ▽ = 0	THIS DRAWING CONTAINS INFORMATION THAT IS PROPRIETARY TO MOLEX ELECTRONIC TECHNOLOGIES, LLC AND SHOULD NOT BE USED WITHOUT WRITTEN PERMISSION										
	EC NO: 670810 DRWN: GLLI CHK'D: YXZHENG APPR: YXZHENG	GENERAL TOLERANCES (UNLESS SPECIFIED) ANGULAR TOL ± 3.0 °		DIMENSION UNITS: mm SCALE: 5:1		 SD DRAWING FOR NANO-FIT HEADER OF SMT VERTICAL SINGLE CONN.					
		4 PLACES ± 3 PLACES ± 2 PLACES ± 0.2 1 PLACE ± 0.3 0 PLACES ±		DRWN BY: WJHUO DATE: 2014/10/30 CHK'D BY: DATE:							
		DRAFT WHERE APPLICABLE MUST REMAIN WITHIN DIMENSIONS		DRAWING SIZE: A3 THIRD ANGLE PROJECTION		PRODUCT CUSTOMER DRAWING					
RELEASE STATUS: P1 RELEASE DATE: 2021/07/22 09:31:37		SERIES: 105431 MATERIAL NUMBER: SEE TABLE CUSTOMER: GENERAL MARKET		DOCUMENT NUMBER: SD-105431-001 DOC TYPE: PSD DOC PART: 000 SHEET NUMBER: 3 OF 4							

	2 CKT	3 CKT	4 CKT	5 CKT
BLACK				
NATURAL				
	6 CKT	7 CKT	8 CKT	
BLACK				
NATURAL				

THIS DRAWING CONTAINS INFORMATION THAT IS PROPRIETARY TO MOLEX ELECTRONIC TECHNOLOGIES, LLC AND SHOULD NOT BE USED WITHOUT WRITTEN PERMISSION													
QUALITY SYMBOLS  = 0  = 0  = 0  = 0  = 0  = 0  = 0		EC NO: 670810 DRWN: GLLI CHK'D: YXZHENG APPR: YXZHENG		2021/04/27 2021/07/22 2021/07/22		GENERAL TOLERANCES (UNLESS SPECIFIED) ANGULAR TOL ± 3.0 ° 4 PLACES ± 3 PLACES ± 2 PLACES ± 0.2 1 PLACE ± 0.3 0 PLACES ±		DRAFT WHERE APPLICABLE MUST REMAIN WITHIN DIMENSIONS		DIMENSION UNITS: mm SCALE: 3:1 DRWN BY: RMV02 DATE: 2016/01/14 CHK'D BY: DATE: APPR BY: AYIN DATE: 2017/05/15		 SD DRAWING FOR NANO-FIT HEADER OF SMT VERTICAL SINGLE CONN.	
PRODUCT CUSTOMER DRAWING		SERIES: 105431 MATERIAL NUMBER: CUSTOMER: GENERAL MARKET		DRAWING SIZE: A3 THIRD ANGLE PROJECTION: 		DOCUMENT NUMBER: SD-105431-001 DOC TYPE: PSD DOC PART: 000 SHEET NUMBER: 4 OF 4							