

SUMMARY



Image is for illustrative purpose only

Wires

Low voltage 3

Series	2K
Termination type	Male solder
IP rating	68 when mated
AWG wire size	24.00 - 16.00
Cable Ø	0.00 - 0.00 mm
Status	active
Matching parts	PHG.2K.303.CLLC50

Download

[Request a quote](#)

[Catalog](#)

TECHNICAL DETAILS

Mechanics

Shell Style/Model	FA*: Fixed plug, non-latching, nut fixing
Keying	1 key (alpha=0, plug: male contacts, receptacle: female contacts)
Housing Material	Brass (chrome plated [SAE AMS 2460]) shell, collet nut and latch sleeve, nickel plated [SAE AMS QQ N 290] brass mid pieces
Weight	40.82 g

Performance

Configuration	2K.303 : 3 Low Voltage
Insulator	L: PEEK (UL 94 / V-0/1.5)
Rated Current	17 Amps

Specifications

Contact Type: Solder
Contact Dia.: 1.6 mm (0.063in)
Bucket Dia.: 1.4 mm (0.055in)
Max. Solid Conductor: 1 mm² (AWG 16)
Max. Stranded Conductor: 1 mm² (AWG 18)
R (max): 3.5 mOhm
Vtest (contact-shell): 1850 V (AC), 2600 V (DC)
Vtest (contact-contact): 2400 V (AC), 3390 V (DC)

LEMO products and services are provided "as is". LEMO makes no warranties or representations with regard to LEMO product & services or use of them, express, implied or statutory, including for accuracy, completeness, or security. The user is fully responsible for his products and applications using LEMO components.

Others

Endurance (Shell): 5000 mating cycles
 Temp (min / max): -55°C / +200°C
 Humidity (max): <=95% [at 60 deg C / 140 F]
 Vibration: 15 g [10 Hz - 2000 Hz]
 Shock Resistance: 100 g [6 ms]
 Climatical Category: 50/175/21
 Shielding (min): 95 dB (10 MHz)
 Shielding (min): 80 dB (1 GHz)
 Salt Spray Corrosion: >1000 hr

DRAWINGS

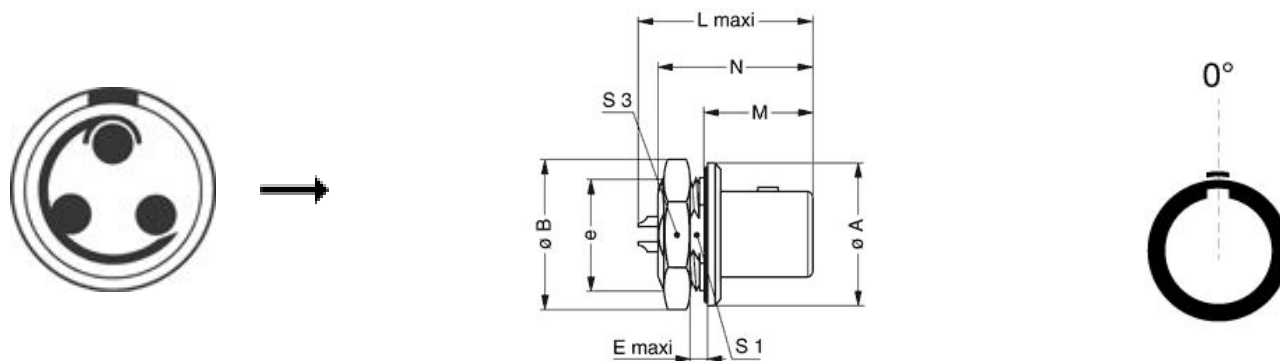

Dimensions





















	A	B	E	L	M	N	S1	S3	e
mm.	25	27.5	4.5	33.6	18	28.3	18.5	24	M20x1.0
in.	0,98	1,08	0,18	1,32	0,71	1,11	0,73	0,94	

RECOMMENDED BY LEMO

Tools

LEMO products and services are provided "as is". LEMO makes no warranties or representations with regard to LEMO product & services or use of them, express, implied or statutory, including for accuracy, completeness, or security. The user is fully responsible for his products and applications using LEMO components.

Cables

CMN.03.T18.055PGZE		Grey	
CMN.03.T18.055PNZE			
CMN.03.T18.055QGZE	TPR (medical)	Grey	
CMN.03.T20.049PGZE		Grey	
CMN.03.T20.049PNZE			
CMN.03.T28.031PGCE	PVC	GREY	
CMN.03.T28.031PGZE		Grey	
CMN.03.T28.031PNCE	PVC	Black	
CMN.03.T28.031PNZE			
130240	PVC	Black	
130250	PVC	Grey	
230500	PVC	Grey	
230750	PVC	Grey	
30110	PVC	Grey	
30141	PVC	Grey	
30260	PVC	Black	
3041	PVC	Grey	
3050	PVC	Black	
3081	PVC	Black	
3220	PVC	Black	
3280	PVC	Black	
60080	PVC	Grey	

LEMO products and services are provided "as is". LEMO makes no warranties or representations with regard to LEMO product & services or use of them, express, implied or statutory, including for accuracy, completeness, or security. The user is fully responsible for his products and applications using LEMO components.