

MAX2678

GPS/GNSS Front-End Amplifier

General Description

The MAX2678 GPS/GNSS front-end amplifier IC is designed for automotive and marine GPS/GNSS satellite navigation antenna modules, or for any application that needs to compensate for cable losses from the antenna to receiver. Two unconditionally stable low-noise amplifier stages provide the high gain and integrated I/O matching to minimize the need for external matching components and eliminate the need for additional gain stages. The IC features the option to place a bandpass ceramic or surface acoustic wave (SAW) filter between the two amplifier stages for improved immunity to out-of-band interferers. Additionally, a 3.4dB-gain step is provided to compensate for cable loss variation between different applications.

The device is designed to operate across all GNSS frequency standards with a 35dB typical cascaded gain and a 25mA supply current. The two LNA stages allow the use of a wide range of GNSS filter types for maximum flexibility in system design. The final RF output pin, which drives the cable to the GNSS receiver, is also the power-supply connection that accepts a DC supply in the 3.0V to 5.25V range. Alternatively, the DC supply can be applied to pin 4.

This GPS/GNSS front-end amplifier is available in a lead-free, 10-pin TDFN surface-mount package (3mm x 3mm). Electrical performance is guaranteed over the extended -40°C to +105°C temperature range.

Functional Diagram

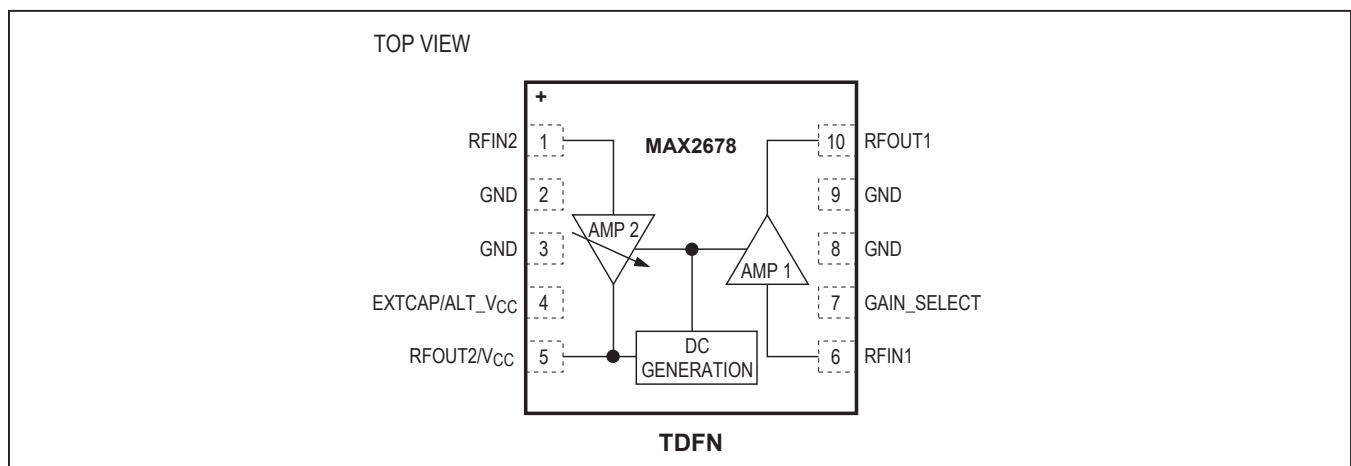

Features

- First Amplifier Noise Figure: 0.9dB
- High Gain:* 35dB
- 3.4dB Gain Step
- Shared V_{CC} and RFOUT2 Pin
- Integrated 50Ω Output Matching
- AMP 2 includes 50Ω Input Matching
- 3.0V to 5.25V Supply Voltage Range
- Small (3mm x 3mm) Low-Cost Package
- AEC-Q100 Qualified
- ESD Protected to ±2kV Human Body Model
- -40°C to +105°C Ambient Temperature Range

Applications

- Integrated Automotive and Marine GPS Receivers
- Active Antennas

*First amplifier input is impedance matched ($S_{11} = -10\text{dB}$).

Second amplifier is set to high gain. Amplifiers are cascaded without interstage filter.

[Ordering Information](#) and [Typical Operating Circuit](#) appear at end of data sheet.

Absolute Maximum Ratings

RFOUT2/V _{CC} , EXTCAP/ALT_V _{CC} , V _{CC} to GND.....-0.3V to +5.5V	Multi-Layer Board (derate 24.4mW/°C above +70°C) 1951mW
GAIN_SELECT, RFOUT1 to GND-0.3V to (V _{CC} + 0.25V, but ≤ 5.5V)	Operating Ambient Temperature Range..... -40°C to +105°C
RFIN1, RFIN2 Input Power (50Ω source).....+15dBm	Maximum Junction Temperature +150°C
RFIN1, RFIN2 to GND-0.3V to +1V	Storage Temperature Range -65°C to +150°C
Continuous Power Dissipation (T _A = +70°C)	Lead Temperature (soldering, 10s) +300°C
Single-Layer Board	Soldering Temperature (reflow) +260°C
(derate 18.5mW/°C above +70°C) 1481mW	

Stresses beyond those listed under "Absolute Maximum Ratings" may cause permanent damage to the device. These are stress ratings only, and functional operation of the device at these or any other conditions beyond those indicated in the operational sections of the specifications is not implied. Exposure to absolute maximum rating conditions for extended periods may affect device reliability.

Package Thermal Characteristics (Note 1)

Thermal Resistance, Single-Layer Board:	Thermal Resistance, Four-Layer Board:
Junction-to-Ambient (θ _{JA}).....54°C/W	Junction-to-Ambient (θ _{JA}).....41°C/W
Junction-to-Case Thermal Resistance (θ _{JC}).....9°C/W	Junction-to-Case Thermal Resistance (θ _{JC}).....9°C/W

Note 1: Package thermal resistances were obtained using the method described in JEDEC specification JESD51-7, using a four-layer board. For detailed information on package thermal considerations, refer to www.maximintegrated.com/thermal-tutorial.

DC Electrical Characteristics

(V_{IN} = 3.0V to 5.25V, T_A = -40°C to +105°C. Typical values are at +5.0V and at T_A = +25°C. Pin 7 is open, unless otherwise noted.) (Note 2)

PARAMETER	SYMBOL	CONDITIONS	MIN	TYP	MAX	UNITS
Supply Voltage	V _{CC}		3.0		5.25	V
Supply Current	I _{CC}	T _A = +25°C	15.0	25	32	mA
		T _A = -40°C to +105°C			35	
Gain-Select Input Current	I _{IL}	V _{IL} = 0V		20	100	μA

AC Electrical Characteristics

(V_{CC} = 3.0V to 5.25V, P_{IN} = -40dBm, f_{IN} = 1575MHz, T_A = -40°C to +105°C. Typical values are at 5.0V and at T_A = +25°C. AMP 1 input matched to 50Ω. All ports terminated in 50Ω. Pin 7 is open, unless otherwise noted.) (Note 2)

PARAMETER	SYMBOL	CONDITIONS	MIN	TYP	MAX	UNITS
Operating Frequency	f _{RF}			1575		MHz
AMP 1 Gain	S ₂₁ ₁		14	17	20	dB
AMP 1 Gain Variation Over Temperature				0.3		dB
AMP 1 Noise Figure	NF ₁			0.9		dB
AMP 1 Input Third-Order Intercept Point	IIP3	Two tones at 1574.5MHz and 1575.5MHz, -35dBm per tone		-12		dBm
AMP 1 Input 1dB Compression Point				-18		dBm
AMP 1 Input Return Loss	S ₁₁ ₁			-9		dB
AMP 1 Output Return Loss	S ₂₂ ₁			-15		dB
AMP 1 Reverse Isolation	S ₁₂ ₁			-33		dB
AMP 2 Gain	S ₂₁ ₂		14.5	18	22	dB
AMP 2 Gain Step		Gain change when pin 7 is shorted to GND	-2	-3.4	-6	dB

AC Electrical Characteristics (continued)

(V_{CC} = 3.0V to 5.25V, P_{IN} = -40dBm, f_{IN} = 1575MHz, T_A = -40°C to +105°C. Typical values are at 5.0V and at T_A = +25°C. Input matched to 50Ω, load = 50Ω, pin 7 is open, unless otherwise noted.) (Note 2)

PARAMETER	SYMBOL	CONDITIONS	MIN	TYP	MAX	UNITS
AMP 2 Gain Variation Over Temperature				1		dB
AMP 2 Noise Figure	NF ₂			1.8		dB
AMP 2 Output Third-Order Intercept Point	OIP3	Two tones at 1574.5MHz and 1575.5MHz, -30dBm per tone		20		dBm
AMP 2 Output 1dB Compression Point				6		dBm
AMP 2 Input Return Loss	S ₁₁ ₂			-18		dB
AMP 2 Output Return Loss	S ₂₂ ₂			-11		dB
AMP 2 Reverse Isolation	S ₁₂ ₂			-27		dB

Note 2: T_A = +25°C and T_A = +105°C are guaranteed by production test. At T_A = -40°C, the minimum and maximum values are guaranteed by design and characterization, unless otherwise noted.

Typical Operating Characteristics

(MAX2678 EV kit, all measurements are calibrated to SMA connectors, $P_{IN} = -40\text{dBm}$, $f_{IN} = 1575\text{MHz}$, inputs and outputs are terminated to 50Ω , $V_{CC} = 5.0\text{V}$, $T_A = +25^\circ\text{C}$, unless otherwise noted.)

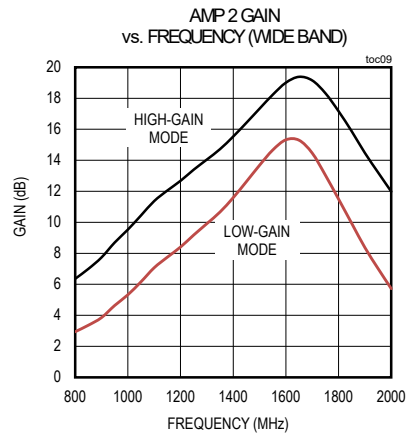
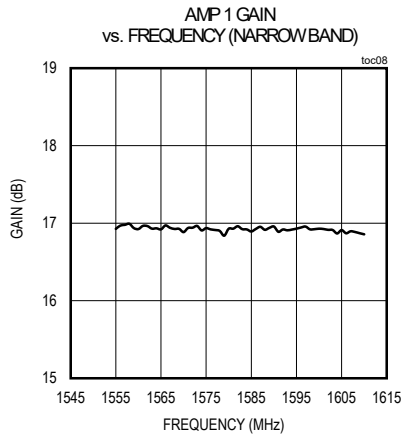
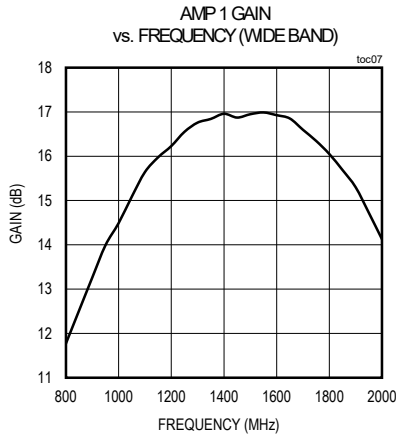
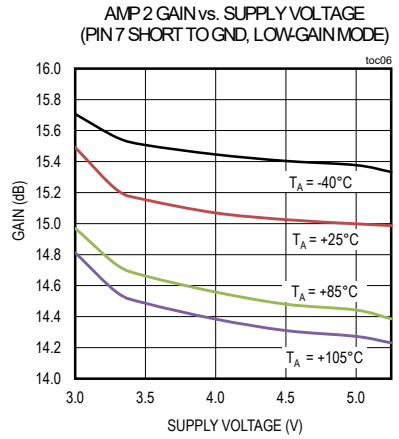
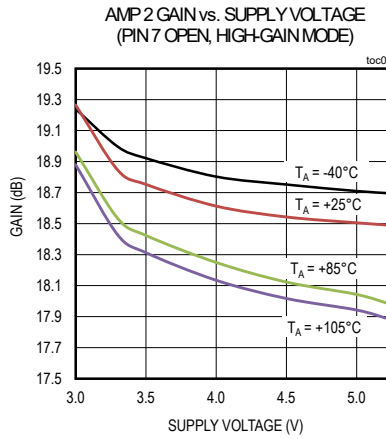
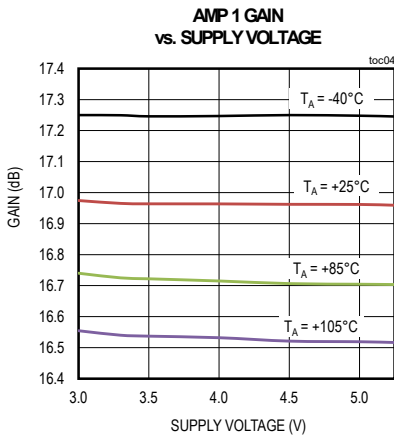
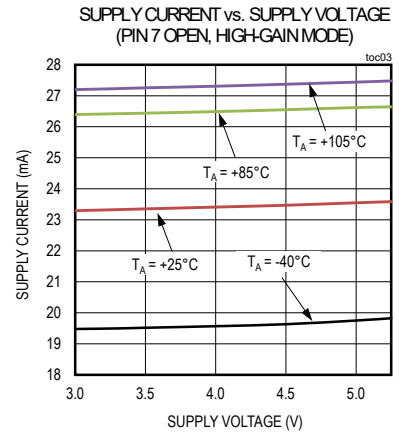
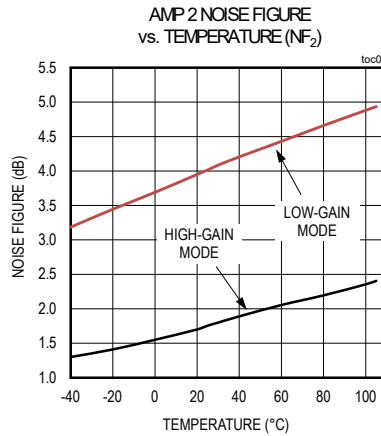
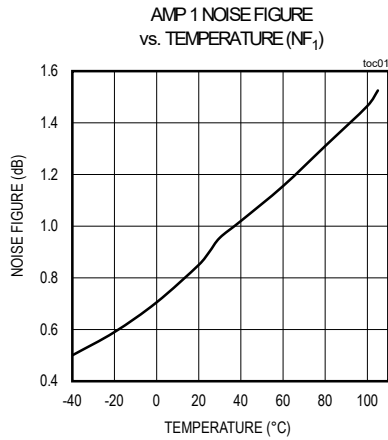

Typical Operating Characteristics (continued)

(MAX2678 EV kit, all measurements are calibrated to SMA connectors, $P_{IN} = -40\text{dBm}$, $f_{IN} = 1575\text{MHz}$, inputs and outputs are terminated to 50Ω , $V_{CC} = 5.0\text{V}$, $T_A = +25^\circ\text{C}$, unless otherwise noted.)

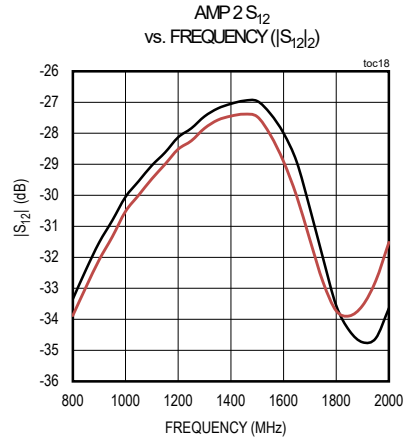
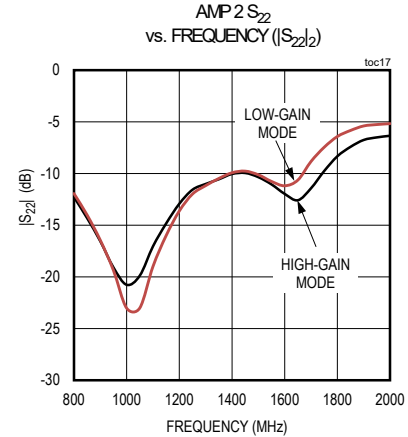
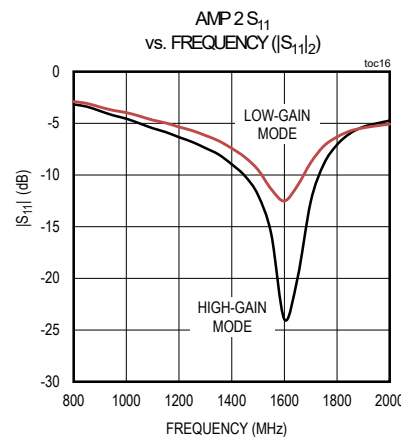
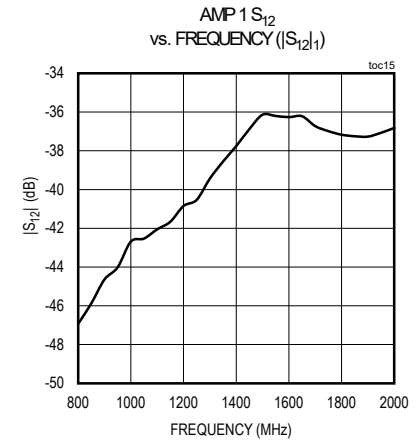
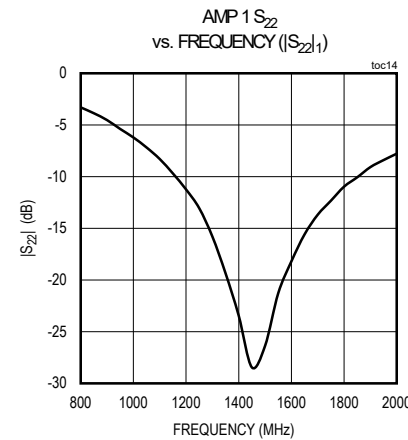
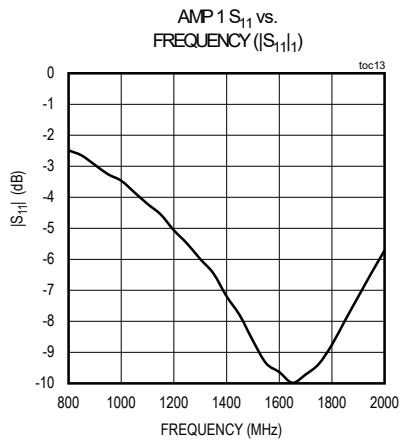
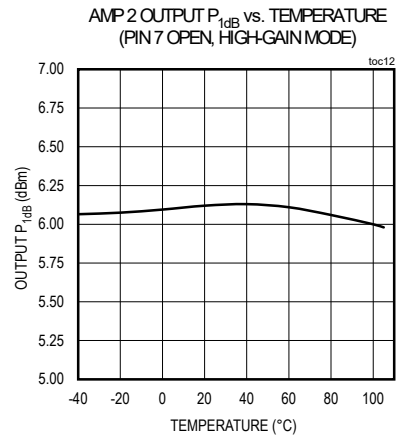
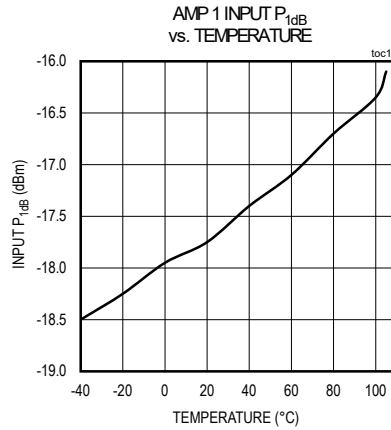
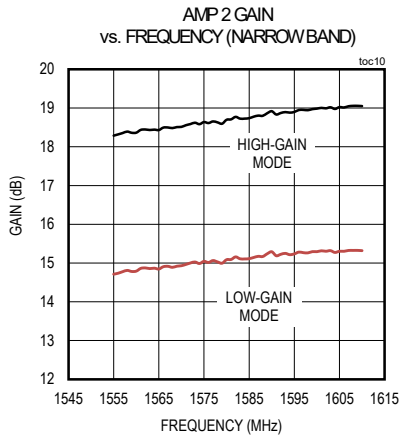

Typical Operating Characteristics (continued)

(MAX2678 EV kit, all measurements are calibrated to SMA connectors, $P_{IN} = -40\text{dBm}$, $f_{IN} = 1575\text{MHz}$, inputs and outputs are terminated to 50Ω , $V_{CC} = 5.0\text{V}$, $T_A = +25^\circ\text{C}$, unless otherwise noted.)

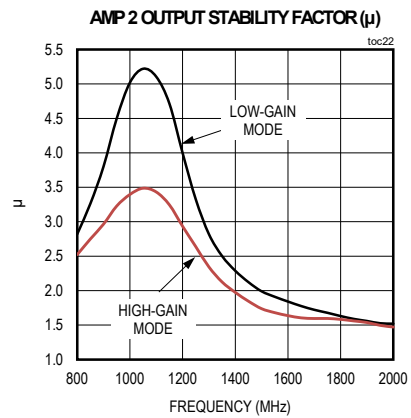
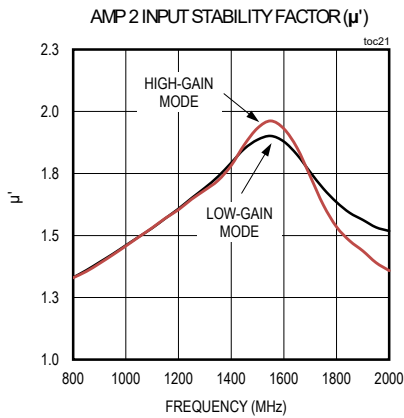
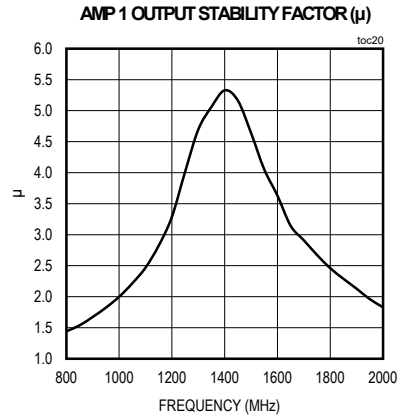
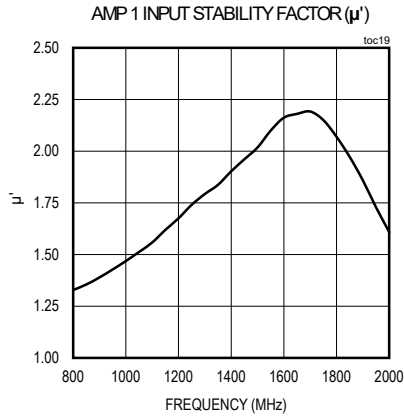

Pin Configuration

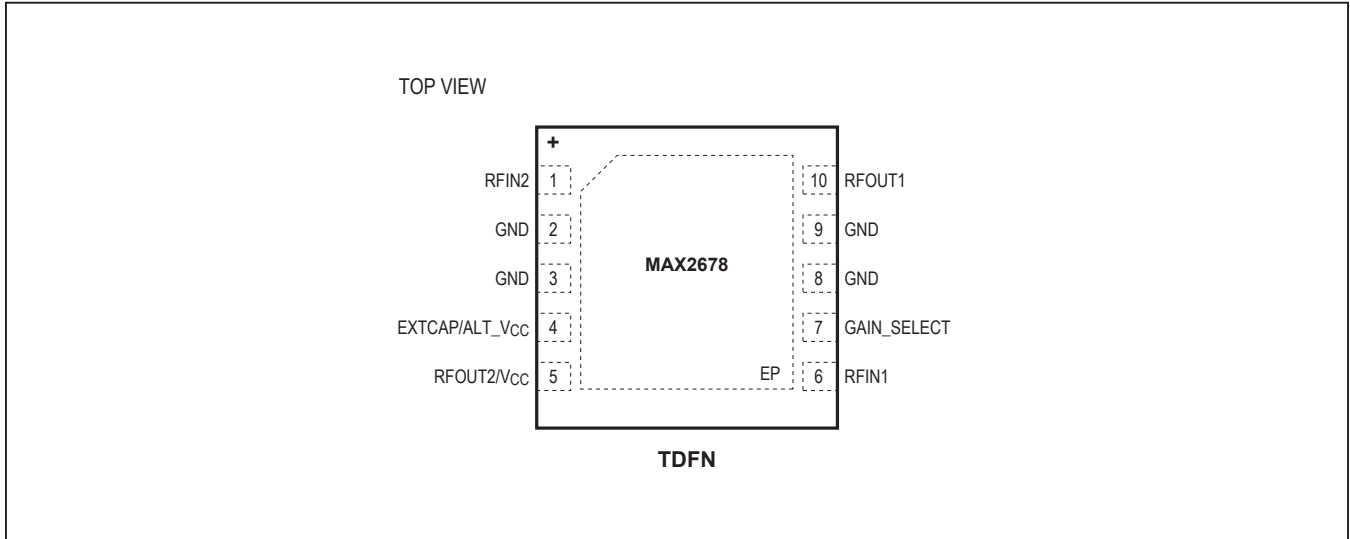

Pin Description

PIN	NAME	FUNCTION
1	RFIN2	Amplifier 2 Input. Incorporates an internal DC-blocking capacitor and is internally matched to 50Ω. This input is designed to be connected to a bandpass filter.
2, 3, 8, 9	GND	Electrical Ground
4	EXTCAP/ ALT_VCC	External Smoothing Capacitor for Internal Supply Voltage. Can be used as the external DC supply pin to eliminate the need for a Bias-T on RFOUT2/VCC.
5	RFOUT2/VCC	Amplifier 2 Output. Incorporates an internal DC-blocking capacitor and is internally matched to 50Ω. DC bias on this pin serves as the power supply through a bias-T.
6	RFIN1	Amplifier 1 Input. Requires an external DC-blocking capacitor and matching components.
7	GAIN_SELECT	Amplifier 2 Gain Select. Open is high-gain mode. Short to ground is low-gain mode.
10	RFOUT1	Amplifier 1 Output. Incorporates an internal DC-blocking capacitor and is internally matched to 50Ω. This output is designed to drive a bandpass filter.
EP	—	Exposed Pad Ground. The exposed pad must be soldered to the circuit board for proper thermal and electrical performance.

Detailed Description

The MAX2678 IC contains two LNA stages tuned for use at 1575MHz.

Amplifier 1

Amplifier 1 (AMP 1) has an internal load that limits the bandwidth and provides a 50Ω output impedance through a DC-blocking capacitor. The internal biasing for AMP 1 suppresses gain variation with changes in temperature and supply voltage. At the input, an integrated DC-blocking capacitor and matching network are intentionally omitted to allow selection of external components to optimize for noise or gain.

Amplifier 2 with Gain Step

The output of Amplifier 2 (AMP 2) has the dual role of providing both the RF output drive and receiving the DC power supply through a single cable. Both the input and output ports of AMP 2 are internally matched to 50Ω impedance at 1575MHz. A 3.4dB gain switch can be used to adjust the gain for different applications. For maximum gain, the GAIN_SELECT pin should be left open. Shorting the GAIN_SELECT pin to ground sets the gain stage to a 3.4dB lower gain. As with AMP 1, AMP 2 has an internal load that limits the bandwidth, and the amplifier's internal biasing suppresses gain variation with changes in temperature and supply voltage.

Alternate Supply (ALT_VCC)

The IC power can be supplied from the navigation system through RFOUT2/V_{CC} (pin 5). An integrated filter is connected to the output of AMP 2 to separate the supply voltage from the GPS signal. Alternatively, the supply voltage can be applied to the EXTCAP/ALT_V_{CC} pin (external capacitor pin 4).

Layout Considerations

For best performance, carefully lay out the PCB using high-frequency techniques. Use controlled-impedance transmission lines to interface with the MAX2678 high-speed inputs and outputs and isolate the input signals from the output signals as much as possible. For improved noise figure, keep the connection to the input of LNA 1 as short as possible. A power-supply decoupling capacitor should be placed very close to pin 4 and connected directly to a ground plane. If low-gain selection for LNA 2 is required, connect pin 7 directly to the ground plane with a very short PCB trace. Good grounding is critical for this device. The backside ground plane should be as close as possible.

Visit www.maximintegrated.com/evkitsoftware to download the latest MAX2678 EV kit BOM, schematic and PCB layout diagrams, including Gerber data.

Typical Operating Circuit

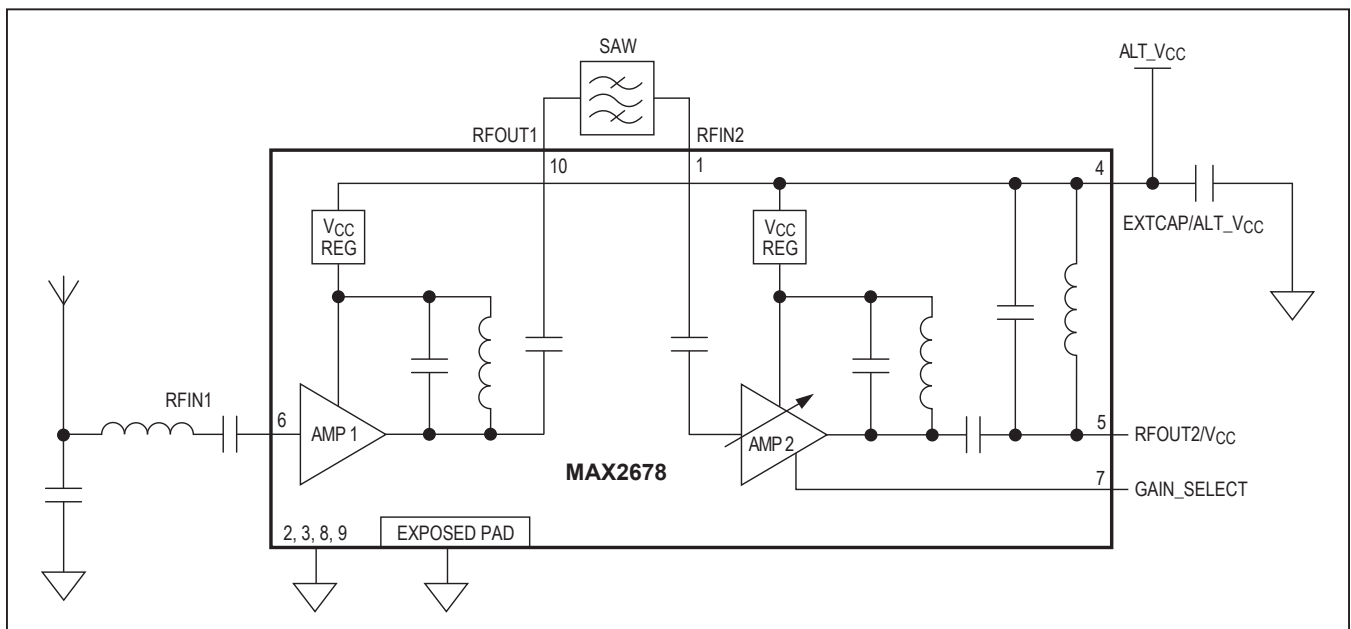

Ordering Information

PART	TEMP RANGE	PIN-PACKAGE
MAX2678GTB/V+	-40°C to +105°C	10 TDFN-EP*
MAX2678GTB/V+T	-40°C to +105°C	10 TDFN-EP*

V denotes an automotive qualified part.
+Denotes a lead(Pb)-free/RoHS-compliant package.
T = Tape and reel.
**EP = Exposed pad.*

Package Information

For the latest package outline information and land patterns (footprints), go to www.maximintegrated.com/packages. Note that a "+", "#", or "-" in the package code indicates RoHS status only. Package drawings may show a different suffix character, but the drawing pertains to the package regardless of RoHS status.

PACKAGE TYPE	PACKAGE CODE	OUTLINE NO.	LAND PATTERN NO.
10 TDFN-EP	T1033+4	21-0137	90-0061

Revision History

REVISION NUMBER	REVISION DATE	DESCRIPTION	PAGES CHANGED
0	10/16	Initial release	—
1	11/18	Added Package Thermal Characteristics (Note 1) and updated Absolute Maximum Ratings	2

For pricing, delivery, and ordering information, please contact Maxim Direct at 1-888-629-4642, or visit Maxim Integrated's website at www.maximintegrated.com.

Maxim Integrated cannot assume responsibility for use of any circuitry other than circuitry entirely embodied in a Maxim Integrated product. No circuit patent licenses are implied. Maxim Integrated reserves the right to change the circuitry and specifications without notice at any time. The parametric values (min and max limits) shown in the Electrical Characteristics table are guaranteed. Other parametric values quoted in this data sheet are provided for guidance.