

APPROVED: _____

DATE: _____ TITLE: _____



Rev	AWO #	Description	Date	Appr
-		RELEASED	8/16/21	
A		UPDATE DRAWING	3/2/23	LH/AC1
B		UPDATED SPEC.	3/16/23	JJ/KC

MMI-M1PXXXSXX

ALIGNMENT KEY	
G	= 0°
A	= 30°
B	= 60°
C	= 90°

CABLE COLLET SIZE	
42	= 3.2mm ~ 4.2mm ID
52	= 4.2mm ~ 5.2mm ID
62	= 5.2mm ~ 6.2mm ID
72	= 6.2mm ~ 7.2mm ID

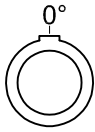
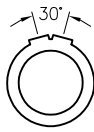
OF POSITIONS
02, 03, 04, 05, 06, 07, 08, 10, 14 & 16



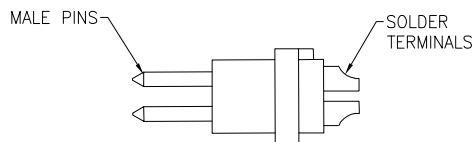
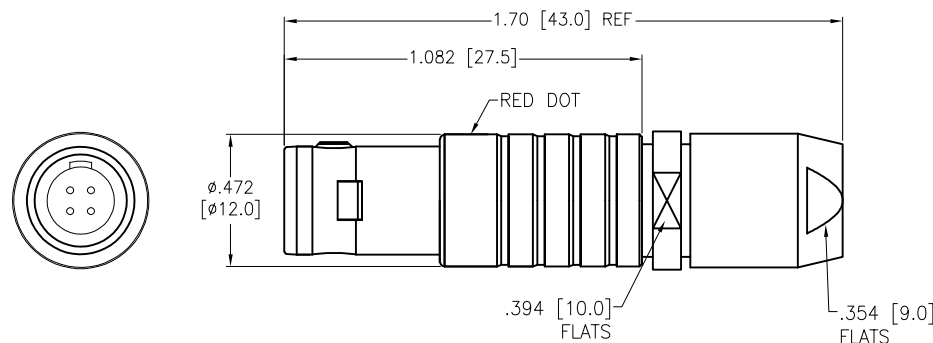



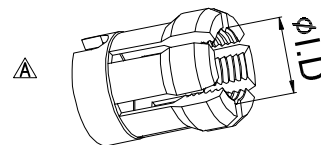



ALIGNMENT KEY OPTION			
			
KEY G	KEY A	KEY B	KEY C



DETAIL



CABLE COLLET

	2 Pin	3 Pin	4 Pin	5 Pin	6 Pin	7 Pin	8 Pin	10 Pin	14 Pin	16 Pin
Configuration										
Diameter of Pin	phi 1.3	phi 1.3	phi 0.9	phi 0.9	phi 0.7	phi 0.7	phi 0.7	phi 0.5	phi 0.5	phi 0.5
Testing Voltage	1350V	1300V	1350V	1150V	1050V	950V	950V	900V	800V	800V
Rated Current / Pin	9A	9A	8A	7A	5A	5A	5A	2A	2A	2A
Max. Wire Awg	20	20	22	22	22	22	22	28	28	28

SPECIFICATIONS:

Material:
 Housing (Body): Brass, Natural Chrome plated
 Insulator: PPS
 Terminal: Brass, Gold Plated
 Electrical:
 Voltage Rating: Refer to chart
 Current Rating: See chart
 Dielectric withstanding voltage: See chart
 Electrical Life: 5,000 Cycles min.
 Temperature Rating:
 Operating temperature: -55°C to +150°C
 Environmental:
 IP50 Protection (Mated Condition)
 Lead free, RoHS compliant



UNLESS OTHERWISE SPECIFIED ALL DIMENSIONS ARE INCHES [MM]. TOLERANCES: EXCEPT AS NOTED			
INCHES		HOLES	
.X	± .10	Ø.X	± .10
.XX	± .020	Ø.XX	± .015
.XXX	± .015	Ø.XXX	± .010

DRAWN	SS	8/16/21
CHECKED	SS	8/16/21
APPROVED		

THIS DRAWING CONTAINS INFORMATION THAT IS PROPRIETARY AND SHOULD NOT BE USED WITHOUT PRIOR WRITTEN PERMISSION FROM ADAM TECH



909 Rahway Avenue,
 Union, NJ 07083
 Phone: 908-687-5000
 Fax: 908-687-5710

TITLE
**PUSH-PULL CONNECTOR MALE PLUG, METAL,
 SIZE 1, SOLDER TERMINAL, IP50**

SIZE X	PART NO. MMI-M1PXXXSXX	REV. B
REF: S00210C	SCALE: NTS	SHEET 1 OF 1