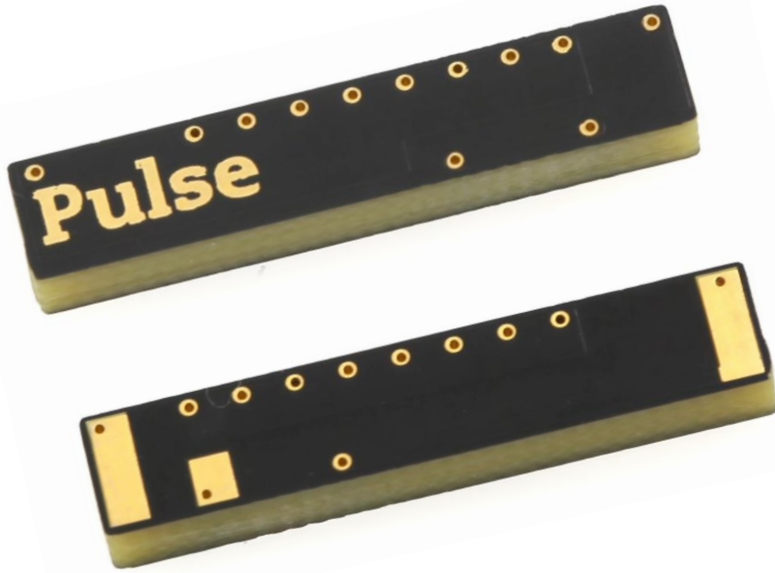

Description: ISM 868/915MHz,2400-2483.5MHz SMD ANTENNA**Series: Domino****PART NUMBER: W3330****Features:**

- Tri-Band ISM antenna
 - Port 1 LB 844-928MHz
 - Port 2 HB 2400-2483,5MHz
- Size 25.1x5x3mm
- Efficiency 60%
- Nominal impedance 50 Ω
- Fully SMD and Reflow/IR/Wave-soldering compatible
- Moisture Sensitivity Level MSL3

Applications:

- ISM Band radios
- Bluetooth, BLE, Zigbee, WiFi
- M2M, IoT

All dimensions are in mm / inches

Issue: 2045

In the effort to improve our products, we reserve the right to make changes judged to be necessary.

CONFIDENTIAL AND PROPRIETARY INFORMATION

This document contains confidential and proprietary information of Pulse Electronics, Inc. (Pulse) and is protected by copyright, trade secret and other state and federal laws. Its receipt or possession does not convey any rights to reproduce, disclose its contents, or to manufacture, use or sell anything it may describe. Reproduction, disclosure or use without specific written authorization of Pulse is strictly forbidden.

For more information:

Pulse Worldwide Headquarters
12220 World Trade Drive
San Diego, CA 92128
USA
Tel:1-858-674-8100

Pulse/Larsen Antennas
18110 SE 34th St Bldg 2 Suite 250
Vancouver, WA 98683
USA
Tel: 1-360-944-7551

Europe Headquarters
Pulse GmbH & Do, KG
Zeppelinstrasse 15
Herrenberg, Germany
Tel: 49 7032 7806 0

Pulse (Suzhou) Wireless Products Co, Inc.
99 Huo Ju Road(#29 Bldg,4th Phase
Suzhou New District
Jiangsu Province, Suzhou 215009 PR China
Tel: 86 512 6807 9998



Description: ISM 868/915MHz,2400-2483.5MHz SMD ANTENNA**Series: Domino****PART NUMBER: W3330****ELECTRICAL SPECIFICATIONS**

Frequency	844-928/2400-2483.5 MHz
Nominal Impedance	50 Ω
VSWR	3:1
Return loss	-6 dB
Isolation P1-P2	>15 dB
Total Efficiency (844-928MHz)	60 %
Total Efficiency (2400-2483.5MHz)	60 %
Peak Gain (844-928MHz)	0.4 dBi
Peak Gain (2400-2483.5MHz)	2 dBi
Average Gain (844-928MHz)	-2.2 dBi
Average Gain (2400-2483.5MHz)	-2.2 dBi
Maximum power input	5 W

(*) All RF parameters measured on Pulse reference test PCB

Description: ISM 868/915MHz,2400-2483.5MHz SMD ANTENNA**Series: Domino****PART NUMBER: W3330****MECHANICAL SPECIFICATIONS**

Color	Black
Size(L X W X T)	25.1 X 5 X 3 mm
Weight	1.5 g
Fixing system	SMD
MSL (Moisture Sensitivity Level)	3

ENVIRONMENTAL SPECIFICATIONS

Operating temperature	-40/+85 °C
Temperature	-40/+85 °C
Humidity	93% RH @ 30° C 24 hours
Drop test	1 m

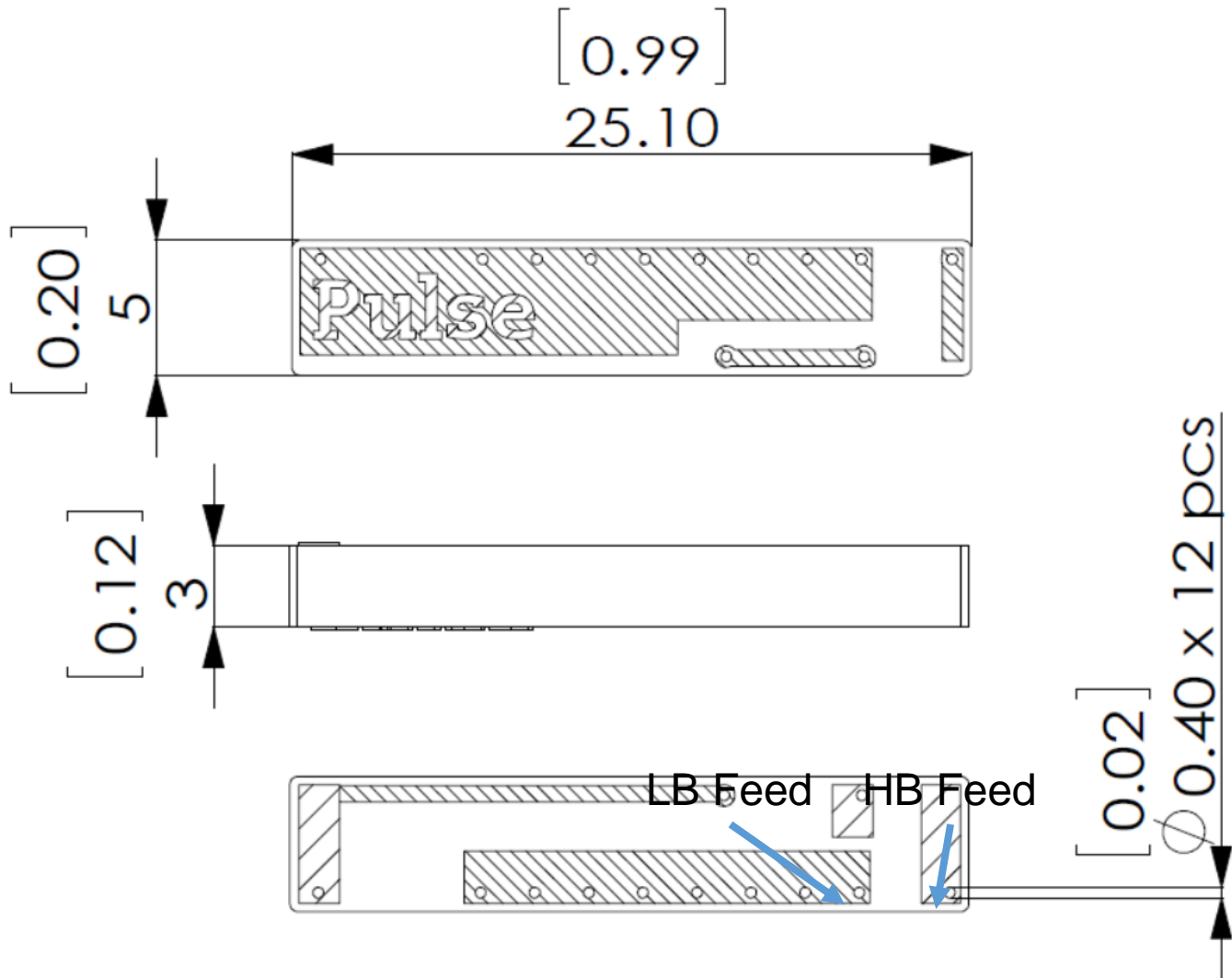
Description: ISM 868/915MHz,2400-2483.5MHz SMD ANTENNA**Series: Domino****PART NUMBER: W3330****MECHANICAL DRAWING**

Issue: 2045

In the effort to improve our products, we reserve the right to make changes judged to be necessary.

CONFIDENTIAL AND PROPRIETARY INFORMATION

This document contains confidential and proprietary information of Pulse Electronics, Inc. (Pulse) and is protected by copyright, trade secret and other state and federal laws. Its receipt or possession does not convey any rights to reproduce, disclose its contents, or to manufacture, use or sell anything it may describe. Reproduction, disclosure or use without specific written authorization of Pulse is strictly forbidden.

Description: ISM 868/915MHz,2400-2483.5MHz SMD ANTENNA

Series: Domino

PART NUMBER: W3330

OTHER SPECIFICATIONS

Pulse reference test PCB for W3330 antenna

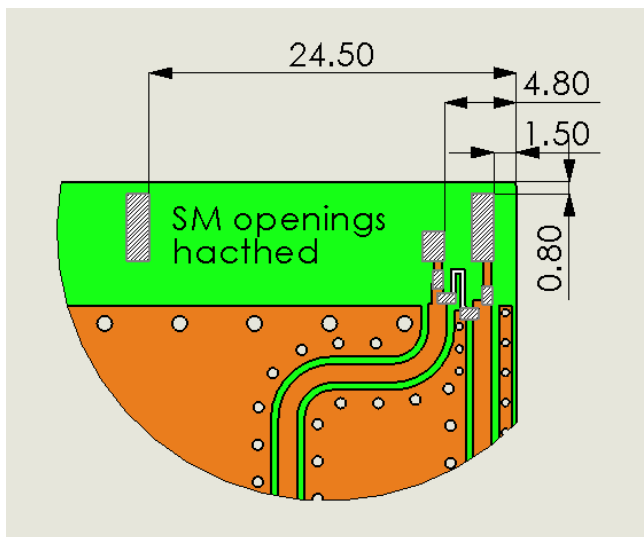
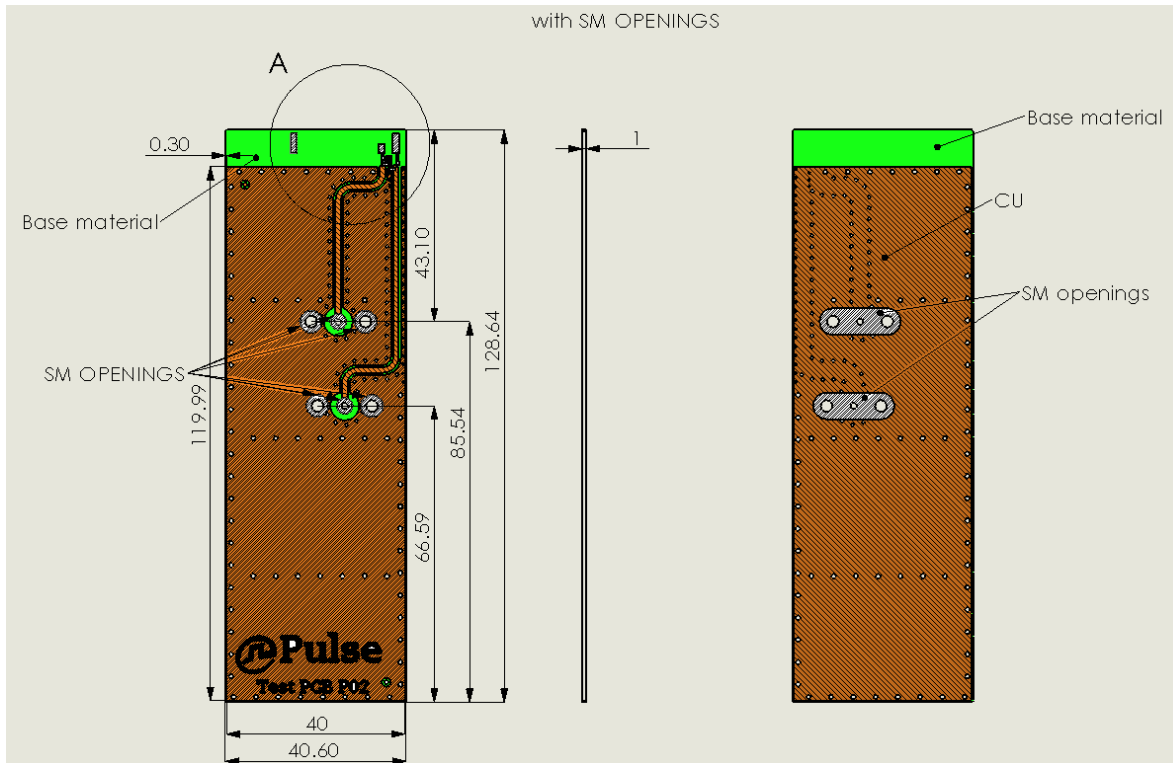

All dimensions are in mm

Issue: 2045

In the effort to improve our products, we reserve the right to make changes judged to be necessary.

CONFIDENTIAL AND PROPRIETARY INFORMATION

This document contains confidential and proprietary information of Pulse Electronics, Inc. (Pulse) and is protected by copyright, trade secret and other state and federal laws. Its receipt or possession does not convey any rights to reproduce, disclose its contents, or to manufacture, use or sell anything it may describe. Reproduction, disclosure or use without specific written authorization of Pulse is strictly forbidden.

Description: ISM 868/915MHz,2400-2483.5MHz SMD ANTENNA

Series: Domino

PART NUMBER: W3330

OTHER SPECIFICATIONS

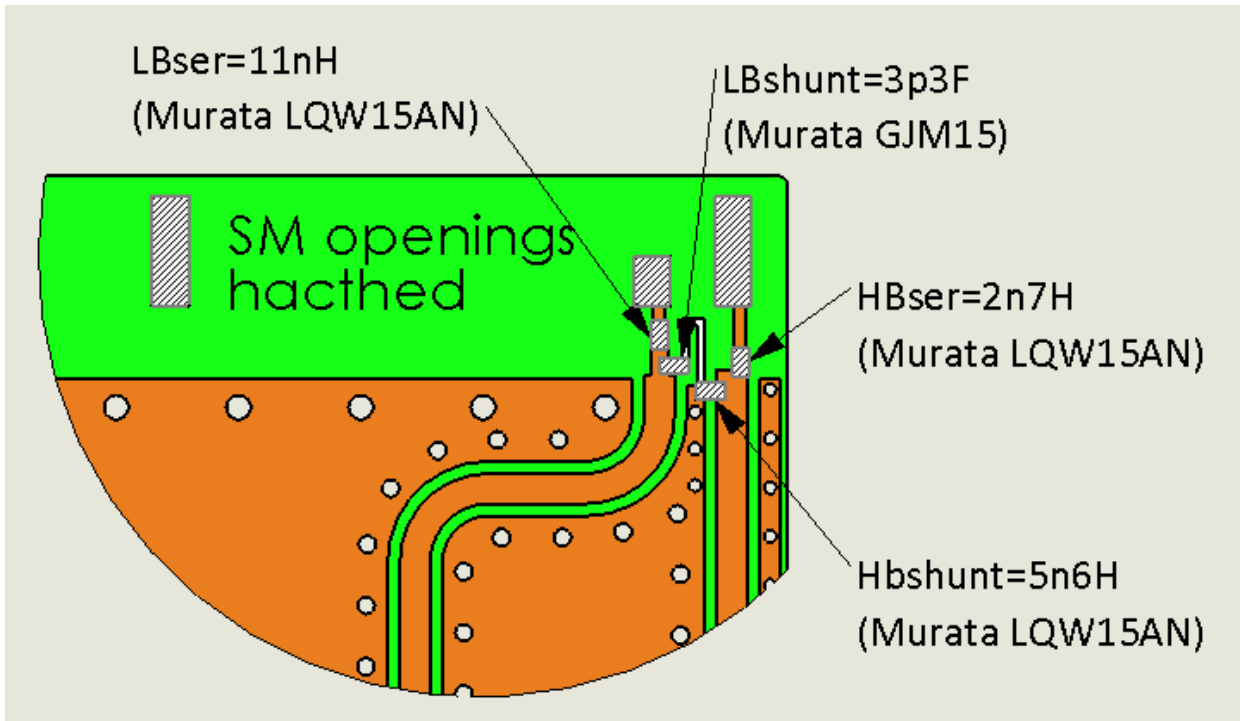

Recommended test board PCB layout for electrical characteristic measurement. Substrate material FR4, thickness 1mm

All dimensions are in mm

OTHER SPECIFICATIONS

Recommendation for reflow soldering process

Printing stencil thickness 0,15 - 0,25 mm is recommended for the solder paste. The maximum soldering temperature should not exceed 260°C. The temperature profile recommendations for reflow soldering process is presented in the Figures 1 and 2. The reflow profile

presented in figure 1 describes minimum reflow temperatures. The reflow profile presented in figure 2 describes maximum reflow temperatures. located at the center of the coverage area.

	Method of heat transfer	Controlled hot air convection
1	Average temperature gradient in preheating	2.5 °C/s
2	Soak time	2-3 minutes
3	Max temperature gradient in reflow	3 °C/s
4	Time above 217 °C	Max 30 sec
5	Peak temperature in reflow	230 °C for 10 seconds
6	Temperature gradient in cooling	Max -5 °C/s

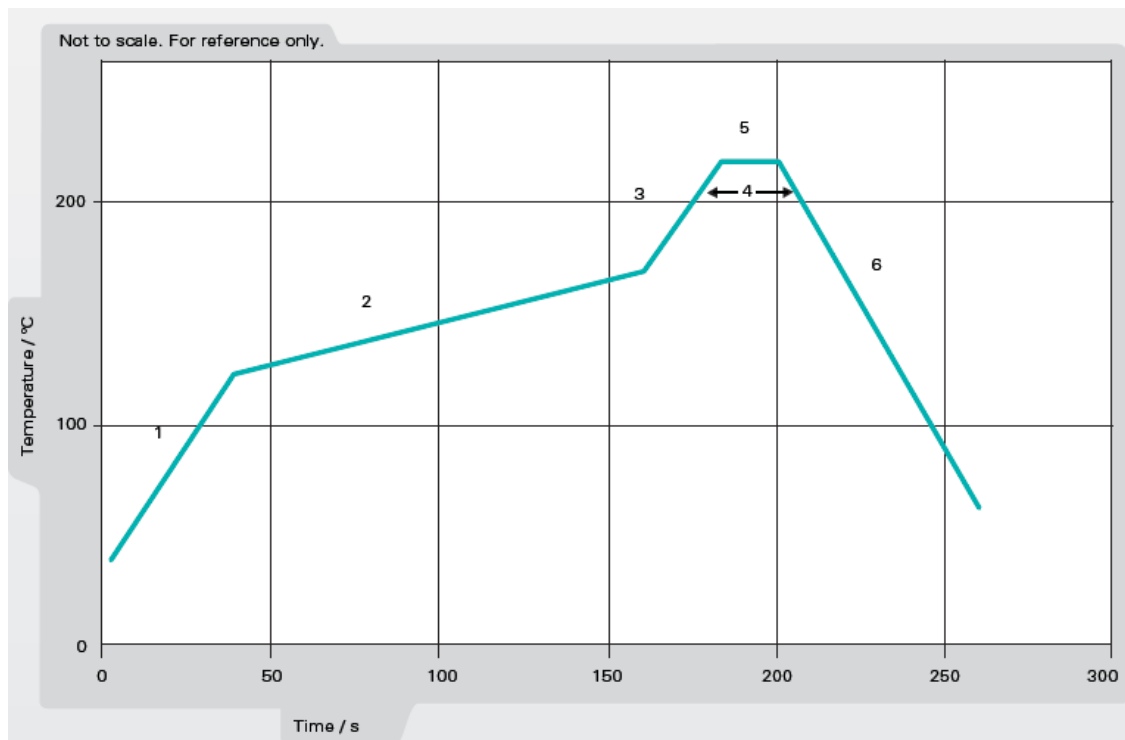

Figure 1. Minimum temperature profile recommendation for reflow soldering process

Issue: 2045

In the effort to improve our products, we reserve the right to make changes judged to be necessary.

CONFIDENTIAL AND PROPRIETARY INFORMATION

This document contains confidential and proprietary information of Pulse Electronics, Inc. (Pulse) and is protected by copyright, trade secret and other state and federal laws. Its receipt or possession does not convey any rights to reproduce, disclose its contents, or to manufacture, use or sell anything it may describe. Reproduction, disclosure or use without specific written authorization of Pulse is strictly forbidden.

Description: ISM 868/915MHz,2400-2483.5MHz SMD ANTENNA

Series: Domino

PART NUMBER: W3330

OTHER SPECIFICATIONS

	Method of heat transfer	Controlled hot air convection
1	Average temperature gradient in preheating	2.5 °C/s
2	Soak time	2-3 minutes
3	Max temperature gradient in reflow	3 °C/s
4	Time above 217 °C	Max 60 sec
5	Time above 230 °C	Max 50 sec
6	Time above 250 °C	Max 10 sec
7	Peak temperature in reflow	260 °C for 5 seconds
8	Temperature gradient in cooling	Max -5 °C/s

Not to scale. For reference only.

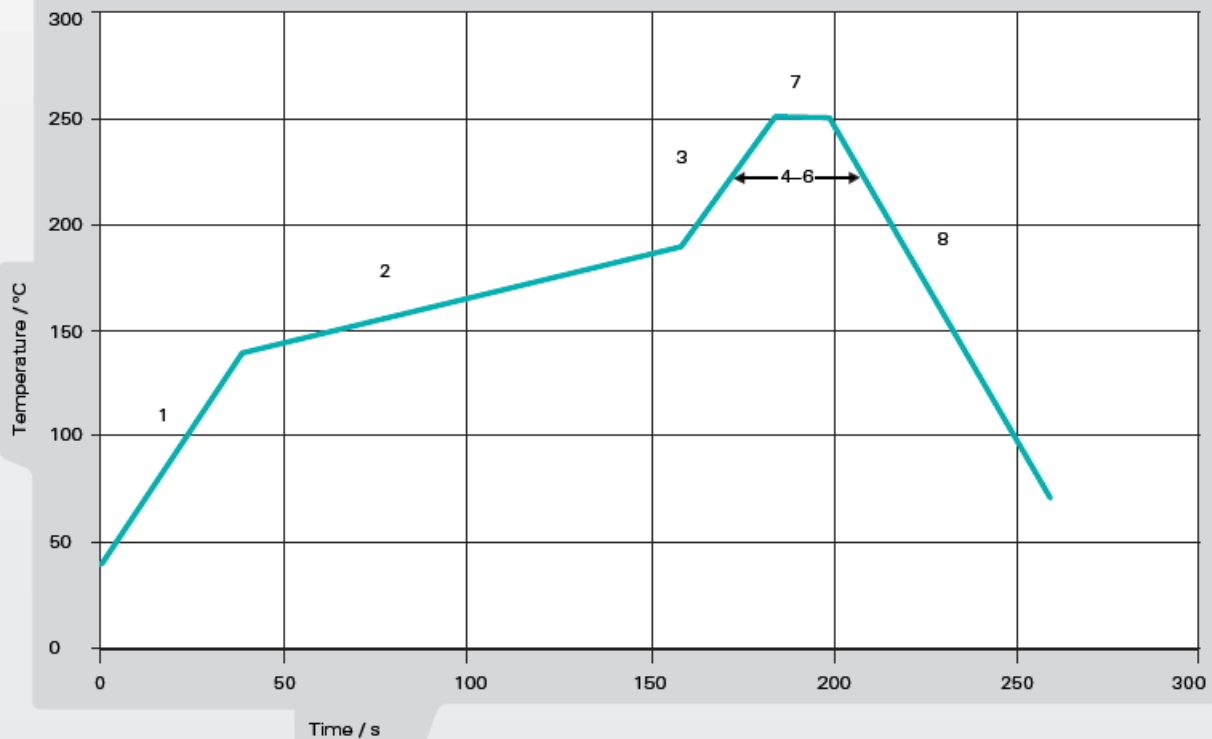

Figure 2. Maximum temperature profile recommendation for reflow soldering process

Issue: 2045

In the effort to improve our products, we reserve the right to make changes judged to be necessary.

CONFIDENTIAL AND PROPRIETARY INFORMATION

This document contains confidential and proprietary information of Pulse Electronics, Inc. (Pulse) and is protected by copyright, trade secret and other state and federal laws. Its receipt or possession does not convey any rights to reproduce, disclose its contents, or to manufacture, use or sell anything it may describe. Reproduction, disclosure or use without specific written authorization of Pulse is strictly forbidden.

Description: ISM 868/915MHz,2400-2483.5MHz SMD ANTENNA

Series: Domino

PART NUMBER: W3330

CHARTS

Free space measurements on Pulse reference test PCB

Low Band Return Loss in free space, dB

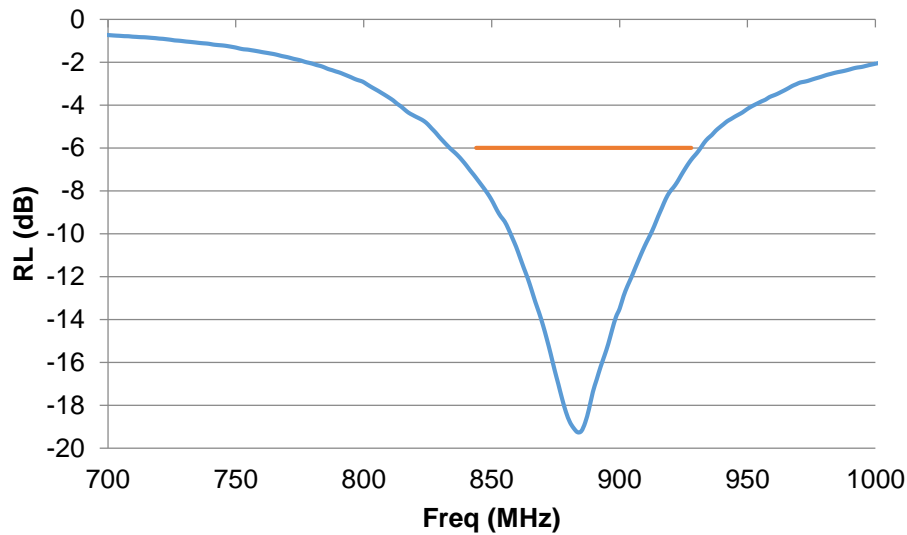

High Band Return Loss in free space, dB

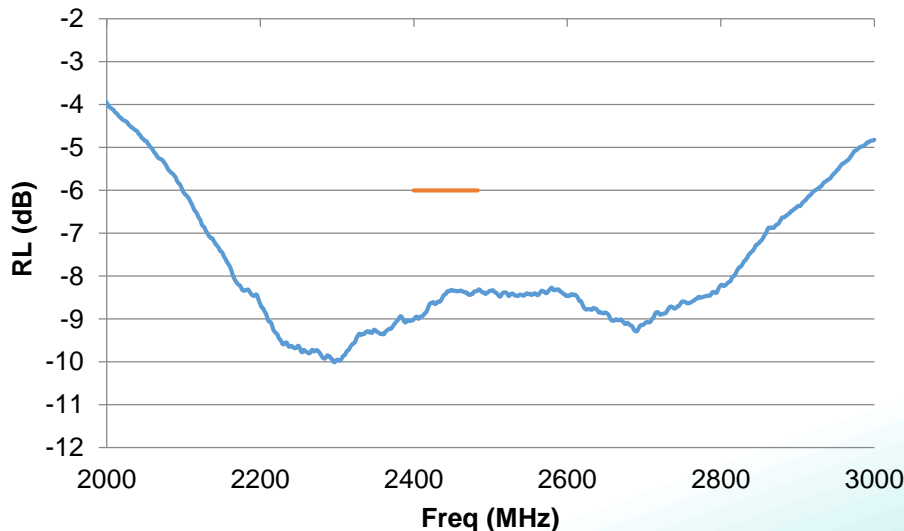

Issue: 2045

In the effort to improve our products, we reserve the right to make changes judged to be necessary.

CONFIDENTIAL AND PROPRIETARY INFORMATION

This document contains confidential and proprietary information of Pulse Electronics, Inc. (Pulse) and is protected by copyright, trade secret and other state and federal laws. Its receipt or possession does not convey any rights to reproduce, disclose its contents, or to manufacture, use or sell anything it may describe. Reproduction, disclosure or use without specific written authorization of Pulse is strictly forbidden.

Description: ISM 868/915MHz,2400-2483.5MHz SMD ANTENNA**Series: Domino****PART NUMBER: W3330****CHARTS**

Isolation between low band port and high band port

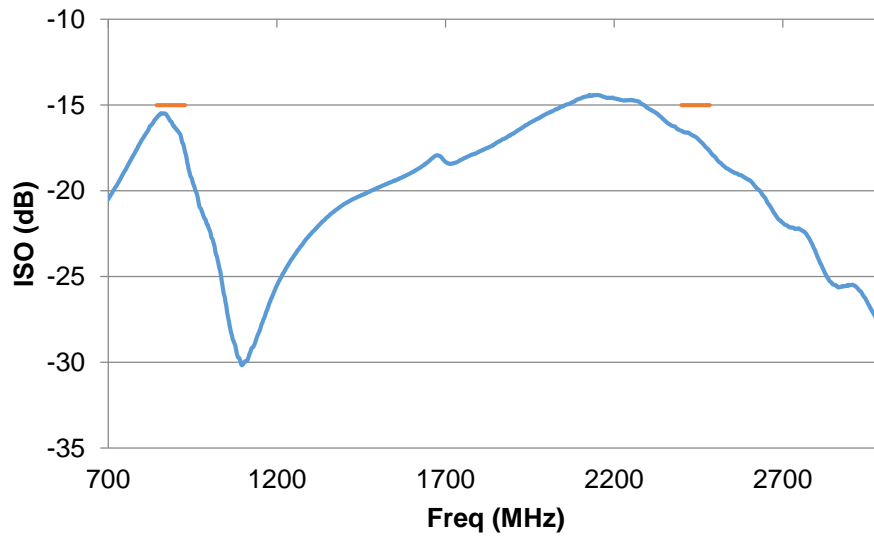

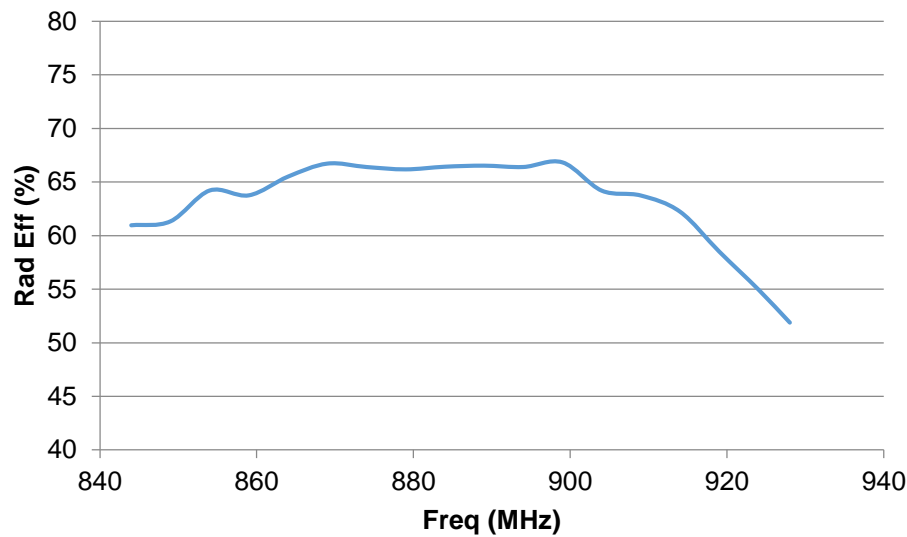
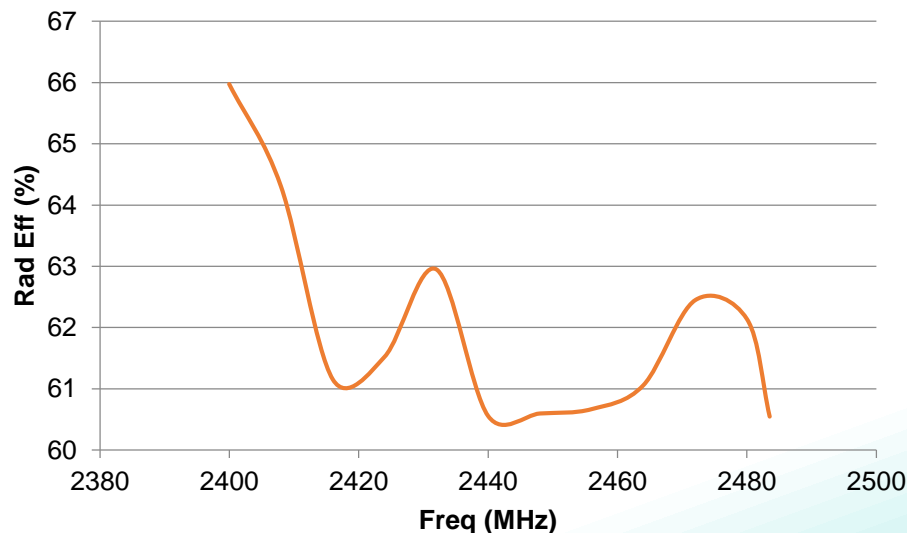
Description: ISM 868/915MHz,2400-2483.5MHz SMD ANTENNA**Series: Domino****PART NUMBER: W3330****CHARTS****Radiation Efficiency in free space - Low band (%)****Radiation Efficiency in free space - High band (%)**

Issue: 2045

In the effort to improve our products, we reserve the right to make changes judged to be necessary.

CONFIDENTIAL AND PROPRIETARY INFORMATION

This document contains confidential and proprietary information of Pulse Electronics, Inc. (Pulse) and is protected by copyright, trade secret and other state and federal laws. Its receipt or possession does not convey any rights to reproduce, disclose its contents, or to manufacture, use or sell anything it may describe. Reproduction, disclosure or use without specific written authorization of Pulse is strictly forbidden.

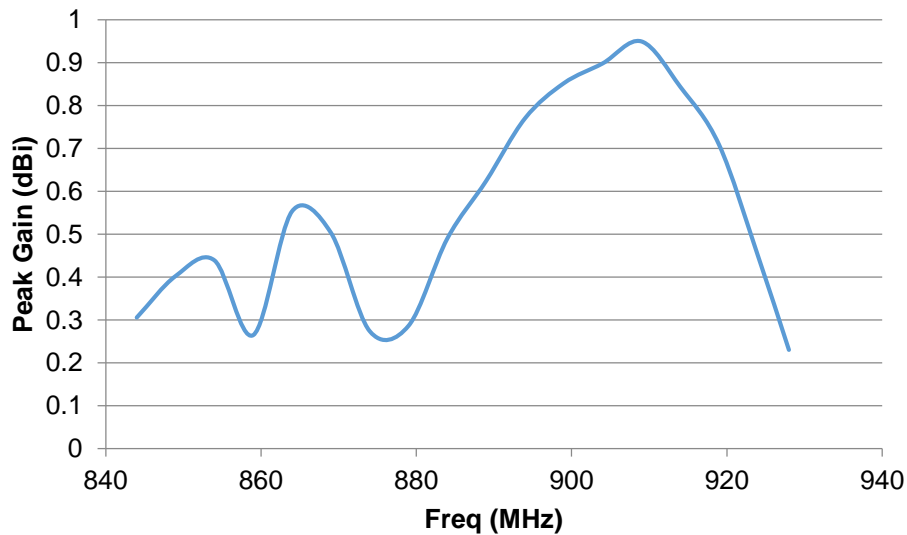
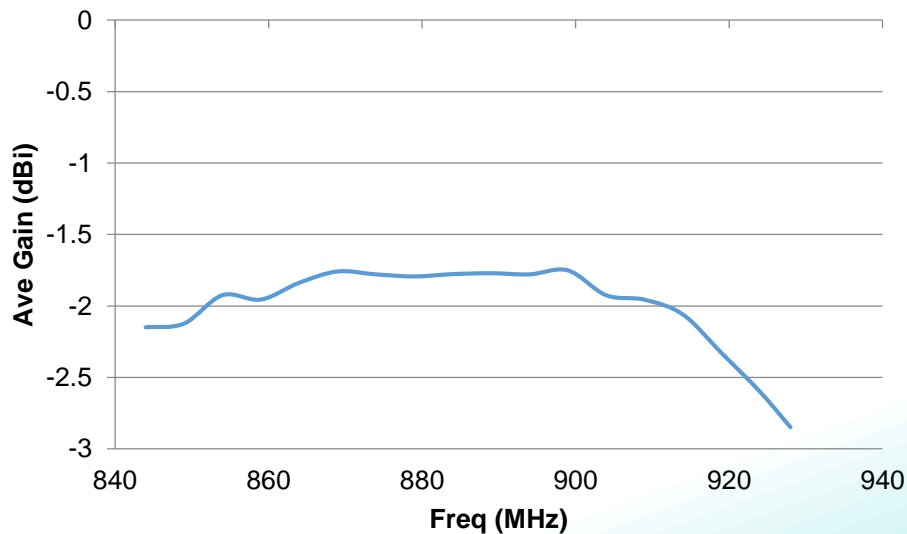
Description: ISM 868/915MHz,2400-2483.5MHz SMD ANTENNA**Series: Domino****PART NUMBER: W3330****CHARTS****Peak gain - Low band (dBi)****Average gain - Low band (dBi)**

Issue: 2045

In the effort to improve our products, we reserve the right to make changes judged to be necessary.

CONFIDENTIAL AND PROPRIETARY INFORMATION

This document contains confidential and proprietary information of Pulse Electronics, Inc. (Pulse) and is protected by copyright, trade secret and other state and federal laws. Its receipt or possession does not convey any rights to reproduce, disclose its contents, or to manufacture, use or sell anything it may describe. Reproduction, disclosure or use without specific written authorization of Pulse is strictly forbidden.

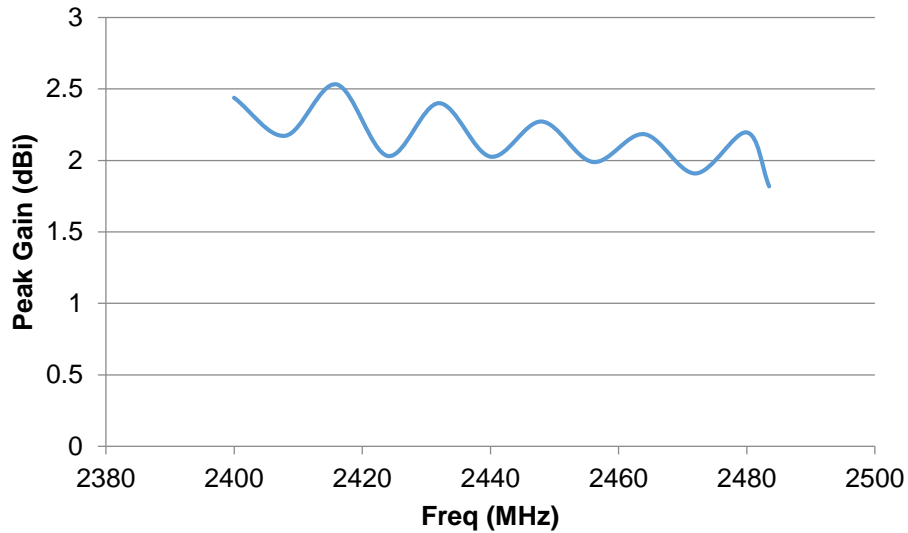
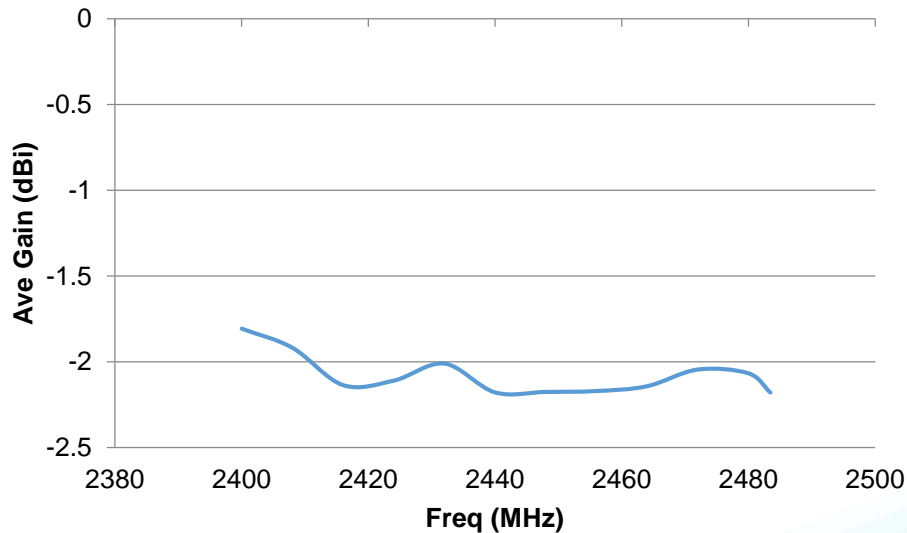
Description: ISM 868/915MHz,2400-2483.5MHz SMD ANTENNA**Series: Domino****PART NUMBER: W3330****CHARTS****Peak gain - High band (dBi)****Average gain - High band (dBi)**

Issue: 2045

In the effort to improve our products, we reserve the right to make changes judged to be necessary.

CONFIDENTIAL AND PROPRIETARY INFORMATION

This document contains confidential and proprietary information of Pulse Electronics, Inc. (Pulse) and is protected by copyright, trade secret and other state and federal laws. Its receipt or possession does not convey any rights to reproduce, disclose its contents, or to manufacture, use or sell anything it may describe. Reproduction, disclosure or use without specific written authorization of Pulse is strictly forbidden.

Description: ISM 868/915MHz,2400-2483.5MHz SMD ANTENNA

Series: Domino

PART NUMBER: W3330

CHARTS 844-928MHz

Vertical plot, side view

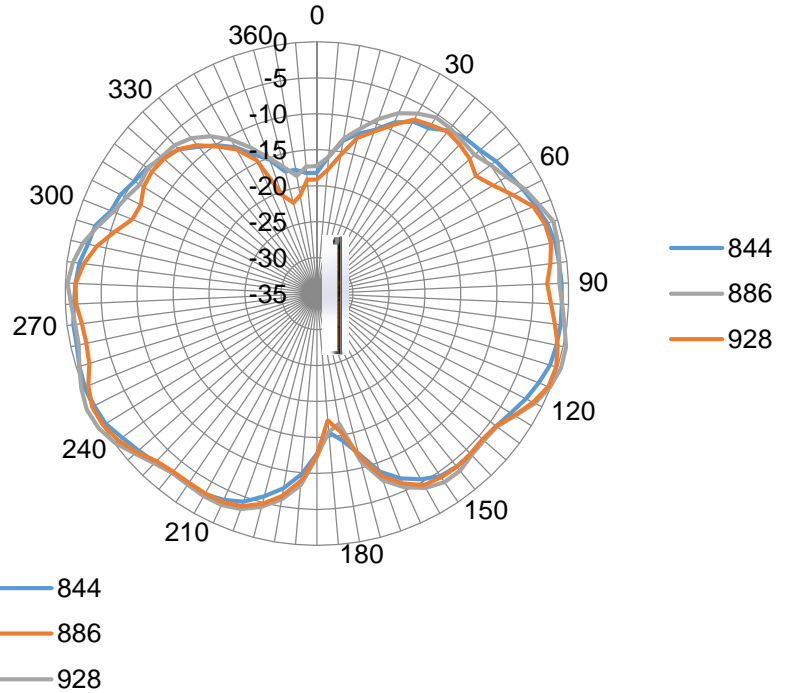

Vertical plot, front view

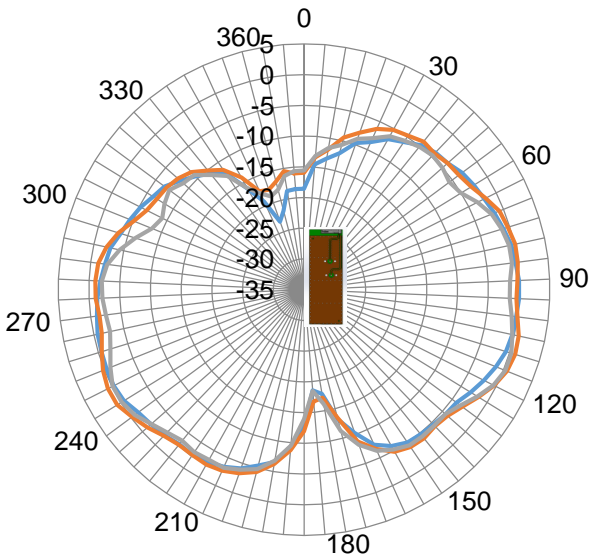

Horizontal plot

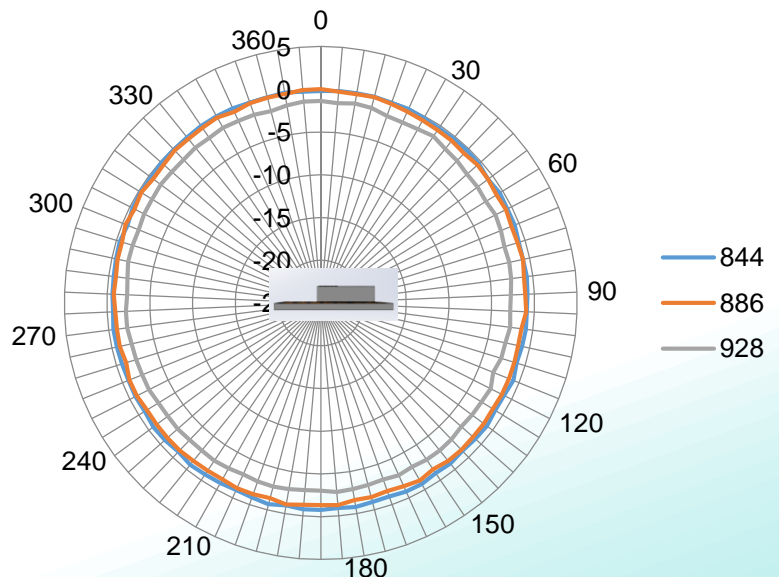

Issue: 2045

In the effort to improve our products, we reserve the right to make changes judged to be necessary.

CONFIDENTIAL AND PROPRIETARY INFORMATION

This document contains confidential and proprietary information of Pulse Electronics, Inc. (Pulse) and is protected by copyright, trade secret and other state and federal laws. Its receipt or possession does not convey any rights to reproduce, disclose its contents, or to manufacture, use or sell anything it may describe. Reproduction, disclosure or use without specific written authorization of Pulse is strictly forbidden.

Description: ISM 868/915MHz,2400-2483.5MHz SMD ANTENNA

Series: Domino

PART NUMBER: W3330

CHARTS 2400-2483.5MHz

Vertical plot, front view

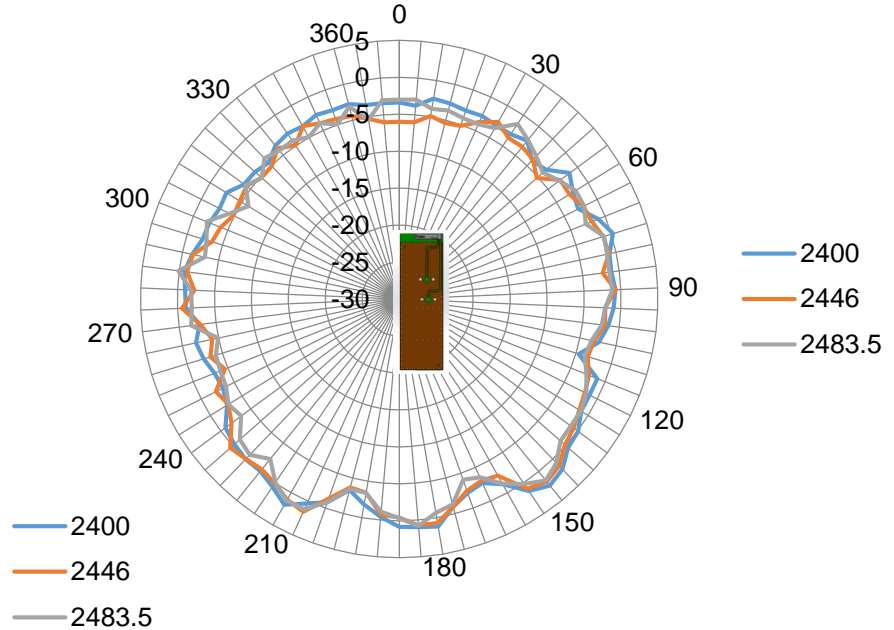

Horizontal plot

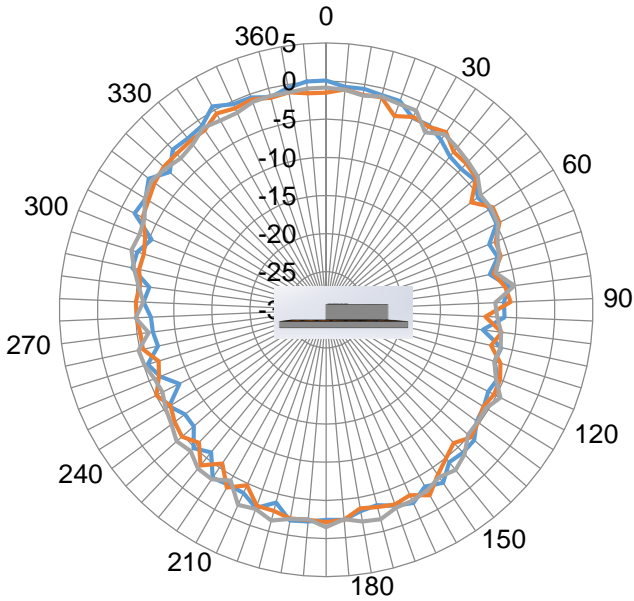

Vertical plot, side view

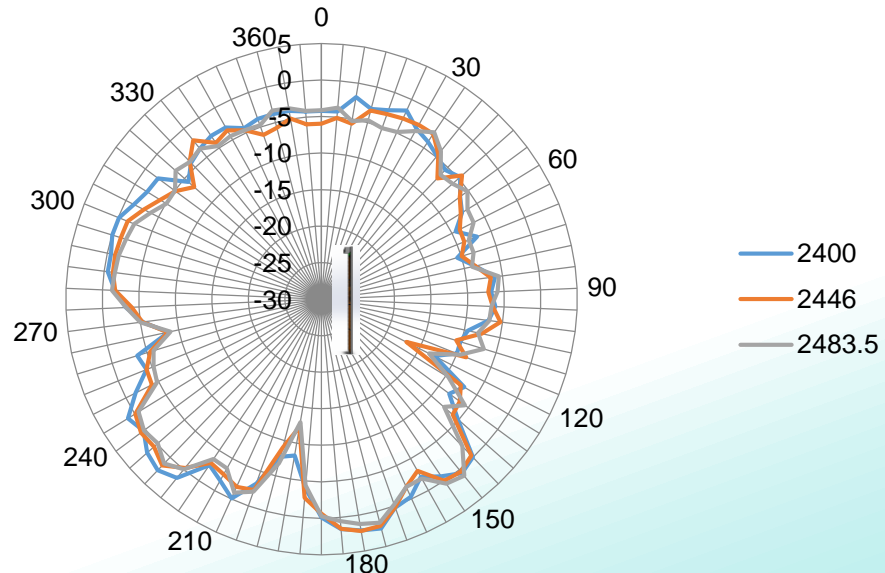

Issue: 2045

In the effort to improve our products, we reserve the right to make changes judged to be necessary.

CONFIDENTIAL AND PROPRIETARY INFORMATION

This document contains confidential and proprietary information of Pulse Electronics, Inc. (Pulse) and is protected by copyright, trade secret and other state and federal laws. Its receipt or possession does not convey any rights to reproduce, disclose its contents, or to manufacture, use or sell anything it may describe. Reproduction, disclosure or use without specific written authorization of Pulse is strictly forbidden.

Description: ISM 868/915MHz,2400-2483.5MHz SMD ANTENNA

Series: Domino

PART NUMBER: W3330

PACKAGING

Reel packing, 1400 PCS/Reel
2 Reels/Carton box, total 2800 PCS/Carton box

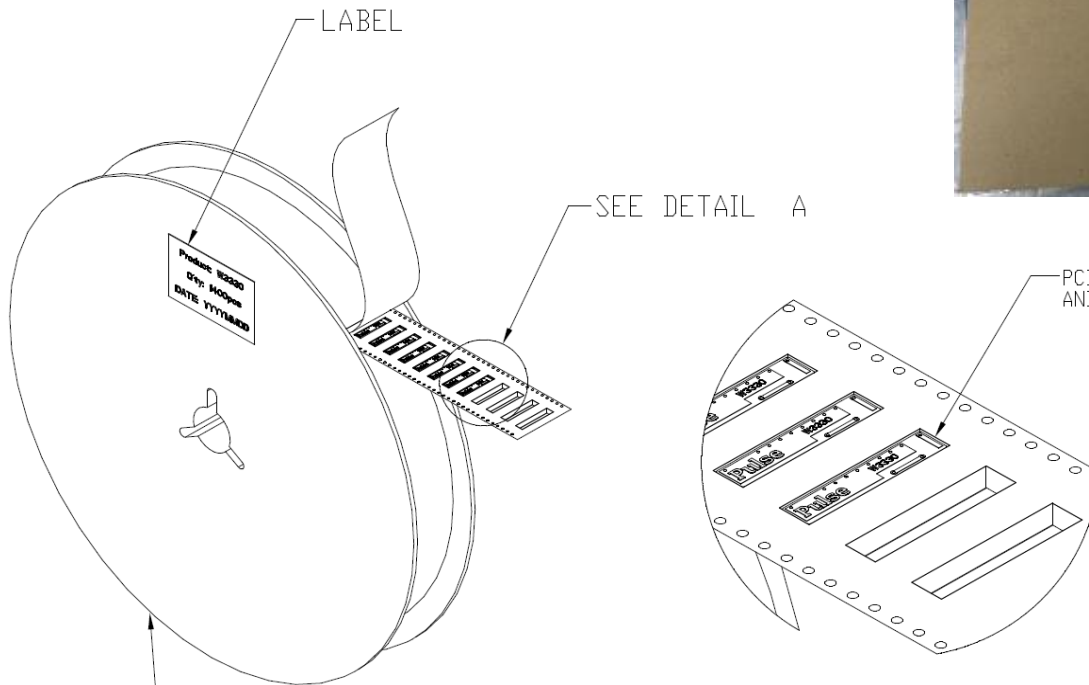
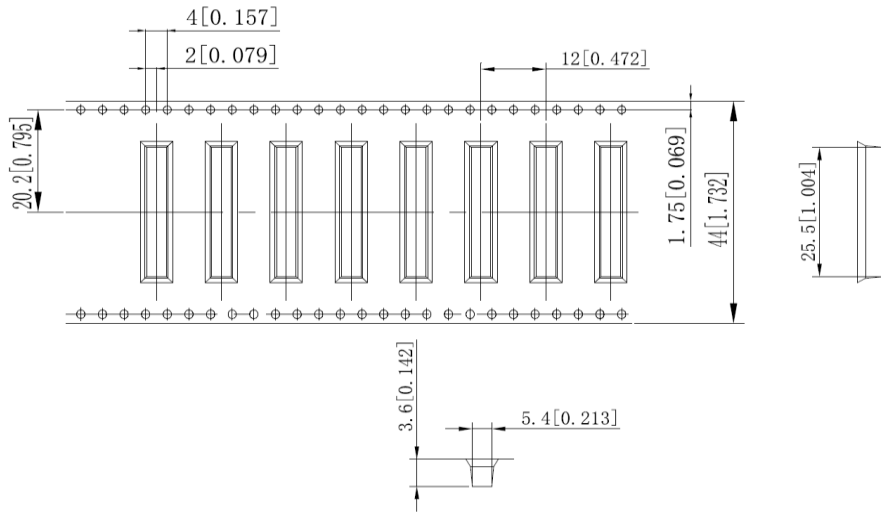

- (1) 13" TAPE & REEL, 1400 PCS/REEL, AND EACH REEL SEALED WITH A VACUUM BAG (075-03363.001)
- (2) 2 PCS TAPE & REEL OF PRODUCTS(TOTAL 2800PCS PRODUCTS) PACKED IN ONE CARTON.

Issue: 2045

In the effort to improve our products, we reserve the right to make changes judged to be necessary.
CONFIDENTIAL AND PROPRIETARY INFORMATION

This document contains confidential and proprietary information of Pulse Electronics, Inc. (Pulse) and is protected by copyright, trade secret and other state and federal laws. Its receipt or possession does not convey any rights to reproduce, disclose its contents, or to manufacture, use or sell anything it may describe. Reproduction, disclosure or use without specific written authorization of Pulse is strictly forbidden.