

## Item description

### Male connector/plug WINSTA® MIDI with protection against mismatching

Use effective pluggable connections instead of laborious screw connections: With the WINSTA® MIDI male connector/plug with protection type IP20. Our pluggable installation connectors with spring pressure connection technology function without screw connections. They allow fast, efficient, error-free installation in numerous possible uses. The mechanical coding and color coding of the pluggable installation connector ensure error-free installation of the individual components – including protection against mismatching. The pluggable installation connector offers touch-proof protection with live components in accordance – with protection type IP20 (When mated and secured with a strain relief housing: IP2xC (These compact connectors are not designed for use in open, easily accessible areas!)). Thanks to the color coding and mechanical A coding of WINSTA®

Subject to changes. Please also observe the further product documentation!



MIDI pluggable installation connectors, you can clearly distinguish different circuits. The rated current and voltage are important criteria for selecting a pluggable installation connector: They provide information about possible domains of use and applications. This product has a current rating of 25 A – so it is suitable for robust loads. Our *WINSTA*® MIDI product line allows total flexibility for the installation of applications. Through its Push-in CAGE CLAMP® spring pressure connection technology, it achieves error-free, time-saving installation and offers customization for meeting various installation requirements. The strip length is 55 mm.

## Push-in CAGE CLAMP® spring pressure connection technology – pluggable installation instead of laborious screw connections!

The *WINSTA*® Pluggable Connection System is perfectly tailored to the very strict requirements of building installation. It makes electrical installation pluggable, and thus faster, even more reliable, and error-free. Use of this pre-assembled system decreases assembly times and installation errors at the construction site. Take advantage of the pluggable version of our maintenance-free spring pressure connection technology too! Plan your installation with *WINSTA*® MIDI pluggable installation connectors with marking from WAGO.

- effective protection against mismatching
- simple circuits
- with A coding for use in a large number of general mains applications
- flexible installation to save space
- quick replacement of defective units during ongoing operation

## Data

### Electrical data

#### Ratings per IEC/EN

Ratings per	IEC/EN 60664-1
Nominal voltage (III/3)	400 V
Rated impulse voltage (III/3)	6 kV
Rated current	25 A
Legend (ratings)	(III / 3) ≙ Overvoltage category III / Pollution degree 3

#### Ratings per UL 1977

Note for the US market	Some versions may also be used for current interruption in accordance with the UL certificate in select applications with currents below 16 A and voltages up to 600 V. For further information, please contact your local sales office.
Rated voltage (UL 1977)	600 V
Rated current UL 1977	23 A

Subject to changes. Please also observe the further product documentation!



## General

Note on contact resistance	approx. 1 mΩ of contact resistance approx. 0.25 mΩ contact transition plug/socket
----------------------------	--

## Connection data

Connection points	8
Total number of potentials	4
PE function	Preceding PE contact

## Connection 1

Connection technology	Push-in CAGE CLAMP®
Actuation type	Operating tool Push-in
Nominal cross-section	4 mm <sup>2</sup> / 12 AWG
Solid conductor	0.5 ... 4 mm <sup>2</sup> / 20 ... 12 AWG
Solid conductor; push-in termination	1.5 ... 4 mm <sup>2</sup> / 16 ... 12 AWG
Stranded conductor	0.5 ... 2.5 mm <sup>2</sup> / 20 ... 14 AWG
Fine-stranded conductor	0.5 ... 4 mm <sup>2</sup> / 20 ... 12 AWG
Fine-stranded conductor; with insulated ferrule	0.25 ... 1.5 mm <sup>2</sup> / 20 ... 16 AWG
Fine-stranded conductor; with uninsulated ferrule	0.25 ... 2.5 mm <sup>2</sup> / 20 ... 14 AWG
Fine-stranded conductor; with ferrule; push-in termination	1.5 mm <sup>2</sup> / 16 AWG
Strip length	9 mm / 0.35 inches
Pole number	4
Connectable sheathed cable diameter	9 ... 13 mm
Conductor entry direction to mating direction	0°
Strip length (outer insulation)	55 mm

## Physical data

Pin spacing	10 mm / 0.394 inches
Width	44.6 mm / 1.756 inches
Height	17 mm / 0.669 inches
Depth	76 mm / 2.992 inches

## Mechanical Data

Application	General mains applications
-------------	----------------------------

Subject to changes. Please also observe the further product documentation!



Coding	A
Variable coding	Yes
Marking	1/L' 2/L' $\perp$ N
Potential marking	1/L' 2/L' $\perp$ N
Mating force of a plug-in connection	approx. 20 ... 70 N (depending on pole number)
Retention force of a plug-in connection	Locked: > 80 N
Unmating force of a plug-in connection	Unlocked: approx. 20 ... 70 N (depending on pole number)
Number of mating cycles	200, without resistive load
Protection type	IP20; When mated and secured with a strain relief housing: IP2xC (These compact connectors are not designed for use in open, easily accessible areas!)

### Plug-in connection

Contact type (pluggable connector)	Male connector/plug
Connector (connection type)	for conductor
Mismating protection	Yes
Note on mismating protection	All WINSTA <sup>®</sup> components are 100% protected against mismating when: a.) plugging different numbers of poles b.) plugging while rotated 180 c.) plugging while laterally staggered d.) plugging one pole
Locking lever	Can be retrofitted
Locking of plug-in connection	locking lever
Note on locking system	All connectors for mounted installations (snap-in versions for lighting fixtures or devices, all types of PCB and distribution connectors) are factory-equipped with locking levers to ensure plugs and sockets are securely locked. Additional locking levers are only required for flying leads (plug/socket).
Strain relief	strain relief housing

### Material Data

Note (material data)	Information on material specifications can be found here
Color	black
Cover color	gray
Material group	I
Insulation material	Polyamide (PA66)
Flammability class per UL94	V0

Subject to changes. Please also observe the further product documentation!

WAGO GmbH & Co. KG  
Hansastr. 27  
32423 Minden  
Phone: +49571 887-0 | Fax: +49571 887-169  
Email: [info.de@wago.com](mailto:info.de@wago.com) | Web: [www.wago.com](http://www.wago.com)

Do you have any questions about our products?  
We are always happy to take your call at +49 (571) 887-44222.

Clamping spring material	Chrome-nickel spring steel (CrNi)
Contact material	Copper or copper alloy; surface-treated
Contact plating	Tin
Fire load	0.619 MJ
Weight	24.9 g

### Environmental requirements

Processing temperature	-5 ... +40 °C
Continuous operating temperature	-35 ... +85 °C
Note on continuous operating temperature	Insulating parts for temperatures ≤ 105 °C

### Commercial data

Product Group	20 (Winsta)
eCl@ss 10.0	27-44-06-05
eCl@ss 9.0	27-44-06-05
ETIM 8.0	EC002560
ETIM 7.0	EC002560
PU (SPU)	25 pcs
Packaging type	box
Country of origin	DE
GTIN	4044918254410
Customs tariff number	85366990990

### Environmental Product Compliance

RoHS Compliance Status	Compliant, No Exemption
------------------------	-------------------------

### Approvals / Certificates

#### General approvals

Logo	Approval	Additional Approval Text	Certificate name
	CCA DEKRA Certification B.V.	EN 61535	71- 123228
	CCA DEKRA Certification B.V.	IEC 61535	NL -84761
	cURus Underwriters Laboratories Inc.	UL 1977	E45171

Subject to changes. Please also observe the further product documentation!





	<b>VDE</b> VDE Prüf- und Zertifizierungsinstitut	EN 61535	40029808
	<b>VDE</b> VDE Prüf- und Zertifizierungsinstitut	EN 61984	40002889



#### Declarations of conformity and manufacturer's declarations

Logo	Approval	Additional Approval Text	Certificate name
	<b>EU-Declaration of Conformity</b> WAGO GmbH & Co. KG	-	-











#### Approvals for marine applications

Logo	Approval	Additional Approval Text	Certificate name
	<b>ABS</b> American Bureau of Shipping	-	19- HG1868589- PDA
	<b>DNV GL</b> Det Norske Veritas, Germanischer Lloyd	-	TAE00001Z6
	<b>LR</b> Lloyds Register	IEC 61984	LR22429487TA

#### Counterpart

	<b>Item no.770-104</b> Socket; with strain relief housing; 4-pole; Cod. A; 4,00 mm <sup>2</sup> ; black	<a href="http://www.wago.com/770-104">www.wago.com/770-104</a>
	<b>Item no.770-204</b> Socket; 4-pole; Cod. A; 4,00 mm <sup>2</sup> ; black	<a href="http://www.wago.com/770-204">www.wago.com/770-204</a>

Subject to changes. Please also observe the further product documentation!

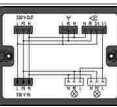
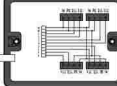
	<b>Item no.770-626</b> T-distribution connector; 4-pole; Cod. A; 1 input; 2 outputs; 2 locking levers; black	<a href="http://www.wago.com/770-626">www.wago.com/770-626</a>
	<b>Item no.770-627</b> T-distribution connector; 4-pole; Cod. A; 1 input; 2 outputs; 3 locking levers; for flying leads; black	<a href="http://www.wago.com/770-627">www.wago.com/770-627</a>
	<b>Item no.770-704</b> Snap-in socket; 4-pole; Cod. A; 4,00 mm <sup>2</sup> ; black	<a href="http://www.wago.com/770-704">www.wago.com/770-704</a>
	<b>Item no.770-704/009-000</b> Snap-in socket; with protruding mating face; 4-pole; Cod. A; 4,00 mm <sup>2</sup> ; black	<a href="http://www.wago.com/770-704/009-000">www.wago.com/770-704/009-000</a>
	<b>Item no.770-804</b> Socket for PCBs; straight; 4-pole; Cod. A; black	<a href="http://www.wago.com/770-804">www.wago.com/770-804</a>
	<b>Item no.770-944</b> h-distribution connector; 4-pole; Cod. A; 1 input; 2 outputs; outputs on one side; 2 locking levers; black	<a href="http://www.wago.com/770-944">www.wago.com/770-944</a>
	<b>Item no.770-804/011-000</b> Socket for PCBs; angled; 4-pole; Cod. A; black	<a href="http://www.wago.com/770-804/011-000">www.wago.com/770-804/011-000</a>
	<b>Item no.771-9994/006-101</b> pre-assembled interconnecting cable; Eca; Socket/plug; 4-pole; Cod. A; H05VV-F 4G 1.5 mm <sup>2</sup> ; 1 m; 1,50 mm <sup>2</sup> ; black	<a href="http://www.wago.com/771-9994/006-101">www.wago.com/771-9994/006-101</a>
	<b>Item no.770-945</b> h-distribution connector; 4-pole; Cod. A; 1 input; 2 outputs; outputs on one side; 3 locking levers; for flying leads; black	<a href="http://www.wago.com/770-945">www.wago.com/770-945</a>
	<b>Item no.771-9994/106-101</b> pre-assembled connecting cable; Eca; Socket/open-ended; 4-pole; Cod. A; H05VV-F 4G 1.5 mm <sup>2</sup> ; 1 m; 1,50 mm <sup>2</sup> ; black	<a href="http://www.wago.com/771-9994/106-101">www.wago.com/771-9994/106-101</a>
	<b>Item no.899-631/180-000</b> Distribution box; Motion/presence detector; 1 input; 5 outputs; Cod. A; MIDI; black	<a href="http://www.wago.com/899-631/180-000">www.wago.com/899-631/180-000</a>
	<b>Item no.899-631/453-000</b> Distribution box; supply cable entry; 4 outputs; Cod. A; MIDI; black	<a href="http://www.wago.com/899-631/453-000">www.wago.com/899-631/453-000</a>

## Required accessories

### Locking levers

Locking system



**Item no.: 770-121**  
Locking lever; for flying leads; for manual operation; white

[www.wago.com/770-121](http://www.wago.com/770-121)

Subject to changes. Please also observe the further product documentation!



**Item no.: 770-131**  
Locking lever; for flying leads; for tool operation; white

[www.wago.com/770-131](http://www.wago.com/770-131)



**Item no.: 770-101**  
Locking lever; for flying leads; for manual operation; black

[www.wago.com/770-101](http://www.wago.com/770-101)



**Item no.: 770-111**  
Locking lever; for flying leads; for tool operation; black

[www.wago.com/770-111](http://www.wago.com/770-111)

## Optional accessories

### Tool

Operating tool



**Item no.: 210-719**  
Operating tool; Blade: 2.5 x 0.4 mm; with a partially insulated shaft

[www.wago.com/210-719](http://www.wago.com/210-719)

### Cover

Cover



**Item no.: 770-360**  
Lockout cap; for plugs; 5-pole; separable; yellow

[www.wago.com/770-360](http://www.wago.com/770-360)



**Item no.: 897-2005**  
Protective cap; Type4; for sockets and plugs; PVC; red

[www.wago.com/897-2005](http://www.wago.com/897-2005)

### Marking accessories

Marker



**Item no.: 770-450/000-002**  
Marker card; Plastic; yellow

[www.wago.com/770-450/000-002](http://www.wago.com/770-450/000-002)



**Item no.: 770-450/000-001**  
Marker card; Plastic; green

[www.wago.com/770-450/000-001](http://www.wago.com/770-450/000-001)



**Item no.: 770-450/000-005**  
Marker card; Plastic; red

[www.wago.com/770-450/000-005](http://www.wago.com/770-450/000-005)

Subject to changes. Please also observe the further product documentation!





**Item no.: 770-450**  
Marker card; Plastic; white



**Item no.: 770-450/000-006**  
Marker card; Plastic; blue

[www.wago.com/770-450/000-006](http://www.wago.com/770-450/000-006)



**Item no.: 770-450/000-012**  
Marker card; Plastic; orange

[www.wago.com/770-450/000-012](http://www.wago.com/770-450/000-012)

## Downloads Documentation

### Bid Text

770-114 X81 - Datei	2019 Feb 19	xml 3.1 kB	Download
770-114 doc - Datei	2015 Jun 8	doc 24.1 kB	Download
ausschreiben.de 770-114		URL	Download

## CAD/CAE-Data

### CAD data

2D/3D Models 770-114	URL	Download
----------------------	-----	----------

### CAE data

EPLAN Data Portal 770-114	URL	Download
WSCAD Universe 770-114	URL	Download
ZUKEN Portal 770-114	URL	Download

Subject to changes. Please also observe the further product documentation!

## Environmental Product Compliance

### Compliance Search

Environmental Product Compliance 770-114

[URL](#)

[Download](#)

Plug; with strain relief housing; 4-pole; Cod. A; 4,00 mm<sup>2</sup>; black

## Installation Notes

### Conductor termination

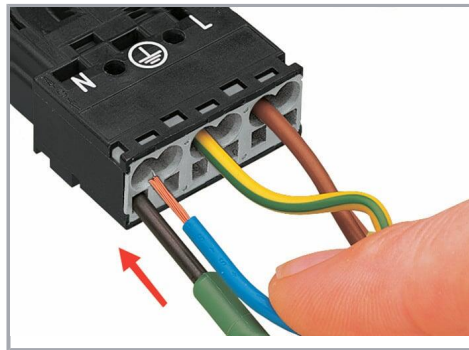
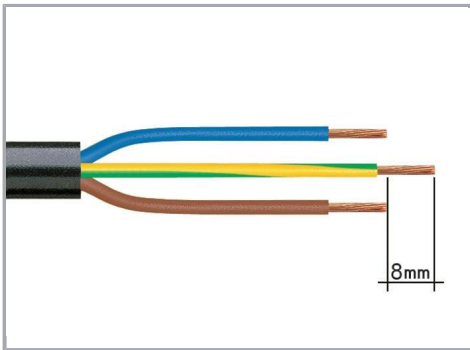

1. Strip length, outer insulation = 35 mm (2-pole), 55 mm (3- to 5-pole)

2. Strip length = 9 mm

3. Extended ground conductor = 8 mm

To terminate fine-stranded conductors, open the clamping unit via screwdriver (2.5 mm blade width) and insert a stripped conductor until it hits the backstop.

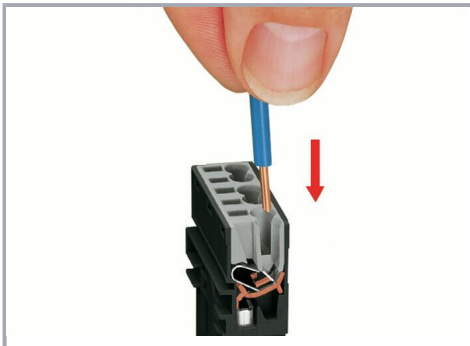

Insert the stripped solid conductor until it hits the backstop.

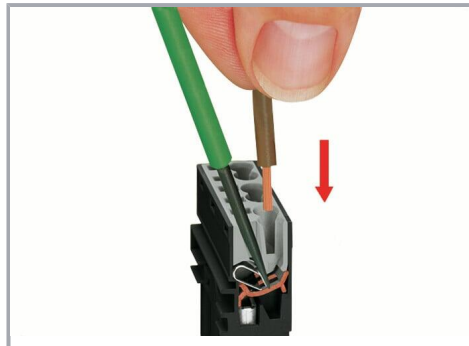

To terminate fine-stranded conductors, open the clamping unit via screwdriver (2.5 mm blade width) and insert a stripped conductor until it hits the backstop.

Subject to changes. Please also observe the further product documentation!

### Conductor removal

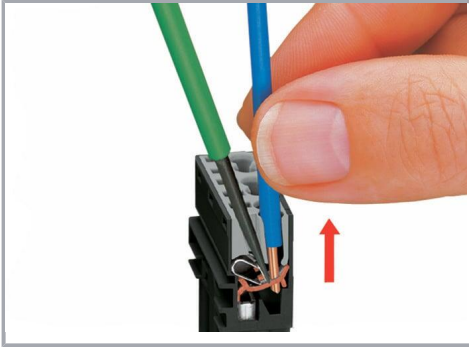

To remove the conductor, actuate the clamp via screwdriver (2.5 mm blade width) and pull out the conductor.

### Installation

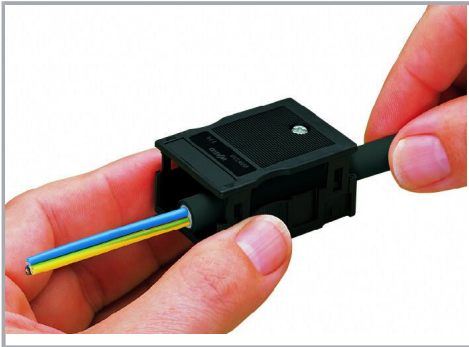

We recommend pulling the pre-latched strain relief housing over the cable prior to termination. However, the strain relief can be mounted at a later time as well.

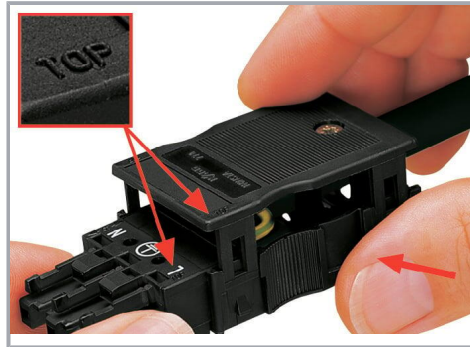

Latch the strain relief housing onto the plug /socket. Note the "TOP" inscription.

Subject to changes. Please also observe the further product documentation!

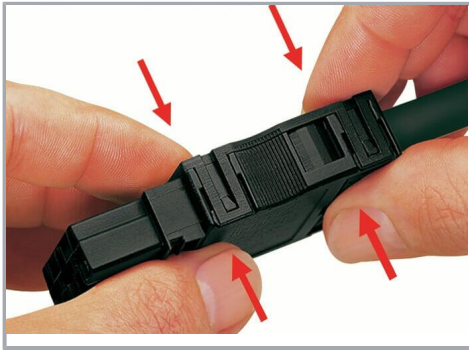

Prepare strain relief housing by snapping together upper and bottom part.



Tighten strain relief screw with screwdriver (2.5 mm blade width).

## Product family

**WINSTA® MIDI**

[Show all products from the family](#)

Subject to changes. Please also observe the further product documentation!