

## TPSM84824 4.5-V to 17-V Input, 0.6-V to 10-V Output, 8-A Power Module

### 1 Features

- Integrated Inductor Power Solution
- 7.5 mm × 7.5 mm × 5.3 mm QFM Package
  - All Pins Accessible From Package Perimeter
- Input Voltage Range: 4.5 V to 17 V
- Wide-Output Voltage Range: 0.6 V to 10 V
- Efficiencies up to 96%
- Adjustable Fixed Switching Frequency (200 kHz to 1.6 MHz)
- Allows Synchronization to an External Clock
- Ultra-Fast Load Step Response (TurboTrans™)
- Power-Good Output
- Meets EN55011 Class B Radiated EMI Limits
- Operating Ambient Range: –40°C to +105°C
- Operating IC Junction Range: –40°C to +150°C
- Create a Custom Design Using the TPSM84824 With the [WEBENCH® Power Designer](#)

### 2 Applications

- Telecom and Wireless Infrastructure
- Industrial Automated Test Equipment
- Enterprise Switching and Storage Applications
- High Density Distributed Power Systems

### 3 Description

The TPSM84824 power module is an easy-to-use integrated power supply that combines an 8-A DC/DC converter with power MOSFETs, a shielded inductor and passives into a small form-factor QFM package. This power solution allows as few as six external components while maintaining the ability to adjust key parameters to meet specific design requirements. Ultra-fast transient response can be achieved by use of the TurboTrans™ feature. TurboTrans allows the transient response to be optimized for reduced output voltage deviation with less required output capacitance.

The 7.5 mm × 7.5 mm × 5.3 mm, 24-pin QFM package is easy to solder to a printed circuit board and has excellent power dissipation capability. The TPSM84824 offers flexibility with many features including power good, programmable UVLO, tracking, prebias start-up, as well as overcurrent and overtemperature protection making it a great product for powering a wide range of devices and systems.

#### Device Information<sup>(1)</sup>

DEVICE NUMBER	PACKAGE	BODY SIZE (NOM)
TPSM84824	QFM (24)	7.50 mm × 7.50 mm

(1) For all available packages, see the orderable addendum at the end of the data sheet.

#### Simplified Schematic

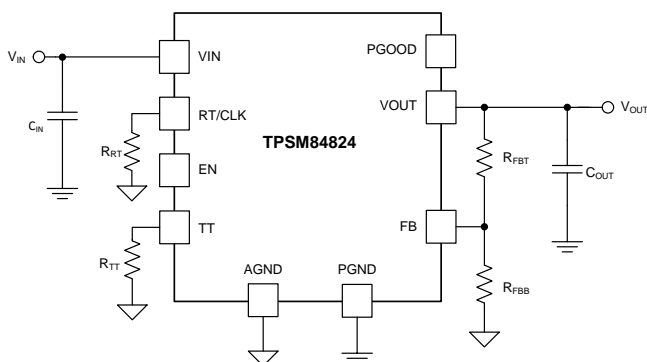

#### Transient Response

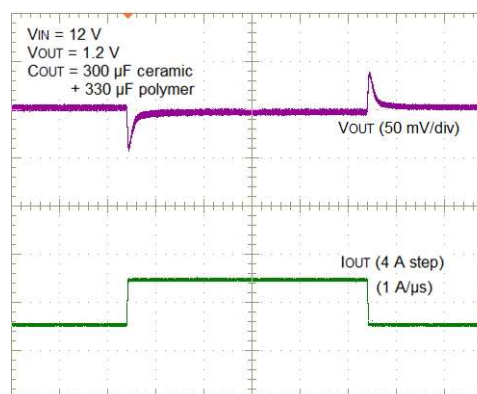

## Table of Contents

<b>1</b>	<b>Features</b> .....	<b>1</b>	<b>8</b>	<b>Application and Implementation</b> .....	<b>21</b>
<b>2</b>	<b>Applications</b> .....	<b>1</b>	8.1	Application Information.....	21
<b>3</b>	<b>Description</b> .....	<b>1</b>	8.2	Typical Application .....	21
<b>4</b>	<b>Revision History</b> .....	<b>2</b>	<b>9</b>	<b>Power Supply Recommendations</b> .....	<b>23</b>
<b>5</b>	<b>Pin Configuration and Functions</b> .....	<b>3</b>	<b>10</b>	<b>Layout</b> .....	<b>24</b>
<b>6</b>	<b>Specifications</b> .....	<b>5</b>	10.1	Layout Guidelines .....	24
6.1	Absolute Maximum Ratings .....	5	10.2	Layout Examples.....	24
6.2	ESD Ratings.....	5	10.3	EMI.....	25
6.3	Recommended Operating Conditions.....	5	10.4	Package Specifications .....	26
6.4	Thermal Information .....	6	<b>11</b>	<b>Device and Documentation Support</b> .....	<b>27</b>
6.5	Electrical Characteristics.....	6	11.1	Device Support .....	27
6.6	Switching Characteristics .....	7	11.2	Receiving Notification of Documentation Updates	27
6.7	Typical Characteristics ( $V_{IN} = 12\text{ V}$ ).....	8	11.3	Community Resources.....	27
6.8	Typical Characteristics ( $V_{IN} = 5\text{ V}$ ).....	9	11.4	Trademarks .....	27
<b>7</b>	<b>Detailed Description</b> .....	<b>10</b>	11.5	Electrostatic Discharge Caution.....	27
7.1	Overview .....	10	11.6	Glossary .....	28
7.2	Functional Block Diagram .....	10	<b>12</b>	<b>Mechanical, Packaging, and Orderable Information</b> .....	<b>28</b>
7.3	Feature Description.....	11	12.1	Tape and Reel Information .....	28
7.4	Device Functional Modes.....	20			

## 4 Revision History

NOTE: Page numbers for previous revisions may differ from page numbers in the current version.

<b>Changes from Revision A (February 2018) to Revision B</b>	<b>Page</b>
• Added inductor value to the block diagram .....	10
• Changed $V_{OUT}$ Range vs Switching Frequency table .....	12
• Added 270 $\mu\text{F}$ capacitor to the Allowable Polymer Capacitor table .....	15
• Added <i>EMI</i> section .....	25

<b>Changes from Original (November 2017) to Revision A</b>	<b>Page</b>
• First release of production-data data sheet .....	1

## 5 Pin Configuration and Functions

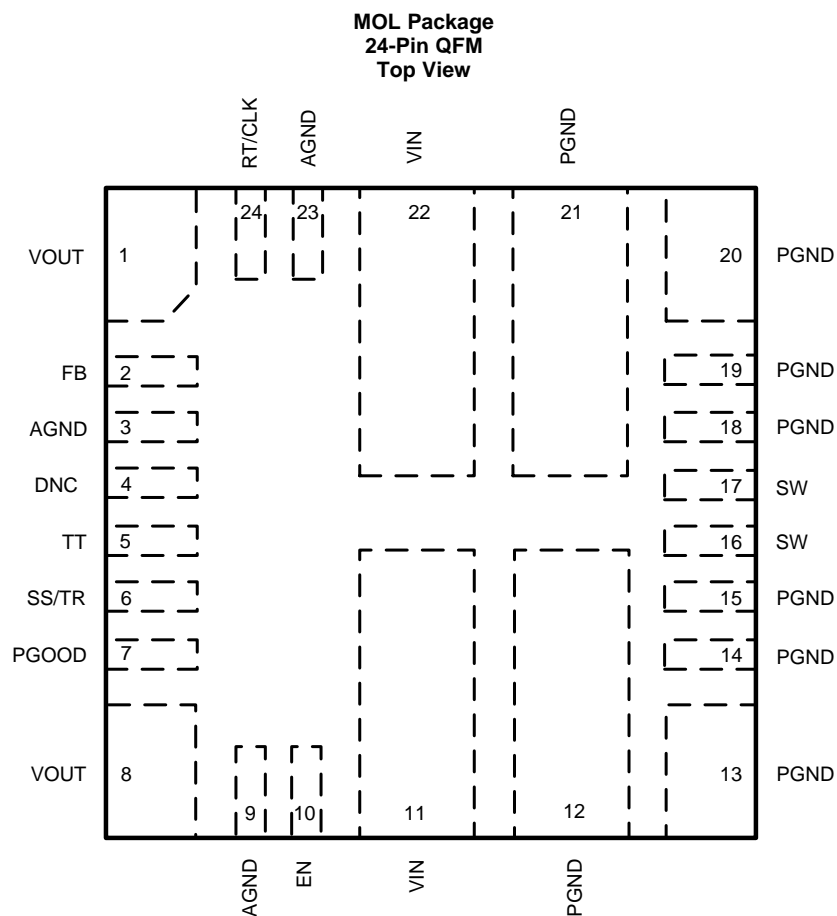

### Pin Functions

PIN		TYPE <sup>(1)</sup>	DESCRIPTION
NAME	NO.		
AGND	3, 9, 23	G	Analog ground. Zero voltage reference for internal references and logic. These pins should be connected to one another externally using an analog ground plane on the PCB. Do not connect this pin to PGND; the connection is made internal to the device.
DNC	4		Do Not Connect. Do not connect this pin to AGND, PGND, or to any other voltage. This pin is connected to internal circuitry.
EN	10	I	Enable. Float or pull high to enable the device. Connect a resistor divider to this pin to implement adjustable undervoltage lockout and hysteresis.
FB	2	I	Feedback input of the regulator. Connect the output voltage feedback resistor divider to this pin.
PGND	12, 13, 14, 15, 18, 19, 20, 21	G	Power ground. This is the return current path for the power stage of the device. Connect these pins to the input source, the load, and to the bypass capacitors associated with VIN and VOUT using power ground planes on the PCB. Pads 12 and 21 should be connected to the ground planes using multiple vias for improved thermal performance.
PGOOD	7	O	Power-Good flag. This open drain output asserts low if the output voltage is outside of the PGOOD thresholds, VIN is lower than its UVLO threshold, EN is low, device is in thermal shutdown or device is in soft-start. Use a 10-kΩ to 100-kΩ pullup resistor to logic rail or other DC voltage no higher than 6.5 V.
RT/CLK	24	I	Switching frequency setting pin. In RT mode, an external timing resistor adjusts the switching frequency. In CLK mode, the device synchronizes to an external clock input to this pin.
SS/TR	6	I	Soft-start and tracking pin. Connecting an external capacitor to this pin adjusts the output voltage soft-start ramp slower than its 1.25-ms default setting. A voltage applied to this pin allows for tracking and sequencing control.

(1) G = Ground, I = Input, O = Output

**Pin Functions (continued)**

PIN		TYPE <sup>(1)</sup>	DESCRIPTION
NAME	NO.		
SW	16, 17	O	Switch node. Do not place any external components on these pins or tie them to a pin of another function.
TT	5	I	TurboTrans pin. Internal loop compensation network. Connect the required TurboTrans resistor between this pin and AGND. See the <a href="#">TurboTrans (TT)</a> section for the value of the resistor. Do not leave this pin floating.
VIN	11, 22	I	Input voltage. Supplies voltage to the power switches of the converter and all of the internal circuitry. Connect these pins to the input source and connect external input capacitors between these pins and PGND, close to the device. These pins should be connected to internal VIN layers using multiple vias for improved thermal performance.
VOUT	1, 8	O	Output voltage. These pins are connected to the internal output inductor. Connect these pins to the output load and connect external output capacitors between these pins and PGND, close to the device. These pins should be connected to internal VOUT layers using multiple vias for improved thermal performance.

## 6 Specifications

### 6.1 Absolute Maximum Ratings

Over operating ambient temperature range (unless otherwise noted)<sup>(1)</sup>

		MIN	MAX	UNIT
Input voltage	V <sub>IN</sub>	-0.3	19	V
	EN, PGOOD, SS/TRK, RT/CLK, FB	-0.3	6.5	V
	AGND to PGND	-0.3	0.3	V
Output voltage	SW	-1	V <sub>IN</sub> + 1	V
	SW (< 10-ns transients)	-3	V <sub>IN</sub> + 3	V
	V <sub>OUT</sub>	-0.3	V <sub>IN</sub>	V
Mechanical shock	Mil-STD-883D, Method 2002.3, 1 msec, 1/2 sine, mounted		500	G
Mechanical vibration	Mil-STD-883D, Method 2007.2, 20 to 2000 Hz		10	G
Operating IC junction temperature, T <sub>J</sub> <sup>(2)</sup>		-40	150	°C
Operating ambient temperature, T <sub>A</sub> <sup>(2)</sup>		-40	105	°C
Storage temperature, T <sub>stg</sub>		-40	150	°C

- (1) Stresses beyond those listed under *Absolute Maximum Ratings* may cause permanent damage to the device. These are stress ratings only, which do not imply functional operation of the device at these or any other conditions beyond those indicated under *Recommended Operating Conditions*. Exposure to absolute-maximum-rated conditions for extended periods may affect device reliability.
- (2) The ambient temperature is the air temperature of the surrounding environment. The junction temperature is the temperature of the internal power IC when the device is powered. Operating below the maximum ambient temperature, as shown in the safe operating area(SOA) curves in the typical characteristics sections, ensures that the maximum junction temperature of any component inside the module is never exceeded.

### 6.2 ESD Ratings

		VALUE	UNIT
V <sub>(ESD)</sub>	Electrostatic discharge	Human-body model (HBM), per ANSI/ESDA/JEDEC JS-001 <sup>(1)</sup>	±1500
		Charged-device model (CDM), per JEDEC specification JESD22-C101 <sup>(2)</sup>	±1250

- (1) JEDEC document JEP155 states that 500-V HBM allows safe manufacturing with a standard ESD control process.
- (2) JEDEC document JEP157 states that 250-V CDM allows safe manufacturing with a standard ESD control process.

### 6.3 Recommended Operating Conditions

Over operating ambient temperature range (unless otherwise noted)

		MIN	MAX	UNIT
Input voltage, V <sub>IN</sub>		4.5 <sup>(1)</sup>	17	V
Output voltage, V <sub>OUT</sub>		0.6	10	V
EN voltage, V <sub>EN</sub>		0	5.5	V
PGOOD pullup voltage, V <sub>PGOOD</sub>			5.5	V
PGOOD sink current, I <sub>PGOOD</sub>			1	mA
RT/CLK voltage range, V <sub>CLK</sub>		0	5.5	V
Output current, I <sub>OUT</sub>		0	8	A
Operating ambient temperature, T <sub>A</sub>		-40	105	°C

- (1) For output voltages 0.6 V to < 5.5 V, the recommended minimum V<sub>IN</sub> is 4.5 V or (V<sub>OUT</sub> + 1 V), whichever is greater. For output voltages 5.5 V to < 9 V, the recommended minimum V<sub>IN</sub> is (V<sub>OUT</sub> + 2 V). For output voltages 9 V to 10 V, the recommended minimum V<sub>IN</sub> is (V<sub>OUT</sub> + 3 V).

## 6.4 Thermal Information

THERMAL METRIC <sup>(1)</sup>		TPSM84824	UNIT
		MOL (QFN)	
		24 PINS	
R <sub>θJA</sub>	Junction-to-ambient thermal resistance <sup>(2)</sup>	22	°C/W
ψ <sub>JT</sub>	Junction-to-top characterization parameter <sup>(3)</sup>	2.1	°C/W
ψ <sub>JB</sub>	Junction-to-board characterization parameter <sup>(4)</sup>	13.6	°C/W

- (1) For more information about thermal metrics, see the [Semiconductor and IC Package Thermal Metrics](#) application report.
- (2) The junction-to-ambient thermal resistance, R<sub>θJA</sub>, applies to devices soldered directly to a 100 mm × 100 mm, 4-layer PCB with 2 oz. copper and natural convection cooling. Additional airflow reduces R<sub>θJA</sub>.
- (3) The junction-to-top board characterization parameter, ψ<sub>JT</sub>, estimates the junction temperature, T<sub>J</sub>, of a device in a real system, using a procedure described in JESD51-2A (section 6 and 7). T<sub>J</sub> = ψ<sub>JT</sub> × P<sub>dis</sub> + T<sub>T</sub>; where P<sub>dis</sub> is the power dissipated in the device and T<sub>T</sub> is the temperature of the top of the device.
- (4) The junction-to-board characterization parameter, ψ<sub>JB</sub>, estimates the junction temperature, T<sub>J</sub>, of a device in a real system, using a procedure described in JESD51-2A (sections 6 and 7). T<sub>J</sub> = ψ<sub>JB</sub> × P<sub>dis</sub> + T<sub>B</sub>; where P<sub>dis</sub> is the power dissipated in the device and T<sub>B</sub> is the temperature of the board 1mm from the device.

## 6.5 Electrical Characteristics

Over –40°C to +105°C ambient temperature, V<sub>IN</sub> = 12 V, V<sub>OUT</sub> = 1.2 V, I<sub>OUT</sub> = I<sub>OUTmax</sub>, f<sub>sw</sub> = 450 kHz (unless otherwise noted); C<sub>IN1</sub> = 2 × 10-μF, 25-V, 1210 ceramic; C<sub>IN2</sub> = 100-μF, 50-V, electrolytic; C<sub>OUT</sub> = 4 × 47-μF, 10-V, 1210 ceramic. Minimum and maximum limits are specified through production test or by design. Typical values represent the most likely parametric norm and are provided for reference only.

PARAMETER		TEST CONDITIONS	MIN	TYP	MAX	UNIT
<b>INPUT VOLTAGE (V<sub>IN</sub>)</b>						
V <sub>IN</sub>	Input voltage	Over I <sub>OUT</sub> range	4.5 <sup>(1)</sup>		17	V
UVLO	V <sub>IN</sub> undervoltage lockout	V <sub>IN</sub> increasing		4.1	4.3	V
		V <sub>IN</sub> decreasing	3.7	3.9		V
I <sub>SHDN</sub>	Shutdown supply current	V <sub>EN</sub> = 0 V		3	11	μA
<b>OUTPUT VOLTAGE (V<sub>OUT</sub>)</b>						
V <sub>OUT(ADJ)</sub>	Output voltage adjust	Over I <sub>OUT</sub> range	0.6		10	V
V <sub>OUT(Ripple)</sub>	Output voltage ripple	20-MHz bandwidth		16		mV
<b>FEEDBACK</b>						
V <sub>FB</sub>	Feedback voltage <sup>(2)</sup>	T <sub>A</sub> = 25°C, I <sub>OUT</sub> = 0 A	0.596	0.6	0.604	V
		–40°C ≤ T <sub>J</sub> ≤ 125°C, I <sub>OUT</sub> = 0 A	0.595	0.6	0.605	V
	Line regulation	Over V <sub>IN</sub> range, T <sub>A</sub> = 25°C, I <sub>OUT</sub> = 0 A		0.1		mV
	Load regulation	Over I <sub>OUT</sub> range, T <sub>A</sub> = 25°C		0.8		mV
<b>CURRENT</b>						
I <sub>OUT</sub>	Output current	Natural convection, T <sub>A</sub> = 25°C	0		8	A
	Overcurrent threshold			11		A
<b>PERFORMANCE</b>						
η	Efficiency	V <sub>IN</sub> = 12 V, I <sub>OUT</sub> = 4 A	V <sub>OUT</sub> = 5 V, f <sub>sw</sub> = 1.2 MHz	94%		
			V <sub>OUT</sub> = 3.3 V, f <sub>sw</sub> = 1.0 MHz	93%		
			V <sub>OUT</sub> = 1.8 V, f <sub>sw</sub> = 600 kHz	91%		
			V <sub>OUT</sub> = 1.2 V, f <sub>sw</sub> = 450 kHz	87%		
			V <sub>OUT</sub> = 1 V, f <sub>sw</sub> = 400 kHz	86%		
	Transient response voltage deviation		25% to 75% load step, 2A/μs slew rate, R <sub>TT</sub> = 6.98 kΩ, C <sub>OUT</sub> = 400-μF ceramic + 220-μF polymer	36		mV
			25% to 75% load step, 2A/μs slew rate, R <sub>TT</sub> = 8.87 kΩ, C <sub>OUT</sub> = 400-μF ceramic	44		mV

- (1) For output voltages 0.6 V to < 5.5 V, the recommended minimum V<sub>IN</sub> is 4.5 V or (V<sub>OUT</sub> + 1 V), whichever is greater. For output voltages 5.5 V to < 9 V, the recommended minimum V<sub>IN</sub> is (V<sub>OUT</sub> + 2 V). For output voltages 9 V to 10 V, the recommended minimum V<sub>IN</sub> is (V<sub>OUT</sub> + 3 V).
- (2) The overall output voltage tolerance will be affected by the tolerance of the external R<sub>FBT</sub> and R<sub>FBB</sub> resistors.

## Electrical Characteristics (continued)

Over  $-40^{\circ}\text{C}$  to  $+105^{\circ}\text{C}$  ambient temperature,  $V_{\text{IN}} = 12\text{ V}$ ,  $V_{\text{OUT}} = 1.2\text{ V}$ ,  $I_{\text{OUT}} = I_{\text{OUTmax}}$ ,  $f_{\text{sw}} = 450\text{ kHz}$  (unless otherwise noted);  $C_{\text{IN1}} = 2 \times 10\text{-}\mu\text{F}$ , 25-V, 1210 ceramic;  $C_{\text{IN2}} = 100\text{-}\mu\text{F}$ , 50-V, electrolytic;  $C_{\text{OUT}} = 4 \times 47\text{-}\mu\text{F}$ , 10-V, 1210 ceramic. Minimum and maximum limits are specified through production test or by design. Typical values represent the most likely parametric norm and are provided for reference only.

PARAMETER		TEST CONDITIONS	MIN	TYP	MAX	UNIT
<b>SOFT START</b>						
$t_{\text{SS}}$	Internal soft start time			1.25		ms
$I_{\text{SS}}$	Soft start charge current			5		$\mu\text{A}$
<b>THERMAL</b>						
$T_{\text{SHDN}}$	Thermal shutdown	Shutdown temperature		170		$^{\circ}\text{C}$
		Hysteresis		15		$^{\circ}\text{C}$
<b>ENABLE (EN)</b>						
$V_{\text{EN-H}}$	EN rising threshold			1.2	1.26	V
$V_{\text{EN-HYS}}$	EN falling threshold		1.1	1.15		V
$I_{\text{EN}}$	EN pin sourcing current	$V_{\text{EN}} = 1.1\text{ V}$		1.2		$\mu\text{A}$
		$V_{\text{EN}} = 1.3\text{ V}$		3.6		$\mu\text{A}$
<b>POWER GOOD (PGOOD)</b>						
$V_{\text{PGOOD}}$	PGOOD thresholds	$V_{\text{OUT}}$ rising (fault)		108%		
		$V_{\text{OUT}}$ falling (good)		106%		
		$V_{\text{OUT}}$ rising (good)		91%		
		$V_{\text{OUT}}$ falling (fault)		89%		
	Minimum $V_{\text{IN}}$ for valid PGOOD	$V_{\text{PGOOD}} < 0.5\text{ V}$ , $I_{\text{PGOOD}} = 2\text{ mA}$		0.7	1	V
	PGOOD low voltage	2-mA pullup, $V_{\text{EN}} = 0\text{ V}$			0.3	V
<b>CAPACITANCE</b>						
$C_{\text{IN}}$	External input capacitance	Ceramic type		20 <sup>(3)</sup>		$\mu\text{F}$
		Non-ceramic type		100 <sup>(3)</sup>		$\mu\text{F}$
$C_{\text{OUT}}$	External output capacitance		min <sup>(4)</sup>		1500 <sup>(5)</sup>	$\mu\text{F}$

- (3) A minimum of 20- $\mu\text{F}$  ceramic input capacitance is required for proper operation. An additional 100  $\mu\text{F}$  of bulk capacitance is recommended for applications with transient load requirements. See the [Input Capacitor](#) section for further guidance.
- (4) The minimum amount of required output capacitance varies depending on the output voltage (see the [Standard Component Values Table](#)). A minimum amount of ceramic output capacitance is required. Locate the capacitance close to the device. Adding additional ceramic or non-ceramic capacitance close to the load improves the response of the regulator to load transients.
- (5) The maximum output capacitance can be made up of all ceramic type or a combination of ceramic and a single non-ceramic type. See the [Low-ESR Output Capacitors Section](#) for requirements of non-ceramic output capacitors.

## 6.6 Switching Characteristics

Over operating ambient temperature range (unless otherwise noted)

Minimum and maximum limits are specified through production test or by design. Typical values represent the most likely parametric norm, and are provided for reference only.

PARAMETER		TEST CONDITIONS	MIN	TYP	MAX	UNIT
<b>SW</b>						
$t_{\text{on\_min}}$	Minimum on-time				140	ns
$t_{\text{off\_min}}$	Minimum off-time				100	ns
<b>FREQUENCY (RT) and SYNCHRONIZATION (EN/SYNC)</b>						
$f_{\text{SW}}$	Default switching frequency	RT pin = 110 k $\Omega$	400	450	500	kHz
	Switching frequency range		200		1600	kHz
$V_{\text{CLK-H}}$	Logic high input voltage		2			V
$V_{\text{CLK-L}}$	Logic low input voltage				0.8	V
$T_{\text{CLK-MIN}}$	Minimum CLK pulse width		35			ns

### 6.7 Typical Characteristics ( $V_{IN} = 12\text{ V}$ )

$T_A = 25^\circ\text{C}$ , unless otherwise noted.

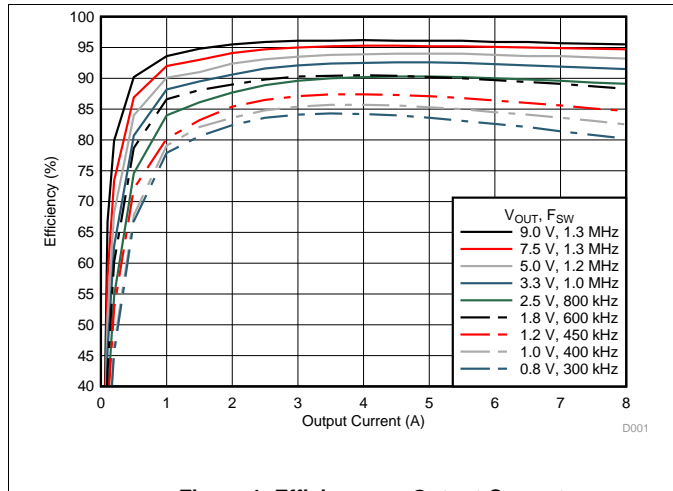

Figure 1. Efficiency vs Output Current

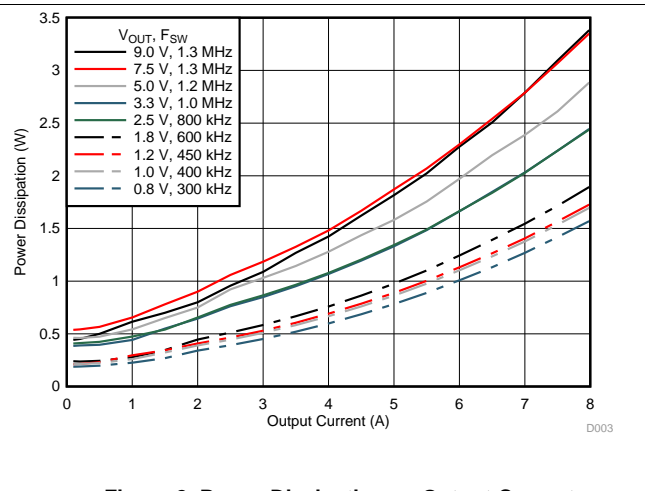

Figure 2. Power Dissipation vs Output Current

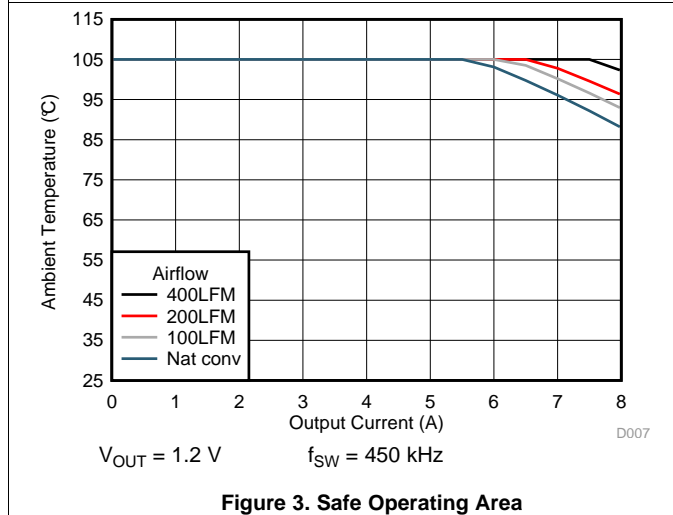

Figure 3. Safe Operating Area

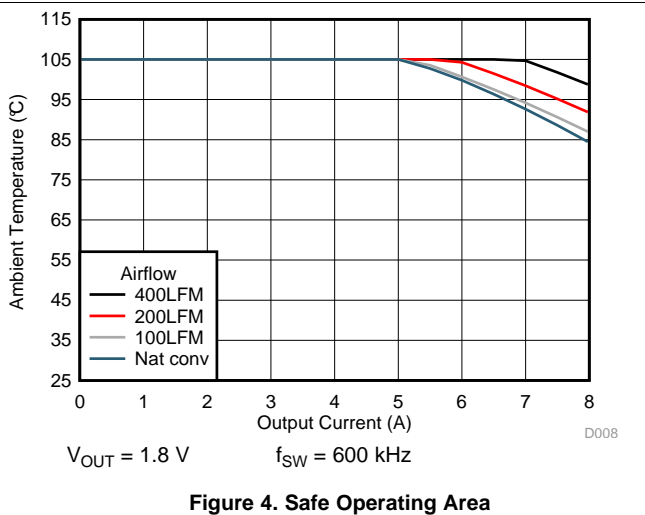

Figure 4. Safe Operating Area

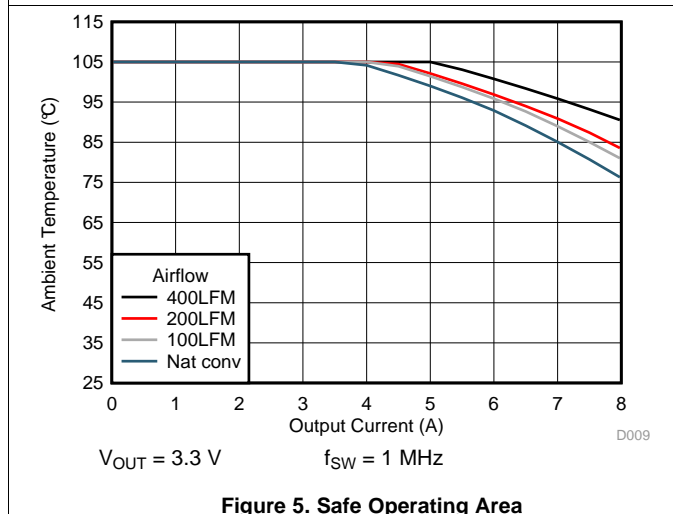

Figure 5. Safe Operating Area

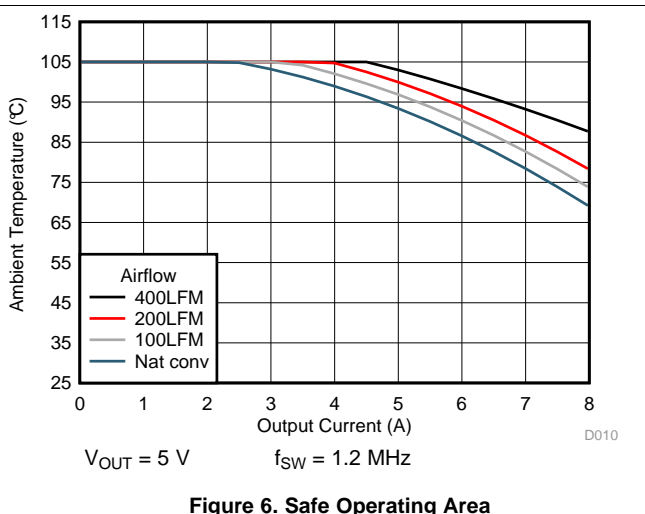
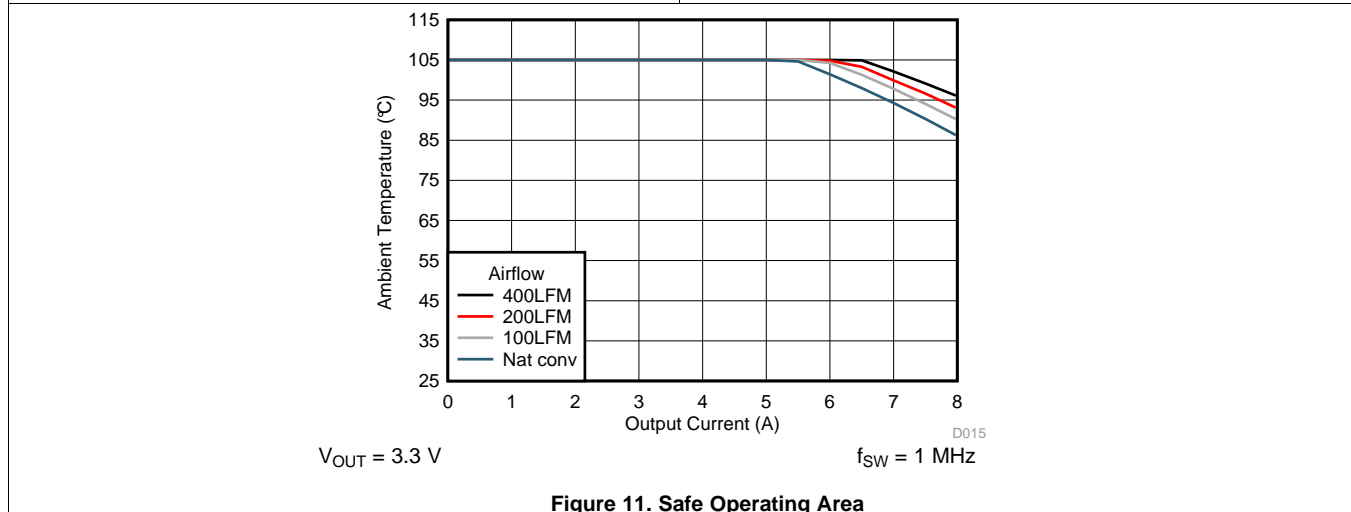
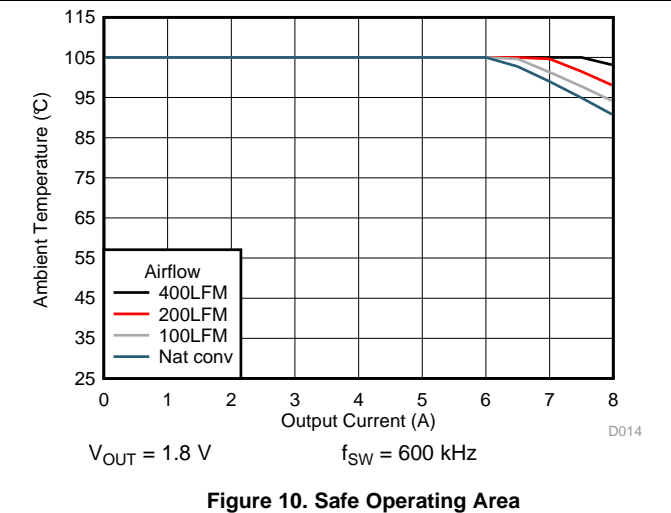
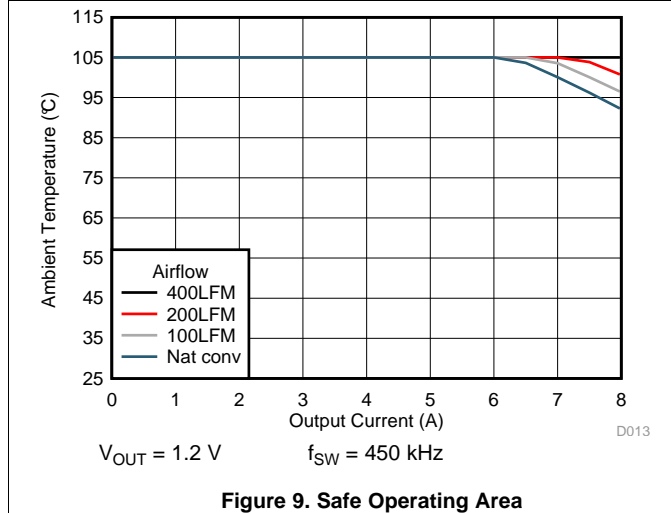
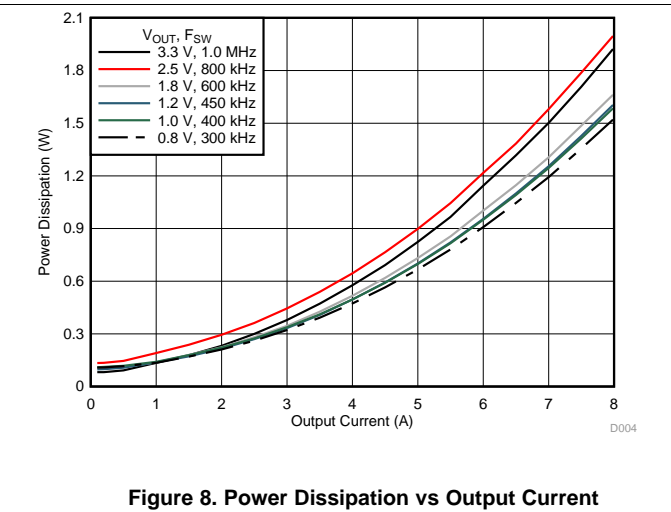
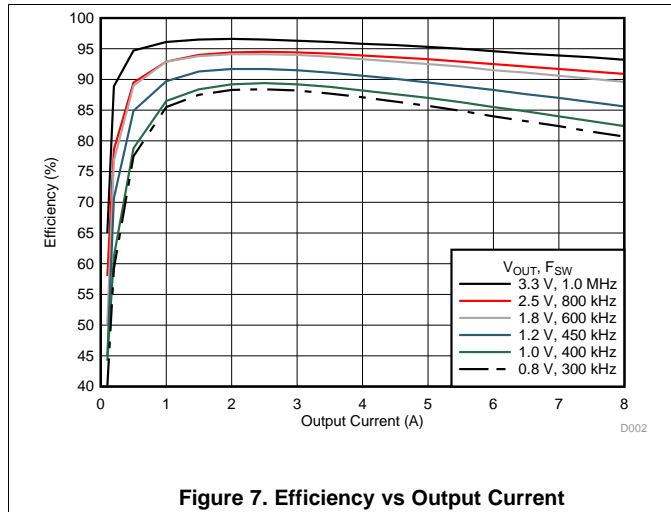

Figure 6. Safe Operating Area



### 6.8 Typical Characteristics ( $V_{IN} = 5\text{ V}$ )

$T_A = 25^\circ\text{C}$ , unless otherwise noted.



## 7 Detailed Description

### 7.1 Overview

The TPSM84824 is a full-featured 4.5-V to 17-V input, 8-A, synchronous step-down converter with PWM, MOSFETs, inductor, and control circuitry integrated into a low-profile package. The device integration enables small designs, while still leaving the ability to adjust key parameters to meet specific design requirements. The TPSM84824 provides an output voltage range of 0.6 V to 10 V. An external resistor divider is used to adjust the output voltage to the desired output. The switching frequency is also adjustable by using an external resistor or a synchronization clock to accommodate various input and output voltage conditions and to optimize efficiency.

The TPSM84824 includes the TurboTrans feature which optimizes the transient response of the converter while simultaneously reducing the quantity of external output capacitors required to meet a target voltage deviation specification.

The TPSM84824 has been designed for safe start-up into pre-biased loads. The default start up is when  $V_{IN}$  is typically 4.1 V. The EN pin has an internal pullup current source that can be used to adjust the input voltage undervoltage lockout (UVLO) with two external resistors. In addition, the internal pullup current of the EN pin allows the device to operate with the EN pin floating. The EN pin can also be pulled low to put the device in standby mode to reduce input quiescent current. The device provides a power-good (PGOOD) signal to indicate when the output voltage is within regulation. Thermal shutdown and current limit features protect the device during an overload condition. A 24-pin QFM package that includes exposed bottom pads provides a thermally enhanced solution for space-constrained applications.

### 7.2 Functional Block Diagram

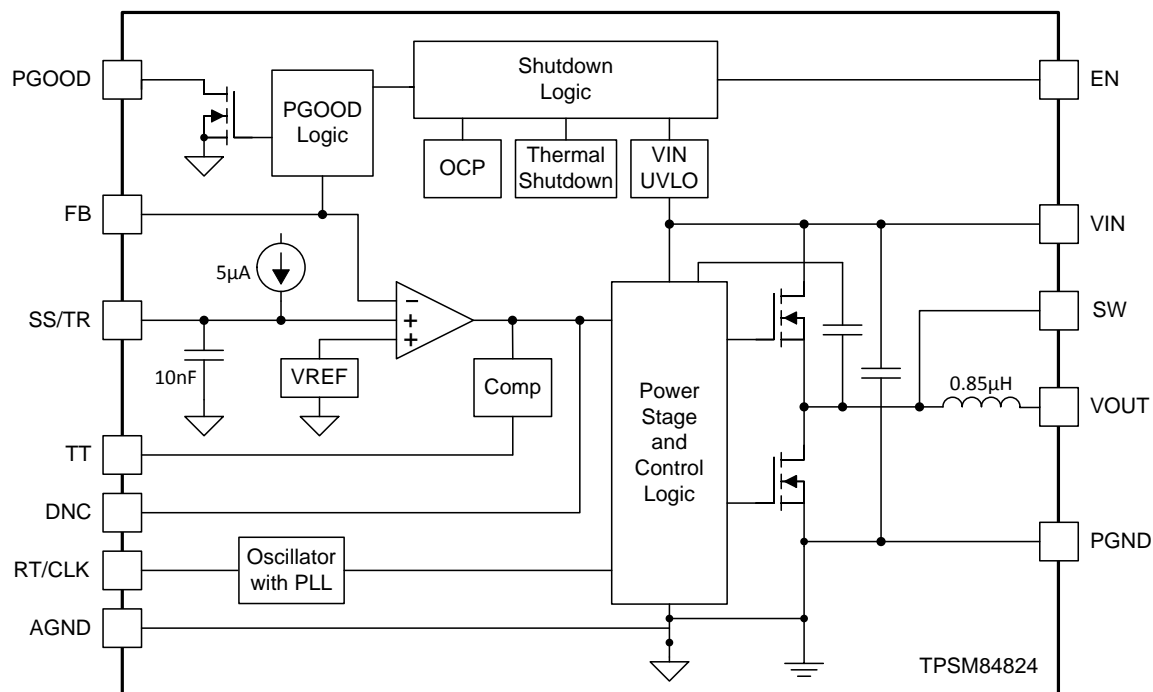

Copyright © 2017, Texas Instruments Incorporated

## 7.3 Feature Description

### 7.3.1 Adjusting the Output Voltage

A resistor divider connected to the FB pin (pin 2) programs the output voltage of the TPSM84824. The output voltage adjustment range is from 0.6 V to 10 V. [Figure 12](#) shows the feedback resistor connection for setting the output voltage. The recommended value of  $R_{FBT}$  is 10 k $\Omega$ . The value for  $R_{FBB}$  can be calculated using [Equation 1](#) or simply selected from the range of values given in [Table 1](#). [Table 1](#) also includes the recommended switching frequency and minimum required output capacitance for each output voltage.

$$R_{FBB} = \frac{6}{(V_{OUT} - 0.6)} \text{ (k}\Omega\text{)} \quad (1)$$

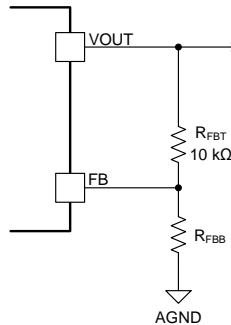

**Figure 12. Setting the Output Voltage**

**Table 1. Standard Component Values**

$V_{OUT}$ (V)	$R_{FBB}$ (k $\Omega$ )	RECOMMENDED $f_{SW}$ (kHz)	$R_{RT}$ (k $\Omega$ )	Minimum Required $C_{OUT}$ ( $\mu$ F) <sup>(1)(2)</sup>	
				CERAMIC	POLYMER <sup>(3)</sup>
0.6	open	250	200	400	220
0.7	60.4	250	200	400	220
0.8	30.1	300	165	300	220
0.9	20.0	350	143	200	220
1.0	15.0	400	124	200	-
1.1	12.1	400	124	200	-
1.2	10.0	450	110	200	-
1.3	8.66	500	97.6	200	-
1.4	7.50	500	97.6	200	-
1.5	6.65	550	88.7	150	-
1.6	6.04	550	88.7	150	-
1.7	5.49	600	82.5	150	-
1.8	4.99	600	82.5	100	-
1.9	4.64	650	75.0	100	-
2.0	4.32	700	69.8	100	-
2.5	3.16	800	60.4	100	-
3.3	2.21	1000	48.7	47	-
5.0	1.37	1200	40.2	47	-
6.0	1.10	1200	40.2	47	-
7.5	0.866	1300	36.5	47	-
9.0	0.715	1300	36.5	22	-
10	0.634	1300	36.5	22	-

(1) Additional capacitance above the minimum can be ceramic or polymer type.

(2) Load transients with > 2 A/ $\mu$ s slew rates or load steps exceeding 4 A may require additional capacitance, see [TurboTrans](#).

(3) See [Low-ESR Output Capacitors](#) for details on polymer capacitors.

### 7.3.2 Switching Frequency (RT)

The switching frequency range of the TPSM84824 is 200 kHz to 1.6 MHz. The switching frequency can easily be set by connecting a resistor ( $R_{RT}$ ) between the RT pin and AGND. Use Equation 2 to calculate the  $R_{RT}$  value for a desired frequency or simply select from Table 2.

The switching frequency must be selected based on the output voltage setting of the device and the operating input voltage. See Table 2 for the allowable output voltage range for a given switching frequency.

$$R_{RT} = 58650 \times f_{SW} (\text{kHz})^{-1.028} (\text{k}\Omega) \quad (2)$$

**Table 2.  $V_{OUT}$  Range vs Switching Frequency**

SWITCHING FREQUENCY	$V_{IN} = 5 \text{ V } (\pm 10\%)$		$V_{IN} = 12 \text{ V } (\pm 5\%)$		$V_{IN} = 15 \text{ V } (\pm 5\%)$	
	$V_{OUT}$ RANGE (V)		$V_{OUT}$ RANGE (V)		$V_{OUT}$ RANGE (V)	
	min	max	min	max	min	max
250 kHz	0.6	0.9	0.6	0.8	0.6	0.8
300 kHz	0.6	0.9	0.6	0.9	0.7	0.9
350 kHz	0.6	1.0	0.7	1.0	0.8	1.0
400 kHz	0.6	1.2	0.7	1.2	0.9	1.2
450 kHz	0.6	1.8	0.8	1.5	1.0	1.5
500 kHz	0.6	2.0	0.9	1.8	1.1	1.8
550 kHz	0.6	2.2	1.0	2.0	1.2	2.0
600 kHz	0.6	2.5	1.1	2.5	1.4	2.3
650 kHz	0.6	3.0	1.2	2.7	1.5	2.5
700 kHz	0.6	3.5	1.3	3.0	1.6	2.8
750 kHz	0.6	3.5	1.4	3.3	1.7	3.0
800 kHz	0.7	3.5	1.5	3.6	1.8	3.3
900 kHz	0.7	3.5	1.6	4.0	2.0	4.0
1.0 MHz	0.9	3.5	1.8	6.0	2.2	4.8
1.1 MHz	1	3.5	2.0	9.0	2.5	6.0
1.2 MHz	1.1	3.5	2.2	9.0	2.7	8.0
1.3 MHz	1.1	3.5	2.3	9.0	2.9	10
1.4 MHz	1.2	3.5	2.4	9.0	3.1	10
1.5 MHz	1.3	3.5	2.6	9.0	3.3	10
1.6 MHz	1.4	3.5	2.8	9.0	3.5	10

### 7.3.3 Synchronization (CLK)

The TPSM84824 switching frequency can also be synchronized to an external clock from 200 kHz to 1.6 MHz. Not all  $V_{IN}$ ,  $V_{OUT}$ , and  $I_{OUT}$  conditions can be set to all of the frequencies in this range due to on-time or off-time limitations. See Table 2 for the allowable operating ranges.

An internal Phase Locked Loop (PLL) has been implemented to allow synchronization and to easily switch from RT mode to CLK mode. To implement the synchronization feature, connect a square wave clock signal to the RT/CLK pin (pin 24) with a duty cycle from 20% to 80%. The clock signal amplitude must transition lower than 0.8 V and higher than 2 V. The start of the switching cycle is synchronized to the falling edge of the RT/CLK pin.

Before the external clock is present the device operates in RT mode and the switching frequency is set by the RT resistor,  $R_{RT}$ . Select  $R_{RT}$  to set the frequency close to the external synchronization frequency. When the external clock is present, the CLK mode overrides the RT mode. The first time the CLK pin is pulled above the RT/CLK high threshold (2 V), the device switches from the RT mode to the CLK mode and the RT/CLK pin becomes high impedance as the PLL starts to lock onto the frequency of the external clock.

During operation, if the external clock is removed, the internal clock frequency begins to drop. After 10  $\mu\text{s}$  without receiving a clock pulse, the device returns to RT mode. Output undershoot can occur while the switching frequency drops and returns to the frequency set by the RT resistor.

### 7.3.4 Output On/Off Enable (EN)

The EN pin provides electrical ON/OFF control of the device. Once the EN pin voltage exceeds the threshold voltage, the device starts operation. If the EN pin voltage is pulled below the threshold voltage, the regulator stops switching and enters low operating current state. The EN pin has an internal pullup current source allowing the user to float the EN pin for enabling the device.

If an application requires controlling the EN pin, either drive it directly with a logic input or use an open drain/collector device to interface with the pin. Applying a low voltage to the enable control (EN) pin disables the output of the supply, shown in Figure 13. When the EN pin voltage exceeds the threshold voltage, the supply executes a soft-start power-up sequence, as shown in Figure 14.

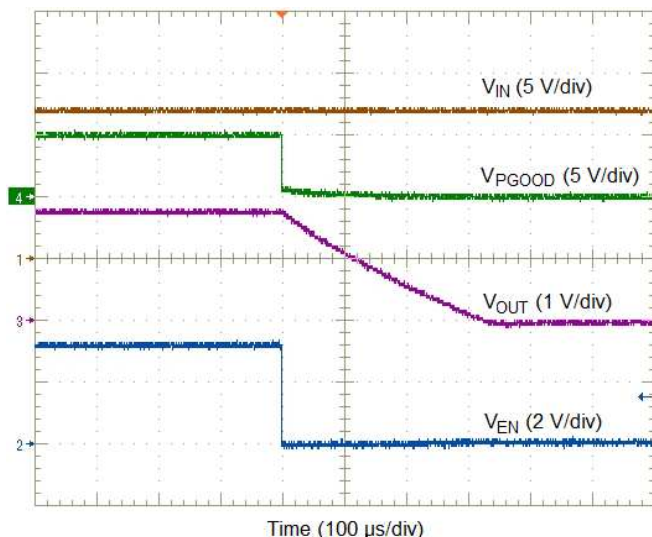

Figure 13. Enable Turnoff

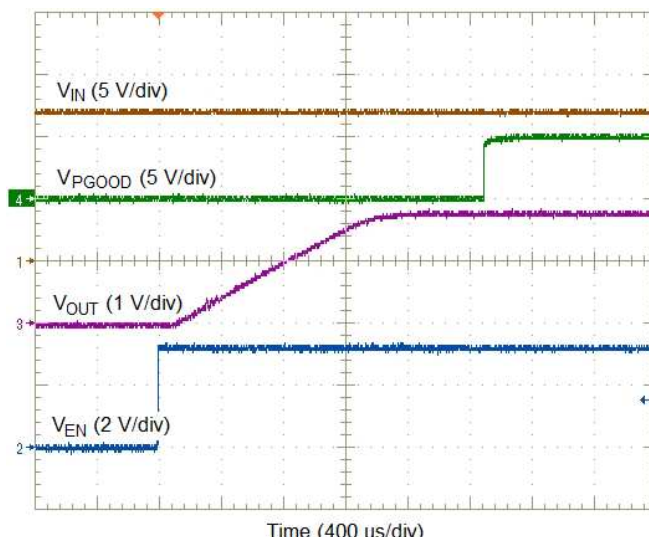

Figure 14. Enable Turnon

### 7.3.5 Input Capacitor Selection

The TPSM84824 requires a minimum input capacitance of 20  $\mu\text{F}$  of ceramic type. Use only high-quality ceramic type X5R or X7R capacitors with sufficient voltage rating. TI recommends an additional 100  $\mu\text{F}$  of non-ceramic capacitance for applications with transient load requirements. The voltage rating of input capacitors must be greater than the maximum input voltage. To compensate the derating of ceramic capacitors, a voltage rating of twice the maximum input voltage is recommended. At worst case, when operating at 50% duty cycle and maximum load, the combined ripple current rating of the input capacitors must be at least 4 A(rms). Table 3 includes a preferred list of capacitors by vendor.

Table 3. Recommended Input Capacitors<sup>(1)</sup>

VENDOR	SERIES	PART NUMBER	CAPACITOR CHARACTERISTICS		
			WORKING VOLTAGE (V)	CAPACITANCE <sup>(2)</sup> ( $\mu\text{F}$ )	ESR <sup>(3)</sup> (m $\Omega$ )
TDK	X7R	C3225X7R1E106K250AC	25	10	2
Murata	X7R	GRM32DR71E106KA12L	25	10	2
Panasonic	ZA	EEHZA1H101P	50	100	28
Panasonic	FC	EEUFC1H101B	50	100	162

- (1) **Capacitor Supplier Verification, RoHS, Lead-free and Material Details**  
Consult capacitor suppliers regarding availability, material composition, RoHS and lead-free status, and manufacturing process requirements for any capacitors identified in this table.
- (2) Specified capacitance values.
- (3) Maximum ESR @ 100 kHz, 25°C.

### 7.3.6 Output Capacitor Selection

The minimum required output capacitance of the TPSM84824 is a function of the output voltage and is shown in [Table 1](#). The required capacitance can be comprised of all ceramic capacitors or a combination of ceramic and low-ESR polymer type capacitors. When adding additional capacitors, low-ESR capacitors like the ones recommended in [Low-ESR Output Capacitors](#) are required. The required capacitance above the minimum is determined by actual transient deviation requirements. See [TurboTrans \(TT\)](#) for typical transient response values for several output voltage and capacitance combinations. See [Table 4](#) for recommended output capacitors.

**Table 4. Recommended Output Capacitors<sup>(1)</sup>**

VENDOR	SERIES	PART NUMBER	CAPACITOR CHARACTERISTICS		
			WORKING VOLTAGE (V)	CAPACITANCE <sup>(2)</sup> (μF)	ESR <sup>(3)</sup> (mΩ)
TDK	X7R	C3225X7R1C226K	16	22	2
Murata	X7R	GCJ32ER71C226K	16	22	2
TDK	X5R	C3225X5R1C226M	16	22	2
Murata	X5R	GRM32ER61C226K	16	22	2
Murata	X7R	GCM32ER70J476K	6.3	47	2
Taiyo Yuden	X7R	LMK325B7476MM-PR	10	47	2
Murata	X7R	GRM32ER71A476K	10	47	2
Murata	X5R	GRM32ER61C476K	16	47	3
TDK	X5R	C3225X5R0J107M	6.3	100	2
Murata	X5R	GRM32ER60J107M	6.3	100	2
Murata	X5R	GRM32ER61A107M	10	100	2
Murata	X6S	GRM32EC80G227ME05L	4.0	220	2
Panasonic	POSCAP	4TPE220MF	4.0	220	15
Kemet	T520	T520D227M006ATE015	6.3	220	15
Panasonic	POSCAP	6TPE330MAA	6.3	330	10
Kemet	T520	T520D337M006ATE010	6.3	330	10
Kemet	T520	T520X337M010ATE010	10	330	10

**(1) Capacitor Supplier Verification, RoHS, Lead-free and Material Details**

Consult capacitor suppliers regarding availability, material composition, RoHS and lead-free status, and manufacturing process requirements for any capacitors identified in this table.

(2) Specified capacitance values.

(3) Maximum ESR @ 100 kHz, 25°C.

### 7.3.7 TurboTrans (TT)

The TPSM84824 includes the TurboTrans feature which optimizes the transient response of the converter while simultaneously reducing the quantity of external output capacitors required to meet a target voltage deviation specification. A TurboTrans resistor,  $R_{TT}$ , is required between the TT pin and AGND to properly set the response of the TPSM84824 based on the amount and type of output capacitors. The value of  $R_{TT}$  can be calculated using Equation 3. In order to calculate the  $R_{TT}$  value, a TurboTrans constant,  $K_{TT}$ , is required. See Table 5 for the  $K_{TT}$  value when using only ceramic output capacitors. See Table 6 for the  $K_{TT}$  value when using a combination of ceramic and polymer output capacitors. Applications operating from input voltages above 14 V, must reduce the calculated  $R_{TT}$  value by 20%. Also, the value of  $C_O$  used in Equation 3 is the total **effective** output capacitance, which takes into account the effects of applied voltage and temperature.

$$R_{TT} = \left[ \left( \frac{K_{TT} \times V_{OUT} \times C_{O(eff)} (\mu F)}{50} \right) - 2 \right] (k\Omega) \quad (3)$$

**Table 5.  $K_{TT}$  Values (Ceramic Only Output Capacitors)**

$V_{OUT}$ (V)	1 - < 1.2	1.2 - < 1.5	1.5 - < 1.8	1.8 - < 2	2 - < 2.5	2.5 - < 3.3	3.3 - < 7.5	7.5 - 10
$K_{TT}$	1	1.12	1.4	1.5	1.65	1.8	2.0	2.25

**Table 6.  $K_{TT}$  Values (Ceramic + Polymer Output Capacitors)**

$V_{OUT}$ (V)	0.6 - < 0.7	0.7 - < 0.9	0.9 - < 1	1 - < 2.5	2.5 - < 3.3	3.3 - < 5	5 - < 6	6 - < 7.5	7.5 - 10
$K_{TT}$	0.6	0.65	0.7	0.6	0.72	0.9	1.2	1.5	1.8

#### 7.3.7.1 Low-ESR Output Capacitors

When selecting non-ceramic output capacitors, the quality of the capacitor is important to maintain stable operation and optimize transient performance. The capacitance rating and the ESR rating are important when selecting these capacitors. Polymer type capacitors with capacitance and ESR in the range shown in Table 7 are required. Capacitors with lower ESR than the minimum listed in Table 7 can be used, however using capacitors with an ESR in the range listed will provide optimal transient performance.

If using a combination of ceramic and polymer type of output capacitance, only a **single** polymer capacitor can be used. Depending on the output voltage setting, only capacitors that meet the specifications listed in Table 7 can be used.

**Table 7. Allowable Polymer Capacitor**

$V_{OUT}$ RANGE	Capacitance ( $\mu F$ )	ESR ( $m\Omega$ )	
		min	max
0.6 V to < 3.3 V <sup>(1)</sup>	220	12	15
	270	9	12
	330 <sup>(1)</sup>	7	10
3.3 V to $\leq$ 10 V	150	15	25
	220	12	15
	270	9	12
	330	7	10

(1) Applications operating at input voltages > 15 V, output voltages < 3.3V, and temperatures below 0°C, the 330- $\mu F$  capacitor is not recommended.

### 7.3.7.2 Transient Response

The TPSM84824 transient response is listed in [Table 8](#) for several common output voltages with different capacitor combinations. The calculated  $R_{TT}$  value is included in the table along with the typical voltage deviation for a 2 A and 4 A load step. All data was taken at the recommended switching frequency for each output voltage.

**Table 8. Output Voltage Transient Response**

$V_{IN} = 12\text{ V}$ , $C_{IN1} = 2 \times 10\ \mu\text{F Ceramic}$ , $C_{IN2} = 100\ \mu\text{F Electrolytic}$ , $T_A = 25^\circ\text{C}$					
$V_{OUT}$ (V)	$C_{OUT1}$ Ceramic	$C_{OUT2}$ BULK	$R_{TT}$ (k $\Omega$ )	VOLTAGE DEVIATION	
				2 A LOAD STEP	4 A LOAD STEP
0.8 <sup>(1)</sup>	300 $\mu\text{F}$	220 $\mu\text{F}$	3.4	22 mV (2.7%)	45 mV (5.6%)
	400 $\mu\text{F}$	330 $\mu\text{F}$	5.36	18 mV (2.2%)	36 mV (4.5%)
1 <sup>(1)</sup>	200 $\mu\text{F}$	-	2.00	30 mV (3.0%)	60 mV (6%)
	200 $\mu\text{F}$	220 $\mu\text{F}$	3.01	22 mV (2.2%)	45 mV (4.5%)
	400 $\mu\text{F}$	-	6.04	21 mV (2.1%)	43 mV (4.3%)
	400 $\mu\text{F}$	220 $\mu\text{F}$	5.49	20 mV (2.0%)	40 mV (4%)
1.2 <sup>(1)</sup>	200 $\mu\text{F}$	-	3.40	35 mV (2.9%)	70 mV (5.8%)
	200 $\mu\text{F}$	220 $\mu\text{F}$	4.02	27 mV (2.3%)	55 mV (4.6%)
	400 $\mu\text{F}$	-	8.87	22 mV (1.8%)	44 mV (3.7%)
	400 $\mu\text{F}$	220 $\mu\text{F}$	6.98	18 mV (1.5%)	36 mV (3%)
1.8 <sup>(1)</sup>	100 $\mu\text{F}$	-	3.40	56 mV (3.1%)	120 mV (6.7%)
	300 $\mu\text{F}$	-	14.3	22 mV (1.2%)	45 mV (2.5%)
	100 $\mu\text{F}$	220 $\mu\text{F}$	4.87	24 mV (1.3%)	52 mV (2.9%)
3.3 <sup>(2)</sup>	100 $\mu\text{F}$	-	8.66	60 mV (1.8%)	122 mV (3.7%)
	100 $\mu\text{F}$	220 $\mu\text{F}$	31.6	32 mV (1.0%)	60 mV (1.8%)
	200 $\mu\text{F}$	-	19.1	43 mV (1.3%)	81 mV (2.5%)
5 <sup>(2)</sup>	100 $\mu\text{F}$	-	10.0	83 mV (1.7%)	162 mV (3.2%)
	100 $\mu\text{F}$	220 $\mu\text{F}$	31.6	32 mV (0.6%)	60 mV (1.2%)
	200 $\mu\text{F}$	-	22.1	48 mV (1.0%)	90 mV (1.8%)
7.5 <sup>(2)</sup>	100 $\mu\text{F}$	-	10.5	112 mV (1.5%)	212 mV (2.8%)
	47 $\mu\text{F}$	220 $\mu\text{F}$	28.0	36 mV (0.5%)	72 mV (1%)

(1) Load step slew rate of 2 A/ $\mu\text{s}$

(2) Load step slew rate of 1 A/ $\mu\text{s}$



7.3.7.2.1 Transient Waveforms ( $V_{IN} = 12\text{ V}$ )

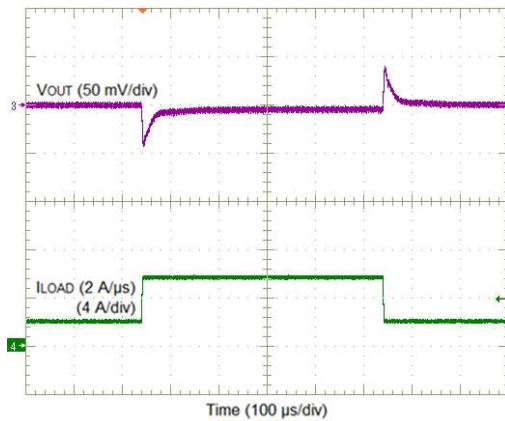

$V_{OUT} = 0.8\text{ V}$   $C_{OUT} = 300\text{ }\mu\text{F ceramic} + 330\text{ }\mu\text{F polymer}$

Figure 15.  $V_{OUT} = 0.8\text{ V}$ , 4-A Load Step

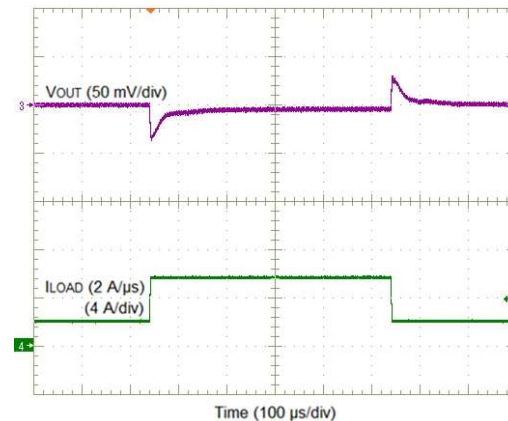

$V_{OUT} = 0.8\text{ V}$   $C_{OUT} = 400\text{ }\mu\text{F ceramic} + 330\text{ }\mu\text{F polymer}$

Figure 16.  $V_{OUT} = 0.8\text{ V}$ , 4-A Load Step

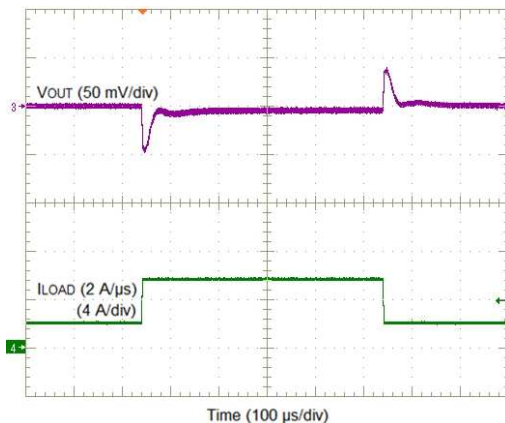

$V_{OUT} = 1\text{ V}$   $C_{OUT} = 200\text{ }\mu\text{F ceramic} + 220\text{ }\mu\text{F polymer}$

Figure 17.  $V_{OUT} = 1\text{ V}$ , 4-A Load Step

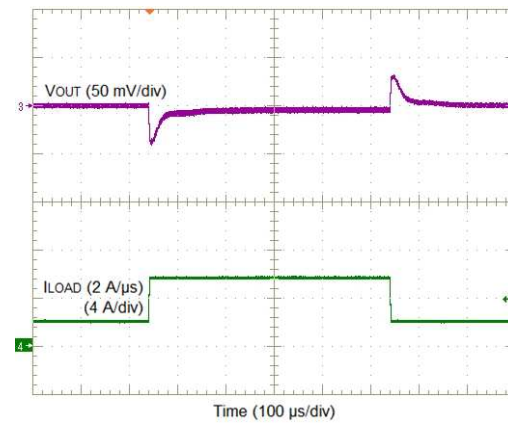

$V_{OUT} = 1\text{ V}$   $C_{OUT} = 400\text{ }\mu\text{F ceramic} + 220\text{ }\mu\text{F polymer}$

Figure 18.  $V_{OUT} = 1\text{ V}$ , 4-A Load Step

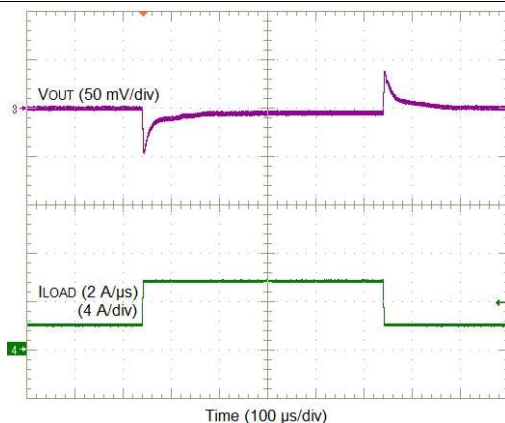

$V_{OUT} = 1.2\text{ V}$   $C_{OUT} = 400\text{ }\mu\text{F ceramic}$

Figure 19.  $V_{OUT} = 1.2\text{ V}$ , 4-A Load Step

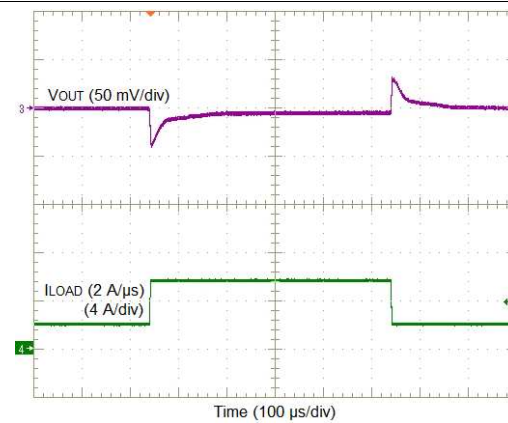

$V_{OUT} = 1.2\text{ V}$   $C_{OUT} = 400\text{ }\mu\text{F ceramic} + 220\text{ }\mu\text{F polymer}$

Figure 20.  $V_{OUT} = 1.2\text{ V}$ , 4-A Load Step

### 7.3.8 Undervoltage Lockout (UVLO)

The TPSM84824 implements internal UVLO circuitry on the VIN pin. The device is disabled when the VIN pin voltage falls below the internal VIN UVLO threshold. The internal VIN UVLO rising threshold is 4.1 V (typical) with a typical hysteresis of 200 mV.

Applications may require a higher UVLO threshold to prevent early turnon, for sequencing requirements, or to prevent input current draw at lower input voltages. An external resistor divider can be added to the EN pin to adjust the UVLO threshold higher. The external resistor divider can be configured as shown in Figure 21. Table 9 lists standard values for R<sub>UVLO1</sub> and R<sub>UVLO2</sub> to adjust the UVLO voltage higher.

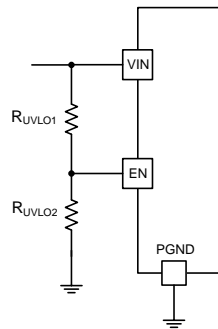

Figure 21. Adjustable UVLO

Table 9. Standard Resistor Values for Adjusting UVLO

VIN UVLO (V)	4.5	5	6	7	8	9	10	11	12
R <sub>UVLO1</sub> (kΩ)	68.1	68.1	68.1	68.1	68.1	68.1	68.1	68.1	68.1
R <sub>UVLO2</sub> (kΩ)	24.3	21.5	16.9	14	12.1	10.5	9.31	8.45	7.50
Hysteresis (mV)	385	400	430	465	500	530	565	600	640

### 7.3.9 Soft Start (SS/TR)

Leaving SS/TR pin open enables the internal soft-start time interval of approximately 1.25 ms. Adding additional capacitance between the SS pin and AGND increases the soft-start time. Increasing the soft-start time reduces inrush current seen by the input source and reduces the current seen by the device when charging the output capacitors. To avoid the activation of current limit and ensure proper start-up, the SS capacitor may need to be increased when operating near the maximum output capacitance limit.

See Table 10 for several SS capacitor values and timing interval or use Equation 4 to calculate the value.

$$t_{SS} = \frac{0.6V \times (C_{SS} + 10nF)}{5 \mu A} \tag{4}$$

Table 10. Soft-Start Capacitor Values and Soft-Start Time

C <sub>SS</sub> (nF)	open	10	15	22	47
SS Time (ms)	1.25	2.4	3	3.8	6.8

During soft-start, the output voltage increases from its starting voltage and rises into regulation. The device is allowed to skip pulses as needed whenever the application conditions exceed the minimum on-time of the device. This behavior is a function of input voltage, output voltage, switching frequency, and load current. During the initial rise of the output voltage, adding an additional non-ceramic output capacitor in parallel with the required ceramic capacitance will improve the output voltage ramp-up.

**NOTE**

When testing soft start performance with an electronic load, the output voltage noise can be exaggerated due to the control loop of the load. Testing with a pure resistive load is a better way to quantify the device performance.

### 7.3.10 Sequencing (SS/TR)

Many of the common power supply sequencing methods can be implemented using the SS/TR, EN and PGOOD pins. The sequential method is illustrated in Figure 22 using two TPSM84824 devices. The PGOOD pin of the first device is coupled to the EN pin of the second device which enables the second power supply once the primary supply reaches regulation.

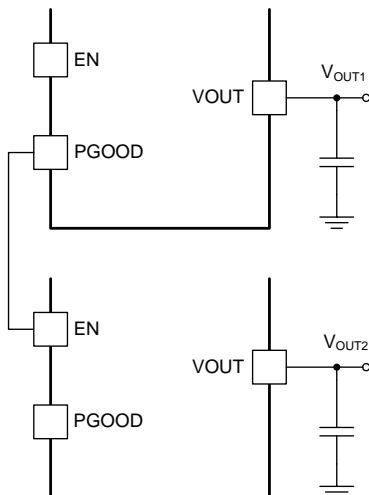

Figure 22. Sequencing Schematic

Simultaneous power supply sequencing can be implemented by connecting the resistor network of R1 and R2 shown in Figure 23 to the output of the power supply that needs to be tracked or to another voltage reference source. Use Equation 5 and Equation 6 to calculate the values of R1 and R2.

$$R1 = \frac{(V_{OUT2} \times 5)}{0.6} \text{ (k}\Omega\text{)} \tag{5}$$

$$R2 = \frac{0.6 \times R1}{(V_{OUT2} - 0.6)} \text{ (k}\Omega\text{)} \tag{6}$$

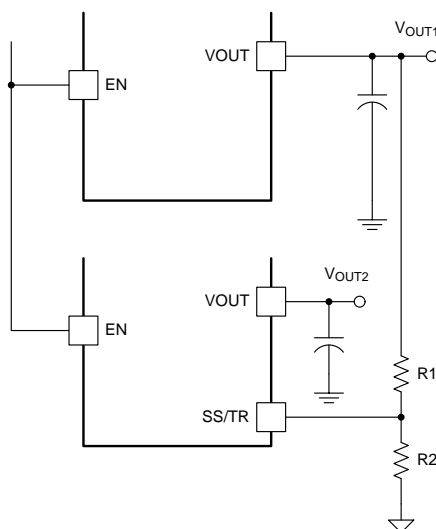

Figure 23. Simultaneous Tracking Schematic

### 7.3.11 Power Good (PGOOD)

The PGOOD pin is an open-drain output requiring an external pullup resistor to output a high signal. Once the output voltage is between 91% and 106% of the setpoint voltage and SS/TR is greater than 0.75 V, the PGOOD pin pulldown is released and the pin floats. A pullup resistor between the values of 10 k $\Omega$  and 100 k $\Omega$  to a voltage source of 6.5 V or less is recommended. The PGOOD pin is pulled low when the output voltage is lower than 89% or greater than 108% of the setpoint voltage.

### 7.3.12 Safe Start-up into Pre-Biased Outputs

The device has been designed to prevent the low-side MOSFET from discharging a pre-biased output. During pre-biased start-up, the low-side MOSFET is not allowed to sink current until the SS/TR pin voltage is higher than the FB pin voltage and the high-side MOSFET begins to switch.

### 7.3.13 Overcurrent Protection

For protection against load faults, the TPSM84824 is protected from overcurrent conditions by cycle-by-cycle current limiting. In an extended overcurrent condition the device enters hiccup mode to reduce power dissipation. In hiccup mode, the module continues in a cycle of successive shutdown and power up until the load fault is removed. During this period, the average current flowing into the fault is significantly reduced, which reduces power dissipation. Once the fault is removed, the module automatically recovers and returns to normal operation.

### 7.3.14 Thermal Shutdown

The internal thermal shutdown circuitry forces the device to stop switching if the junction temperature exceeds 170°C typically. The device reinitiates the power up sequence when the junction temperature drops below 155°C typically.

## 7.4 Device Functional Modes

### 7.4.1 Active Mode

The TPSM84824 is in active mode when VIN is above the UVLO threshold and the EN pin voltage is above the EN high threshold. The EN pin has an internal current source to enable the output when the EN pin is left floating. If the EN pin is pulled low the device is put into a low quiescent current state.

### 7.4.2 Shutdown Mode

The EN pin provides electrical ON and OFF control for the TPSM84824. When the EN pin voltage is below the EN low threshold, the device is in shutdown mode. In shutdown mode the device is put into a low quiescent current state. The TPSM84824 also employs undervoltage lockout protection. If V<sub>IN</sub> is below the UVLO level, the output of the regulator turns off.

## 8 Application and Implementation

### NOTE

Information in the following applications sections is not part of the TI component specification, and TI does not warrant its accuracy or completeness. TI's customers are responsible for determining suitability of components for their purposes. Customers should validate and test their design implementation to confirm system functionality.

### 8.1 Application Information

The TPSM84824 is a fixed-frequency, synchronous step-down DC-DC power module. It is used to convert a higher DC voltage to a lower DC voltage with a maximum output current of 8 A. The following design procedure can be used to select components for the TPSM84824. Alternately, the WEBENCH<sup>®</sup> software may be used to generate complete designs. When generating a design, the WEBENCH software utilizes an iterative design procedure and accesses comprehensive databases of components. See [www.ti.com/webench](http://www.ti.com/webench) for more details.

### 8.2 Typical Application

The TPSM84824 requires only a few external components to convert from a wide input voltage supply range to a wide range of output voltages. Figure 24 shows a typical TPSM84824 schematic with only the minimum required components.

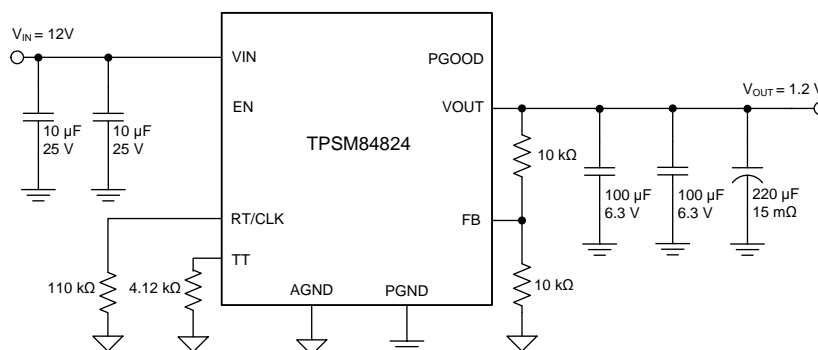

Copyright © 2017, Texas Instruments Incorporated

Figure 24. TPSM84824 Typical Application

#### 8.2.1 Design Requirements

For this design example, use the parameters listed in Table 11 and follow the design procedures in [Detailed Design Procedure](#)

Table 11. Design Example Parameters

DESIGN PARAMETER	VALUE
Input voltage $V_{IN}$	12 V typical
Output voltage $V_{OUT}$	1.2 V
Output current rating	8 A
Key care-about	Small solution size, good transient response
Transient response requirements	3% voltage deviation, 4-A load step, 1-A/µs slew rate

## 8.2.2 Detailed Design Procedure

### 8.2.2.1 Custom Design With WEBENCH® Tools

[Click here](#) to create a custom design using the TPSM84824 device with the WEBENCH® Power Designer.

1. Start by entering the input voltage ( $V_{IN}$ ), output voltage ( $V_{OUT}$ ), and output current ( $I_{OUT}$ ) requirements.
2. Optimize the design for key parameters such as efficiency, footprint, and cost using the optimizer dial.
3. Compare the generated design with other possible solutions from Texas Instruments.

The WEBENCH Power Designer provides a customized schematic along with a list of materials with real-time pricing and component availability.

In most cases, these actions are available:

- Run electrical simulations to see important waveforms and circuit performance
- Run thermal simulations to understand board thermal performance
- Export customized schematic and layout into popular CAD formats
- Print PDF reports for the design, and share the design with colleagues

Get more information about WEBENCH tools at [www.ti.com/WEBENCH](http://www.ti.com/WEBENCH).

### 8.2.2.2 Output Voltage Setpoint

The output voltage of the TPSM84824 device is externally adjustable using a two resistor divider ( $R_{FBT}$  and  $R_{FBB}$ ). The recommended value of  $R_{FBT}$  is 10 k $\Omega$ . Select the value of  $R_{FBB}$  from [Table 1](#) or calculate using [Equation 7](#):

$$R_{FBB} = \frac{6}{(V_{OUT} - 0.6)} \text{ (k}\Omega\text{)} \quad (7)$$

To set the output voltage to 1.2 V, the  $R_{FBB}$  value is 10 k $\Omega$ .

### 8.2.2.3 Setting the Switching Frequency

To set the switching frequency of the TPSM84824 a resistor ( $R_{RT}$ ) between the RT/CLK pin and AGND is required. Select the value of  $R_{RT}$  from [Table 1](#) or calculate using [Equation 8](#):

$$R_{RT} = 58650 \times f_{SW} \text{ (kHz)}^{-1.028} \text{ (k}\Omega\text{)} \quad (8)$$

The recommended switching frequency for a 1.2 V output is 450 kHz. To set the switching frequency to 450 kHz, the  $R_{RT}$  value is 110 k $\Omega$ .

### 8.2.2.4 Input Capacitors

For this design, two 10- $\mu$ F ceramic capacitors rated for 25 V are used for the input decoupling capacitors.

### 8.2.2.5 Output Capacitors

The minimum required output capacitance for a 1.2-V output is 200  $\mu$ F of ceramic capacitance, as listed in [Table 1](#). For this design, two 100- $\mu$ F ceramic capacitors plus a 220- $\mu$ F, 15-m $\Omega$  polymer capacitor where used to meet the transient requirement spec.

### 8.2.2.6 TurboTrans Resistor

A TurboTrans resistor ( $R_{TT}$ ) is required between the TT pin and AGND. The value of  $R_{TT}$  can be calculated using [Equation 9](#). When calculating the  $R_{TT}$  value, the total **effective** output capacitance which takes into account the effects of applied voltage and temperature.

$$R_{TT} = \left[ \left( \frac{K_{TT} \times V_{OUT} \times C_{O(eff)} \text{ (}\mu\text{F)}}{50} \right) - 2 \right] \text{ (k}\Omega\text{)} \quad (9)$$

The calculated value for  $R_{TT}$  for this application is 4.12 k $\Omega$ .

**8.2.2.7 Application Waveforms**

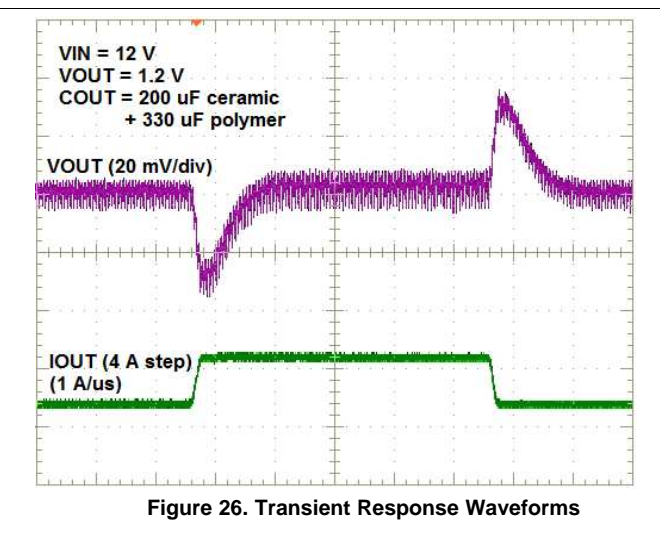
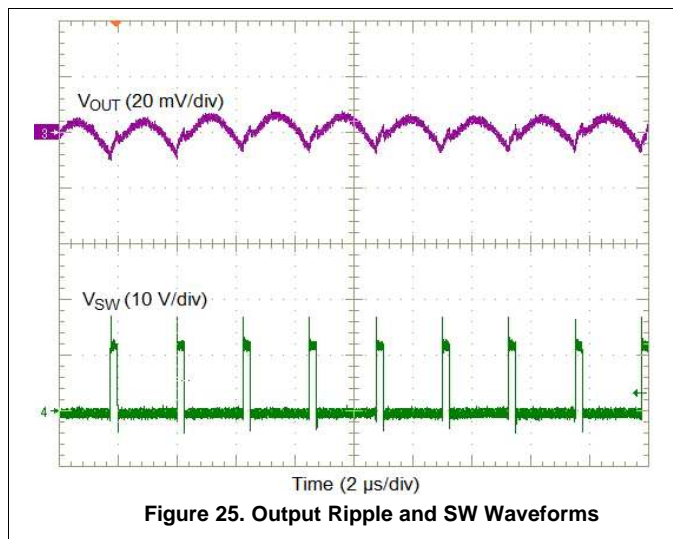

**9 Power Supply Recommendations**

The TPSM84824 is designed to operate from an input voltage supply range between 4.5 V and 17 V. This input supply must be well regulated and able to withstand maximum input current and maintain a stable voltage. The resistance of the input supply rail must be low enough that an input current transient does not cause a high enough drop at the TPSM84824 supply voltage that can cause a false UVLO fault triggering and system reset.

If the input supply is located more than a few inches from the TPSM84824 additional bulk capacitance may be required in addition to the ceramic bypass capacitors. Typically, a 47-μF or 100-μF electrolytic capacitor will suffice.



## 10 Layout

The performance of any switching power supply depends as much upon the layout of the PCB as the component selection. The following guidelines will help users design a PCB with the best power conversion performance, thermal performance, and minimized generation of unwanted EMI.

### 10.1 Layout Guidelines

To achieve optimal electrical and thermal performance, an optimized PCB layout is required. Figure 27 thru Figure 30, shows a typical PCB layout. Some considerations for an optimized layout are:

- Use large copper areas for power planes (VIN, VOUT, and PGND) to minimize conduction loss and thermal stress.
- Place ceramic input and output capacitors close to the device pins to minimize high frequency noise.
- Locate additional output capacitors between the ceramic capacitor and the load.
- Keep AGND and PGND separate from one another. The connection is made internal to the device.
- Place  $R_{FBB}$ ,  $R_{RT}$ , and  $C_{SS}$  as close as possible to their respective pins.
- Use multiple vias to connect the power planes (VIN, VOUT, and PGND) to internal layers.

### 10.2 Layout Examples

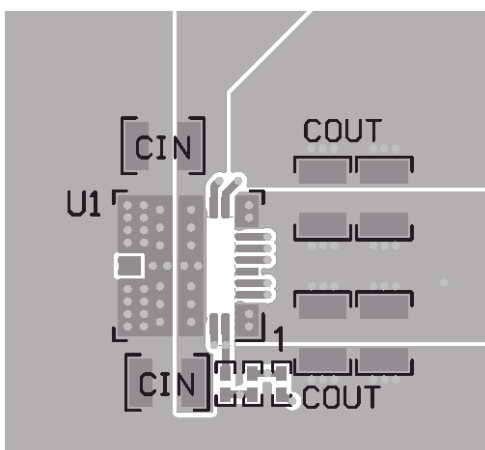

Figure 27. Typical Top-Layer Layout

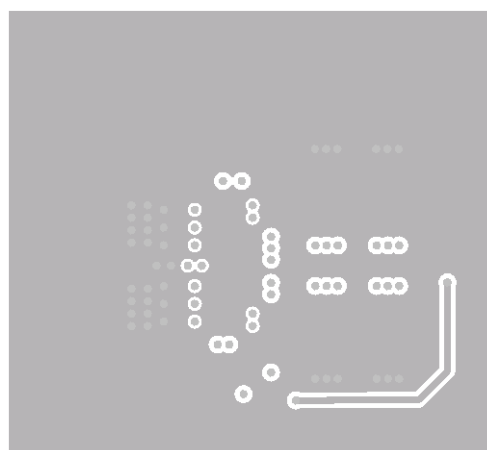

Figure 28. Typical Layer-2 Layout

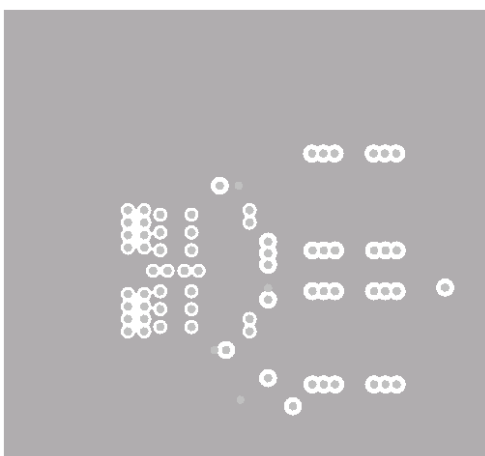

Figure 29. Typical Layer-3 Layout

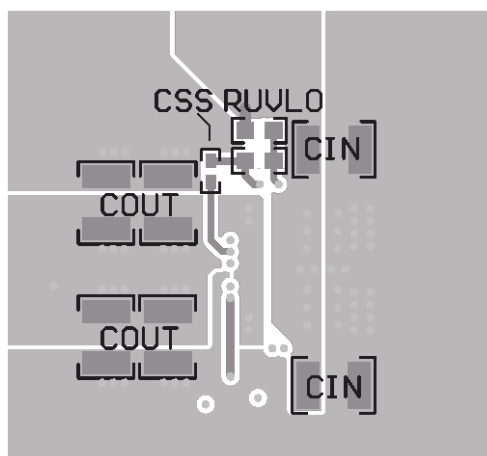

Figure 30. Typical Bottom-Layer Layout (Bottom View)



### 10.3 EMI

The TPSM84824 is compliant with EN55011 Class B radiated emissions. [Figure 31](#), [Figure 32](#), and [Figure 33](#) show typical examples of radiated emissions plots for the TPSM84824. The graphs include the plots of the antenna in the horizontal and vertical positions.

#### 10.3.1 EMI Plots

EMI plots were measured using the standard TPSM84824EVM with no input filter.

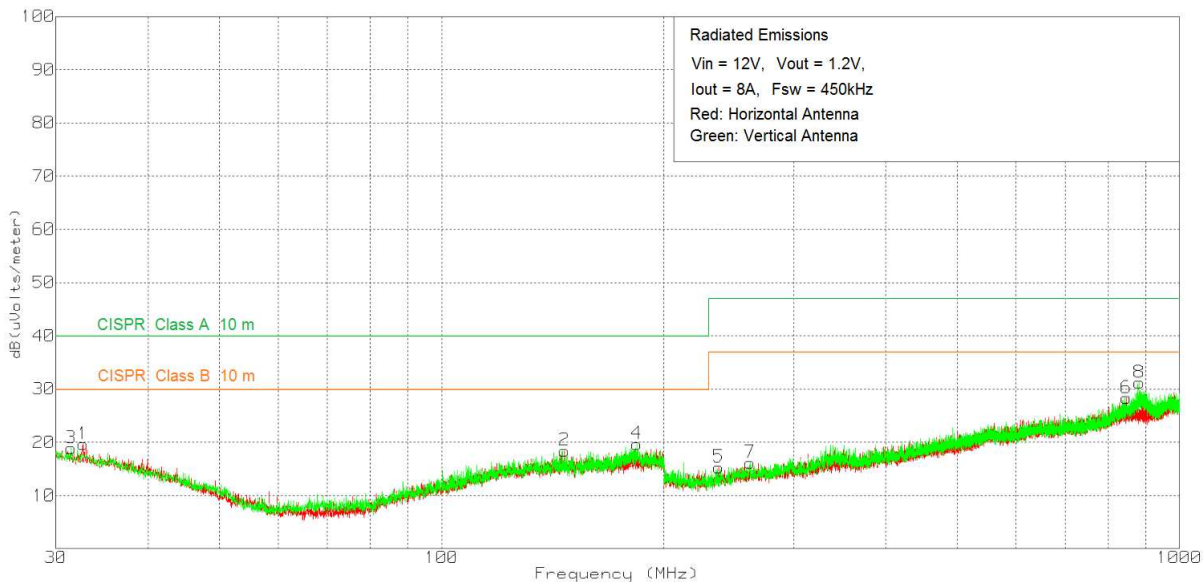

**Figure 31. Radiated Emissions 12-V Input, 1.2-V Output, 8-A Load (EN55011 Class B)**

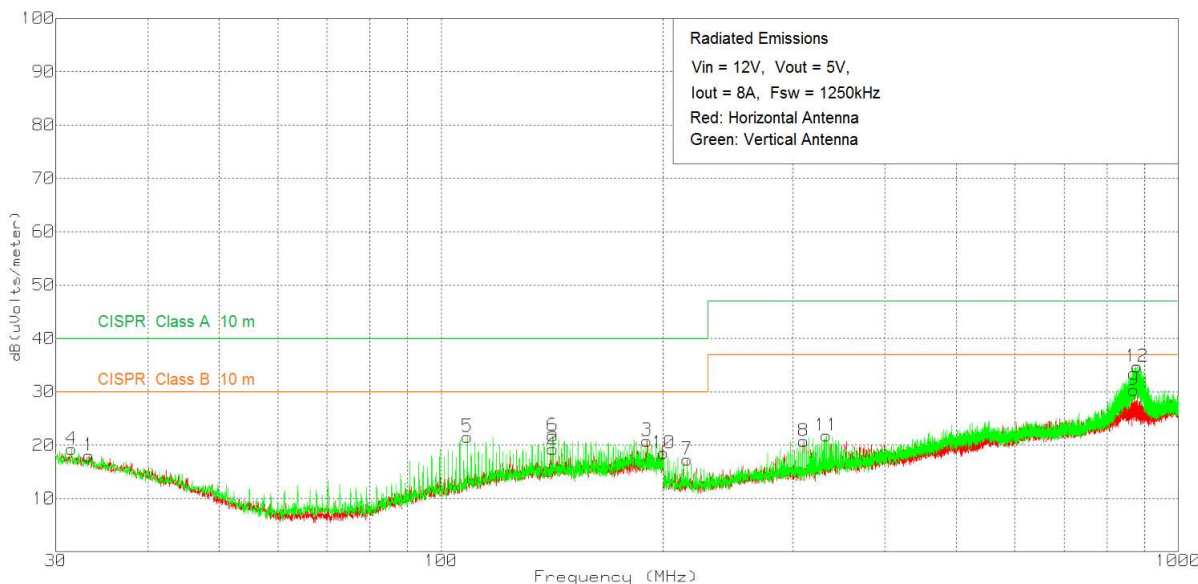

**Figure 32. Radiated Emissions 12-V Input, 5-V Output, 8-A Load (EN55011 Class B)**

EMI (continued)

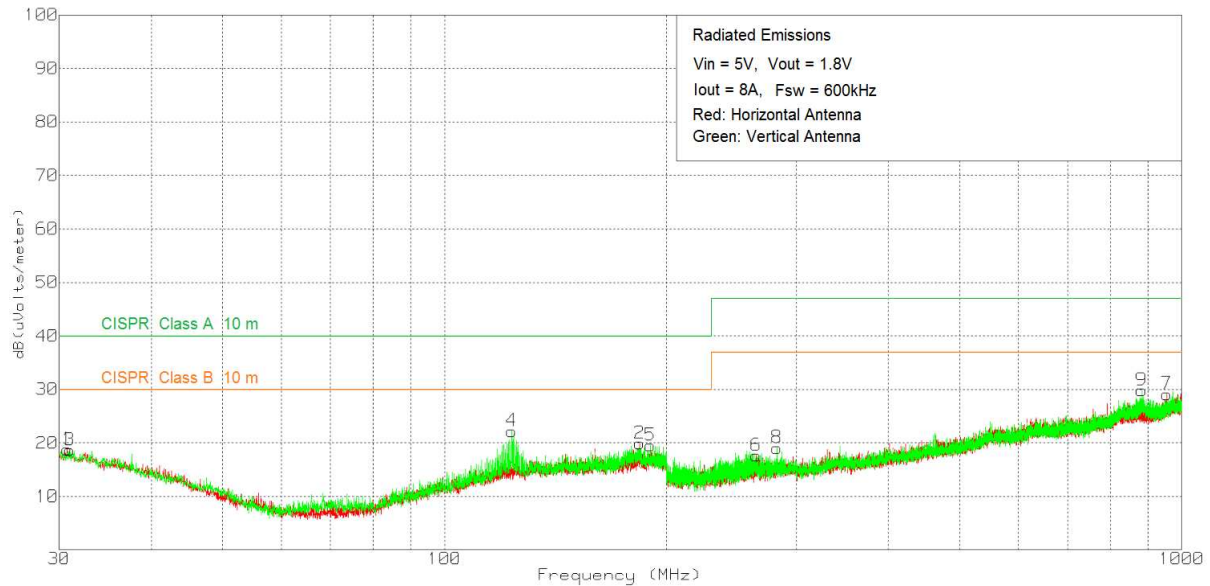

Figure 33. Radiated Emissions 5-V Input, 1.8-V Output, 8-A Load (EN55011 Class B)

10.4 Package Specifications

TPSM84824		VALUE	UNIT
Weight		0.90	grams
Flammability	Meets UL 94 V-O		
MTBF Calculated Reliability	Per Bellcore TR-332, 50% stress, T <sub>A</sub> = 40°C, ground benign	73.5	MHrs

## 11 Device and Documentation Support

### 11.1 Device Support

#### 11.1.1 Third-Party Products Disclaimer

TI'S PUBLICATION OF INFORMATION REGARDING THIRD-PARTY PRODUCTS OR SERVICES DOES NOT CONSTITUTE AN ENDORSEMENT REGARDING THE SUITABILITY OF SUCH PRODUCTS OR SERVICES OR A WARRANTY, REPRESENTATION OR ENDORSEMENT OF SUCH PRODUCTS OR SERVICES, EITHER ALONE OR IN COMBINATION WITH ANY TI PRODUCT OR SERVICE.

#### 11.1.2 Development Support

##### 11.1.2.1 Custom Design With WEBENCH® Tools

[Click here](#) to create a custom design using the TPSM84824 device with the WEBENCH® Power Designer.

1. Start by entering the input voltage ( $V_{IN}$ ), output voltage ( $V_{OUT}$ ), and output current ( $I_{OUT}$ ) requirements.
2. Optimize the design for key parameters such as efficiency, footprint, and cost using the optimizer dial.
3. Compare the generated design with other possible solutions from Texas Instruments.

The WEBENCH Power Designer provides a customized schematic along with a list of materials with real-time pricing and component availability.

In most cases, these actions are available:

- Run electrical simulations to see important waveforms and circuit performance
- Run thermal simulations to understand board thermal performance
- Export customized schematic and layout into popular CAD formats
- Print PDF reports for the design, and share the design with colleagues

Get more information about WEBENCH tools at [www.ti.com/WEBENCH](http://www.ti.com/WEBENCH).

### 11.2 Receiving Notification of Documentation Updates

To receive notification of documentation updates, navigate to the device product folder on ti.com. In the upper right corner, click on *Alert me* to register and receive a weekly digest of any product information that has changed. For change details, review the revision history included in any revised document.

### 11.3 Community Resources

The following links connect to TI community resources. Linked contents are provided "AS IS" by the respective contributors. They do not constitute TI specifications and do not necessarily reflect TI's views; see TI's [Terms of Use](#).

**TI E2E™ Online Community** *TI's Engineer-to-Engineer (E2E) Community*. Created to foster collaboration among engineers. At [e2e.ti.com](http://e2e.ti.com), you can ask questions, share knowledge, explore ideas and help solve problems with fellow engineers.

**Design Support** *TI's Design Support* Quickly find helpful E2E forums along with design support tools and contact information for technical support.

### 11.4 Trademarks

TurboTrans, E2E are trademarks of Texas Instruments.  
WEBENCH is a registered trademark of Texas Instruments.  
All other trademarks are the property of their respective owners.

### 11.5 Electrostatic Discharge Caution



These devices have limited built-in ESD protection. The leads should be shorted together or the device placed in conductive foam during storage or handling to prevent electrostatic damage to the MOS gates.

## 11.6 Glossary

[SLYZ022](#) — TI Glossary.

This glossary lists and explains terms, acronyms, and definitions.

## 12 Mechanical, Packaging, and Orderable Information

The following pages include mechanical packaging and orderable information. This information is the most current data available for the designated devices. This data is subject to change without notice and revision of this document. For browser-based versions of this data sheet, refer to the left-hand navigation.

### 12.1 Tape and Reel Information

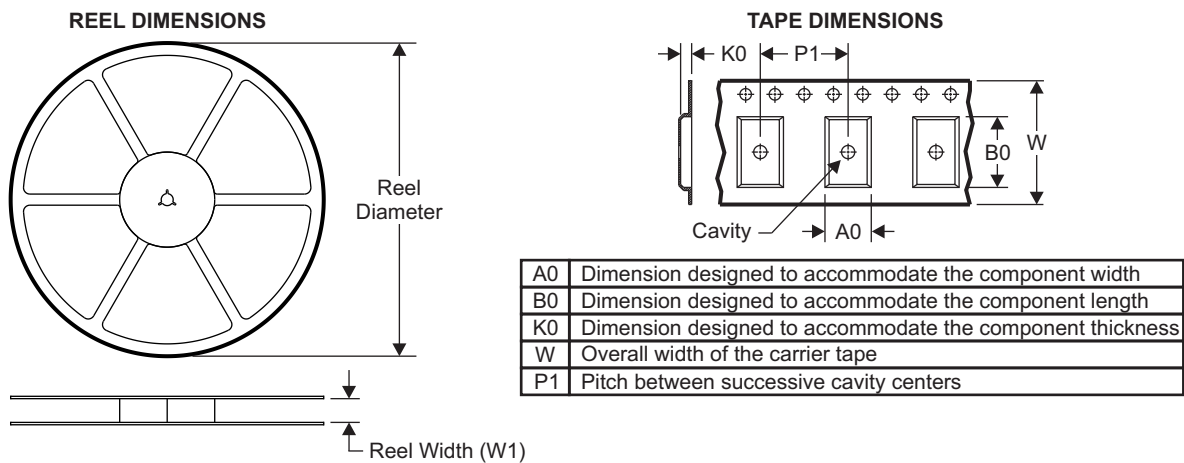

#### QUADRANT ASSIGNMENTS FOR PIN 1 ORIENTATION IN TAPE

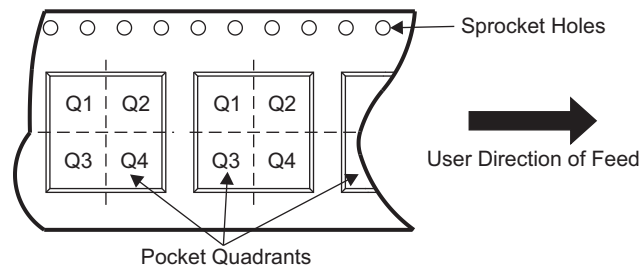

Device	Package Type	Package Drawing	Pins	SPQ	Reel Diameter (mm)	Reel Width W1 (mm)	A0 (mm)	B0 (mm)	K0 (mm)	P1 (mm)	W (mm)	Pin1 Quadrant
TPSM84824MOLR	QFM	MOL	24	500	330.0	16.0	7.8	7.8	5.81	12.0	16.0	Q2

**TAPE AND REEL BOX DIMENSIONS**

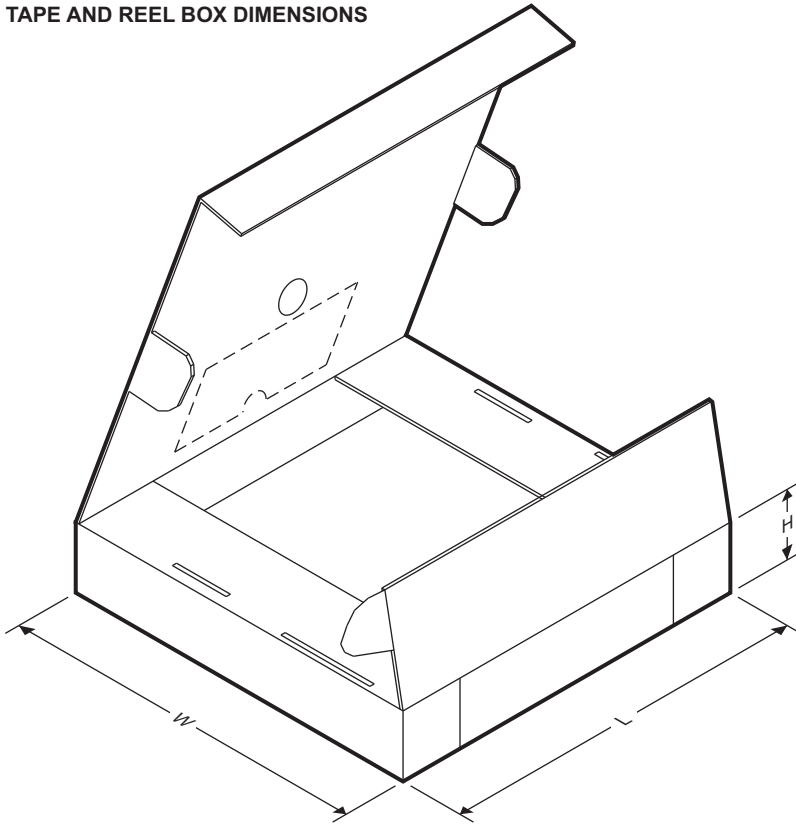

Device	Package Type	Package Drawing	Pins	SPQ	Length (mm)	Width (mm)	Height (mm)
TPSM84824MOLR	QFM	MOL	24	500	383.0	353.0	58.0

**PACKAGING INFORMATION**

Orderable Device	Status (1)	Package Type	Package Drawing	Pins	Package Qty	Eco Plan (2)	Lead/Ball Finish (6)	MSL Peak Temp (3)	Op Temp (°C)	Device Marking (4/5)	Samples
TPSM84824MOLR	ACTIVE	QFM	MOL	24	500	RoHS Exempt & Green	NIAU	Level-3-260C-168 HR	-40 to 105	TPSM84824	

(1) The marketing status values are defined as follows:

**ACTIVE:** Product device recommended for new designs.

**LIFEBUY:** TI has announced that the device will be discontinued, and a lifetime-buy period is in effect.

**NRND:** Not recommended for new designs. Device is in production to support existing customers, but TI does not recommend using this part in a new design.

**PREVIEW:** Device has been announced but is not in production. Samples may or may not be available.

**OBSOLETE:** TI has discontinued the production of the device.

(2) **RoHS:** TI defines "RoHS" to mean semiconductor products that are compliant with the current EU RoHS requirements for all 10 RoHS substances, including the requirement that RoHS substance do not exceed 0.1% by weight in homogeneous materials. Where designed to be soldered at high temperatures, "RoHS" products are suitable for use in specified lead-free processes. TI may reference these types of products as "Pb-Free".

**RoHS Exempt:** TI defines "RoHS Exempt" to mean products that contain lead but are compliant with EU RoHS pursuant to a specific EU RoHS exemption.

**Green:** TI defines "Green" to mean the content of Chlorine (Cl) and Bromine (Br) based flame retardants meet JS709B low halogen requirements of <=1000ppm threshold. Antimony trioxide based flame retardants must also meet the <=1000ppm threshold requirement.

(3) MSL, Peak Temp. - The Moisture Sensitivity Level rating according to the JEDEC industry standard classifications, and peak solder temperature.

(4) There may be additional marking, which relates to the logo, the lot trace code information, or the environmental category on the device.

(5) Multiple Device Markings will be inside parentheses. Only one Device Marking contained in parentheses and separated by a "~" will appear on a device. If a line is indented then it is a continuation of the previous line and the two combined represent the entire Device Marking for that device.

(6) Lead/Ball Finish - Orderable Devices may have multiple material finish options. Finish options are separated by a vertical ruled line. Lead/Ball Finish values may wrap to two lines if the finish value exceeds the maximum column width.

**Important Information and Disclaimer:**The information provided on this page represents TI's knowledge and belief as of the date that it is provided. TI bases its knowledge and belief on information provided by third parties, and makes no representation or warranty as to the accuracy of such information. Efforts are underway to better integrate information from third parties. TI has taken and continues to take reasonable steps to provide representative and accurate information but may not have conducted destructive testing or chemical analysis on incoming materials and chemicals. TI and TI suppliers consider certain information to be proprietary, and thus CAS numbers and other limited information may not be available for release.

In no event shall TI's liability arising out of such information exceed the total purchase price of the TI part(s) at issue in this document sold by TI to Customer on an annual basis.



# EXAMPLE BOARD LAYOUT

MOL0024A

QFM - 5.4 mm max height

QUAD FLAT MODULE

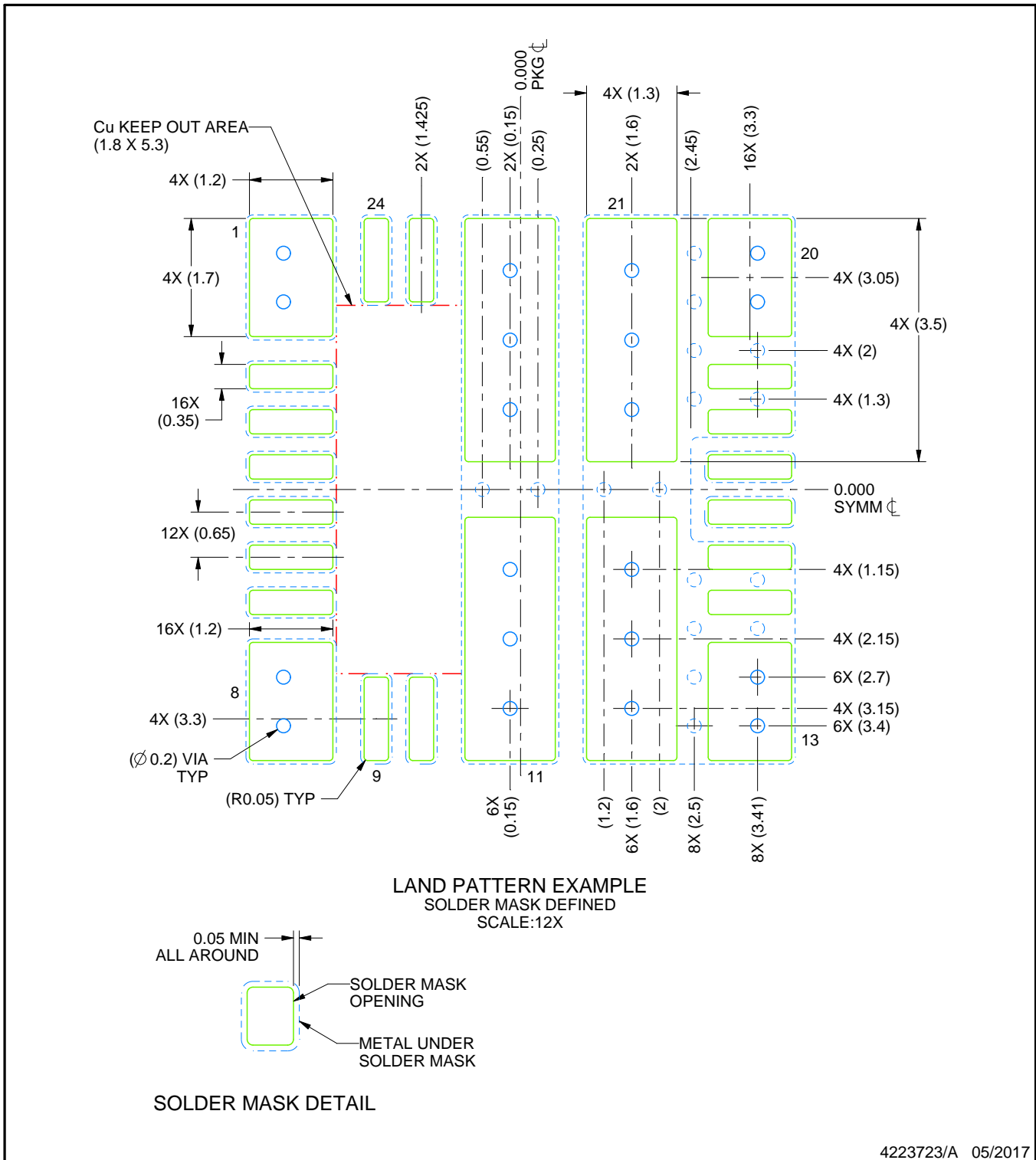

NOTES: (continued)

4. This package is designed to be soldered to the thermal pads on the board. For more information, see Texas Instruments literature number SLUA271 ([www.ti.com/lit/sluea271](http://www.ti.com/lit/sluea271)).
5. Vias are optional depending on application, refer to device data sheet. If any vias are implemented, refer to their locations shown on this view. It is recommended that vias under paste be filled, plugged or tented.





## IMPORTANT NOTICE AND DISCLAIMER

TI PROVIDES TECHNICAL AND RELIABILITY DATA (INCLUDING DATASHEETS), DESIGN RESOURCES (INCLUDING REFERENCE DESIGNS), APPLICATION OR OTHER DESIGN ADVICE, WEB TOOLS, SAFETY INFORMATION, AND OTHER RESOURCES "AS IS" AND WITH ALL FAULTS, AND DISCLAIMS ALL WARRANTIES, EXPRESS AND IMPLIED, INCLUDING WITHOUT LIMITATION ANY IMPLIED WARRANTIES OF MERCHANTABILITY, FITNESS FOR A PARTICULAR PURPOSE OR NON-INFRINGEMENT OF THIRD PARTY INTELLECTUAL PROPERTY RIGHTS.

These resources are intended for skilled developers designing with TI products. You are solely responsible for (1) selecting the appropriate TI products for your application, (2) designing, validating and testing your application, and (3) ensuring your application meets applicable standards, and any other safety, security, or other requirements. These resources are subject to change without notice. TI grants you permission to use these resources only for development of an application that uses the TI products described in the resource. Other reproduction and display of these resources is prohibited. No license is granted to any other TI intellectual property right or to any third party intellectual property right. TI disclaims responsibility for, and you will fully indemnify TI and its representatives against, any claims, damages, costs, losses, and liabilities arising out of your use of these resources.

TI's products are provided subject to TI's Terms of Sale ([www.ti.com/legal/termsofsale.html](http://www.ti.com/legal/termsofsale.html)) or other applicable terms available either on [ti.com](http://ti.com) or provided in conjunction with such TI products. TI's provision of these resources does not expand or otherwise alter TI's applicable warranties or warranty disclaimers for TI products.

Mailing Address: Texas Instruments, Post Office Box 655303, Dallas, Texas 75265  
Copyright © 2019, Texas Instruments Incorporated