

Data sheet | Item number: 255-612

PCB terminal block; push-button; 2.5 mm²; Pin spacing 10/10.16 mm; 12-pole; CAGE CLAMP®; commoning option; 2,50 mm²; gray

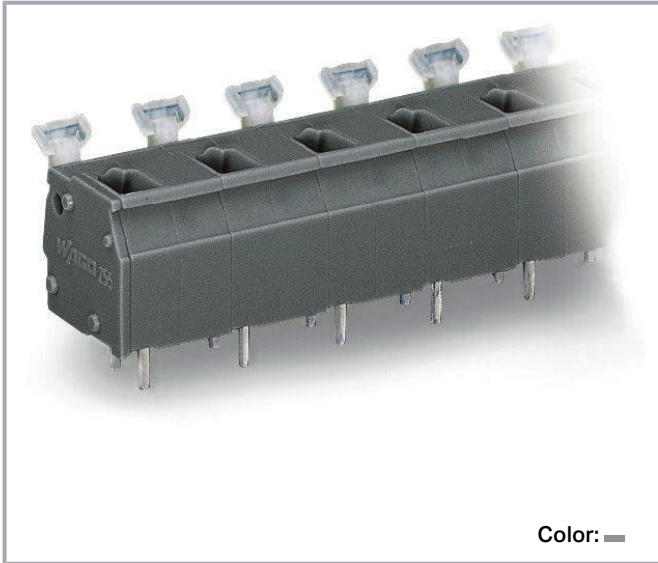

www.wago.com/255-612



Color: ■

Current-Carrying Capacity Curve
Pin spacing: 5 mm / Conductor cross-section: 2.5 mm² "f-st"
Based on: EN 60512-5-2 / Reduction factor: 1

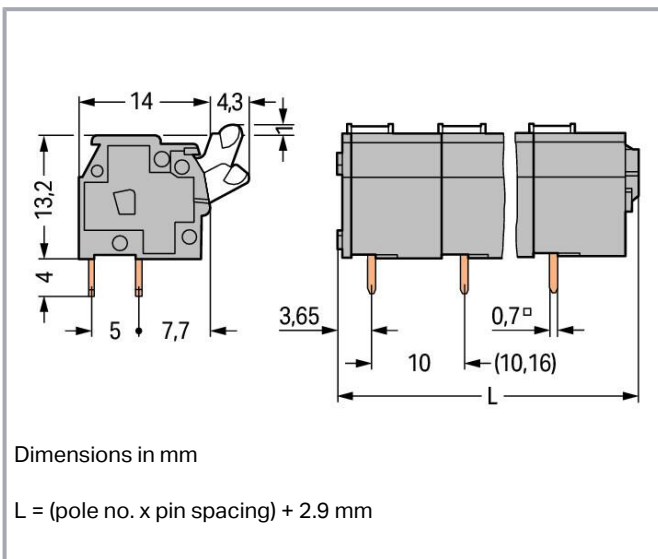
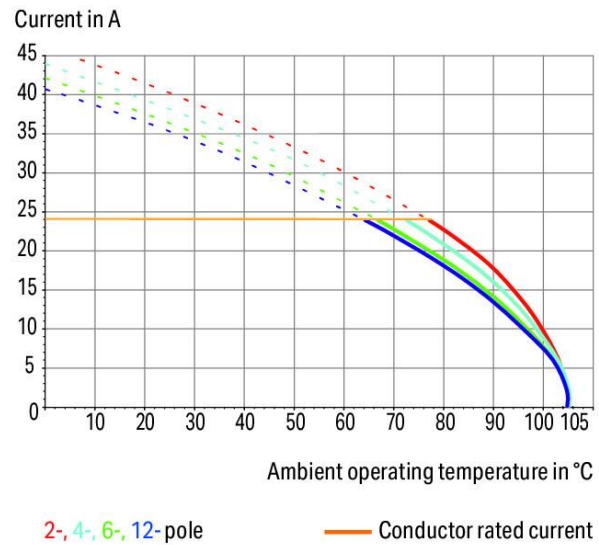

Subject to changes. Please also observe the further product documentation!

WAGO GmbH & Co. KG
Hansastr. 27
32423 Minden
Phone: +49571 887-0 | Fax: +49571 887-169
Email: info.de@wago.com | Web: www.wago.com

Do you have any questions about our products?
We are always happy to take your call at +49 (571) 887-44222.



Item description

- PCB terminal blocks with push-buttons and CAGE CLAMP® connection
- Versions with Ex approval
- Set to metric or inch pin spacing by compressing PCB terminal strips or pulling them apart
- Ideal for in-the-field wiring thanks to simplified push-button actuation
- Convenient, tool-free operation

Data

Notes

Variants:

Other pole numbers

Versions for Ex e II and Ex i

Other colors

Mixed-color PCB connector strips

Direct marking

Other versions (or variants) can be requested from WAGO Sales or configured at <https://configurator.wago.com/>.

Electrical data

Ratings per IEC/EN

Ratings per	IEC/EN 60664-1
Nominal voltage (III/3)	630 V
Rated impulse voltage (III/3)	8 kV
Rated voltage (III/2)	1000 V
Rated impulse voltage (III/2)	8 kV
Nominal voltage (II/2)	1000 V
Rated surge voltage (II/2)	8 kV
Rated current	24 A
Legend (ratings)	(III / 2) ≙ Overvoltage category III / Pollution degree 2

Ratings per UL 1059

Approvals per	UL 1059
Rated voltage UL (Use Group B)	300 V
Rated current UL (Use Group B)	15 A
Rated voltage UL (Use Group D)	300 V
Rated current UL (Use Group D)	10 A

Subject to changes. Please also observe the further product documentation!

WAGO GmbH & Co. KG

Hansastr. 27

32423 Minden

Phone: +49571 887-0 | Fax: +49571 887-169

Email: info.de@wago.com | Web: www.wago.com

Do you have any questions about our products?

We are always happy to take your call at +49 (571) 887-44222.



Ratings per CSA

Approvals per	CSA
Rated voltage CSA (Use Group B)	300 V
Rated current CSA (Use Group B)	15 A
Rated voltage CSA (Use Group D)	300 V
Rated current CSA (Use Group D)	10 A

Connection data

Connection points	12
Total number of potentials	12
Number of connection types	1
Number of levels	1

Connection 1

Connection technology	CAGE CLAMP®
Actuation type	Push-button
Solid conductor	0.08 ... 2.5 mm ² / 25 ... 12 AWG
Fine-stranded conductor	0.08 ... 2.5 mm ² / 28 ... 12 AWG
Fine-stranded conductor; with insulated ferrule	0.25 ... 1.5 mm ²
Fine-stranded conductor; with uninsulated ferrule	0.25 ... 1.5 mm ²
Note (conductor cross-section)	12 AWG: THHN, THWN
Strip length	5 ... 6 mm / 0.2 ... 0.24 inches
Conductor connection direction to PCB	90 °
Pole number	12

Physical data

Pin spacing	10/10.16 mm / 0.394/0.4 inches
Width	122.9 mm / 4.839 inches
Height	18.2 mm / 0.717 inches
Height from the surface	14.2 mm / 0.559 inches
Depth	18.3 mm / 0.72 inches
Solder pin length	4 mm
Solder pin dimensions	0.7 x 0.7 mm
Drilled hole diameter with tolerance	1.1 ^(+0.1) mm

Subject to changes. Please also observe the further product documentation!

WAGO GmbH & Co. KG
 Hansastr. 27
 32423 Minden
 Phone: +49571 887-0 | Fax: +49571 887-169
 Email: info.de@wago.com | Web: www.wago.com

Do you have any questions about our products?
 We are always happy to take your call at +49 (571) 887-44222.



PCB contact

PCB contact	THT
Solder pin arrangement	over the entire terminal strip (in-line)
Number of solder pins per potential	2

Material Data

Note (material data)

Information on material specifications can be found here

Color	gray
Material group	I
Insulation material	Polyamide (PA66)
Flammability class per UL94	V0
Clamping spring material	Chrome-nickel spring steel (CrNi)
Contact material	Electrolytic copper (E _{Cu})
Contact plating	Tin
Fire load	0.462 MJ
Weight	20.3 g

Environmental requirements

Limit temperature range	-60 ... +105 °C
-------------------------	-----------------

Commercial data

Product Group	4 (Printed Circuit Connectors)
eCl@ss 10.0	27-44-04-01
eCl@ss 9.0	27-44-04-01
ETIM 8.0	EC002643
ETIM 7.0	EC002643
PU (SPU)	40 (10) pcs
Packaging type	box
Country of origin	CH
GTIN	4044918662628
Customs tariff number	85369010000

Subject to changes. Please also observe the further product documentation!

WAGO GmbH & Co. KG
 Hansastr. 27
 32423 Minden
 Phone: +49571 887-0 | Fax: +49571 887-169
 Email: info.de@wago.com | Web: www.wago.com

Do you have any questions about our products?
 We are always happy to take your call at +49 (571) 887-44222.





Environmental Product Compliance

RoHS Compliance Status



Compliant, No Exemption

Approvals / Certificates

General approvals



Logo	Approval	Additional Approval Text	Certificate name
	CCA DEKRA Certification B.V.	EN 60947	NTR NL-7146
	CCA DEKRA Certification B.V.	EN 60947	2160584.40
	CCA DEKRA Certification B.V.	EN 60947-7-4	71-113038
	CCA DEKRA Certification B.V.	IEC 60947-7-4	NTR NL-7822
	UR Underwriters Laboratories Inc.	UL 1059	E45172

Declarations of conformity and manufacturer's declarations

Logo	Approval	Additional Approval Text	Certificate name
	EU-Declaration of Conformity WAGO GmbH & Co. KG	-	-
	UK-Declaration of Conformity WAGO GmbH & Co. KG	-	-

Approvals for marine applications

Subject to changes. Please also observe the further product documentation!

Logo	Approval	Additional Approval Text	Certificate name
	ABS American Bureau of Shipping	-	19- HG1869876- PDA
	BV Bureau Veritas S.A.	IEC 60998	11915/DO BV
	DNV GL Det Norske Veritas, Germanischer Lloyd	-	TAE000016Z

Optional accessories

Tool

Operating tool



Item no.: 210-658

Operating tool; Blade: 3.5 x 0.5 mm; with a partially insulated shaft; angled; short; multicoloured

www.wago.com/210-658



Item no.: 210-720

Operating tool; Blade: 3.5 x 0.5 mm; with a partially insulated shaft; multicoloured

www.wago.com/210-720

Marking accessories

Marking strip



Item no.: 210-332/1016-202

Marking strips; as a DIN A4 sheet; MARKED; 1-16 (80x); Height of marker strip: 3 mm; Strip length 182 mm; Horizontal marking; Self-adhesive; white

www.wago.com/210-332/1016-202



Item no.: 210-332/1016-204

Marking strips; as a DIN A4 sheet; MARKED; 17-31 (80x); Height of marker strip: 3 mm; Strip length 182 mm; Horizontal marking; Self-adhesive; white

www.wago.com/210-332/1016-204



Item no.: 210-332/1000-202

Marking strips; as a DIN A4 sheet; MARKED; 1-16 (80x); Height of marker strip: 3 mm; Strip length 182 mm; Horizontal marking; Self-adhesive; white

www.wago.com/210-332/1000-202



Item no.: 210-332/1000-204

Marking strips; as a DIN A4 sheet; MARKED; 17-31 (80x); Height of marker strip: 3 mm; Strip length 182 mm; Horizontal marking; Self-adhesive; white

www.wago.com/210-332/1000-204

Subject to changes. Please also observe the further product documentation!

WAGO GmbH & Co. KG

Hansastr. 27



32423 Minden

Phone: +49571 887-0 | Fax: +49571 887-169



Email: info.de@wago.com | Web: www.wago.com











Do you have any questions about our products?

We are always happy to take your call at +49 (571) 887-44222.

	Item no.: 210-332/1016-206 Marking strips; as a DIN A4 sheet; MARKED; 33-48 (80x); Height of marker strip: 3 mm; Strip length 182 mm; Horizontal marking; Self-adhesive; white	www.wago.com/210-332/1016-206
	Item no.: 210-332/1000-206 Marking strips; as a DIN A4 sheet; MARKED; 33-48 (80x); Height of marker strip: 3 mm; Strip length 182 mm; Horizontal marking; Self-adhesive; white	www.wago.com/210-332/1000-206
	Item no.: 210-833 Marking strips; 25 m on roll; 6 mm wide; plain; Self-adhesive; white	www.wago.com/210-833

Testing and measuring

Testing accessories		
	Item no.: 249-114 Test plug adapter; suitable for 255, 256, 257 Series PCB terminal blocks; 1-pole; Pin spacing 10 mm / 0.394 in; gray	www.wago.com/249-114
	Item no.: 249-115 Test plug adapter; suitable for 255, 256, 257 Series PCB terminal blocks; 1-pole; Pin spacing 10.16 mm / 0.4 in; orange	www.wago.com/249-115

Ferrule		
Ferrule		
	Item no.: 216-101 Ferrule; Sleeve for 0.5 mm ² / AWG 22; uninsulated; electro-tin plated; silver-colored	www.wago.com/216-101
	Item no.: 216-104 Ferrule; Sleeve for 1.5 mm ² / AWG 16; uninsulated; electro-tin plated; silver-colored	www.wago.com/216-104
	Item no.: 216-102 Ferrule; Sleeve for 0.75 mm ² / AWG 20; uninsulated; electro-tin plated; silver-colored	www.wago.com/216-102
	Item no.: 216-103 Ferrule; Sleeve for 1 mm ² / AWG 18; uninsulated; electro-tin plated	www.wago.com/216-103
	Item no.: 216-123 Ferrule; Sleeve for 1 mm ² / AWG 18; uninsulated; electro-tin plated; silver-colored	www.wago.com/216-123
	Item no.: 216-122 Ferrule; Sleeve for 0.75 mm ² / AWG 20; uninsulated; electro-tin plated; silver-colored	www.wago.com/216-122
	Item no.: 216-124 Ferrule; Sleeve for 1.5 mm ² / AWG 16; uninsulated; electro-tin plated	www.wago.com/216-124
	Item no.: 216-142 Ferrule; Sleeve for 0.75 mm ² / 18 AWG; uninsulated; electro-tin plated; electrolytic copper; gastight crimped; acc. to DIN 46228, Part 1/08.92	www.wago.com/216-142
	Item no.: 216-132 Ferrule; Sleeve for 0.34 mm ² / AWG 24; uninsulated; electro-tin plated	www.wago.com/216-132
	Item no.: 216-121 Ferrule; Sleeve for 0.5 mm ² / AWG 22; uninsulated; electro-tin plated; silver-colored	www.wago.com/216-121
	Item no.: 216-143	

Subject to changes. Please also observe the further product documentation!











	Ferrule; Sleeve for 1 mm ² / AWG 18; uninsulated; electro-tin plated; electrolytic copper; gastight crimped; acc. to DIN 46228, Part 1/08.92	www.wago.com/216-143
	Item no.: 216-131 Ferrule; Sleeve for 0.25 mm ² / AWG 24; uninsulated; electro-tin plated; silver-colored	www.wago.com/216-131
	Item no.: 216-141 Ferrule; Sleeve for 0.5 mm ² / 20 AWG; uninsulated; electro-tin plated; electrolytic copper; gastight crimped; acc. to DIN 46228, Part 1/08.92	www.wago.com/216-141
	Item no.: 216-152 Ferrule; Sleeve for 0.34 mm ² / AWG 24; uninsulated; electro-tin plated	www.wago.com/216-152
	Item no.: 216-203 Ferrule; Sleeve for 1 mm ² / AWG 18; insulated; electro-tin plated; red	www.wago.com/216-203
	Item no.: 216-202 Ferrule; Sleeve for 0.75 mm ² / 18 AWG; insulated; electro-tin plated; gray	www.wago.com/216-202
	Item no.: 216-151 Ferrule; Sleeve for 0.25 mm ² / AWG 24; uninsulated; electro-tin plated	www.wago.com/216-151
	Item no.: 216-204 Ferrule; Sleeve for 1.5 mm ² / AWG 16; insulated; electro-tin plated; black	www.wago.com/216-204
	Item no.: 216-144 Ferrule; Sleeve for 1.5 mm ² / AWG 16; uninsulated; electro-tin plated; electrolytic copper; gastight crimped; acc. to DIN 46228, Part 1/08.92; silver-colored	www.wago.com/216-144
	Item no.: 216-201 Ferrule; Sleeve for 0.5 mm ² / 20 AWG; insulated; electro-tin plated; white	www.wago.com/216-201
	Item no.: 216-223 Ferrule; Sleeve for 1 mm ² / AWG 18; insulated; electro-tin plated; red	www.wago.com/216-223
	Item no.: 216-241 Ferrule; Sleeve for 0.5 mm ² / 20 AWG; insulated; electro-tin plated; electrolytic copper; gastight crimped; acc. to DIN 46228, Part 4/09.90; white	www.wago.com/216-241
	Item no.: 216-242 Ferrule; Sleeve for 0.75 mm ² / 18 AWG; insulated; electro-tin plated; electrolytic copper; gastight crimped; acc. to DIN 46228, Part 4/09.90; gray	www.wago.com/216-242
	Item no.: 216-222 Ferrule; Sleeve for 0.75 mm ² / 18 AWG; insulated; electro-tin plated; gray	www.wago.com/216-222
	Item no.: 216-221 Ferrule; Sleeve for 0.5 mm ² / 20 AWG; insulated; electro-tin plated; white	www.wago.com/216-221
	Item no.: 216-224 Ferrule; Sleeve for 1.5 mm ² / AWG 16; insulated; electro-tin plated; black	www.wago.com/216-224
	Item no.: 216-243 Ferrule; Sleeve for 1 mm ² / AWG 18; insulated; electro-tin plated; electrolytic copper; gastight crimped; acc. to DIN 46228, Part 4/09.90; red	www.wago.com/216-243
	Item no.: 216-244 Ferrule; Sleeve for 1.5 mm ² / AWG 16; insulated; electro-tin plated; electrolytic copper; gastight	www.wago.com/216-244

Subject to changes. Please also observe the further product documentation!



crimped; acc. to DIN 46228, Part 4/09.90; black

	Item no.: 216-263 Ferrule; Sleeve for 1 mm ² / AWG 18; insulated; electro-tin plated; electrolytic copper; gastight crimped; acc. to DIN 46228, Part 4/09.90; red	www.wago.com/216-263
	Item no.: 216-264 Ferrule; Sleeve for 1.5 mm ² / AWG 16; insulated; electro-tin plated; electrolytic copper; gastight crimped; acc. to DIN 46228, Part 4/09.90; black	www.wago.com/216-264
	Item no.: 216-284 Ferrule; Sleeve for 1.5 mm ² / AWG 16; insulated; electro-tin plated; electrolytic copper; gastight crimped; acc. to DIN 46228, Part 4/09.90; black	www.wago.com/216-284
	Item no.: 216-262 Ferrule; Sleeve for 0.75 mm ² / 18 AWG; insulated; electro-tin plated; electrolytic copper; gastight crimped; acc. to DIN 46228, Part 4/09.90; gray	www.wago.com/216-262
	Item no.: 216-301 Ferrule; Sleeve for 0.25 mm ² / AWG 24; insulated; electro-tin plated; yellow	www.wago.com/216-301
	Item no.: 216-321 Ferrule; Sleeve for 0.25 mm ² / AWG 24; insulated; electro-tin plated; yellow	www.wago.com/216-321
	Item no.: 216-322 Ferrule; Sleeve for 0.34 mm ² / 22 AWG; insulated; electro-tin plated; light turquoise	www.wago.com/216-322
	Item no.: 216-302 Ferrule; Sleeve for 0.34 mm ² / 22 AWG; insulated; electro-tin plated; light turquoise	www.wago.com/216-302

Downloads

Documentation

Additional Information

Technical Section	2019 Apr 3	pdf 2.0 MB	Download
Technical explanations			
Gebrückte Klemmenleisten für Leiterplatten		pdf 187.6 kB	Download

CAD/CAE-Data

CAE data

EPLAN Data Portal 255-612	URL	Download
ZUKEN Portal 255-612	URL	Download

PCB Design

Subject to changes. Please also observe the further product documentation!

WAGO GmbH & Co. KG
Hansastr. 27
32423 Minden
Phone: +49571 887-0 | Fax: +49571 887-169
Email: info.de@wago.com | Web: www.wago.com

Do you have any questions about our products?
We are always happy to take your call at +49 (571) 887-44222.



[URL](#)

[Download](#)

Symbol and Footprint 255-612

CAX data for your PCB design, consisting of "schematic symbols and PCB footprints", allow easy integration of the WAGO component into your development environment.

Supported formats:

- Accel EDA 14 & 15
- Altium 6 to current version
- Cadence Allegro
- DesignSpark
- Eagle Libraries
- KiCad
- Mentor Graphics BoardStation
- Mentor Graphics Design Architect
- Mentor Graphics Design Expedition 99 and 2000
- OrCAD 9.X PCB and Capture
- PADS PowerPCB 3, 3.5, 4.X, and 5.X
- PADS PowerPCB and PowerLogic 3.0
- PCAD 2000, 2001, 2002, 2004, and 2006
- Pulsonix 8.5 or newer
- STL
- 3D STEP
- TARGET 3001!
- View Logic ViewDraw
- Quadcept
- Zuken CadStar 3 and 4
- Zuken CR-5000 and CR-8000

PCB Component Libraries (EDA), PCB CAD Library Ultra Librarian

CAD data

2D/3D Models 255-612

[URL](#)

[Download](#)

Environmental Product Compliance

Compliance Search

Environmental Product Compliance 255-612

[URL](#)

[Download](#)

PCB terminal block; push-button; 2.5 mm²; Pin spacing 10/10.16 mm; 12-pole; CAGE CLAMP®; commoning option; 2,50 mm²; gray

Subject to changes. Please also observe the further product documentation!

WAGO GmbH & Co. KG
Hansastr. 27
32423 Minden
Phone: +49571 887-0 | Fax: +49571 887-169
Email: info.de@wago.com | Web: www.wago.com

Do you have any questions about our products?
We are always happy to take your call at +49 (571) 887-44222.

Installation Notes

Conductor termination

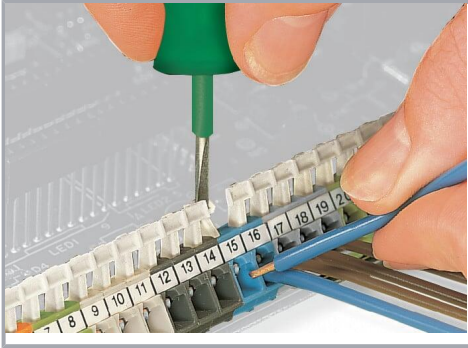

Inserting/removing a conductor – 256 Series.

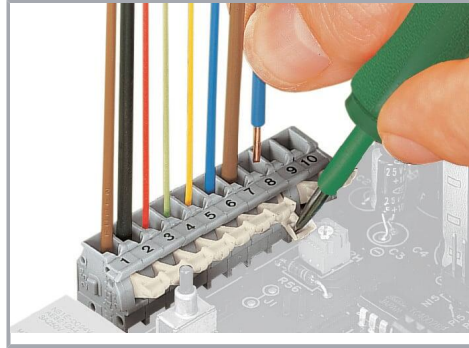

Inserting/removing a conductor (255 Series)

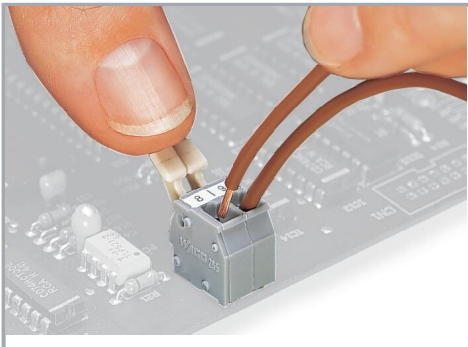

Inserting/removing a conductor via finger-operated lever – 255 Series.

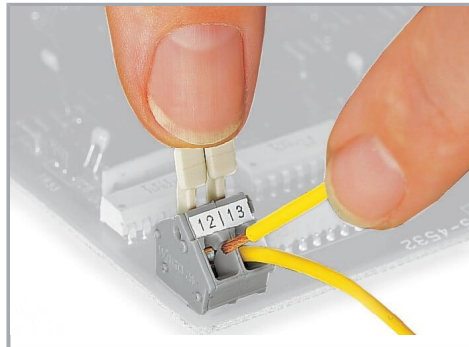

Inserting/removing a conductor via finger-operated lever – 256 Series.

Installation

Subject to changes. Please also observe the further product documentation!

WAGO GmbH & Co. KG
Hansastr. 27
32423 Minden
Phone: +49571 887-0 | Fax: +49571 887-169
Email: info.de@wago.com | Web: www.wago.com

Do you have any questions about our products?
We are always happy to take your call at +49 (571) 887-44222.

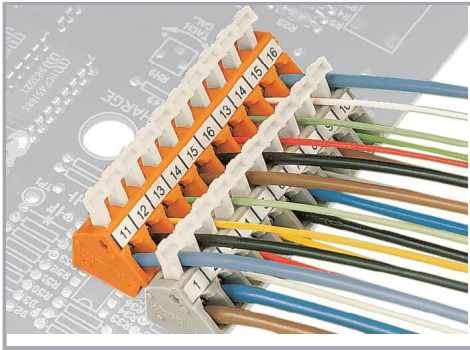

Possible conductor arrangement with terminal strips staggered (for 256 Series only).

Marking



Formation of groups using housings of different colors

Testing

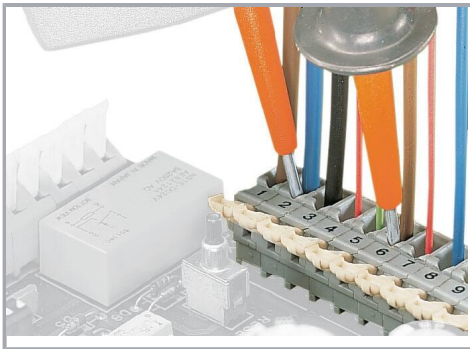

Testing with test probes.

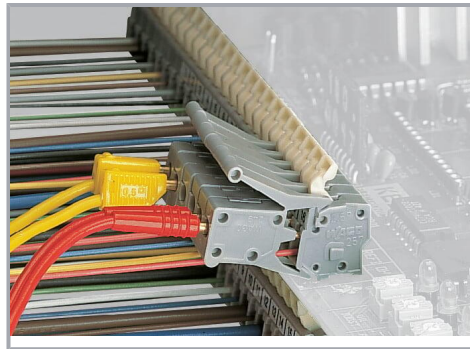

Testing with test plug modules.

Subject to changes. Please also observe the further product documentation!