



---

---

# THETIS-I EVALUATION KIT USER MANUAL

---

---

## FOR RADIO MODULES

EV Order Code	Module order code	Product Name
2611019021011	2611011021010	Thetis-I

VERSION 1.2

JULY 30, 2021

\*\*\*\*\*

## **MUST READ**

### **Check for firmware updates**

Before using the product make sure you use the most recent firmware version, data sheet and user manual. This is especially important for Wireless Connectivity products that were not purchased directly from Würth Elektronik eiSos. A firmware update on these respective products may be required.

We strongly recommend to include in the customer system design, the possibility for a firmware update of the product.

## Revision history

Manual version	Notes	Date
1.0	<ul style="list-style-type: none"><li>• Initial version</li></ul>	March 2021
1.1	<ul style="list-style-type: none"><li>• Extended functional description of sensor nodes with Chapters 5.6.2 and 5.6.3.</li><li>• Added and replaced product images in Chapter 1.</li></ul>	May 2021
1.2	<ul style="list-style-type: none"><li>• Added Chapter Distance between the nodes.</li></ul>	July 2021

## Abbreviations and abstract

Abbreviation	Name	Description
API	Application Programming Interface	
ASCII	American Standard Code For Information Interchange	
COG	Chip on Glass	
COM Port	Communication Port	
CSAP	Configuration Service Access Point	UART control command for module configuration
DSAP	Data Service Access Point	UART control command for radio data transmission and reception
EV	Evaluation	
ESD	Electro Static Discharge	
FCC	Federal Communications Commission	
FTDI	Future Technology Devices International	USB-to-Serial converter chip
GND	Ground	Ground signal level that corresponds to 0 V
HIGH	High signal level	
IO	Input & Output	
JTAG	Joint Test Action Group	
LDO	Low Dropout	
LED	Light Emitting Diode	
LFCLK	Low frequency clock	
LFXO	Low frequency crystal oscillator	
LOW	Low signal level	
MCU	Micro Controller Unit	
MSAP	Management Service Access Point	UART control command for module management
NPO	Negative-Positive 0	
OTA	Over the air	
PC	Personal Computer	
PCB	Printed Circuit Board	
RF	Radio frequency	Describes everything relating to the wireless transmission.
RSVD	Reserved	
SMA	SubMiniature version A	
SMD	Surface-Mount Device	
SWD	Serial Wire Debug	

THT	Through-hole technology	
TTL	Transistor-Transistor Logic	
UART	Universal Asynchronous Receiver Transmitter	Universal Asynchronous Receiver Transmitter allows communicating with the module of a specific interface.
USB	Universal Serial Bus	
VDD	Voltage Drain Drain	Supply voltage
WE	Würth Elektronik	

# Contents

<b>1</b>	<b>Supported radio modules</b>	<b>6</b>
1.1	Wirepas™ technology . . . . .	7
<b>2</b>	<b>Functional description</b>	<b>8</b>
2.1	Distance between the nodes . . . . .	9
2.2	Taking into operation . . . . .	11
<b>3</b>	<b>Development board - Thetis-I mini evaluation board</b>	<b>14</b>
3.1	Block diagram . . . . .	14
3.2	Functional description . . . . .	15
3.3	Connectors and pin headers . . . . .	16
3.3.1	P1, P2, P3: Module access pins . . . . .	18
3.3.2	P3: TTL-232R-3V3 FTDI cable connector . . . . .	18
3.3.3	P4, P5: Alternative power supply connection . . . . .	19
3.3.4	JTAG Debugging Interface . . . . .	19
3.3.5	SMA . . . . .	20
3.4	Jumpers . . . . .	22
3.4.1	JP1 . . . . .	23
3.4.1.1	JP1: Power LED separation . . . . .	23
3.4.1.2	JP1: Power supply selection . . . . .	23
3.5	Reset button . . . . .	24
3.6	Function blocks . . . . .	25
3.6.1	Power supply . . . . .	25
3.6.1.1	Connector P3, power supply through TTL-232R-3V3 . . . . .	25
3.6.1.2	Connector P3, power supply through external source . . . . .	25
3.6.1.3	Connectors P4 and P5, power supply through external source . . . . .	25
3.6.2	UART / USB . . . . .	25
3.6.3	UART direct . . . . .	25
3.6.4	LFXO crystal . . . . .	26
3.6.4.1	LFXO Design guidelines . . . . .	27
3.6.5	Programming interface . . . . .	27
3.7	Schematic . . . . .	28
3.8	Layout . . . . .	29
3.9	Bill of materials . . . . .	31
<b>4</b>	<b>Development board - Thetis-I USB radio stick</b>	<b>32</b>
4.1	Block diagram . . . . .	32
<b>5</b>	<b>Development board - Thetis-I sensor node</b>	<b>33</b>
5.1	Block diagram . . . . .	33
5.2	Connectors and pin headers . . . . .	34
5.2.1	J2: Alternative power supply connection . . . . .	35
5.3	Battery holder for CR2032 coin cell . . . . .	35
5.4	Reset button . . . . .	36
5.5	Function blocks . . . . .	37
5.5.1	Power supply . . . . .	37
5.5.2	Undervoltage supervisor . . . . .	37
5.5.3	LED . . . . .	37
5.5.4	Low frequency crystal . . . . .	37

5.5.5	Sensor . . . . .	38
5.6	Functional description . . . . .	39
5.6.1	Configuration of the update interval and data format . . . . .	39
5.6.2	Configuration of Wirepas node settings, like node role . . . . .	41
5.6.3	Reading a Wirepas node setting . . . . .	43
5.7	Schematic . . . . .	44
5.8	Layout . . . . .	45
5.9	Optional enclosure mounting . . . . .	47
5.10	Bill of materials . . . . .	48
<b>6</b>	<b>Würth Elektronik eiSos test network</b>	<b>49</b>
<b>7</b>	<b>References</b>	<b>52</b>
<b>8</b>	<b>Regulatory compliance information</b>	<b>53</b>
8.1	European Conformity . . . . .	53
8.2	FCC . . . . .	53
8.3	Exemption clause . . . . .	53
<b>9</b>	<b>Important notes</b>	<b>54</b>
9.1	General customer responsibility . . . . .	54
9.2	Customer responsibility related to specific, in particular safety-relevant applications . . . . .	54
9.3	Best care and attention . . . . .	54
9.4	Customer support for product specifications . . . . .	54
9.5	Product improvements . . . . .	55
9.6	Product life cycle . . . . .	55
9.7	Property rights . . . . .	55
9.8	General terms and conditions . . . . .	55
<b>10</b>	<b>Legal notice</b>	<b>56</b>
10.1	Exclusion of liability . . . . .	56
10.2	Suitability in customer applications . . . . .	56
10.3	Trademarks . . . . .	56
10.4	Usage restriction . . . . .	56
<b>11</b>	<b>License terms</b>	<b>58</b>
11.1	Limited license . . . . .	58
11.2	Usage and obligations . . . . .	58
11.3	Ownership . . . . .	59
11.4	Firmware update(s) . . . . .	59
11.5	Disclaimer of warranty . . . . .	59
11.6	Limitation of liability . . . . .	59
11.7	Applicable law and jurisdiction . . . . .	60
11.8	Severability clause . . . . .	60
11.9	Miscellaneous . . . . .	60

# 1 Supported radio modules

The evaluation kit described in this manual is exclusively for the Thetis-I module [4]:

Order code	Product Name	Description
2611011021010	Thetis-I	Wirepas Mesh 2.4 GHz radio module with smart antenna configuration

Order code	Product Name
2611019021011	Thetis-I Wirepas Mesh EV-kit

Table 1: Compatibility

Kit Content 2611019021011	Order code	Quantity
Thetis-I mini evaluation board	2611109021011	1
Thetis-I USB radio stick	2611086021011	1
Thetis-I sensor node	2611097021021	3
Packaging: Cardboard Box, ESD safe cover		1

Table 2: Content Thetis-I Wirepas EV-kit



Connection cables and batteries are not included in the evaluation kit.



If a larger Wirepas test network is required, more pieces of the Thetis-I mini evaluation board, USB radio stick and sensor node can be purchased separately ([wireless-sales@we-online.com](mailto:wireless-sales@we-online.com))



Figure 1: Thetis-I USB radio stick: product image



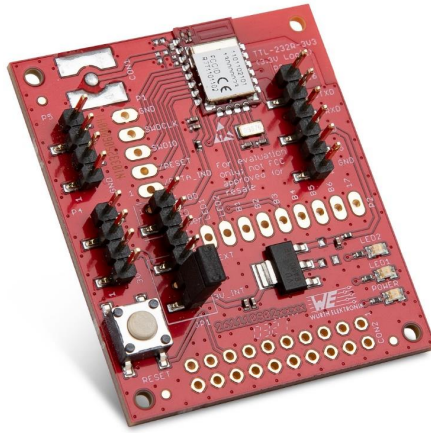

Figure 2: Thetis-I mini evaluation board: product image

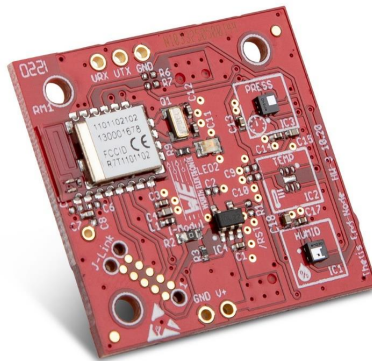

Figure 3: Thetis-I sensor node: product image

## 1.1 Wirepas™ technology

As an official partner of Wirepas™, Würth Elektronik eiSos is authorized to make commercial use of Wirepas firmware for the purposes of normal business.

## 2 Functional description

The Thetis-I Evaluation Kit offers the user the possibility to set up and evaluate a Wirepas prototype network.

The goal of the kit is to use the Thetis-I mini evaluation board for the development of the end device. For a quick start the mini evaluation board and the Windows PC tool Wirepas Commander [5] can be used to push arbitrary custom data into the network, that is collected by the Wirepas sink device (Thetis-I USB radio stick).

Besides of that, the provided sensor nodes can be added to the Wirepas mesh network to perform an analysis of a realistic mesh network behaviour (i.e. timings, workload, connection setup, energy estimations, etc.).

In the second step, a custom host micro controller can be attached to the Thetis-I mini evaluation board to develop the end device.

The Thetis-I Evaluation Kit consists of:

- one Thetis-I mini evaluation board, that is able to transfer user payload data into the network via the connected host (microcontroller or PC);
- one Thetis-I USB radio stick [3], that will be the sink device of the Wirepas network;
- three Würth Elektronik eiSos Wirepas sensor nodes, that will repeatedly transmit sensor data to the sink device on radio channel 39 and network ID 7;

The network can be enlarged by purchasing additional pieces of any of the components (USB radio stick, mini evaluation board, sensor node).

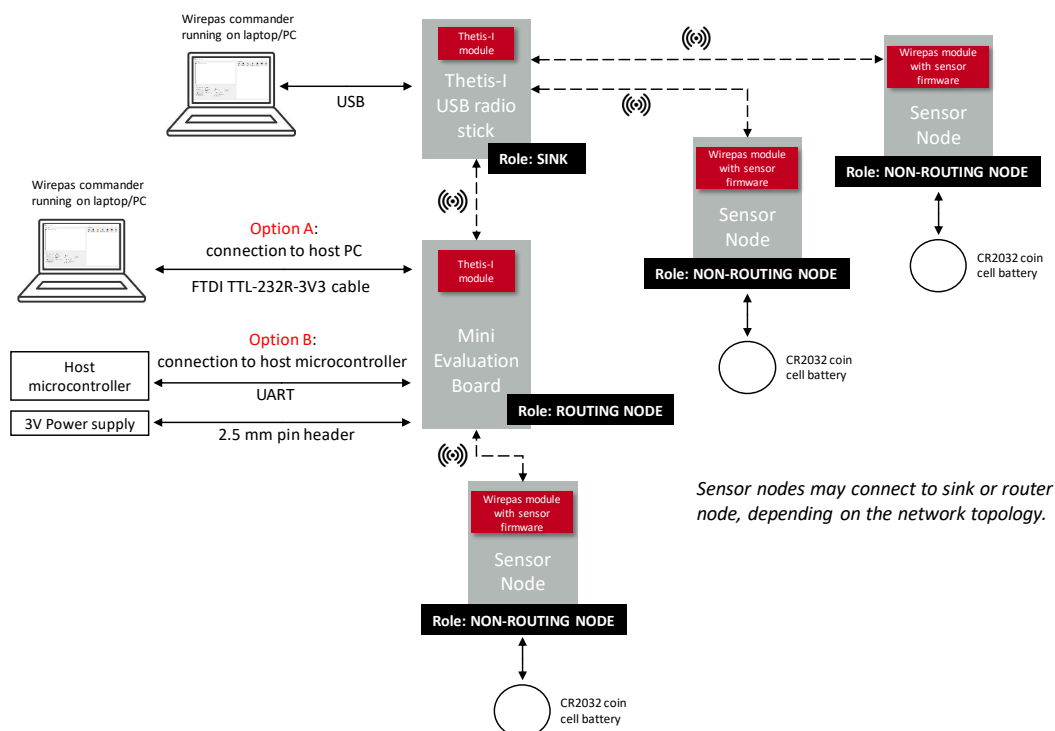

Figure 4: Network setup

## 2.1 Distance between the nodes

In order to interconnect the elements of the evaluation kit in a network, the distance between them should allow successful radio transmission. The maximum achievable range depends on many different factors. Some of them are shortly discussed below.

- **Transmit power and antenna.** All the Wirepas modules integrated in the hardware components of the Thetis-I Evaluation Kit (USB radio stick, mini evaluation board, sensor nodes) use their onboard PCB antenna. This allows miniaturization of the components and avoids extra power supply for an active antenna. On the other hand, the reduced maximum transmit power and sensitivity of the internal antenna solution reduces the maximum achievable range. Higher range can be achieved with the mini evaluation board, if an external active antenna is connected through the SMA connector. Please refer to Chapter 3.1.
- **Height of the antenna over the floor.** Keeping the antennas as high as possible over the floor improves the maximum achievable range. This factor might become particularly critical when using the Thetis-I radio stick directly plugged to a computer tower; for better range, a USB extension cable is recommended (see Figure 5).

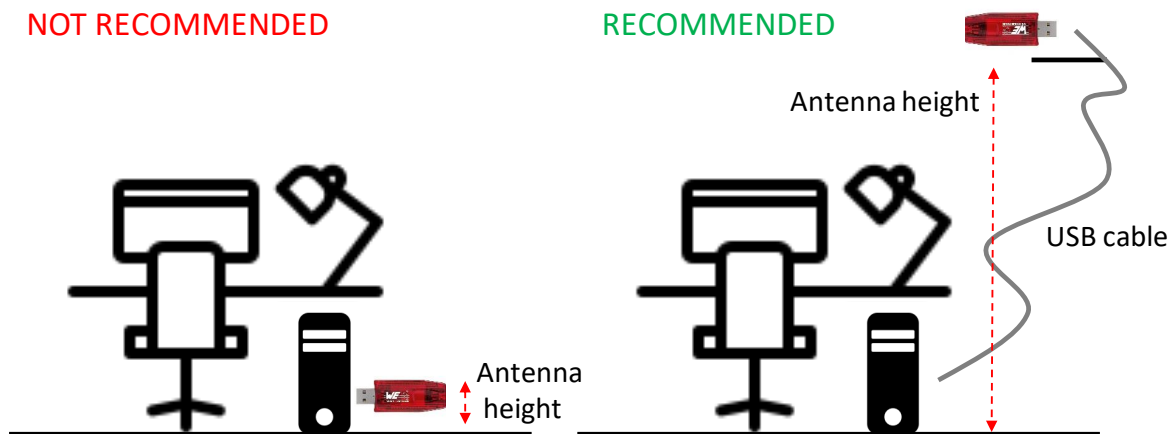

Figure 5: Placement of Thetis-I USB Radio Stick

- **Attenuation due to the environment.** Typical obstacles of an indoor environment (walls, doors, etc.) and consequent reflections and attenuations reduce the achievable range. They can be decisive factors in whether a connection to the neighbor node can be established or not.

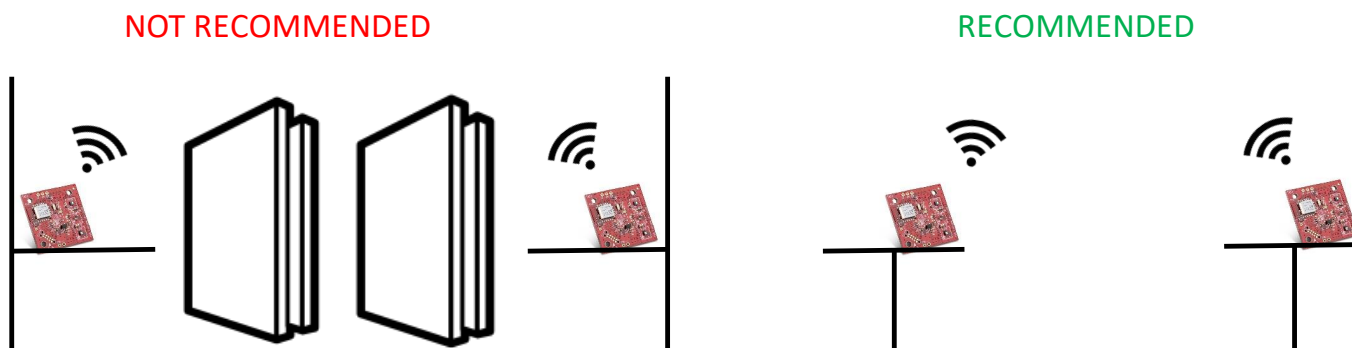

Figure 6: Connection between nodes

In addition to that, and although the Wirepas nodes look for the best frequency channel to use, other transmitters in the 2.4 GHz frequency band placed in the proximity of the Wirepas nodes might interfere with the radio communication. Please ensure that they are switched off or not placed in the proximity of the Wirepas devices.

The default role of the sensor nodes is router node with automatic role selection. In order to minimize the energy consumption, the nodes will route messages from other nodes only if strictly required. This decision is made automatically by the node.



Nodes working in non-routing mode do not contribute in covering the distance between other nodes and the sink.

If the positions of the nodes in the network change, the nodes could update the decision and automatically change role.



It might require some time until the node roles are automatically adjusted to the new positions!

To be sure that the nodes route messages from other nodes, the role "ROUTING NODE" needs to be set (please refer to Chapter 2.2 and 5.6.2).



Due to the strong impact on the energy consumption, this is recommended rather on the mini evaluation board than on the sensor nodes.

In order to cover longer distances, the test network can be enlarged with additional pieces of any of the components of the evaluation kit.

NOT RECOMMENDED

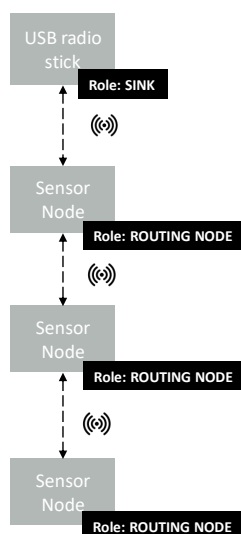

RECOMMENDED

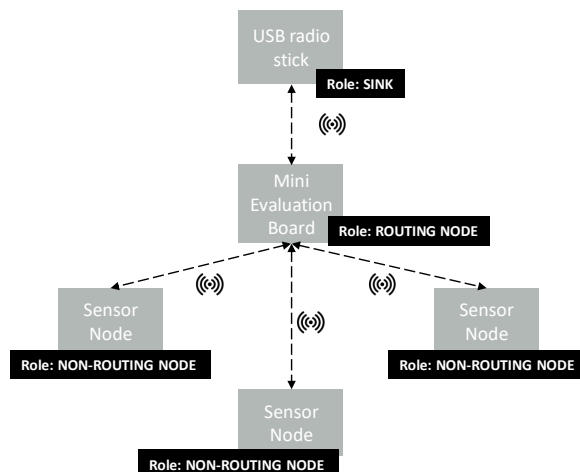

Figure 7: Roles and position of the devices

## 2.2 Taking into operation

To create a local Wirepas network out of the evaluation kit please perform the following steps:

1. Download the Wirepas Commander PC Tool [5].
2. Setup the sink
  - a) Connect the Thetis-I USB radio stick to a Windows PC.
  - b) Start the Wirepas Commander PC tool.
  - c) Select the right COM port of the Thetis-I USB radio stick and press the "Open/Close COM port" button.

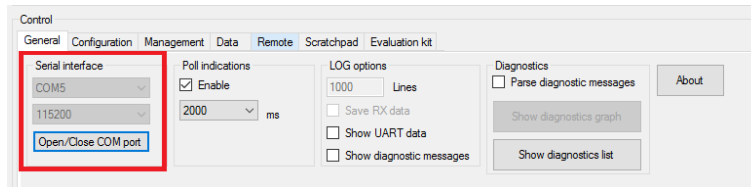

Figure 8: Open COM port

- d) Configure the connected Thetis-I USB radio stick to match the needs of your Wirepas mesh network. Thus go to the tab "Configuration" and set:
  - the node address to a unique address.
  - the address of the network to 7.
  - the channel of the network to 39.
  - the node role to "SINK".

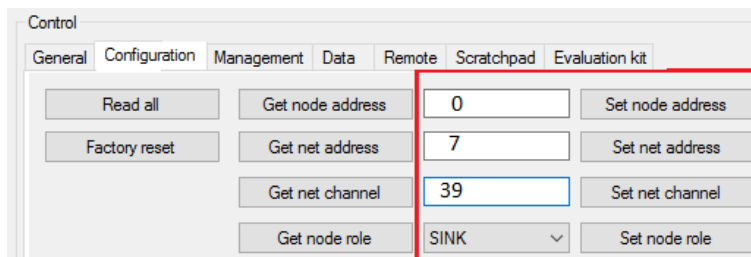

Figure 9: Configure the sink

- e) Proceed by starting the radio stack in the tab "Management".

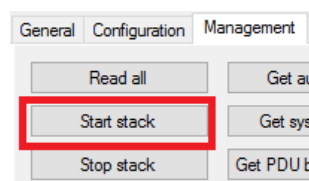

Figure 10: Start the sink

3. Starting the Wirepas sensor nodes. Please do the following process with all of the provided sensor nodes:
  - a) Place a coin cell in the battery holder of the sensor node.
  - b) As soon as the Wirepas sensor node is power sourced, its LED will start blinking until connection to the sink device (Thetis-I USB radio stick) is established.

- c) After the connection to the sink has been established, the Wirepas sensor node will send its sensor data to the sink each 60 s. The Wirepas Commander PC tool, that is connected to the sink, will print these radio messages in its message window.

```

Wirepas Module Commander 1.0.0.0 connected to port COM51

Status window
[10-31-44.549] Started Wirepas Module Commander
Version 1.0.0.0
[10-31-48.914] COM Port opened.
[10-31-48.952] MSAP_STACK_STATE_INDICATION status 0
[10-32-17.163] SUCCESS: Reading CSAP attribute node role
[10-32-27.584] DSAP_DATA_RX_INDICATION from address (1042331845,1) to address (1,2) Number of hops 1 / Travel time 9.53125s
Data = 0x4E 6F 64 65 20 77 69 74 68 20 49 44 20 31 30 34 32 33 33 31 38 34 35 20 28 30 78 33 45 32 30 42 38 43 35 29 20 2F 20 4E 65 74 77 6F 72 68 20 49 44 20 32 20 72 75 6E 6E 69 6E 67 20 77 69 74 68 20 66 69 72 6D 77 61 72
65 20 76 65 72 73 69 6F 6E 20 30 2E 30 2E 31 30 (Ascii = Node with ID 1042331845 (0x3E20B8C5) / Network ID 2 running with firmware version 0.0.10)
[10-32-27.617] DSAP_DATA_RX_INDICATION from address (1042331845,1) to address (1,2) Number of hops 1 / Travel time 9.5625s
Data = 0x54 49 44 53 3A 20 32 32 2E 39 37 27 43 (Ascii = TIDS: 22.97C)
  
```

Figure 11: Sensor data

Furthermore, the sensor data will be shown in a chart on the "Evaluation kit" tab. To interpret the data, set the interpretation dropdown box to "ON".

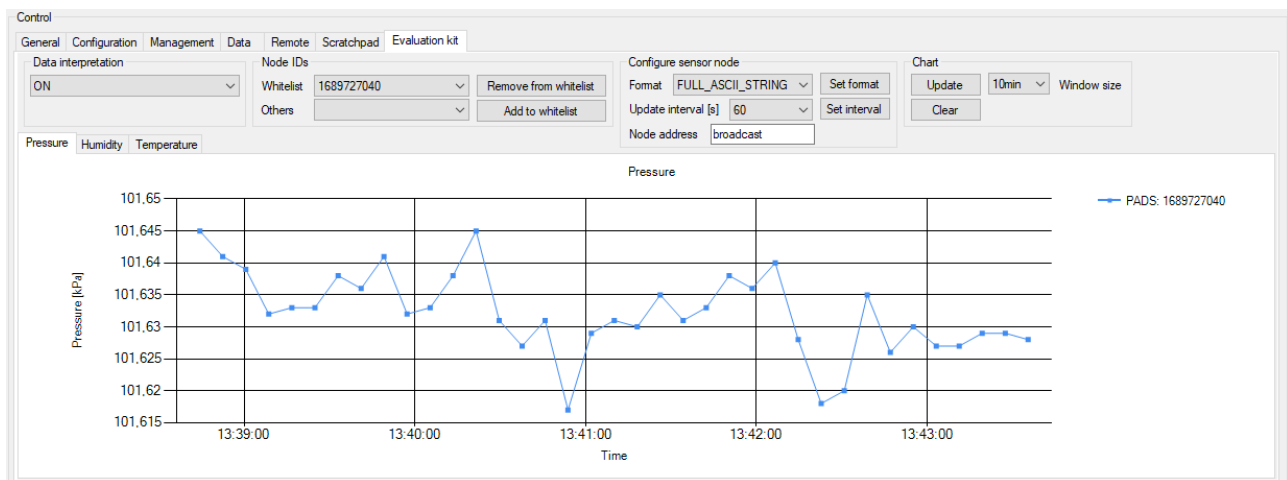

Figure 12: Sensor data chart



Please note that this chart is only compatible with the sensor nodes included in the Thetis-I EV-Kit.

For more information and examples on how to operate the sensor nodes, please refer to Chapter 5.6.

4. (Optional) Start Thetis-I mini evaluation board. The Thetis-I evaluation board needs a host that controls the function of the Thetis-I radio module. Independent of which host is chosen, the Thetis-I radio module on the Thetis-I mini evaluation board must be configured to take part at the Wirepas network consisting of the previously configured sink device and the Wirepas sensor nodes. Any micro controller or PC can be used as host.

- a) In case a Windows PC is taken as host, please connect the Thetis-I mini evaluation board via appropriate USB-to-Serial converter cable (i.e. FTDI TTL-232R-3V3) to the Windows PC. Then start a second instance of the Wirepas commander PC tool and perform the following steps.

- i. Select the right COM port of the Thetis-I evaluation board and press the "Open/Close COM port" button (see figure 8).
- ii. Configure the connected Thetis-I mini evaluation board to match the needs of your Wirepas mesh network. Thus go to the "Configuration" tab and set
  - the node address to a unique address.
  - the address of the network to 7.
  - the channel of the network to 39.
  - the node role to "ROUTER\_NODE".
- iii. Start the radio stack on the "Management" tab (see figure 10).
- iv. To transmit data from the Wirepas mini evaluation board to the sink enter the data you want to transmit in the fields of the "Data" tab. As destination node address type "sink".

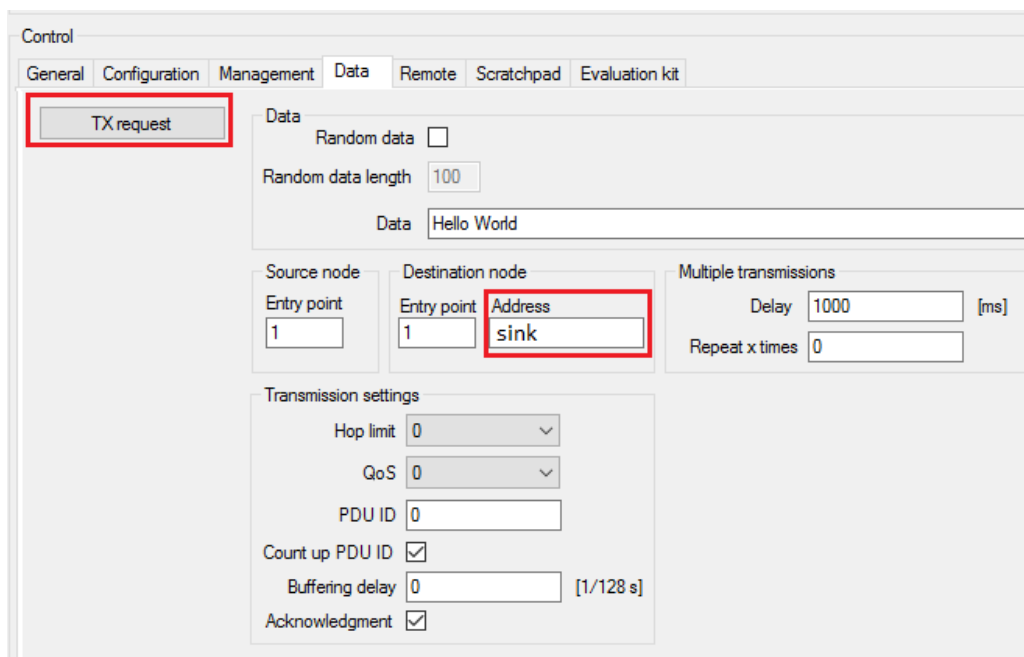

Figure 13: Transmit data to the sink

- b) In case a micro controller is used as host, connect the micro controller's UART using pin header P3. An external power supply shall be connected to the evaluation board. The power supply option 2 or 3 from the table 15 shall be used. It is important that the VDD is stable and able to reliably supply the module's static and peak current consumption as specified by the module manual. The headers P1, P2 and P3 can be used to connect the module pins to the host. Then configure the Thetis-I using the appropriate UART commands. For more details on the UART commands, please refer to the **Wirepas dual mcu manual** [1].

For a C implementation of the Wirepas Dual MCU API, please visit the following website: <https://github.com/wirepas/c-mesh-api>.

### 3 Development board - Thetis-I mini evaluation board

#### 3.1 Block diagram

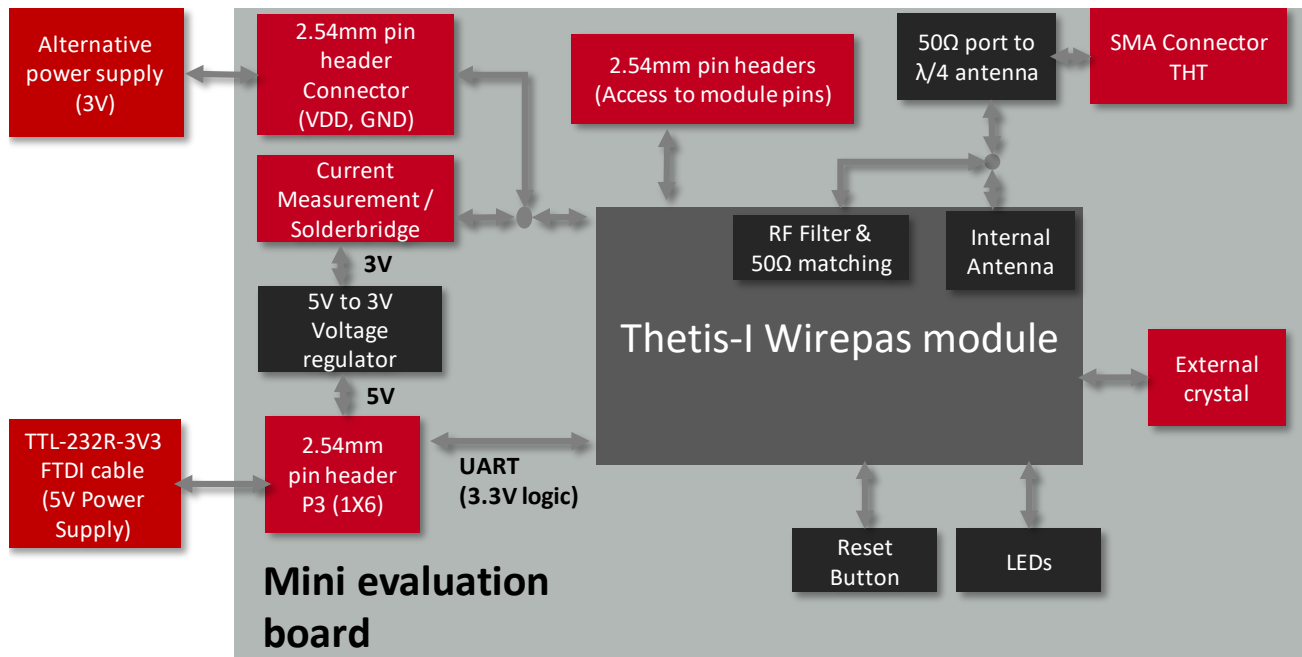

Figure 14: Block diagram



## 3.2 Functional description

The Thetis-I mini evaluation board is an application-oriented development board meant to support the rapid prototyping of a Wirepas mesh network. It offers the user the possibility to develop hardware and software for the Thetis-I Wirepas module.

By default, the basic pin headers and connectors are assembled in the mini evaluation board. The additional components shall be assembled by the user according to requirements and application.

The additional assembly is intended for experienced developers, as additional accessories and basic soldering skills are necessary to take the board into operation.

Accessories required:

- Additional assembly components listed in the table 4.
- Soldering equipment
- (Optional) TTL-232R-3V3 FTDI cable

For the connection to a micro controller or PC the evaluation board is equipped P3 Pin header which is connected to the pins of the radio module. The additional pin headers can be soldered to the placeholders to access the module pins. Jumpers allow the power selection and current measurement of the module.

The mini evaluation board can be connected to an USB port of a PC using TTL-232R-3V3 FTDI cable.

### 3.3 Connectors and pin headers

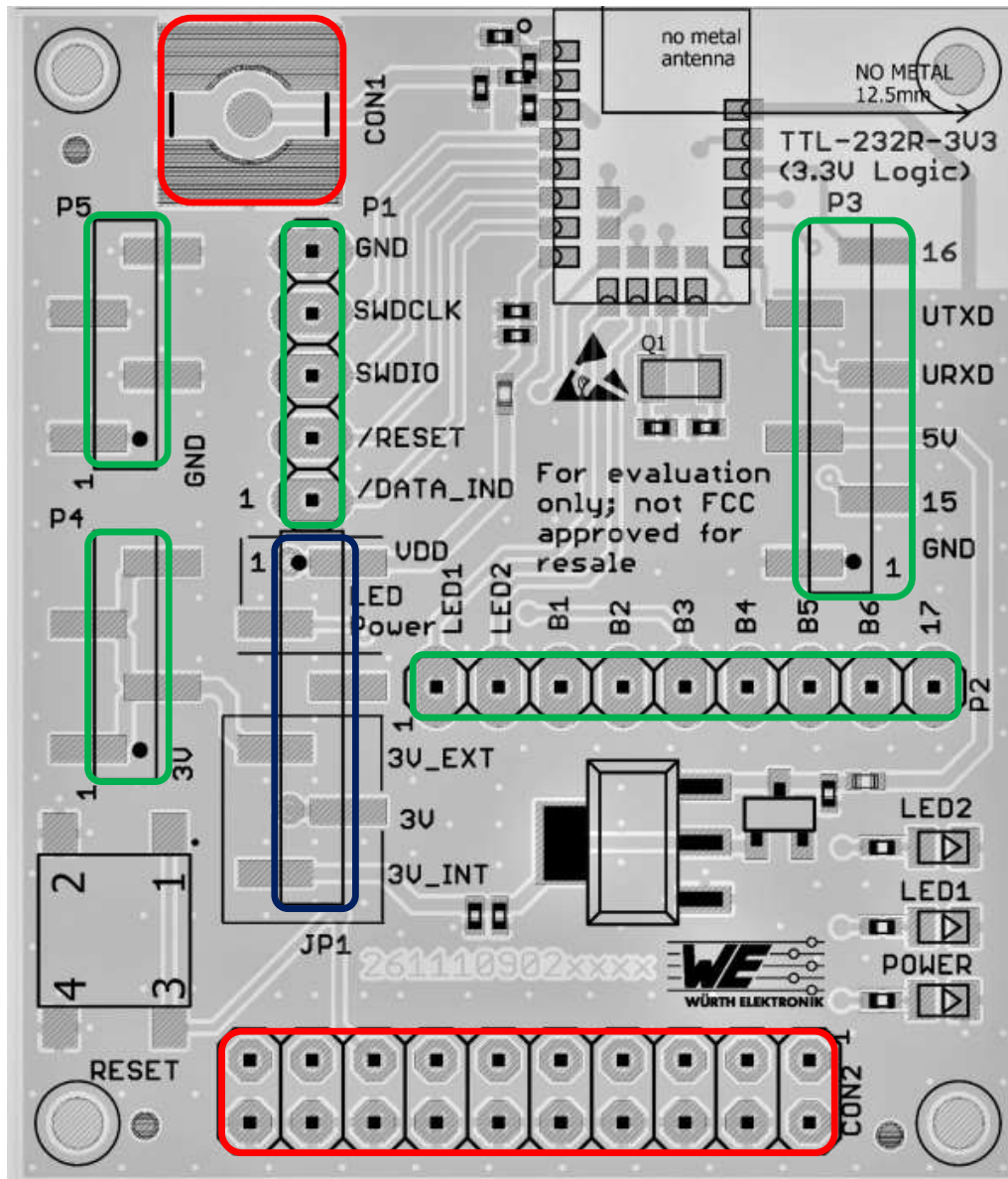

Figure 15: Connectors and pin headers

The table 3 lists the pin headers assembled on the evaluation board by default. All the components listed in the table 4 are SMD components.

Pin header	Function	Pins	WE article number
P3	TTL-232R-3V3 FTDI cable connection / Access to module pins	1X6	61000618321
P5	External power supply GND	1X4	61000418321
P4	External power supply 3V	1X4	61000418321
JP1	Power supply selection	1X6	61000618321

Table 3: Default assembled connectors

The table 4 lists the optional components for the evaluation board. Most of the components are common THT components that can be soldered on manually by the user.

Placeholder	Function	Pins	WE article number
P1	Module access pins	1X5	61300511121
P2	Module access pins	1X9	61300911121
CON1	SMA Connector	SMD	60312102114405
CON2	JTAG Connector	2X10	61302021121

Table 4: Additional assembly components



Based on the necessity the required components shall be assembled.



Holes with 2mm diameter on all the four corners are available for spacer or standoff connections

### 3.3.1 P1, P2, P3: Module access pins

P1	nRF52840	Function
1	P0.02	/DATA_IND
2	P0.18	RESET
3	SWDIO	SWDIO
4	SWCLK	SWCLK
5		GND

Table 5: Pin header P1

P2	nRF52840	Function
1	P0.19	LED1
2	P0.22	LED2
3	P0.09	B1, RSVD
4	P0.10	B2, RSVD
5	P0.23	B3, RSVD
6	P1.00	B4, RSVD
7	P0.21	B5, RSVD
8	P0.07	B6, RSVD
9	P0.03	17, RSVD

Table 6: Pin header P2

### 3.3.2 P3: TTL-232R-3V3 FTDI cable connector

P3	nRF52840	Function
1		GND
2	P0.11	15, RSVD
3		5V
4	P1.09	URXD
5	P1.08	UTXD
6	P0.12	16, RSVD

Table 7: Pin header P3



Pin header P3 is used to connect the TTL-232R-3V3 FTDI cable. P3 can also be used for direct host connection.

### 3.3.3 P4, P5: Alternative power supply connection

P4	Connection
1,2,3,4	3V External power supply

Table 8: Pin header P4

P5	Connection
1,2,3,4	GND

Table 9: Pin header P5

All the information related to the power supply are described in the chapter 3.6.1.

### 3.3.4 JTAG Debugging Interface

JTAG Pin	Function	JTAG Pin	Function
1	VDD	2	Not connected
3	Not connected	4	GND
5	Not connected	6	GND
7	SWDIO	8	GND
9	SWCLK	10	GND
11	Not connected	12	GND
13	Not connected	14	GND
15	RESET	16	GND
17	Not connected	18	GND
19	Not connected	20	GND

Table 10: JTAG debugging interface

### 3.3.5 SMA

In order to use an external antenna, the SMA connector and relevant capacitors shall be assembled. The 2.4GHz antenna Himaia from Würth Elektronik eiSos (order code 2600130021) is a perfect match: [https://www.we-online.de/katalog/en/WIRL\\_ACCE\\_2600130021](https://www.we-online.de/katalog/en/WIRL_ACCE_2600130021)



By default the internal PCB antenna of the module is used.

SMA	Connection
Inner	Module RF pin
Outer	GND

Table 11: Pin header SMA



In order to use an external SMA antenna, 22 pF capacitor (0402) on position C1 shall be assembled. C2, C8, C11 and C12 should be left unpopulated.



Optional: Experts have the possibility to use C11, C1 and C8 for additional filtering or fine tuning.

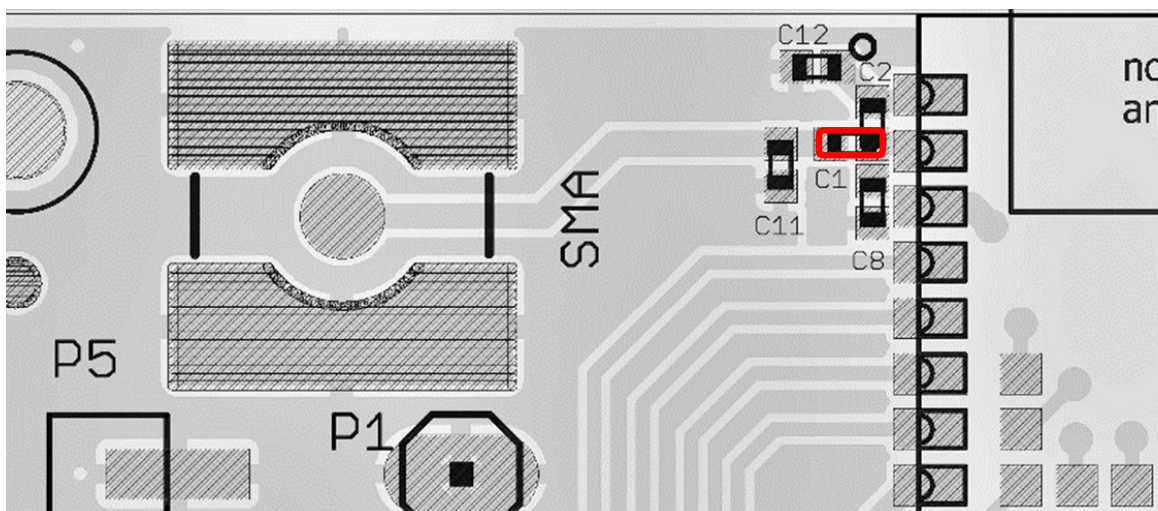

Figure 16: Capacitor connection to external antenna

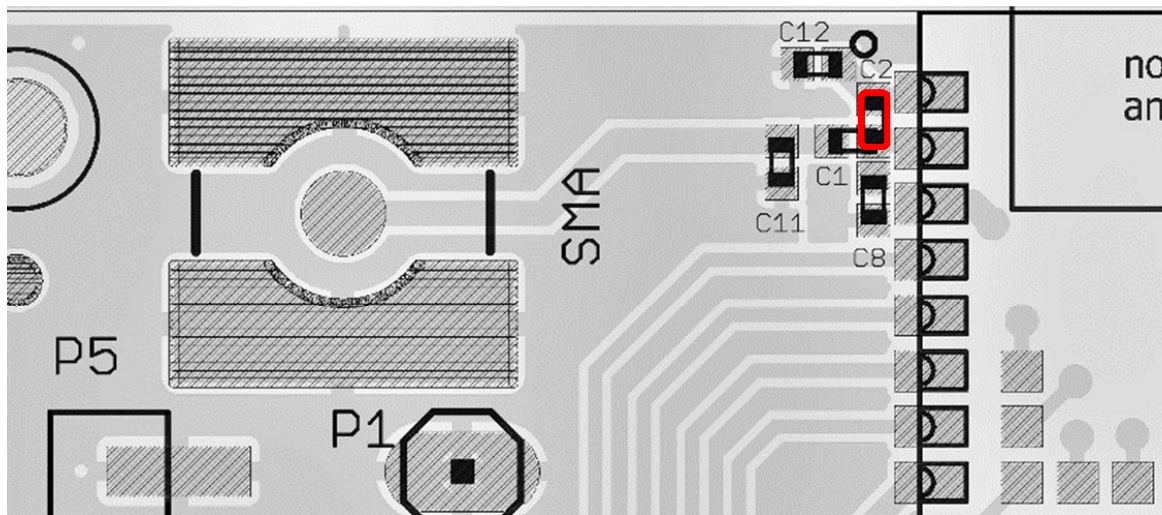

Figure 17: Capacitor connection to internal antenna



In order to use the internal PCB antenna of the module, a 22 pF capacitor (0402) on position C2 shall be assembled. C1, C8, C11 and C12 should be left unpopulated.



Optional: Experts have the possibility to use C2, C8 and C12 for additional filtering or fine tuning.

### 3.4 Jumpers

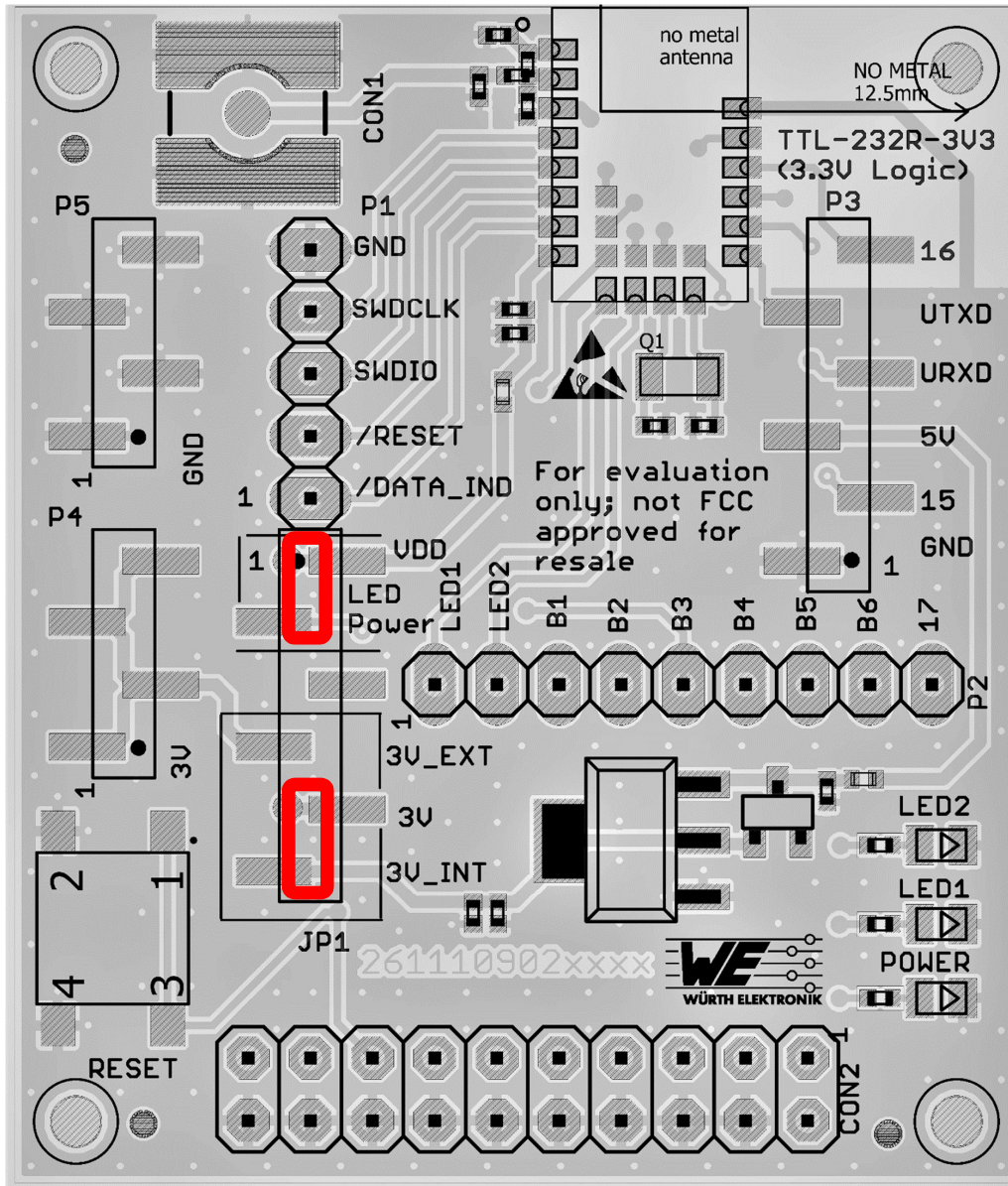

Figure 18: Jumpers



### 3.4.1 JP1

JP1 pin header is assembled by default.

JP1	Function
1	VDD
2	LED Power
3	Not connected
4	3V LDO Output
5	VDD
6	3V External Power supply

Table 12: Pin header JP1

#### 3.4.1.1 JP1: Power LED separation

JP1	Function	Jumper set(default)
1<->2	Power LED sourced by VDD	Yes

Table 13: Pin header JP1 Power LED

#### 3.4.1.2 JP1: Power supply selection

JP1 shall be set to choose either internal on-board LDO or the external 3V as power supply.



The power LED is connected to the VDD line by the 1-2 pins of JP1. To measure module current consumption, the jumper JP1 (1<->2 pins) shall be removed.

JP1	Function	Jumper set(default)
4<->5	External 3V power supply	No
5<->6	Internal LDO power supply	Yes

Table 14: Pin header JP1 Power supply selection



On JP1 a current meter shall be connected instead of a jumper to measure the current consumption of the module.

### 3.5 Reset button

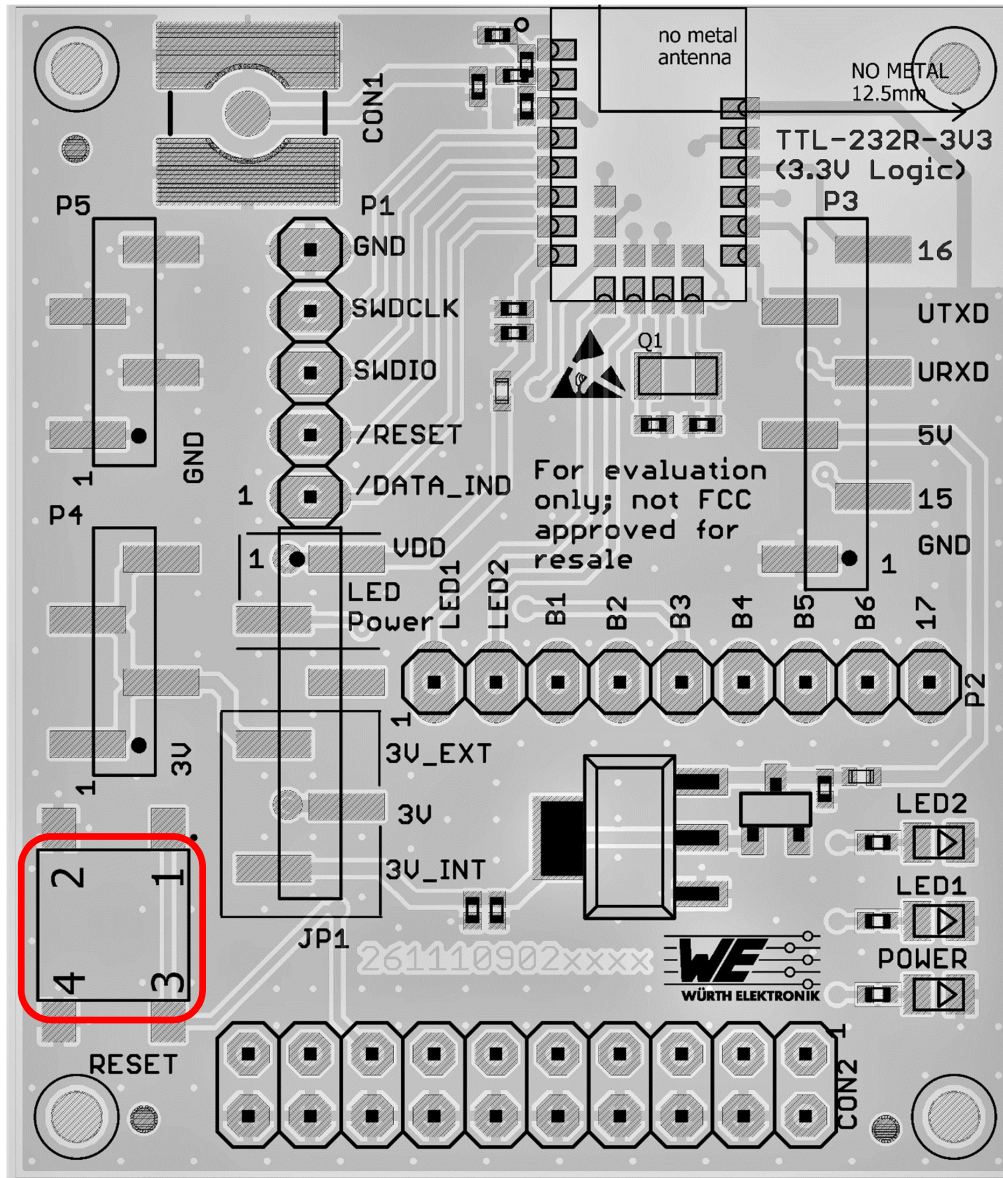

Figure 19: Buttons

On IC level the active low reset input is configured with a pull up resistor. The module provides a `/RESET` pin that is connected to this button so that the module can be restarted properly.

## 3.6 Function blocks

### 3.6.1 Power supply

The mini evaluation board can be powered either by TTL-232R-3V3 cable or by an external power supply. The table 15 lists the connection for different power supply options.

Nr.	Power supply	Connector	JP1 Jumper
1	TTL-232R-3V3 cable	P3	Pin (5<->6)
2	External supply	P3 Pin-3 (5V) P3 Pin-1 (GND)	Pin (4<->5)
3	External supply	P4 (3V) and P5 (GND)	Pin (4<->5)

Table 15: Power supply option

#### 3.6.1.1 Connector P3, power supply through TTL-232R-3V3

The evaluation board can be sourced by TTL-232R-3V3 cable through P3 connector. The TTL-232R-3V3 cable powers the board with 5 V supply. The integrated voltage regulator regulates the connected voltage 5 V down to 3 V and supplies the remaining parts of the circuit. If the module is sourced, the *Power LED* lights up.

#### 3.6.1.2 Connector P3, power supply through external source

The evaluation board can be sourced by an external power supply through the P3 connector Pin-3 (5V) and P3 Pin-1 (GND). If the module is sourced, the power *Power LED* lights up.

#### 3.6.1.3 Connectors P4 and P5, power supply through external source

The development board can be sourced by an external power supply through the P4 (1.9-3.6 V) and P5 (GND) connector. If the module is sourced, the *Power LED* lights up.

### 3.6.2 UART / USB

The TTL-232R-3V3 cable is used for USB/UART connection between PC and the evaluation board. The IO level of the TTL-232R-3V3 cable is 3.3 V. Using the FTDI-driver the PC will show a virtual COM port which can be used to communicate with the module.

### 3.6.3 UART direct

P3 connector shall be used for host connection. The UART of the host can be directly connected to P3 (pins are labelled on the evaluation board). The module *RXD* line must be handled accordingly by your host (i.e. pulled up while inactive and during module boot-up). Beware of IO level compatibility. The host must obey the values stated in the module's manual. Especially the IO level restrictions must be implemented by a host system (i.e. using a level shifter to use the allowed IO levels).

### 3.6.4 LFXO crystal

For higher LFCLK accuracy (better than  $\pm 250$  ppm) a low frequency crystal oscillator of 32.768 kHz (LFXO) shall be used. A crystal, 3.2 × 1.6 mm package, order code 830009706 with capacitors C9 (12 pF) and C10 (12 pF), 0402 package is used in the reference design.

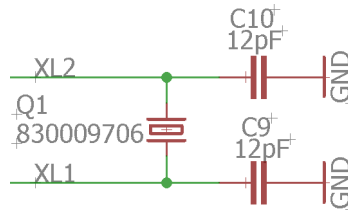

Figure 20: LFXO

Depending on parasitic capacitance of PCB, the capacitance value of C9 and C10 shall be calculated.

nRF52840 pin P0.00/XL1 and P0.01/XL12 are connected to module pad XL1 and XL2 respectively.

The input capacitance of the pad XL1 and XL2 are 4 pF. The values of C9 and C10 can be calculated as follows.

The load capacitance of LFXO is given by

$$C_l = \frac{C9_l * C10_l}{C9_l + C10_l} \quad (1)$$

If  $C9_l = C10_l = C$ , then

$$C_l = \frac{C}{2} \quad (2)$$

whereas,

$$C9 = C - C_{XL1} - C_{PCB} \quad (3)$$

$$C10 = C - C_{XL2} - C_{PCB} \quad (4)$$

$C_l$  = Load capacitance of LFXO crystal.

$C_{XL1}$  = Input capacitance of Pad XL1 (4pF)

$C_{XL2}$  = Input capacitance of Pad XL2 (4pF)

$C_{PCB}$  = Parasitic capacitance of PCB

Parasitic capacitance of the PCB can vary depending on design and track length. Typical values for parasitic capacitors range from 0.5 pF to 2 pF.

For the crystal 830009706 with load capacitance of 9 pF and parasitic capacitance of 2 pF (for the Thetis-I Mini EV board), the value of C9 and C10 results in 12 pF, which was also tested on the Thetis-I Mini EV board.

### 3.6.4.1 LFXO Design guidelines

1. LFXO shall be placed away from high frequency components and traces.
2. The ground connection for the load capacitor shall be short using ground vias.
3. The crystal shall be placed close to the module.
4. PCB traces between module and the crystal shall be kept short.
5. Load capacitors shall be low leakage and temperature stable (NPO or COG) type.
6. The differential traces shall be kept to the same length.
7. Ground area shall be placed under the crystal and connected to the main ground plane.
8. Open traces to the pins shall be avoided to reduce parasitic capacitance and coupling effects.
9. Ground area shall be used between the crystal traces and other PCB traces for better decoupling.

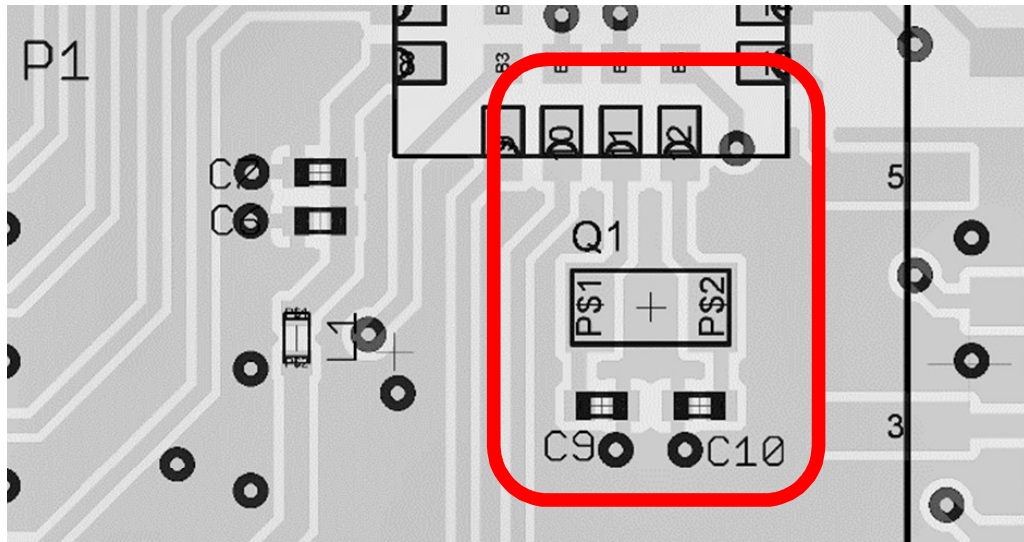
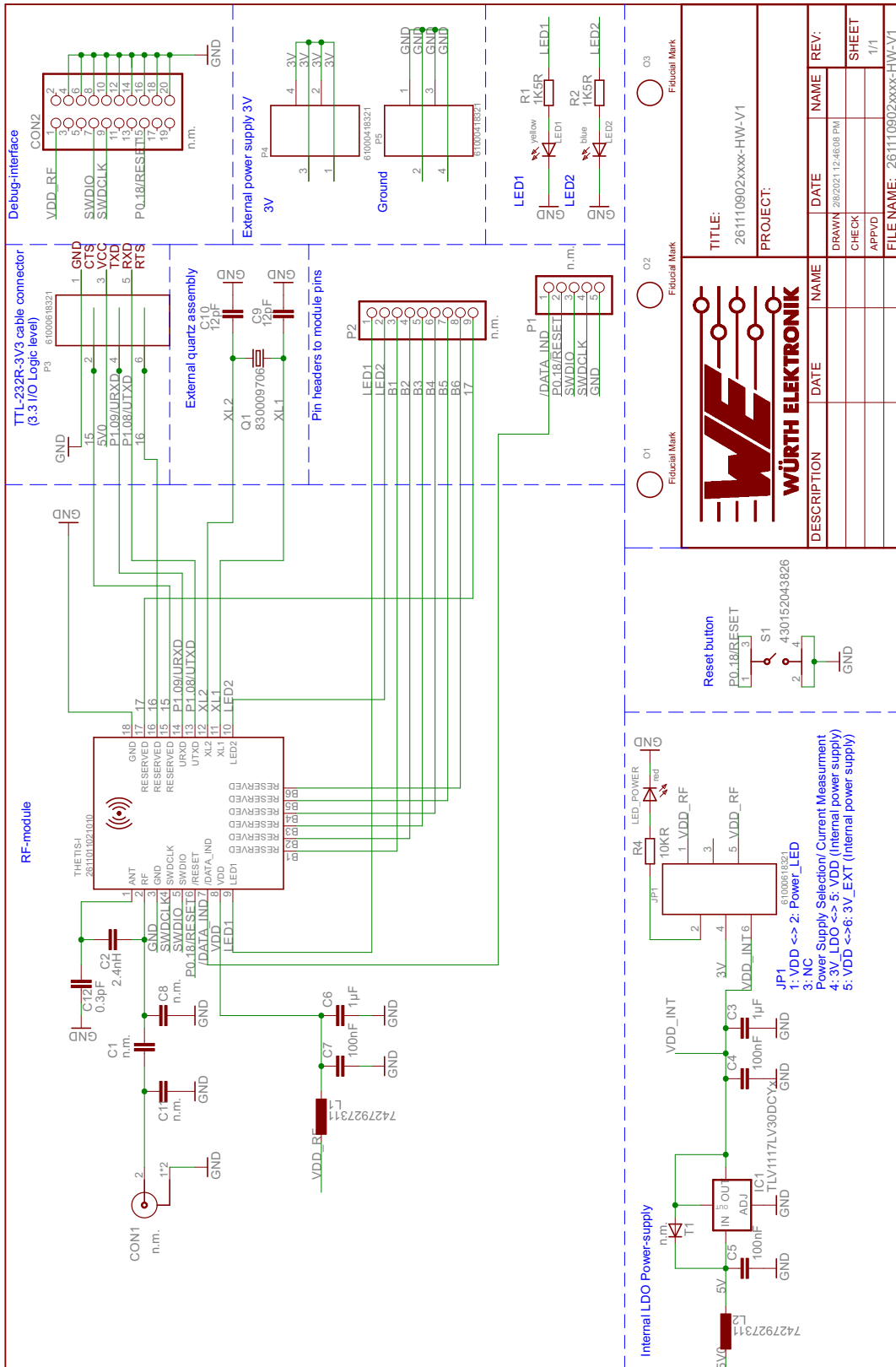

Figure 21: LFXO assembly

### 3.6.5 Programming interface

The evaluation board provides a place holder for 2×10 pin connector CON2. It can be used to connect directly to a JTAG flash adapter used for development. Please take care of the correct mounting of the flash adapter. The recommended flash adapter is one of the "Segger J-Link" family.

### 3.7 Schematic



		TITLE:		261110902xxxx-HW-V1	
		PROJECT:			
DESCRIPTION	DATE	NAME	DATE	NAME	REV.
			DRAWN		28/02/21 12:46:08 PM
			CHECK		
			APPVD		
			FILE NAME:	261110902xxxx-HW-V1	

Figure 22: Schematic sheet

### 3.8 Layout

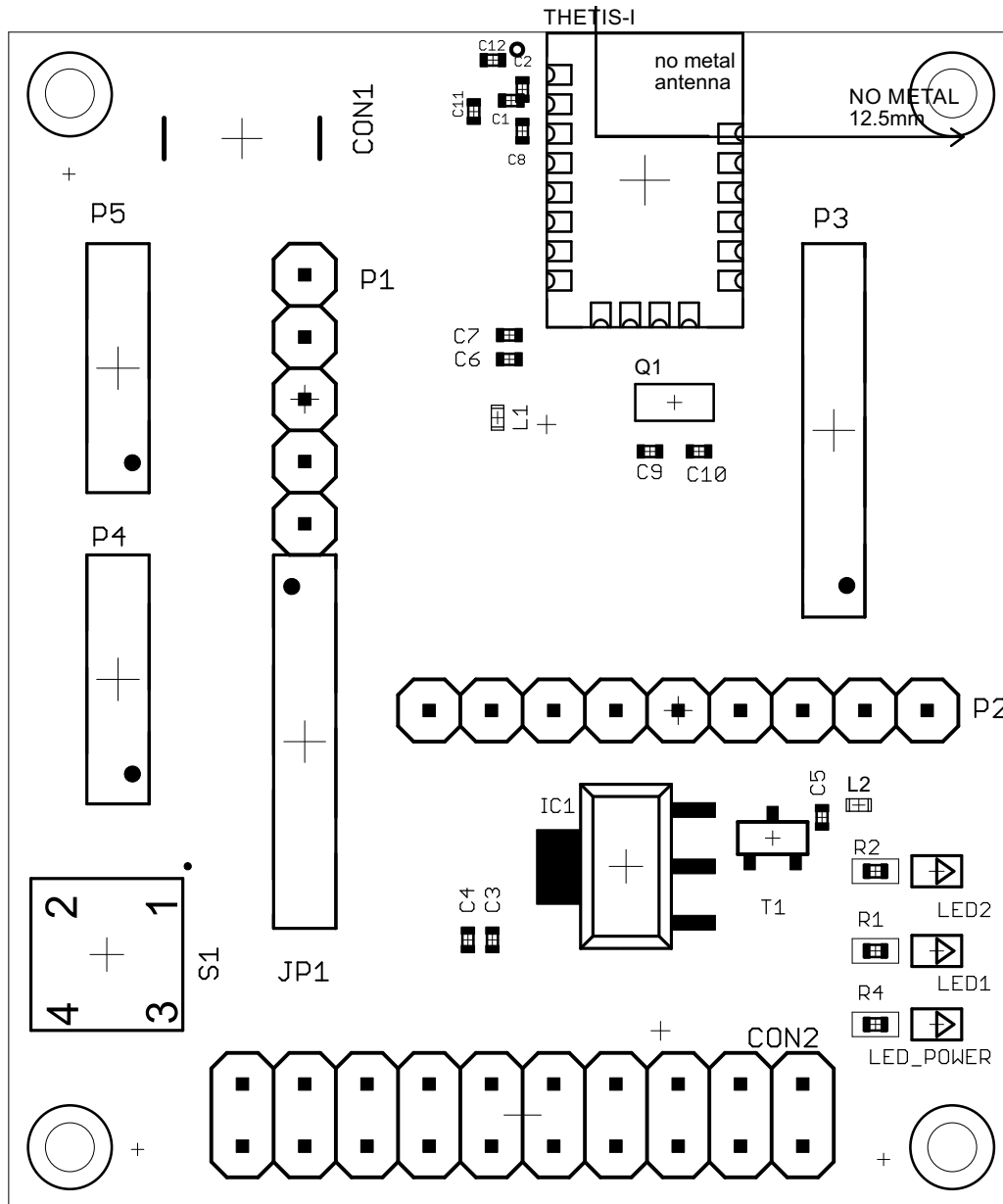

Figure 23: Assembly

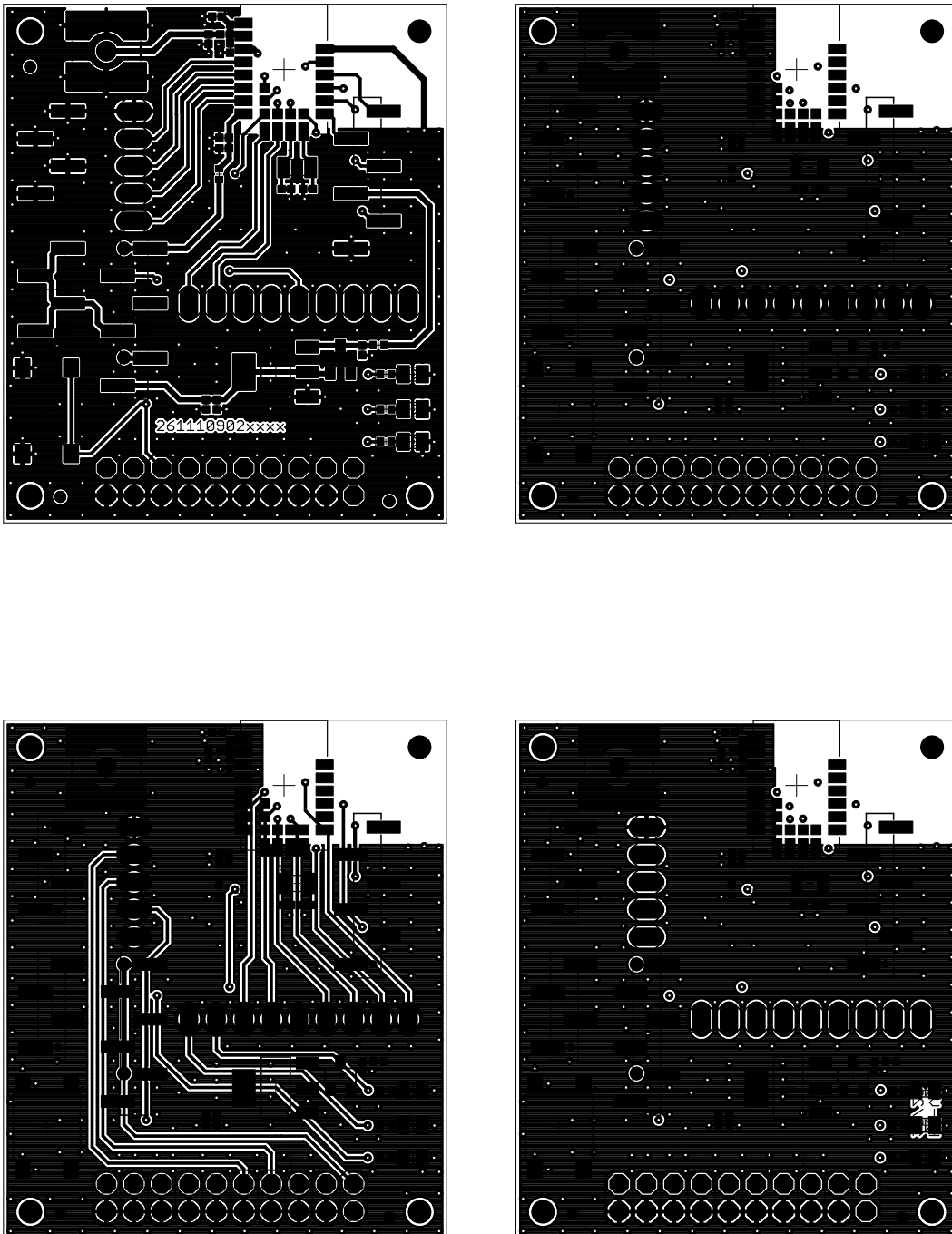

Figure 24: Top,bottom & internal layers



### 3.9 Bill of materials

Part	Value	PACK	MANUFACTURER	NR
C1	n.m.	0402		
C2	22pF	0.5mm	Würth Elektronik	885012005027
C3	1µF	0402	Würth Elektronik	885012105012
C4	100nF	0402	Würth Elektronik	885012205037
C5	100nF	0402	Würth Elektronik	885012205037
C6	1µF	0402	Würth Elektronik	885012105012
C7	100nF	0402	Würth Elektronik	885012205037
C8	n.m.	0402		
C9	12pF	0402		
C10	12pF	0402		
C11	n.m.	0402		
C12	n.m.	0402		
CON1	n.m.	SMD		
CON2	n.m.			
IC1	LDO, 3V			
JP1	61000618321	SMD	Würth Elektronik	61000618321
L1	7427927311	0402	Würth Elektronik	7427927311
L2	7427927311	0402	Würth Elektronik	7427927311
LED1	yellow	0805	Würth Elektronik	150080YS75000
LED2	blue	0805	Würth Elektronik	150080BS75000
LED POWER	red	0805	Würth Elektronik	150080RS75000
O1	OPT MARKE			
O2	OPT MARKE			
O3	OPT MARKE			
P1	n.m.			
P2	n.m.			
P3	61000618321	SMT	Würth Elektronik	61000618321
P4	61000418321	SMT	Würth Elektronik	61000418321
P5	61000418321	SMT	Würth Elektronik	61000418321
Q1	830009706	3.2 x 1.5mm S	Würth Elektronik	830009706
R1	1K5R			
R2	1K5R			
R4	10KR			
S1	430152043826		Würth Elektronik	430152043826
T1	n.m.			
THETIS-I	2611011021010	SMD	Würth Elektronik	2611011021010

## 4 Development board - Thetis-I USB radio stick

### 4.1 Block diagram

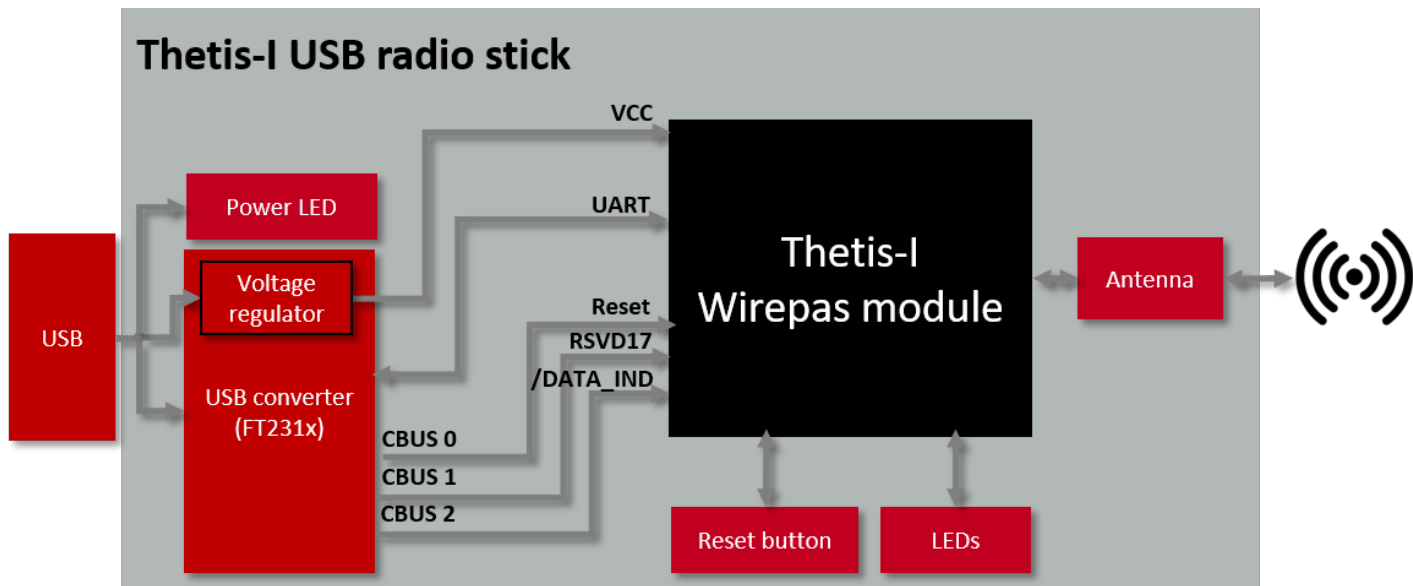

Figure 25: Block diagram

For further information about the Thetis-I USB radio stick, please refer to the dedicated user manual <https://we-online.com/Man/USB-Thetis-I>.

## 5 Development board - Thetis-I sensor node

### 5.1 Block diagram

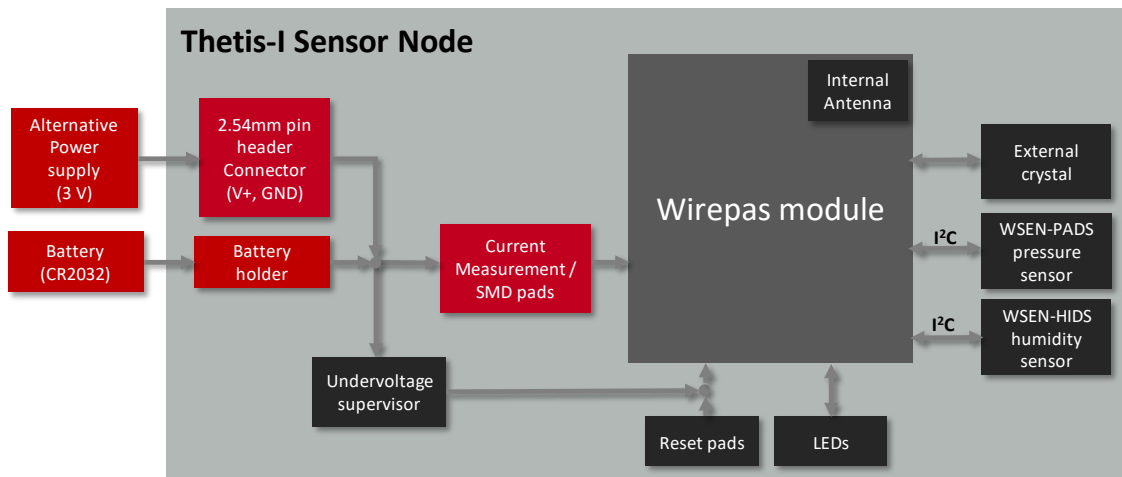

Figure 26: Block diagram

## 5.2 Connectors and pin headers

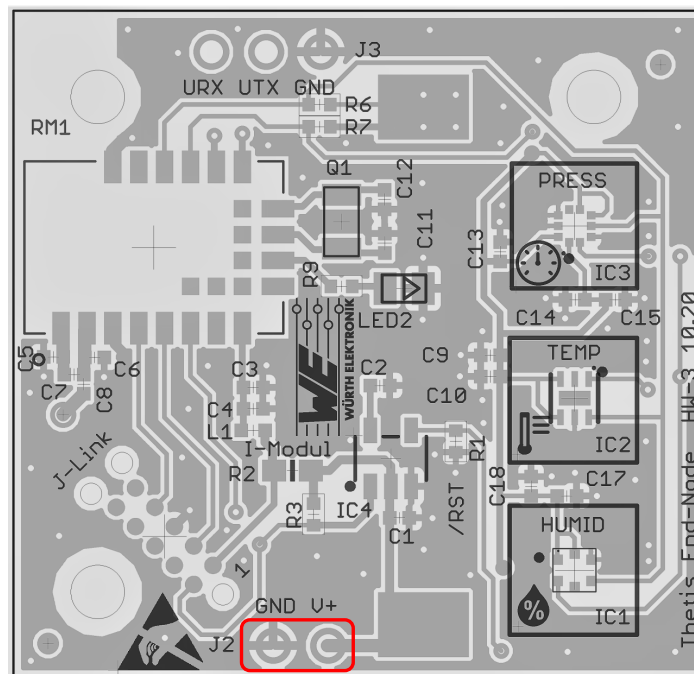

Figure 27: Connectors and pin headers

By default, no through hole components are mounted on the sensor node. However, there is a placeholder for the following pin header:

Pin header	Function	Pins	WE Article Number
J2	Power supply	1X2	61300211121

Table 16: Placeholder for 2.54mm pin header



Based on the necessity the required components shall be assembled.



Three holes with 2.5mm diameter are available for fastening, spacer or standoff connections



J3 & J-Link are reserved interfaces and not available to the user

### 5.2.1 J2: Alternative power supply connection

J2	Pin Name	Function
1	V+	External power supply (1.8 V to 3.6 V)
2	GND	Ground

Table 17: Pin header J2

### 5.3 Battery holder for CR2032 coin cell

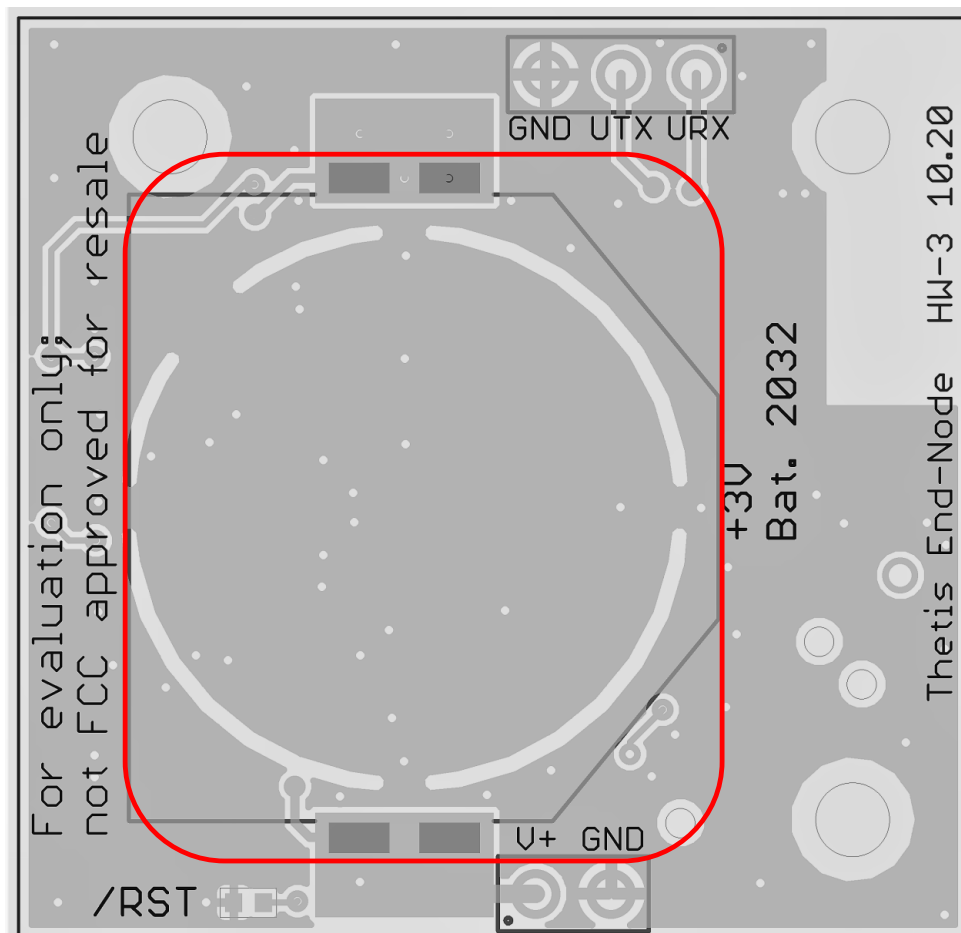

Figure 28: Battery holder for CR2032 coin cell

The sensor node is designed to be powered by a CR2032 coin cell.



Please mind the polarity connection labeled on the battery holder.

## 5.4 Reset button

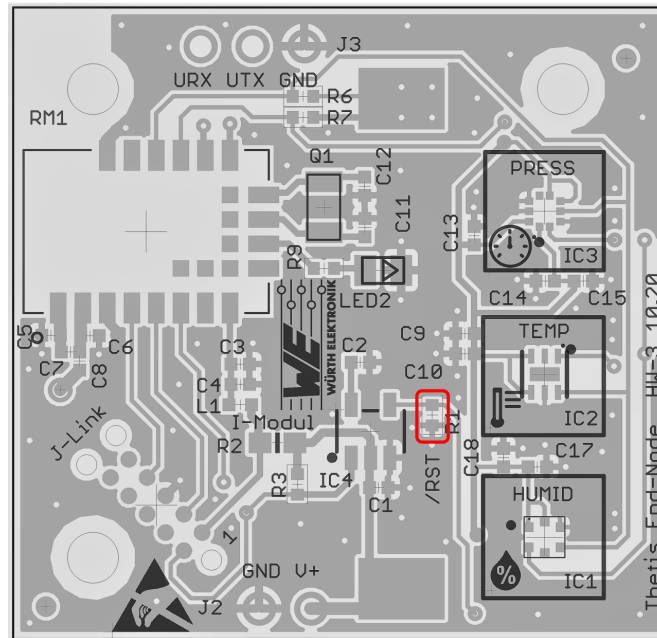

Figure 29: Reset pad on on the top layer

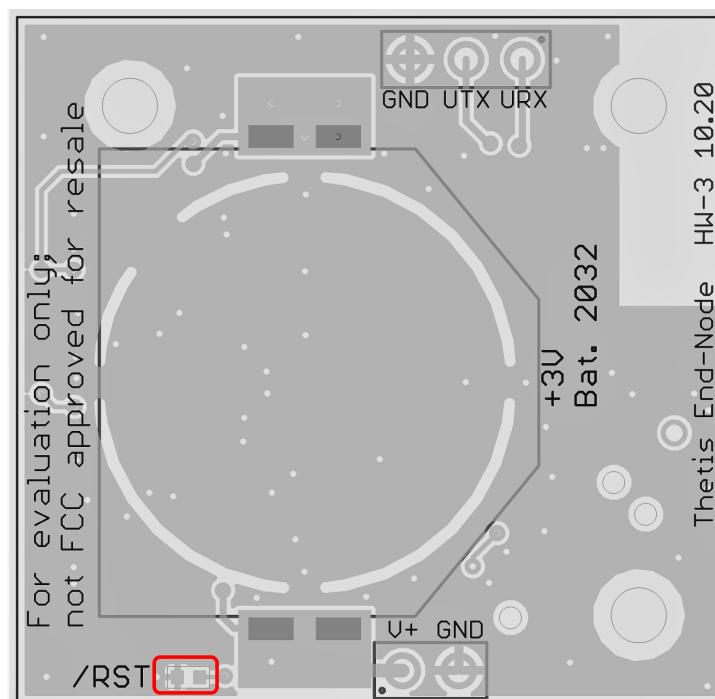

Figure 30: Reset pad on the bottom layer

On IC level, the active low reset input is configured with a pull-up resistor. The module provides a */RESET* pin that is connected to these SMD pads. To execute a module reset, either pads on top or bottom shall be short-circuited to GND.

## 5.5 Function blocks

### 5.5.1 Power supply

The sensor node board can be powered either by a CR2032 3 V lithium cell or via the pin header J2.



The duration of the battery depends on multiple factors, such as: manufacturer, operating temperature, distance of the sensor node to neighbour nodes, transmission interval and configuration of the Wirepas network.



The coin cell battery capacity is reduced by pulse drains. Pulse drains occur when transmitting or receiving data. In these intervals, the current consumption increases considerably compared to the sleep mode.



For measuring the current flowing into the module, resistor R2 shall be removed. The SMD pads can be then used for connecting an amperemeter

### 5.5.2 Undervoltage supervisor

The sensor node includes a voltage supervisor IC, to ensure proper voltage level at the power rail. When the battery's voltage decreases below +2.2 V, module's pin */RESET* is set low and the module is reset. The */RESET* pin is kept low until the undervoltage condition is overcome. This is  $V_+$  equals to +2.3 V.

### 5.5.3 LED

The LED built in the sensor node indicates the state of the module. If the sensor node does not find a route to the sink, the led blinks every 3 second. Once the connection with the mesh network is established, the led turns off.

State	LED2
No route to sink node found	On
Route to sink node found	Off

Table 18: LED behaviour

### 5.5.4 Low frequency crystal

To meet the hardware requirements of the Wirepas mesh firmware, the crystal oscillator network is designed as described in section 3.6.4. After fine-tuning, the load capacitors C11 and C12 are chosen 15 pF each.

## 5.5.5 Sensor

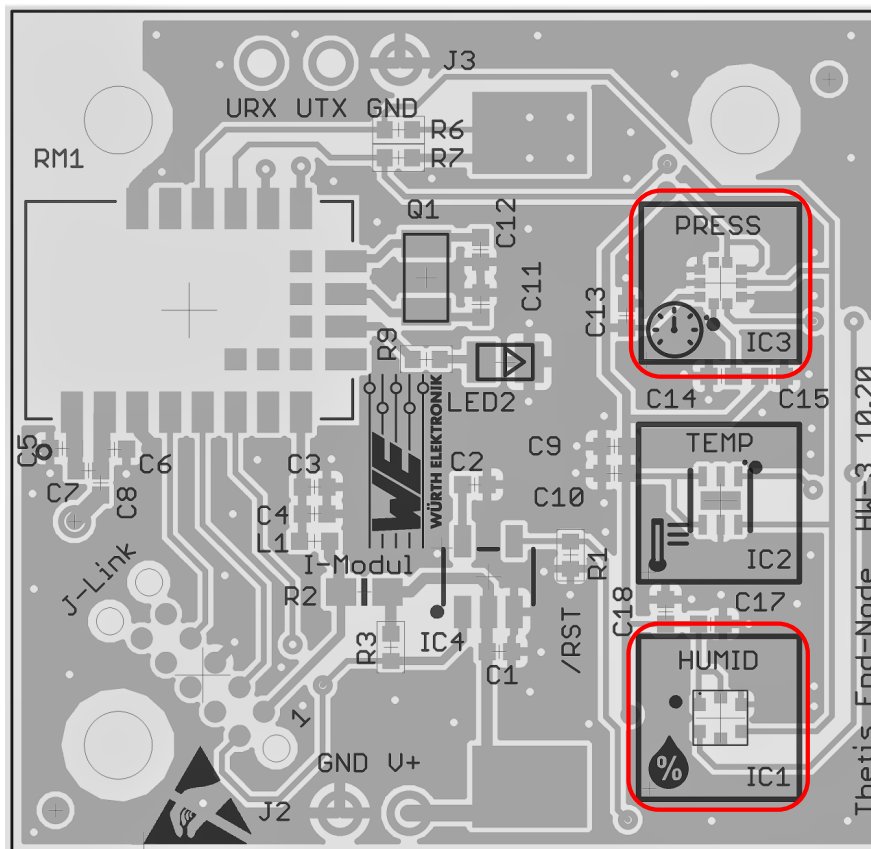

Figure 31: Assembled sensors

By default the following sensors are assembled on the board:

Designator	Function	Name	WE article number
IC1	Humidity sensor with integrated Temperature sensor	WSEN-HIDS	2525020210001
IC3	Absolute pressure sensor	WSEN-PADS	2511020213301

Table 19: Sensors assembled on the sensor node board

Additionally, there are placeholders for WSEN-TIDS and its respective bypass capacitors. The table below lists the optional components.

Placeholder	Function	WE article number
IC2	Temperature Sensor	2521020222501
C9	100 nF Bypass capacitor	885012205018
C10	2.2 $\mu$ F Bypass capacitor	885012208015

Table 20: Sensors assembled on the sensor node board



## 5.6 Functional description

As described above, the sensor node contains a Wirepas radio module and several Würth Elektronik eiSos sensors. Its function is to repeatedly read the respective sensor values via I<sup>2</sup>C and send them via Wirepas mesh network to a sink device.

After boot-up, the sensor node searches for a Wirepas network with the following settings:

- Network address 7
- Network channel 39
- No encryption and authentication

As long as the sensor node searches for the network, its LED blinks.



If a non-default password is applied or the network ID is changed, it must be ensured that such information is not lost. A factory reset or recovery is not available on the sensor nodes with current hardware version HW-V3.

As soon as the network is found, the LED goes off, the sensor node connects to it and sends a start message. Afterwards, the acquired sensor data are sent repeatedly to the sink. These incoming messages also include the address of the transmitting node. In the Wirepas Commander, this address can be copy-pasted to send data or change settings of a single node of the network.

The default interval is 60 s and the default node role is router node with automatic role selection. That means that every sensor node:

- is capable of routing traffic for other nodes in time slotted mode
- evaluates its role to ensure that there are not too many routing nodes within the radio range

### 5.6.1 Configuration of the update interval and data format

The update interval and data format of the sensor node are application settings that can be modified by sending a standard data message to the corresponding end points.

Here we use either the sink (Thetis-I USB radio stick) or any other Thetis-I module to send the respective command to the sensor node for the modification of the interval. To do so, just send the new interval value in seconds as ASCII string to the endpoint 104 of the sensor node (see figure 32). The sensor node address must be specified in the dedicated field.

#### Sensor node end points

**104 - RECEPTION\_EP\_SET\_PERIOD:** This end point of the sensor node is used to configure the sensor update interval.

**105 - RECEPTION\_EP\_SET\_FORMAT:** This end point of the sensor node is used to configure the format of the sensor data.

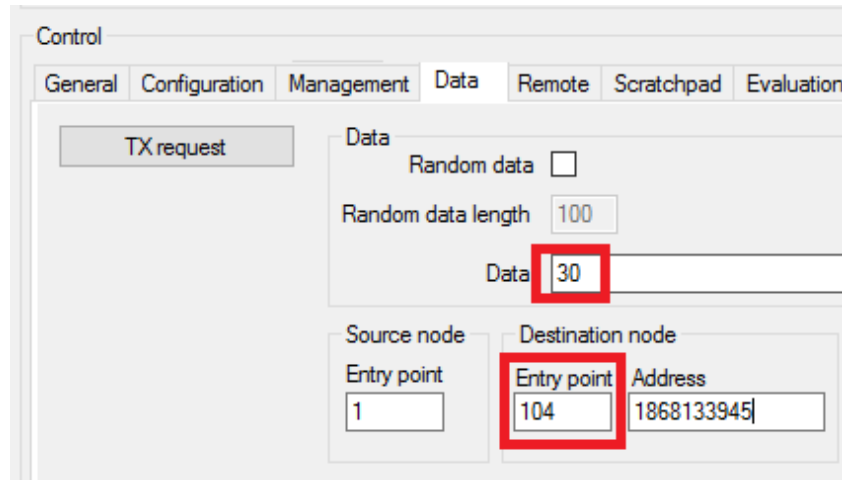

Figure 32: Example: Set the period to 30s

The other end point 105 can be used to set the format of the sensor data in the Wirepas radio packet. To change it, just send one of the following numbers as ASCII string to the end point 105 (see figure 33):

### Sensor node data formats

- 0 - DATA\_FORMAT\_FULL\_ASCII\_STRING** (Default) All data is sent as ASCII string to the sink end point 106.
- 1 - DATA\_FORMAT\_FULL\_RAW** All data is sent in raw format to sink end point 107. This allows an energy efficient transmission of sensor data.
- 2 - DATA\_FORMAT\_INTEGER\_ON\_DIFFERENT\_EP** All data is sent in ASCII format to sink end point 108, 109 and 110 respectively. Attention: In this case, three Wirepas messages are sent per interval. This results in an increased power consumption.

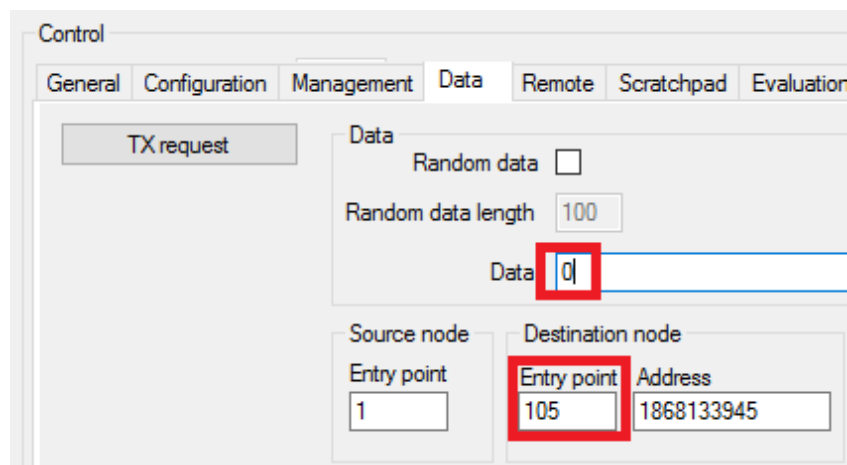

Figure 33: Example: Set format to DATA\_FORMAT\_FULL\_ASCII\_STRING

As described, depending on the configured format the Wirepas data packets are sent to different end points of the sink:

## Sink end points

**106 - TRANSMISSION\_EP\_ASCII\_STRING:** This end point of the sink is used for all ascii coded messages, e.g. the startup-message.

**107 - TRANSMISSION\_EP\_RAW:** This end point of the sink is used for all sensor data in raw format.

HIDS ID	Humidity [0.01%]	Temp. [0.01 °C]	PADS ID	Pressure [Pa]	Temp. [0.01 °C]
0x01	16bit	16bit	0x02	16bit	16bit

**108 - TRANSMISSION\_EP\_INTEGER\_HIDS:** This end point of the sink is used only for the HIDS sensor data in ASCII format.

**109 - TRANSMISSION\_EP\_INTEGER\_TIDS:** This end point of the sink is used only for the HIDS sensor data in ASCII format.

**110 - TRANSMISSION\_EP\_INTEGER\_PADS:** This end point of the sink is used only for the HIDS sensor data in ASCII format.

### 5.6.2 Configuration of Wirepas node settings, like node role

Wirepas stack settings of a Wirepas node, such as node role or node id, can be configured by remote configuration messages in a predefined sequence:

- Sending a "Begin" request;
- The node acknowledges the "Begin" request with a "Response" message;
- Sending a "Write" request for the change of setting;
- The node acknowledges the "Write" request with a "Response" message;
- Placing an "End" request to deploy the new settings;
- The node acknowledges of the "End" request with a "Response" message;
- Sending an "Update" request;
- The node acknowledges the "Update" request with a "Response" message;

See the Wirepas Mesh Remote API Reference Manual [2] for detailed information.

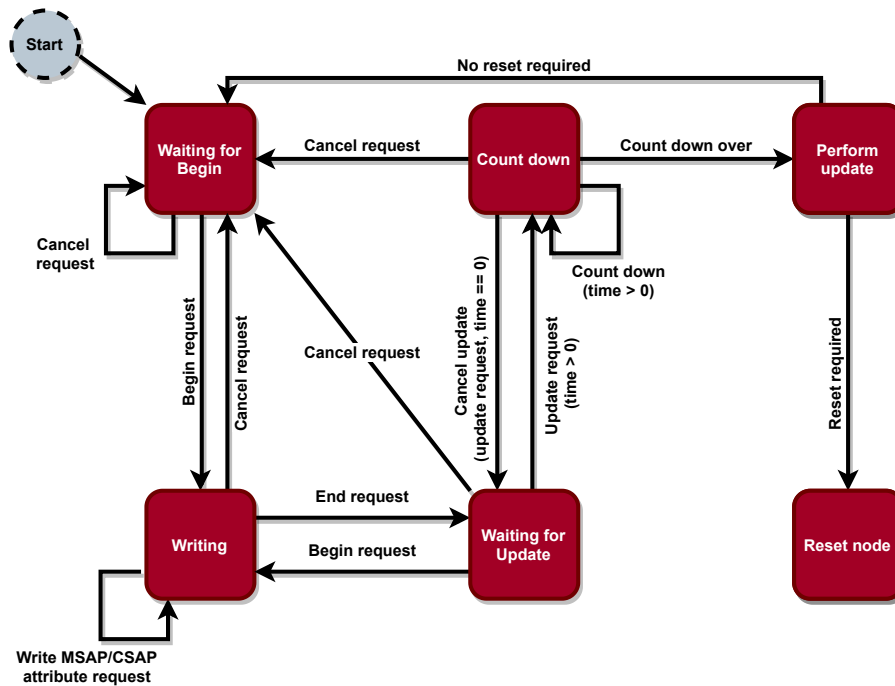

Figure 34: Flow chart: Remote writing CSAP and MSAP attributes

The Wirepas Commander provides the so called "Remote" tab with the remote commands, allowing to change configuration settings of the connected nodes. The "Begin", "Write", "End" and "Update" requests can be sent with the corresponding buttons, once the related response messages appear in the status window. The node address must be specified in the dedicated field.

In the example below, the node role of a sensor node is set to "Low Energy Router node": the CSAP attribute NodeRole must be set to 0x02.

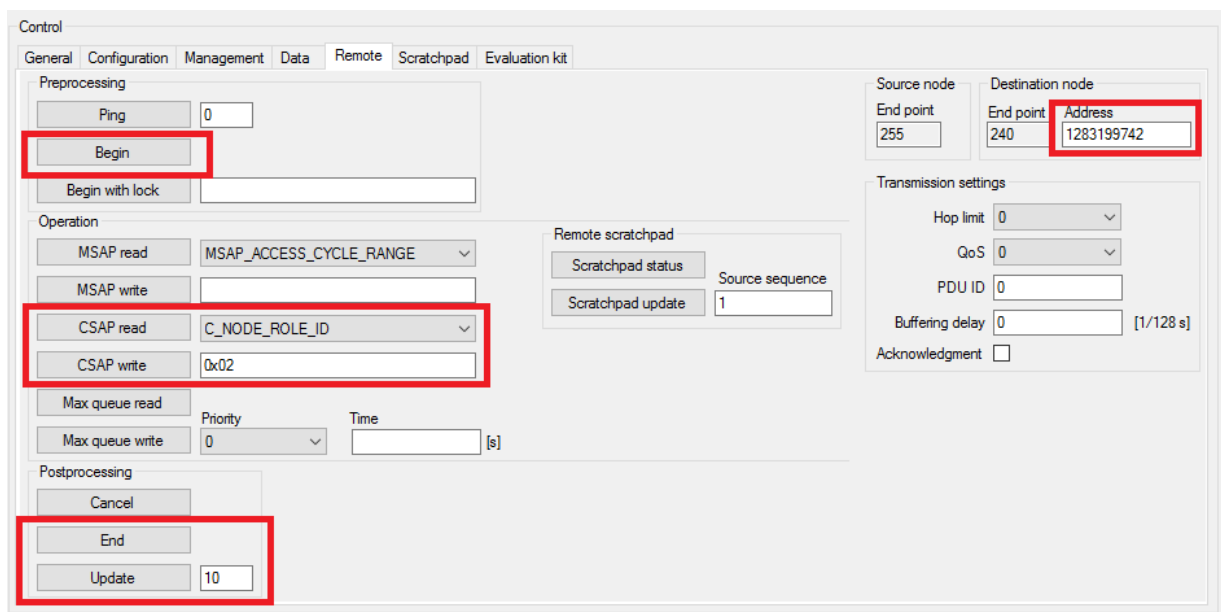

Figure 35: Example: Set the node role to "Low Energy Router node" - remote command configuration

```

[19-02-03.894] SUCCESS: Remote begin requested
[19-02-12.184] SUCCESS: (DSAP_DATA_TX_INDICATION) Remote message sent to destination (926833757,240) with PDU ID 0
[19-02-20.352] Remote command received from address 926833757: Number of hops 1 / Travel time 9,6953125s
[19-02-20.352] BEGIN_RESPONSE
[19-02-25.394] SUCCESS: Remote CSAP write requested
[19-02-28.465] SUCCESS: (DSAP_DATA_TX_INDICATION) Remote message sent to destination (926833757,240) with PDU ID 0
[19-02-34.656] Remote command received from address 926833757: Number of hops 1 / Travel time 7,9765625s
[19-02-34.656] CSAP_WRITE_ATTRIBUTE_RESPONSE Attribute ID C_NODE_ROLE_ID Value 2 (0x02)
[19-02-40.849] SUCCESS: Remote end requested
[19-02-42.800] SUCCESS: (DSAP_DATA_TX_INDICATION) Remote message sent to destination (926833757,240) with PDU ID 0
[19-02-50.964] Remote command received from address 926833757: Number of hops 1 / Travel time 8,296875s
[19-02-50.965] END_RESPONSE
[19-02-52.807] SUCCESS: Remote update requested
[19-02-59.076] SUCCESS: (DSAP_DATA_TX_INDICATION) Remote message sent to destination (926833757,240) with PDU ID 0
[19-03-07.219] Remote command received from address 926833757: Number of hops 1 / Travel time 8,5546875s
[19-03-07.219] UPDATE_RESPONSE Time 16

```

Figure 36: Example: Set the node role to "Low Energy Router node" - Status Window

### 5.6.3 Reading a Wirepas node setting

Wirepas stack settings of a Wirepas node can be read by sending a "Read" request. The node acknowledges the "Read" request with a "Response" message delivering the requested information. In the Wirepas Commander, this can be done using the "Read" button available in the "Remote" tab.

In the example below, the configured network address is requested to the sensor node, which responds with the default address "7".

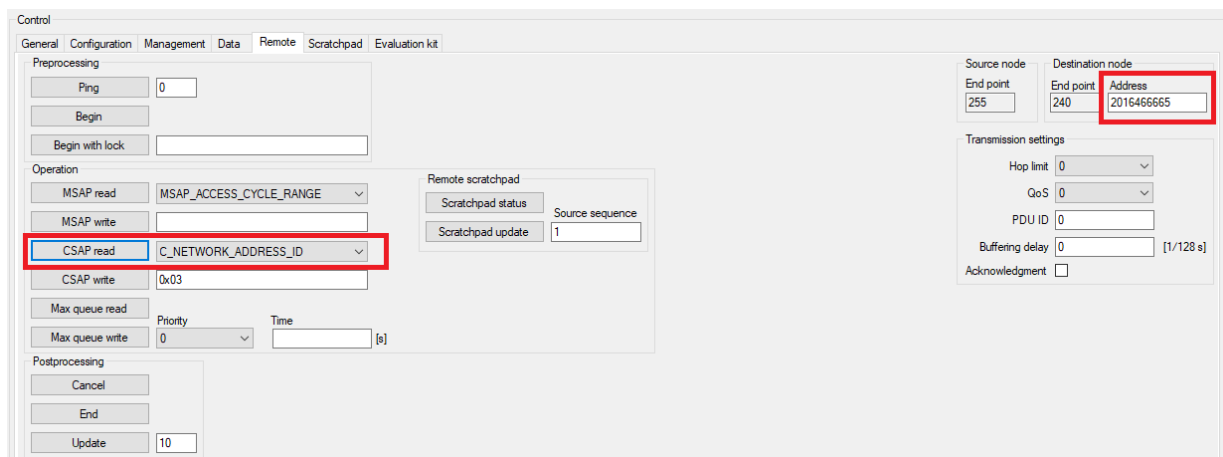

Figure 37: Example: Read network address - remote command configuration

```

[09-56-55.826] SUCCESS: Remote CSAP read requested
[09-56-57.509] SUCCESS: (DSAP_DATA_TX_INDICATION) Remote message sent to destination (2016466665,240) with PDU ID 0
[09-57-05.653] Remote command received from address 2016466665: Number of hops 1 / Travel time 9,421875s
[09-57-05.669] CSAP_READ_ATTRIBUTE_RESPONSE Attribute ID C_NETWORK_ADDRESS_ID Value 7 (0x000007)

```

Figure 38: Example: Read network address - Status Window

# 5.7 Schematic

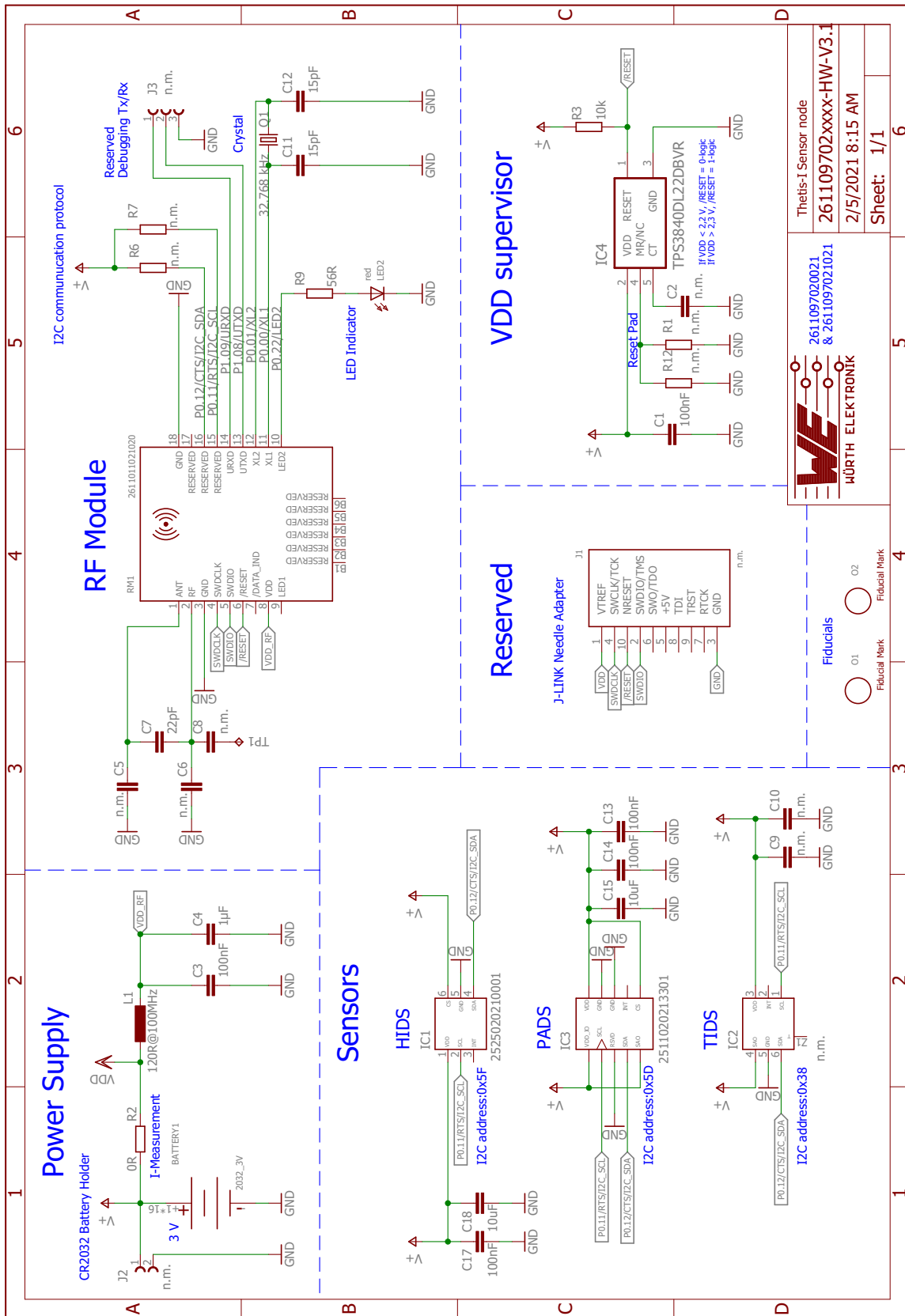

Figure 39: Schematic sheet

## 5.8 Layout

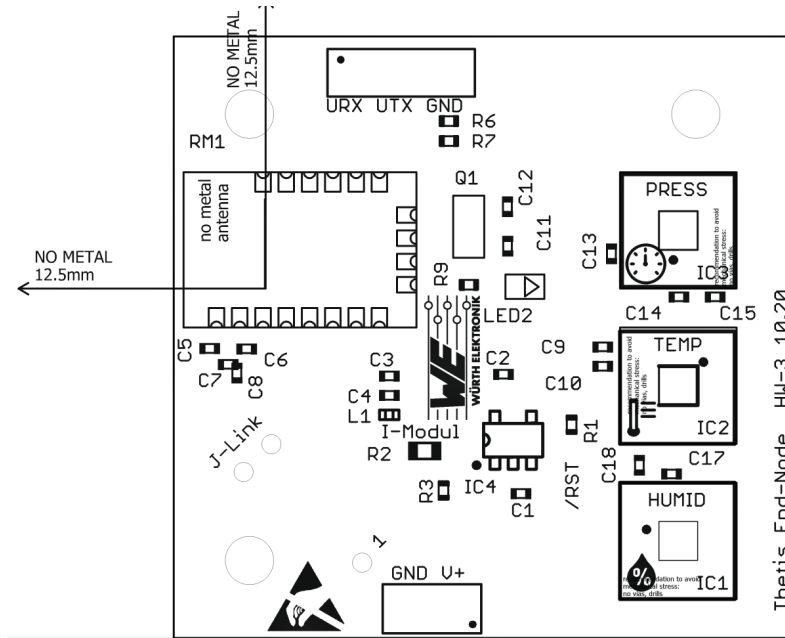

Figure 40: Assembly on top layer

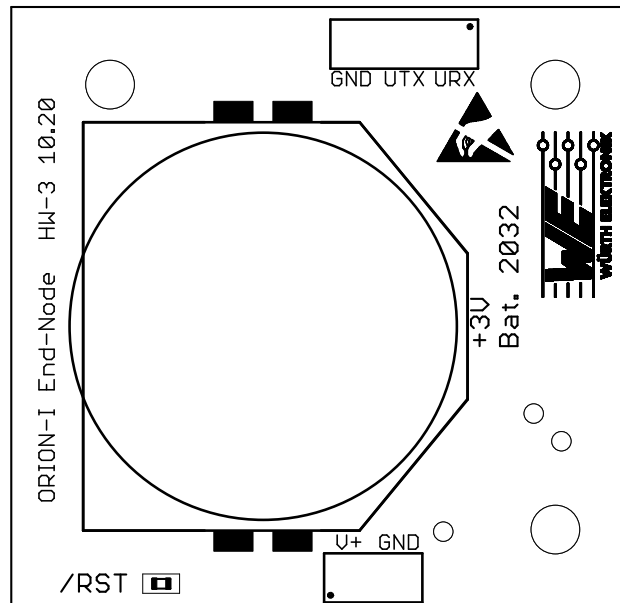

Figure 41: Assembly on bottom layer

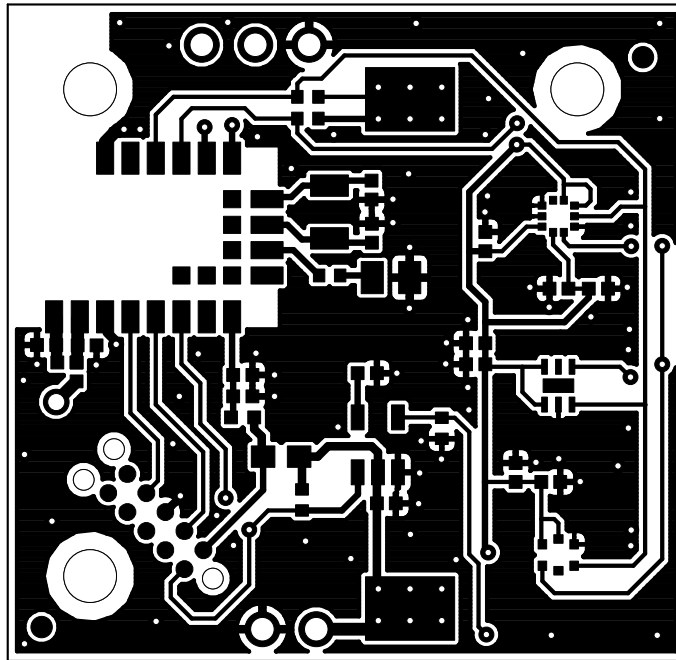

Figure 42: Layout top layer

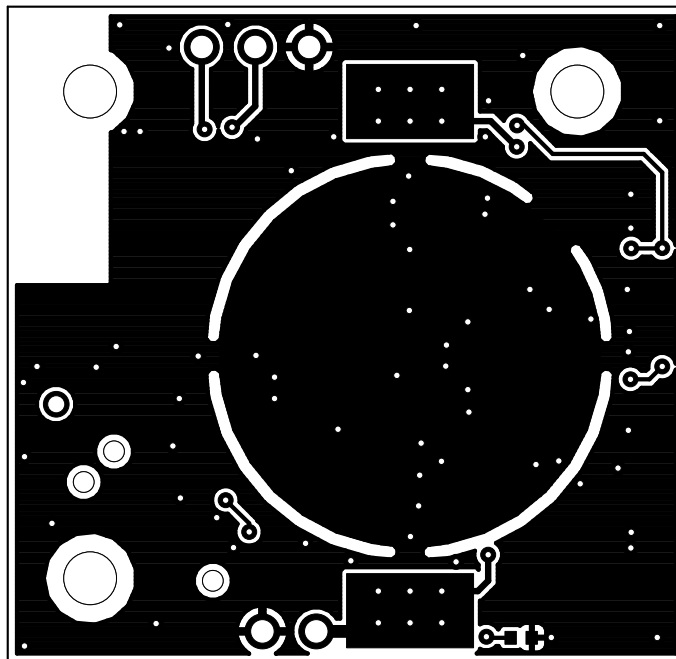

Figure 43: Layout bottom layer



## 5.9 Optional enclosure mounting

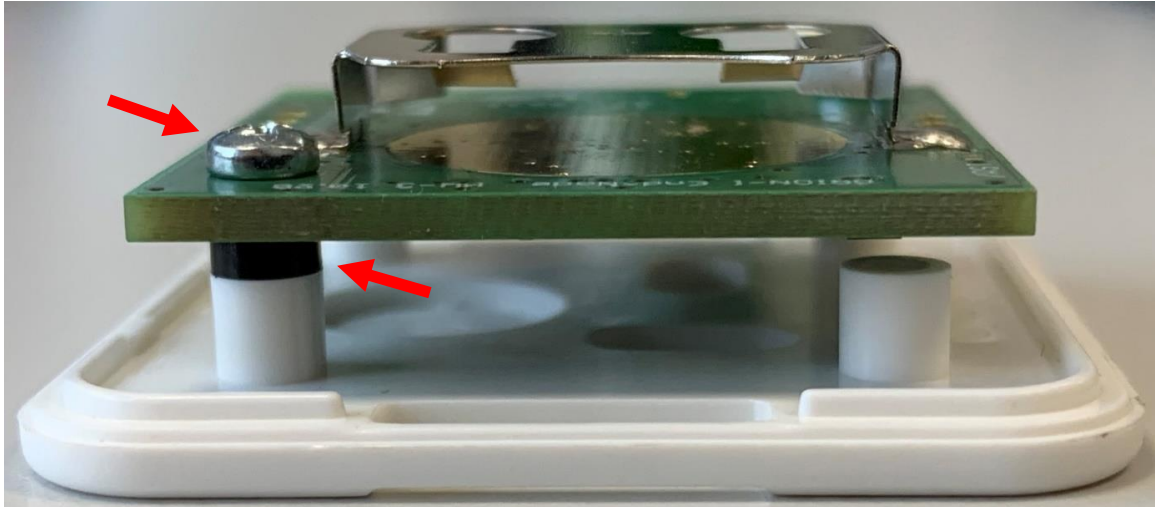

Figure 44: Optional enclosure mounting

Optionally, the sensor node can be mounted in *1551V1WH* enclosure. The table below lists all necessary component for properly fastening the PCB on the enclosure.

Article	Manufacturer	Article number
ABS Plastic Miniature Enclosures	Hammond Manufacturing	<i>1551V1WH</i>
Plastic spacers	Würth Elektronik	<i>960020010</i>
2mmX6.5mm Self-tapping screw	Würth GmbH	<i>5051022065</i>

Table 21: article list



Plastic spacers between the PCB and the standoffs are needed to avoid collision of components with the enclosure's basement, as shown in the figure above.

## 5.10 Bill of materials

Part	Value	Package	MANUFACTURER	NR
BATTERY1	2032_3V	BATTERY_LIR2032_RND_PAD	Keystone	3034
C1	100nF	C0402_IPC	Würth Elektronik	885012205037
C2	n.m.	C0402_IPC	N/A	n.m.
C3	100nF	C0402_IPC	Würth Elektronik	885012205037
C4	22µF	C0402_IPC	Yageo	CC0402MRX5R5BB226
C5	n.m.	C0402_IPC	N/A	n.m.
C6	n.m.	C0402_IPC	N/A	n.m.
C7	22pF	C0402_IPC	Würth Elektronik	885012005057
C8	n.m.	C0402_IPC	N/A	n.m.
C9	n.m.	C0402_IPC	N/A	n.m.
C10	n.m.	C0402_IPC	N/A	n.m.
C11	15pF	C0402_IPC	Samsung	CL05C150JB5NNNC
C12	15pF	C0402_IPC	Samsung	CL05C150JB5NNNC
C13	100nF	C0402_IPC	Würth Elektronik	885012205037
C14	100nF	C0402_IPC	Würth Elektronik	885012205037
C15	10uF	C0402_IPC	Murata	GRM155R60J106ME15J
C17	100nF	C0402_IPC	Würth Elektronik	885012205037
C18	10uF	C0402_IPC	Murata	GRM155R60J106ME15J
IC1	2525020210001	WSEN-HIDS_2525020210001	Würth Elektronik	2525020210001
IC2	n.m.	WSEN-TIDS_2521020222501	N/A	n.m.
IC3	2511020213301	WSEN-PADS_2511020213301	Würth Elektronik	2511020213301
J1	n.m.	J-LINK_NEEDLE_ADAPTER	N/A	n.m.
J2	n.m.	N/A	N/A	n.m.
J3	n.m.	N/A	N/A	n.m.
L1	120R@100MHz	L0402_WE-MK	Würth Elektronik	7427927311
LED2	red	0805	Würth Elektronik	150080RS75000
O1	OPT_MARKE	OPTISCHE_MARKE	N/A	N/A
O2	OPT_MARKE	OPTISCHE_MARKE	N/A	N/A
Q1	32.768 kHz	3216	Würth Elektronik	830009706
R1	n.m.	R0402_IPC	N/A	n.m.
R2	0R	R0603_IPC	Yageo	RC0603JR-070RL
R3	10k	R0402_IPC	Yageo	RC0402FR-0710KL
R6	n.m.	R0402_IPC	N/A	n.m.
R7	n.m.	R0402_IPC	N/A	n.m.
R9	56R	R0402_IPC	Yageo	RC0402FR-0756KL
R12	n.m.	R0402_IPC	n.m.	n.m.
RM1	2611011021020	WIRL-PRO2_2611011021020	Würth Elektronik	2611011021020
TP1	n.m.	D0.8MM_AUTO	N/A	n.m.
IC4	TPS3840DL22DB	SOIC_LXDBVR_TEX-M	TI	TPS3840DL22DBVR

## 6 Würth Elektronik eiSos test network

In the setup of a Wirepas network, many topologies and configuration options are possible. In this chapter, we describe our test network in its main parameters, as well as the main observations that could be made.

The test network runs 24/7 and consists of 45 nodes (sensor nodes and Thetis-I nodes, similar to the ones included in the evaluation kit) and one sink device. They are distributed over a large office facility on two floors. Sensor data are transmitted from the sensor nodes to the sink, where the PC tool Wirepas commander is running and reporting the transmitted data. The setup of the network is described in Table 22 and Figure 45.

Parameter	Value
Total number of network nodes	46
Number of mains powered Thetis-I mini EV-boards (sink device)	1
Number of mains powered Thetis-I USB radio sticks (routing nodes)	5
Number of battery-powered sensor nodes (routing nodes)	13
Number of battery-powered sensor nodes (non-routing nodes)	27
Number of walls between two nodes	0 - 3
Mean distance between two nodes	7 - 15 meters
Diagnostic messages	Active
Diagnostic data update interval	60 seconds
Sensor data update interval	10 seconds
Mode (for all nodes)	Low Energy Mode
Radio interferers:	5 WiFi routers and production line including 2.4 GHz verification environment
Transmission load (size of payload data)	19 bytes
Access cycle (radio synchronization interval)	8 seconds
Wirepas stack version	5.0.2.0

Table 22: Würth Elektronik eiSos test network: key parameters

The network performance is the result of numerous elements that need to be evaluated in the specific use case. Nevertheless, we would like to describe some of the main design practices and factors to consider when setting up a battery-powered network, in order to maximize overall network's performance and battery life of the sensor nodes.

- One of the main factors affecting power consumption, and thus the battery life of the nodes, is the transmission of the data from the node itself: at every synchronization interval (access cycle) data will be sent, in case there is data available. Thus the amount and availability of data plays an important role.

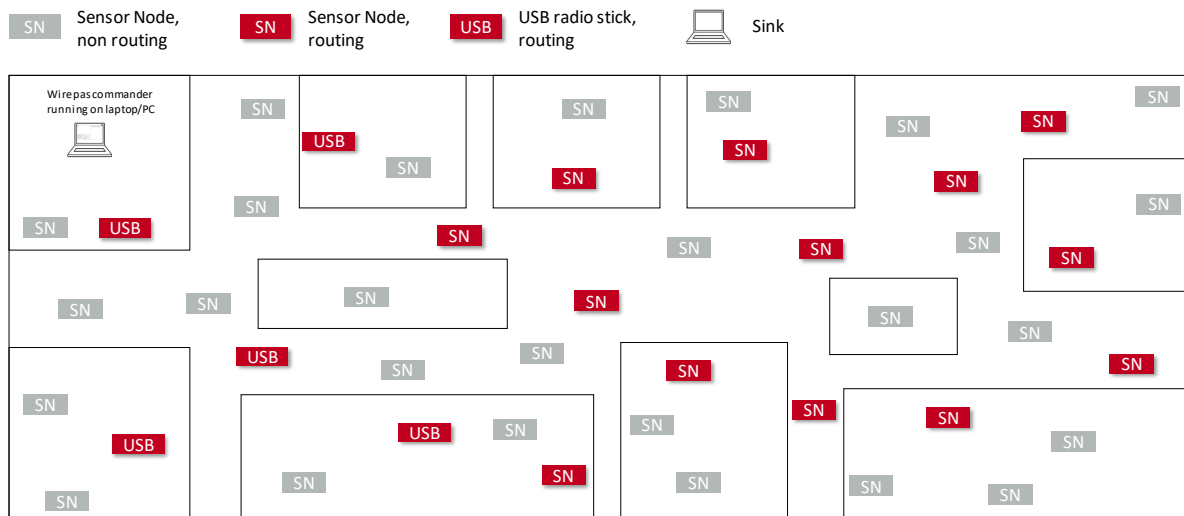

Figure 45: Würth Elektronik eiSos test network topology

- Every node chooses the best path to the sink automatically, and with that, to which neighbour node to send the data. More output power is required to reach distant nodes, or nodes on the other side of walls or obstacles.
- Changes in the network topology cause the nodes to perform a new scan of the environment in order to update the above mentioned connections to the neighbour nodes. This process has a high cost in terms of energy consumption.
- Since the sink device is the destination node of the data coming from all other nodes of the network (payload and diagnostic data), traffic on the routing nodes in proximity of the sink is normally higher. Therefore, it is good practice, if possible, to place mains powered routing nodes in proximity of the sink.
- Power consumption on the Wirepas network nodes is not constant. It is based on the alternance of sleeping times and pulse drains. Pulse drains occur when transmitting or receiving data. Battery discharge characteristics and lifetime have to be evaluated in connection with this specific behaviour.



In coin cell batteries, pulse drains reduce battery capacity.

- At the end of a battery lifetime, whenever the remaining battery capacity is too low for the occurring current peak, a voltage drop occurs, causing the module to perform a reset. Once the device is connected again to the network, it tries to send data again and a new reset will occur. That means that the module might enter a loop of voltage drops and resets, causing the battery to discharge very fast.

The Würth Elektronik eiSos Wirepas test network was built up on December 1, 2020. The below table represents the status on February 16, 2021.

Parameter	Value
Message delay (node to sink)	< 1 sec (1 node), 1-10 sec (25 nodes), 10-100 sec (20 nodes), >100 sec (0 nodes)
RSSI value	<-80 dBm (2 nodes), -80 to 75 dBm (7 nodes), >-75 dBm (36 nodes)
Buffer usage (nodes)	< 2 % for all nodes
Buffer usage (sink)	< 4 %

Table 23: Würth Elektronik eiSos test network: Status

## 7 References

- [1] Wirepas. Wirepas Mesh Dual-MCU API Reference Manual, WP-RM-100, version 5.1A. <https://www.we-online.com/Man/WIREPAS-I>.
- [2] Wirepas. Wirepas Mesh Remote API Reference Manual, WP-RM-117, version 5.0A. <https://www.we-online.com/Man/WIREPAS-II>.
- [3] Würth Elektronik. Thetis-I USB Radio Stick user manual. <https://we-online.com/Man/USB-Thetis-I>.
- [4] Würth Elektronik. Thetis-I user manual. <https://www.we-online.com/Man/THETIS-I>.
- [5] Würth Elektronik. Wirepas Commander PC tool. <https://www.we-online.com/Wirepas-Commander>.

## 8 Regulatory compliance information

### 8.1 European Conformity

Pursuant to Article 1 (2.) of the EU directive 2014/53/EU, Article 1 (2.) the directive does not apply to equipment listed in Annex I (4.): custom-built evaluation kits designed for professionals to be used solely at research and development facilities for such purposes.

### 8.2 FCC

Pursuant to §2.803 (c) of Title 47 Chapter I Subchapter A Part 2 Subpart I, the evaluation kit falls under the FCC exception. Therefore it is marked as "For evaluation only; not FCC approved for resale".

### 8.3 Exemption clause

Relevant regulation requirements are subject to change. Würth Elektronik eiSos does not guarantee the accuracy of the before mentioned information. Directives, technical standards, procedural descriptions and the like may be interpreted differently by the national authorities. Equally, the national laws and restrictions may vary with the country. In case of doubt or uncertainty, we recommend that you consult with the authorities or official certification organizations of the relevant countries. Würth Elektronik eiSos is exempt from any responsibilities or liabilities related to regulatory compliance.

Notwithstanding the above, Würth Elektronik eiSos makes no representations and warranties of any kind related to their accuracy, correctness, completeness and/or usability for customer applications. No responsibility is assumed for inaccuracies or incompleteness.

## 9 Important notes

The following conditions apply to all goods within the wireless connectivity product range of Würth Elektronik eiSos GmbH & Co. KG:

### 9.1 General customer responsibility

Some goods within the product range of Würth Elektronik eiSos GmbH & Co. KG contain statements regarding general suitability for certain application areas. These statements about suitability are based on our knowledge and experience of typical requirements concerning the areas, serve as general guidance and cannot be estimated as binding statements about the suitability for a customer application. The responsibility for the applicability and use in a particular customer design is always solely within the authority of the customer. Due to this fact, it is up to the customer to evaluate, where appropriate to investigate and to decide whether the device with the specific product characteristics described in the product specification is valid and suitable for the respective customer application or not. Accordingly, the customer is cautioned to verify that the documentation is current before placing orders.

### 9.2 Customer responsibility related to specific, in particular safety-relevant applications

It has to be clearly pointed out that the possibility of a malfunction of electronic components or failure before the end of the usual lifetime cannot be completely eliminated in the current state of the art, even if the products are operated within the range of the specifications. The same statement is valid for all software sourcecode and firmware parts contained in or used with or for products in the wireless connectivity and sensor product range of Würth Elektronik eiSos GmbH & Co. KG. In certain customer applications requiring a high level of safety and especially in customer applications in which the malfunction or failure of an electronic component could endanger human life or health, it must be ensured by most advanced technological aid of suitable design of the customer application that no injury or damage is caused to third parties in the event of malfunction or failure of an electronic component.

### 9.3 Best care and attention

Any product-specific data sheets, manuals, application notes, PCN's, warnings and cautions must be strictly observed in the most recent versions and matching to the products firmware revisions. This documents can be downloaded from the product specific sections on the wireless connectivity homepage.

### 9.4 Customer support for product specifications

Some products within the product range may contain substances, which are subject to restrictions in certain jurisdictions in order to serve specific technical requirements. Necessary information is available on request. In this case, the field sales engineer or the internal sales person in charge should be contacted who will be happy to support in this matter.



## 9.5 Product improvements

Due to constant product improvement, product specifications may change from time to time. As a standard reporting procedure of the Product Change Notification (PCN) according to the JEDEC-Standard, we inform about major changes. In case of further queries regarding the PCN, the field sales engineer, the internal sales person or the technical support team in charge should be contacted. The basic responsibility of the customer as per section 9.1 and 9.2 remains unaffected. All wireless connectivity module driver software "wireless connectivity SDK" and its source codes as well as all PC software tools are not subject to the Product Change Notification information process.

## 9.6 Product life cycle

Due to technical progress and economical evaluation we also reserve the right to discontinue production and delivery of products. As a standard reporting procedure of the Product Termination Notification (PTN) according to the JEDEC-Standard we will inform at an early stage about inevitable product discontinuance. According to this, we cannot ensure that all products within our product range will always be available. Therefore, it needs to be verified with the field sales engineer or the internal sales person in charge about the current product availability expectancy before or when the product for application design-in disposal is considered. The approach named above does not apply in the case of individual agreements deviating from the foregoing for customer-specific products.

## 9.7 Property rights

All the rights for contractual products produced by Würth Elektronik eiSos GmbH & Co. KG on the basis of ideas, development contracts as well as models or templates that are subject to copyright, patent or commercial protection supplied to the customer will remain with Würth Elektronik eiSos GmbH & Co. KG. Würth Elektronik eiSos GmbH & Co. KG does not warrant or represent that any license, either expressed or implied, is granted under any patent right, copyright, mask work right, or other intellectual property right relating to any combination, application, or process in which Würth Elektronik eiSos GmbH & Co. KG components or services are used.

## 9.8 General terms and conditions

Unless otherwise agreed in individual contracts, all orders are subject to the current version of the "General Terms and Conditions of Würth Elektronik eiSos Group", last version available at [www.we-online.com](http://www.we-online.com).

## 10 Legal notice

### 10.1 Exclusion of liability

Würth Elektronik eiSos GmbH & Co. KG considers the information in this document to be correct at the time of publication. However, Würth Elektronik eiSos GmbH & Co. KG reserves the right to modify the information such as technical specifications or functions of its products or discontinue the production of these products or the support of one of these products without any written announcement or notification to customers. The customer must make sure that the information used corresponds to the latest published information. Würth Elektronik eiSos GmbH & Co. KG does not assume any liability for the use of its products. Würth Elektronik eiSos GmbH & Co. KG does not grant licenses for its patent rights or for any other of its intellectual property rights or third-party rights.

Notwithstanding anything above, Würth Elektronik eiSos GmbH & Co. KG makes no representations and/or warranties of any kind for the provided information related to their accuracy, correctness, completeness, usage of the products and/or usability for customer applications. Information published by Würth Elektronik eiSos GmbH & Co. KG regarding third-party products or services does not constitute a license to use such products or services or a warranty or endorsement thereof.

### 10.2 Suitability in customer applications

The customer bears the responsibility for compliance of systems or units, in which Würth Elektronik eiSos GmbH & Co. KG products are integrated, with applicable legal regulations. Customer acknowledges and agrees that it is solely responsible for compliance with all legal, regulatory and safety-related requirements concerning its products, and any use of Würth Elektronik eiSos GmbH & Co. KG components in its applications, notwithstanding any applications-related information or support that may be provided by Würth Elektronik eiSos GmbH & Co. KG. Customer represents and agrees that it has all the necessary expertise to create and implement safeguards which anticipate dangerous consequences of failures, monitor failures and their consequences lessen the likelihood of failures that might cause harm and take appropriate remedial actions. The customer will fully indemnify Würth Elektronik eiSos GmbH & Co. KG and its representatives against any damages arising out of the use of any Würth Elektronik eiSos GmbH & Co. KG components in safety-critical applications.

### 10.3 Trademarks

AMBER wireless is a registered trademark of Würth Elektronik eiSos GmbH & Co. KG. All other trademarks, registered trademarks, and product names are the exclusive property of the respective owners.

### 10.4 Usage restriction

Würth Elektronik eiSos GmbH & Co. KG products have been designed and developed for usage in general electronic equipment only. This product is not authorized for use in equipment where a higher safety standard and reliability standard is especially required or where a failure of the product is reasonably expected to cause severe personal injury or death,

unless the parties have executed an agreement specifically governing such use. Moreover, Würth Elektronik eiSos GmbH & Co. KG products are neither designed nor intended for use in areas such as military, aerospace, aviation, nuclear control, submarine, transportation (automotive control, train control, ship control), transportation signal, disaster prevention, medical, public information network etc. Würth Elektronik eiSos GmbH & Co. KG must be informed about the intent of such usage before the design-in stage. In addition, sufficient reliability evaluation checks for safety must be performed on every electronic component, which is used in electrical circuits that require high safety and reliability function or performance. By using Würth Elektronik eiSos GmbH & Co. KG products, the customer agrees to these terms and conditions.

## 11 License terms

This License Terms will take effect upon the purchase and usage of the Würth Elektronik eiSos GmbH & Co. KG wireless connectivity products. You hereby agree that this license terms is applicable to the product and the incorporated software, firmware and source codes (collectively, "Software") made available by Würth Elektronik eiSos in any form, including but not limited to binary, executable or source code form.

The software included in any Würth Elektronik eiSos wireless connectivity product is purchased to you on the condition that you accept the terms and conditions of this license terms. You agree to comply with all provisions under this license terms.

### 11.1 Limited license

Würth Elektronik eiSos hereby grants you a limited, non-exclusive, non-transferable and royalty-free license to use the software and under the conditions that will be set forth in this license terms. You are free to use the provided Software only in connection with one of the products from Würth Elektronik eiSos to the extent described in this license terms. You are entitled to change or alter the source code for the sole purpose of creating an application embedding the Würth Elektronik eiSos wireless connectivity product. The transfer of the source code to third parties is allowed to the sole extent that the source code is used by such third parties in connection with our product or another hardware provided by Würth Elektronik eiSos under strict adherence of this license terms. Würth Elektronik eiSos will not assume any liability for the usage of the incorporated software and the source code. You are not entitled to transfer the source code in any form to third parties without prior written consent of Würth Elektronik eiSos.

You are not allowed to reproduce, translate, reverse engineer, decompile, disassemble or create derivative works of the incorporated Software and the source code in whole or in part. No more extensive rights to use and exploit the products are granted to you.

### 11.2 Usage and obligations

The responsibility for the applicability and use of the Würth Elektronik eiSos wireless connectivity product with the incorporated Firmware in a particular customer design is always solely within the authority of the customer. Due to this fact, it is up to you to evaluate and investigate, where appropriate, and to decide whether the device with the specific product characteristics described in the product specification is valid and suitable for your respective application or not.

You are responsible for using the Würth Elektronik eiSos wireless connectivity product with the incorporated Firmware in compliance with all applicable product liability and product safety laws. You acknowledge to minimize the risk of loss and harm to individuals and bear the risk for failure leading to personal injury or death due to your usage of the product.

Würth Elektronik eiSos' products with the incorporated Firmware are not authorized for use in safety-critical applications, or where a failure of the product is reasonably expected to cause severe personal injury or death. Moreover, Würth Elektronik eiSos' products with the incorporated Firmware are neither designed nor intended for use in areas such as military, aerospace, aviation, nuclear control, submarine, transportation (automotive control, train control, ship control), transportation signal, disaster prevention, medical, public information network etc. You shall inform Würth Elektronik eiSos about the intent of such usage before design-in stage. In certain customer applications requiring a very high level of safety and in which the malfunction or failure of an electronic component could endanger human life or

health, you must ensure to have all necessary expertise in the safety and regulatory ramifications of your applications. You acknowledge and agree that you are solely responsible for all legal, regulatory and safety-related requirements concerning your products and any use of Würth Elektronik eiSos' products with the incorporated Firmware in such safety-critical applications, notwithstanding any applications-related information or support that may be provided by Würth Elektronik eiSos. YOU SHALL INDEMNIFY WÜRTH ELEKTRONIK EISOS AGAINST ANY DAMAGES ARISING OUT OF THE USE OF WÜRTH ELEKTRONIK EISOS' PRODUCTS WITH THE INCORPORATED FIRMWARE IN SUCH SAFETY-CRITICAL APPLICATIONS.

### 11.3 Ownership

The incorporated Firmware created by Würth Elektronik eiSos is and will remain the exclusive property of Würth Elektronik eiSos.

### 11.4 Firmware update(s)

You have the opportunity to request the current and actual Firmware for a bought wireless connectivity Product within the time of warranty. However, Würth Elektronik eiSos has no obligation to update a modules firmware in their production facilities, but can offer this as a service on request. The upload of firmware updates falls within your responsibility, e.g. via ACC or another software for firmware updates. Firmware updates will not be communicated automatically. It is within your responsibility to check the current version of a firmware in the latest version of the product manual on our website. The revision table in the product manual provides all necessary information about firmware updates. There is no right to be provided with binary files, so called "Firmware images", those could be flashed through JTAG, SWD, Spi-Bi-Wire, SPI or similar interfaces.

### 11.5 Disclaimer of warranty

THE FIRMWARE IS PROVIDED "AS IS". YOU ACKNOWLEDGE THAT WÜRTH ELEKTRONIK EISOS MAKES NO REPRESENTATIONS AND WARRANTIES OF ANY KIND RELATED TO, BUT NOT LIMITED TO THE NON-INFRINGEMENT OF THIRD PARTIES' INTELLECTUAL PROPERTY RIGHTS OR THE MERCHANTABILITY OR FITNESS FOR YOUR INTENDED PURPOSE OR USAGE. WÜRTH ELEKTRONIK EISOS DOES NOT WARRANT OR REPRESENT THAT ANY LICENSE, EITHER EXPRESS OR IMPLIED, IS GRANTED UNDER ANY PATENT RIGHT, COPYRIGHT, MASK WORK RIGHT, OR OTHER INTELLECTUAL PROPERTY RIGHT RELATING TO ANY COMBINATION, MACHINE, OR PROCESS IN WHICH THE WÜRTH ELEKTRONIK EISOS' PRODUCT WITH THE INCORPORATED FIRMWARE IS USED. INFORMATION PUBLISHED BY WÜRTH ELEKTRONIK EISOS REGARDING THIRD-PARTY PRODUCTS OR SERVICES DOES NOT CONSTITUTE A LICENSE FROM WÜRTH ELEKTRONIK EISOS TO USE SUCH PRODUCTS OR SERVICES OR A WARRANTY OR ENDORSEMENT THEREOF.

### 11.6 Limitation of liability

Any liability not expressly provided by Würth Elektronik eiSos shall be disclaimed. You agree to hold us harmless from any third-party claims related to your usage of the Würth Elektronik eiSos' products with the incorporated Firmware, software and source code. Würth

Elektronik eiSos disclaims any liability for any alteration, development created by you or your customers as well as for any combination with other products.

## 11.7 Applicable law and jurisdiction

Applicable law to this license terms shall be the laws of the Federal Republic of Germany. Any dispute, claim or controversy arising out of or relating to this license terms shall be resolved and finally settled by the court competent for the location of Würth Elektronik eiSos' registered office.

## 11.8 Severability clause

If a provision of this license terms is or becomes invalid, unenforceable or null and void, this shall not affect the remaining provisions of the terms. The parties shall replace any such provisions with new valid provisions that most closely approximate the purpose of the terms.

## 11.9 Miscellaneous

Würth Elektronik eiSos reserves the right at any time to change this terms at its own discretion. It is your responsibility to check at Würth Elektronik eiSos homepage for any updates. Your continued usage of the products will be deemed as the acceptance of the change.

We recommend you to be updated about the status of new firmware and software, which is available on our website or in our data sheet and manual, and to implement new software in your device where appropriate.

By ordering a wireless connectivity product, you accept this license terms in all terms.

## List of Figures

1	Thetis-I USB radio stick: product image . . . . .	6
2	Thetis-I mini evaluation board: product image . . . . .	7
3	Thetis-I sensor node: product image . . . . .	7
4	Network setup . . . . .	8
5	Placement of Thetis-I USB Radio Stick . . . . .	9
6	Connection between nodes . . . . .	9
7	Roles and position of the devices . . . . .	10
8	Open COM port . . . . .	11
9	Configure the sink . . . . .	11
10	Start the sink . . . . .	11
11	Sensor data . . . . .	12
12	Sensor data chart . . . . .	12
13	Transmit data to the sink . . . . .	13
14	Block diagram . . . . .	14
15	Connectors and pin headers . . . . .	16
16	Capacitor connection to external antenna . . . . .	20
17	Capacitor connection to internal antenna . . . . .	21
18	Jumpers . . . . .	22
19	Buttons . . . . .	24
20	LFXO . . . . .	26
21	LFXO assembly . . . . .	27
22	Schematic sheet . . . . .	28
23	Assembly . . . . .	29
24	Top,bottom & internal layers . . . . .	30
25	Block diagram . . . . .	32
26	Block diagram . . . . .	33
27	Connectors and pin headers . . . . .	34
28	Battery holder for CR2032 coin cell . . . . .	35
29	Reset pad on on the top layer . . . . .	36
30	Reset pad on the bottom layer . . . . .	36
31	Assembled sensors . . . . .	38
32	Example: Set the period to 30s . . . . .	40
33	Example: Set format to DATA_FORMAT_FULL_ASCII_STRING . . . . .	40
34	Flow chart: Remote writing CSAP and MSAP attributes . . . . .	42
35	Example: Set the node role to "Low Energy Router node" - remote command configuration . . . . .	42
36	Example: Set the node role to "Low Energy Router node" - Status Window . . . . .	43
37	Example: Read network address - remote command configuration . . . . .	43
38	Example: Read network address - Status Window . . . . .	43
39	Schematic sheet . . . . .	44
40	Assembly on top layer . . . . .	45
41	Assembly on bottom layer . . . . .	45
42	Layout top layer . . . . .	46
43	Layout bottom layer . . . . .	46
44	Optional enclosure mounting . . . . .	47
45	Würth Elektronik eiSos test network topology . . . . .	50

## List of Tables

1	Compatibility . . . . .	6
2	Content Thetis-I Wirepas EV-kit . . . . .	6
3	Default assembled connectors . . . . .	16
4	Additional assembly components . . . . .	17
5	Pin header P1 . . . . .	18
6	Pin header P2 . . . . .	18
7	Pin header P3 . . . . .	18
8	Pin header P4 . . . . .	19
9	Pin header P5 . . . . .	19
10	JTAG debugging interface . . . . .	19
11	Pin header SMA . . . . .	20
12	Pin header JP1 . . . . .	23
13	Pin header JP1 Power LED . . . . .	23
14	Pin header JP1 Power supply selection . . . . .	23
15	Power supply option . . . . .	25
16	Placeholder for 2.54mm pin header . . . . .	34
17	Pin header J2 . . . . .	35
18	LED behaviour . . . . .	37
19	Sensors assembled on the sensor node board . . . . .	38
20	Sensors assembled on the sensor node board . . . . .	38
21	article list . . . . .	47
22	Würth Elektronik eiSos test network: key parameters . . . . .	49
23	Würth Elektronik eiSos test network: Status . . . . .	51





# more than you expect



**Internet  
of Things**



**Monitoring  
& Control**



**Automated Meter  
Reading**

**Contact:**

Würth Elektronik eiSos GmbH & Co. KG  
Division Wireless Connectivity & Sensors

Max-Eyth-Straße 1  
74638 Waldenburg  
Germany

Tel.: +49 651 99355-0  
Fax.: +49 651 99355-69  
[www.we-online.com/wireless-connectivity](http://www.we-online.com/wireless-connectivity)

