

Supply and remote module - PT-IQ-PTB-UT - 2800768

Please be informed that the data shown in this PDF Document is generated from our Online Catalog. Please find the complete data in the user's documentation. Our General Terms of Use for Downloads are valid (<http://phoenixcontact.com/download>)



Module for power supply and multi-stage, floating remote signaling of connected surge protection modules.

Your advantages

- Surge protection system
- Multi-level state monitoring
- System supplied via DIN rail bus
- Up to 28 protection modules per supply module
- Maximum ease of maintenance thanks to the two-piece design
- Codable plug
- Impedance-neutral disconnection of plug for maintenance purposes
- Base element remains an integral part of the installation



Key Commercial Data

Packing unit	1 pc
GTIN	 4 046356 647984
GTIN	4046356647984

Technical data

Dimensions

Height	91.1 mm
Width	17.7 mm
Depth	77.5 mm (incl. DIN rail 7.5 mm)
Horizontal pitch	1 Div.

Ambient conditions

Ambient temperature (operation)	-40 °C ... 70 °C
Ambient temperature (storage/transport)	-40 °C ... 85 °C
Altitude	≤ 4000 m (amsl (above mean sea level))

Supply and remote module - PT-IQ-PTB-UT - 2800768

Technical data

Ambient conditions

Degree of protection	IP20
----------------------	------

General

Housing material	PA 6.6
Flammability rating according to UL 94	V-0
Color	jet black RAL 9005
Mounting type	DIN rail: 35 mm
Type	DIN rail module, two-section, divisible

Additional descriptions

Note	Remote signaling as well as the power supply of the DIN rail connector are established by snapping the module into place on the DIN rail connector.
------	---

Protective circuit

Surge protection fault message	Optical, multi-stage remote indication contact
--------------------------------	--

Connection data

Connection method	Screw connection
Screw thread	M3
Tightening torque	0.5 Nm
Stripping length	8 mm
Conductor cross section flexible	0.2 mm ² ... 2.5 mm ²
Conductor cross section solid	0.2 mm ² ... 4 mm ²
Conductor cross section AWG	24 ... 12

Connection, equipotential bonding

Connection method	DIN rail NS35
-------------------	---------------

Remote indication contact

Switching function	2x N/C contacts
Connection method	Screw connection
Screw thread	M3
Tightening torque	0.5 Nm
Stripping length	8 mm
Conductor cross section flexible	0.2 mm ² ... 2.5 mm ²
Conductor cross section solid	0.2 mm ² ... 4 mm ²
Conductor cross section AWG	24 ... 14

Supply status indicator / remote signaling

Operating voltage	20 V DC ... 30 V DC
Rated current	max. 130 mA (24 V DC)
	max. 160 mA (20 V DC)
Max. required back-up fuse	500 mA (T)
Number of surge protection modules that can be mounted side by side	28 (32 °C)

Supply and remote module - PT-IQ-PTB-UT - 2800768

Technical data

Standards and Regulations

Standards/specifications	EN 61000-6-2 2005
	EN 61000-6-3 2007 + A1:2011
	EN 60950-1 2006 + A2:2013
	EN 60079-0 2012
	EN 60079-11 2012
	EN 60079-15 2010
	EN 60079-26 2007
	IEC 60079-0 2011 (modified) + corrigendum 2012
	IEC 60079-11 2011 + Corrigendum 2012
	IEC 60079-15 2010
	IEC 60079-26 2006

Environmental Product Compliance

	Lead 7439-92-1
China RoHS	Environmentally Friendly Use Period = 50
	For details about hazardous substances go to tab "Downloads", Category "Manufacturer's declaration"

Drawings

Supply and remote module - PT-IQ-PTB-UT - 2800768

Schematic diagram

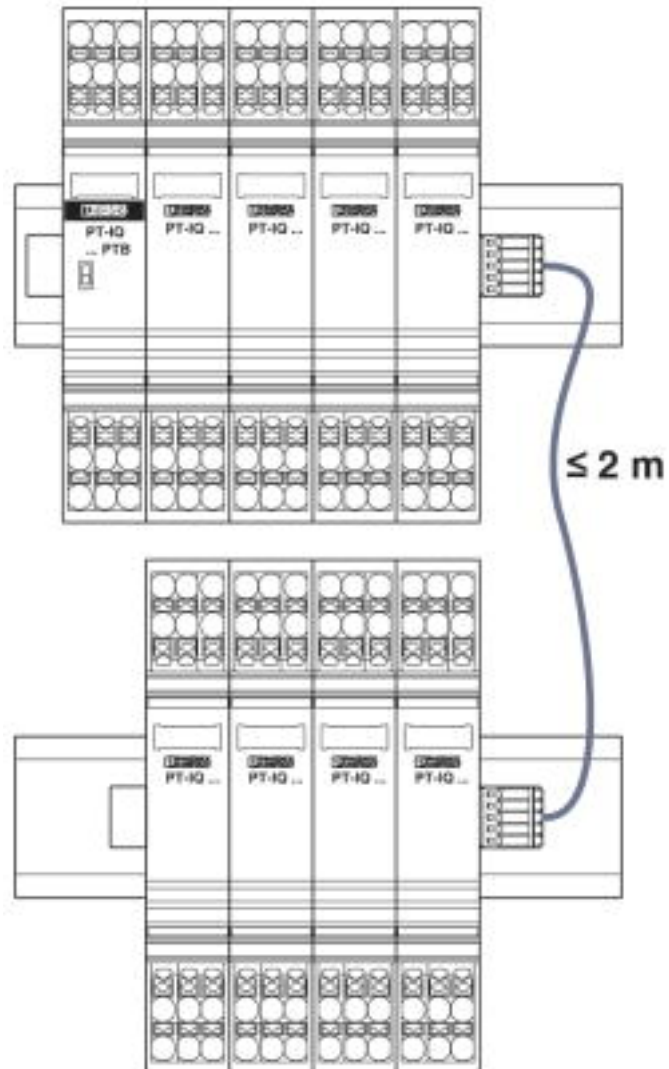

Supply and remote module - PT-IQ-PTB-UT - 2800768

Application drawing

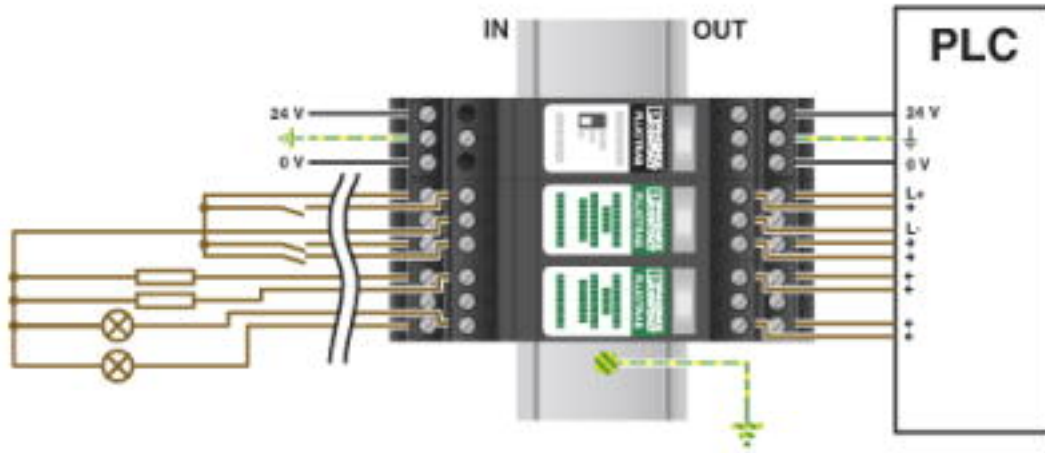

Diagram

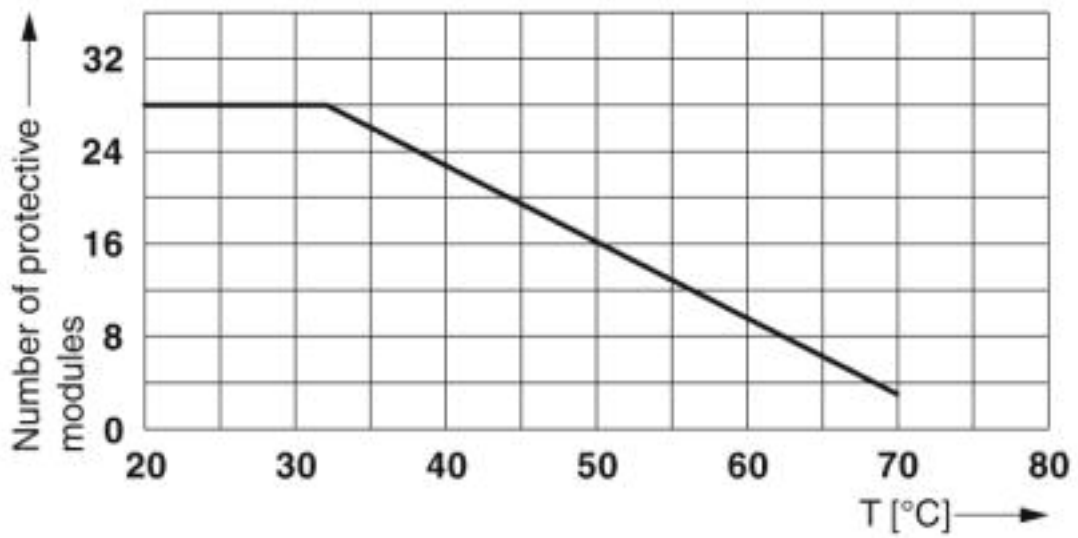

Alignable protection modules depending on the ambient temperature in "non-Ex" installations

Supply and remote module - PT-IQ-PTB-UT - 2800768

Dimensional drawing

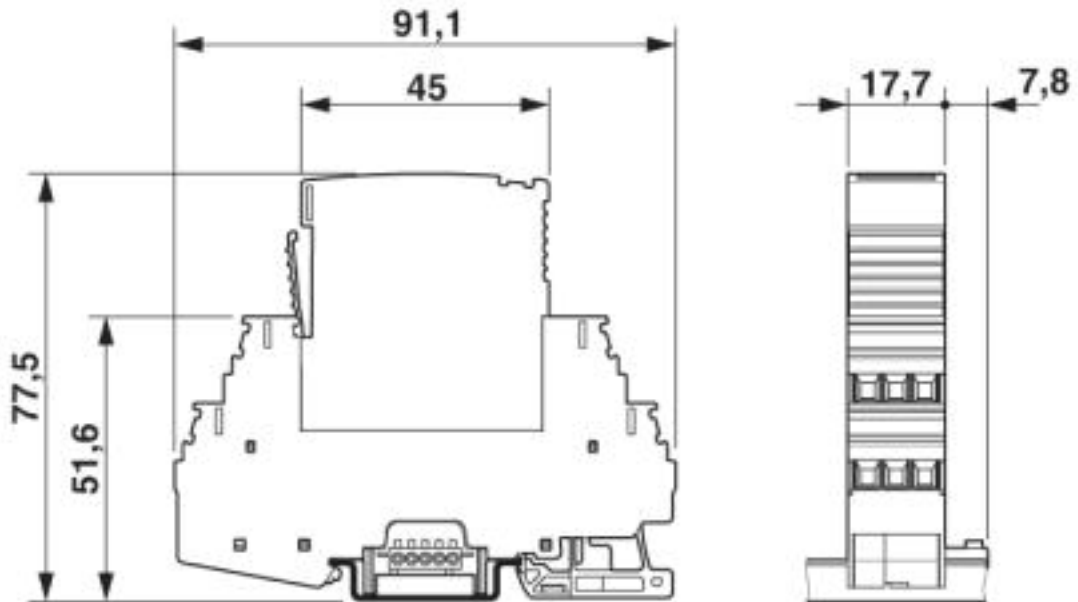

Circuit diagram

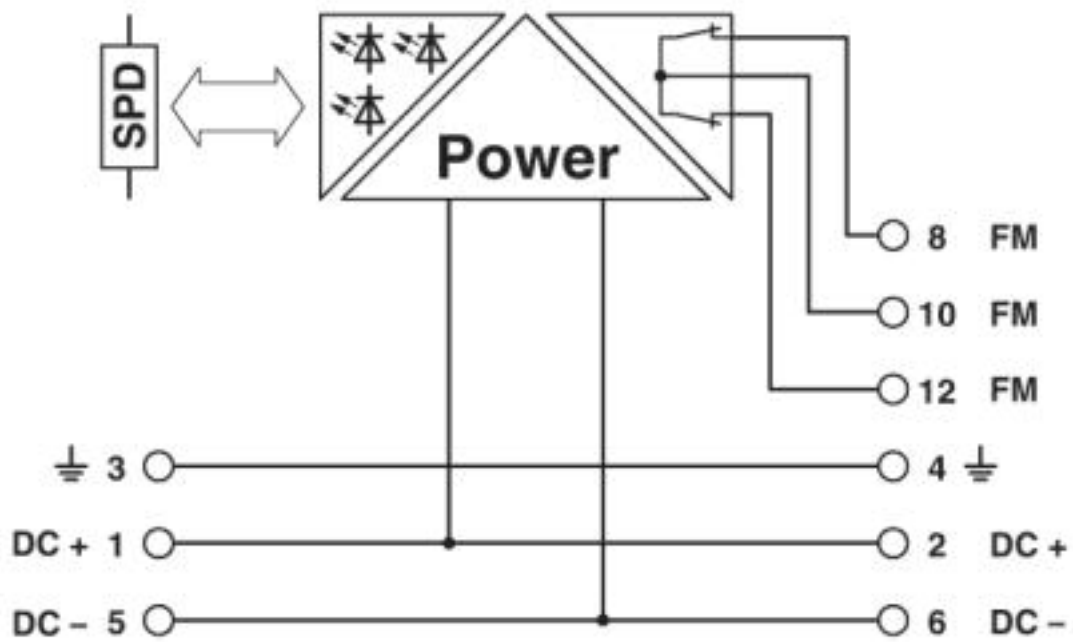

Supply and remote module - PT-IQ-PTB-UT - 2800768

Application drawing

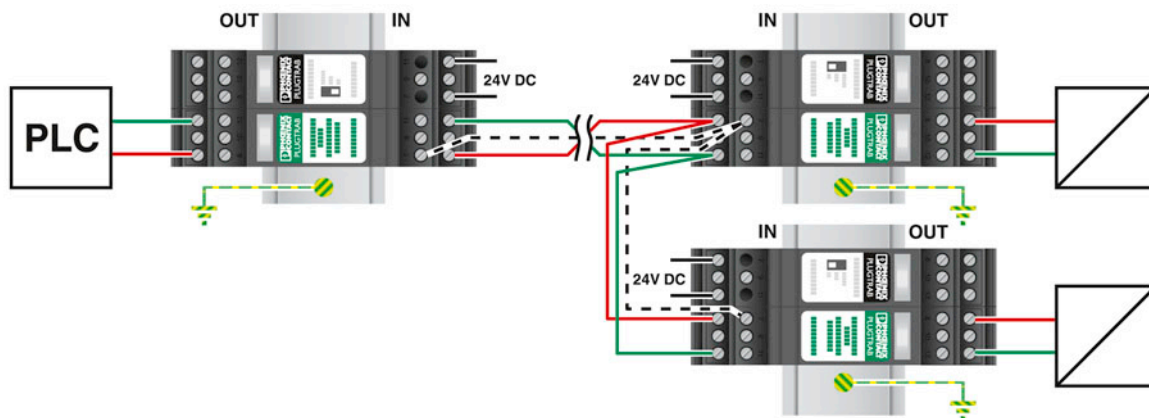

Approvals

Approvals

Approvals

CSA / UL Listed / CSAus / EAC / EAC / cCSAus

Ex Approvals





IECEX / ATEX / UL Listed / cUL Listed / cULus Listed

Approval details

CSA		http://www.csagroup.org/services-industries/product-listing/	2761632
-----	--	---	---------

Supply and remote module - PT-IQ-PTB-UT - 2800768

Approvals

UL Listed		http://database.ul.com/cgi-bin/XYV/template/LISEXT/1FRAME/index.htm	FILE E 138168
CSAus		http://www.csagroup.org/services-industries/product-listing/	2761632
EAC			EAC-Zulassung
EAC			RU C- DE.A*30.B01561
cCSAus			

Phoenix Contact 2019 © - all rights reserved
<http://www.phoenixcontact.com>

PHOENIX CONTACT GmbH & Co. KG
Flachsmarktstr. 8
32825 Blomberg
Germany
Tel. +49 5235 300
Fax +49 5235 3 41200
<http://www.phoenixcontact.com>