

Subject to changes. Please also observe the further product documentation!

WAGO GmbH & Co. KG  
Hansastr. 27  
32423 Minden  
Phone: +49571 887-0 | Fax: +49571 887-169  
Email: [info.de@wago.com](mailto:info.de@wago.com) | Web: [www.wago.com](http://www.wago.com)

Do you have any questions about our products?  
We are always happy to take your call at +49 (571) 887-44222.

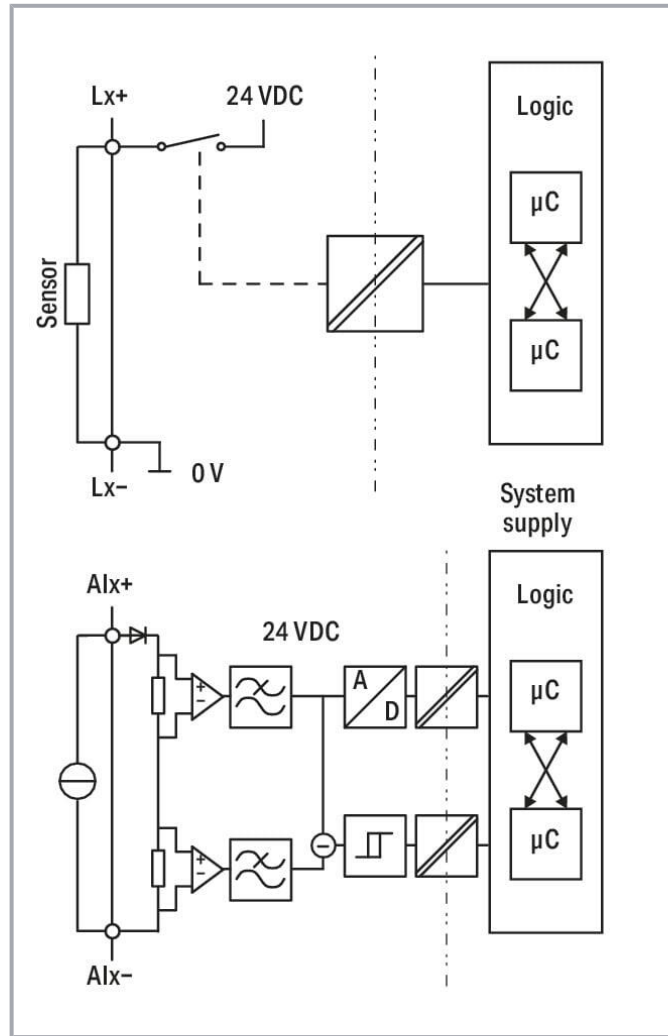
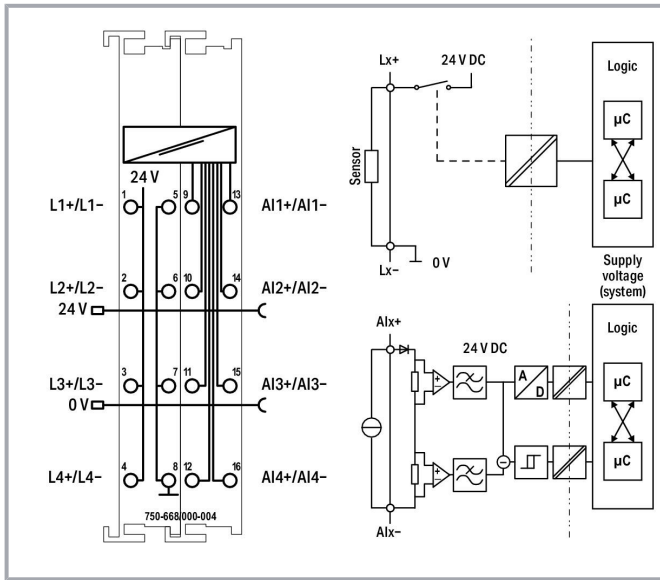

Subject to changes. Please also observe the further product documentation!

WAGO GmbH & Co. KG  
 Hansastr. 27  
 32423 Minden  
 Phone: +49571 887-0 | Fax: +49571 887-169  
 Email: info.de@wago.com | Web: www.wago.com

Do you have any questions about our products?  
 We are always happy to take your call at +49 (571) 887-44222.

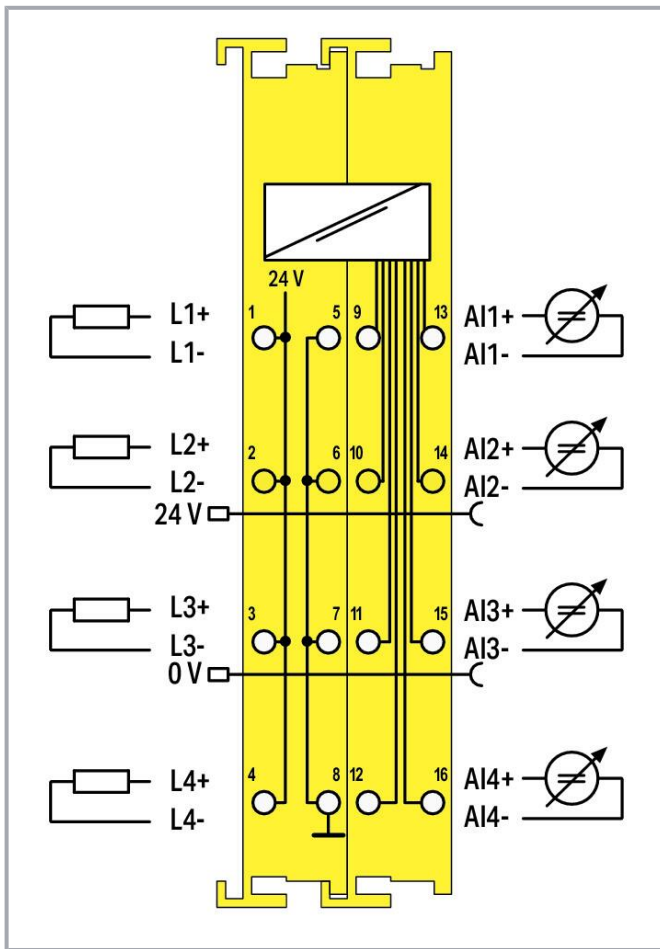

### Item description

The 75x-668/000-004 Module features four differential fail-safe analog inputs (AI1 ... AI4) and four current-limited sensor supply outputs (L1 ... L4). The sensors can be supplied directly by the module or via external 24 V. The fail-safe analog inputs can be used either in single-channel (up to SIL2 /PLd) or dual-channel mode (up to SIL3/PLe). Measurement cycle, filter times, encoder evaluation with discrepancy times and tolerance windows can be adjusted to meet the safety function requirements.

Overcurrent, overload and wire break are monitored at the fail-safe analog inputs. Both the monitoring and additional safety-relevant functions can be parameterized via *WAGO-I/O-CHECK*.

This configuration tool can be conveniently integrated into engineering systems supporting TCI (Tool Calling Interface) with CC2 or CC3.

When exchanging a module, parameters are automatically downloaded from the controller via PROFIsafe-compatible iPar server.

The PROFIsafe address can be set using the DIP switch or via *WAGO-I/O-CHECK*.

The module supports both PROFIsafe V2.4 (PROFIBUS) and V2.6 (PROFINET) protocols.

Individual input modules can be arranged in any combination when configuring the fieldbus node.

**If, for example, the cable length of the 24 V supply is greater than 3 m, a WAGO Filter Module or an appropriate external filter must be used for the 24 V power supply to protect the module against surge and burst (per IEC 61000-6-7 and marine applications).**

**Additional information can be found in the product manual (available in German and English)!**

Subject to changes. Please also observe the further product documentation!

WAGO GmbH & Co. KG

Hansastr. 27

32423 Minden

Phone: +49571 887-0 | Fax: +49571 887-169

Email: [info.de@wago.com](mailto:info.de@wago.com) | Web: [www.wago.com](http://www.wago.com)

Do you have any questions about our products?

We are always happy to take your call at +49 (571) 887-44222.



## Data Notes

Note	Pluggable connectors and coding fingers (753 Series) are not included.
------	--

## Technical data

Device-specific	Common mode rejection: 87 dB (typ.); Sampling frequency 100 Hz, 60 Hz, 50 Hz, 10 Hz; configurable; Interference frequency suppression 38 dB at 50 Hz/60 Hz; Safety-related accuracy 1.25 % of the upper-range value (single-channel); 1.58 % of the upper-range value (two-channel)
Number of analog inputs	4
Total number of channels (module)	4
Signal type	Current
Signal type (current)	0 ... 20 mA; 4 ... 20 mA
Sensor supply	Outputs L1 ... L4
Sensor connection	4 x (2-wire, 3-wire, 4-wire)
Output current per channel	1.5 A
Output current (module)	1.5 A
Signal characteristics	Differential
Resolution [bit]	16 bits
Common-mode voltage (max.)	60 V
Load impedance	300 Ω
Measurement error (reference temperature)	25 °C
Measurement error, deviation (max.) from the upper-range value	0.05 %
Temperature error (max.) of the upper-range value	0.006 %/K
Configuration options	PROFIsafe address adjustable via DIP switch or engineering software
Supply voltage (system)	5 VDC; via data contacts
Current consumption (5 V system supply)	120 mA
Supply voltage (field)	24 VSELV/PELV DC (-15 ... +30 %); via power jumper contacts (power supply via blade contact; transmission via spring contact)
Current consumption, field supply (module with no external load)	40 mA
Isolation	500 V system/field
Indicators	LED (E) red, LED (F-H) red/green: Diagnostics; LED (I-M) red/green: Input/output status

Subject to changes. Please also observe the further product documentation!



Number of incoming power jumper contacts	2
Number of outgoing power jumper contacts	2
Current carrying capacity (power jumper contacts)	10 A
Current carrying capacity	40 mA

### Functional safety

Achievable safety classes	SIL 3; Category 4, PLe (two-channel); SIL 2; Category 2; PLd (one-channel)
Safety standards	IEC 61508-1 ... -7; EN ISO 13849-1; EN 62061

### Connection data

Connection type 1	Inputs/Outputs
Solid conductor	0.08 ... 2.5 mm <sup>2</sup> / 28 ... 14 AWG
Fine-stranded conductor	0.08 ... 2.5 mm <sup>2</sup> / 28 ... 14 AWG
Strip length	9 ... 10 mm / 0.35 ... 0.39 inches

### Physical data

Width	24 mm / 0.945 inches
Height	100 mm / 3.937 inches
Depth	69 mm / 2.717 inches
Depth from upper-edge of DIN-rail	61.8 mm / 2.433 inches

### Mechanical Data

Mounting type	DIN-35 rail
---------------	-------------

### Material Data

Housing material	Polycarbonate; polyamide 6.6
Fire load	1.665 MJ
Weight	84.2 g
Conformity marking	CE

### Environmental requirements

Ambient temperature (operation)	0 ... +55 °C
Ambient temperature (storage)	-25 ... +85 °C
Protection type	IP20
Pollution degree	2 per IEC 61131-2

Subject to changes. Please also observe the further product documentation!



Operating altitude	0 ... 2000 m / 0 ... 6562 ft
Mounting position	horizontal (standing/lying); vertical
Relative humidity (without condensation)	95 %
Shock resistance	15g per IEC 60068-2-27
EMC immunity to interference	per EN 61000-6-2, marine applications, EN 61000-6-7 (FS)
EMC emission of interference	per EN 61000-6-4, marine applications, EN 61000-6-3
Exposure to pollutants	Per IEC 60068-2-42 and IEC 60068-2-43





**Commercial data**

ETIM 8.0	EC001596
ETIM 7.0	EC001596
PU (SPU)	1 pcs
Packaging type	box
Country of origin	DE
GTIN	4055143899819
Customs tariff number	85389099990

**Environmental Product Compliance**

RoHS Compliance Status	Compliant, No Exemption
------------------------	-------------------------

**Approvals / Certificates****General approvals**

Logo	Approval	Additional Approval Text	Certificate name
	CCC CNEX	CNCA-C23-01	2020312310000213 (Ex ec IIC T4 Gc)
	EAC Brjansker Zertifizierungsstelle	TP TC 020/2011	EAC RU C-DE.AM02. B.00087/19
	EAC Brjansker Zertifizierungsstelle	TP TC 012/2011	EAC RU C-DE.AZ58. B.2173-21 e (2Ex e IIC T4 Gc X)
	UL Underwriters Laboratories Inc. (ORDINARY LOCATIONS)	UL 61010-2-201	E175199

Subject to changes. Please also observe the further product documentation!

WAGO GmbH & Co. KG  
Hansastr. 27  
32423 Minden  
Phone: +49571 887-0 | Fax: +49571 887-169  
Email: [info.de@wago.com](mailto:info.de@wago.com) | Web: [www.wago.com](http://www.wago.com)



Do you have any questions about our products?  
We are always happy to take your call at +49 (571) 887-44222.





UL  
Underwriters Laboratories Inc. (ORDINARY  
LOCATIONS)

E175199



## Declarations of conformity and manufacturer's declarations

Logo	Approval	Additional Approval Text	Certificate name
	EU-Declaration of Conformity WAGO GmbH & Co. KG	-	-
	UK-Declaration of Conformity WAGO GmbH & Co. KG	-	-

## Approvals for marine applications

Logo	Approval	Additional Approval Text	Certificate name
	BSH Bundesamt fuer Seeschifffahrt und Hydrographie	-	1104
	DNV DNV GL SE	DNV-CG-0339, Aug. 2021	TAA0000194

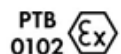
## Approvals for hazardous areas

Logo	Approval	Additional Approval Text	Certificate name
	ATEX TUEV Nord Cert GmbH	EN 60079-0	TUEV_14_ATEX_148929_X (II 3 G Ex ec IIC T4 Gc)
	CCC CNEX	CNCA-C23-01	2020312310000213 (Ex ec IIC T4 Gc)
	IECEX TUEV Nord Cert GmbH	IEC 60079-0	IECEX TUN 14.0035 X (Ex ec IIC T4 Gc)
	INMETRO	IEC 60079-0	BR-Ex_TÜV 12.1297 X

Subject to changes. Please also observe the further product documentation!

WAGO GmbH & Co. KG  
Hansastr. 27  
32423 Minden  
Phone: +49571 887-0 | Fax: +49571 887-169  
Email: [info.de@wago.com](mailto:info.de@wago.com) | Web: [www.wago.com](http://www.wago.com)

Do you have any questions about our products?  
We are always happy to take your call at +49 (571) 887-44222.



TÜV Rheinland do Brasil Ltda.



UKEx  
WAGO GmbH & Co. KG

EN 60079-0

UKCA\_WAGO22UKEX003X\_ec





UL  
Underwriters Laboratories Inc. (HAZARDOUS  
LOCATIONS)

UL 121201

E198726 Sec.1

### Approvals for functional safety

Logo	Approval	Additional Approval Text	Certificate name
	<b>Prod. Safety, Funct. Safety</b> TUEV Rheinland Industrie Service GmbH	-	No. 968 /EZ 247.18 /21
	<b>Profi-Safe</b> Siemens AG/ComDeC	-	Z20240

### Required accessories

#### Pluggable connector

Male connector/plug





**Item no.: 753-120**  
Plug; Safety

[www.wago.com/753-120](http://www.wago.com/753-120)

### Optional accessories

#### Supply module

Supply module

	<b>Item no.: 750-601</b> Power Supply; 24 VDC; fuse holder	<a href="http://www.wago.com/750-601">www.wago.com/750-601</a>
	<b>Item no.: 750-610</b> Power Supply; 24 VDC; fuse holder; Diagnostics	<a href="http://www.wago.com/750-610">www.wago.com/750-610</a>
	<b>Item no.: 750-602</b> Power Supply; 24 VDC	<a href="http://www.wago.com/750-602">www.wago.com/750-602</a>

Subject to changes. Please also observe the further product documentation!

WAGO GmbH & Co. KG  
Hansastr. 27  
32423 Minden  
Phone: +49571 887-0 | Fax: +49571 887-169  
Email: [info.de@wago.com](mailto:info.de@wago.com) | Web: [www.wago.com](http://www.wago.com)

Do you have any questions about our products?  
We are always happy to take your call at +49 (571) 887-44222.



	<b>Item no.: 750-612</b> Power Supply; 0 ... 230 V AC/DC	<a href="http://www.wago.com/750-612">www.wago.com/750-612</a>
---	---	--

	<b>Item no.: 753-612</b> Power Supply; 0 ... 230 V AC/DC	<a href="http://www.wago.com/753-612">www.wago.com/753-612</a>
---	---	--

	<b>Item no.: 753-602</b> Power Supply; 24 VDC	<a href="http://www.wago.com/753-602">www.wago.com/753-602</a>
---	--	--

### System housing

#### System enclosure

	<b>Item no.: 850-814/002-000</b> IP65 enclosure; Sheet steel (RAL 7035); WxHxD (200x120x200 mm); without flange plate	<a href="http://www.wago.com/850-814/002-000">www.wago.com/850-814/002-000</a>
--	--	--

	<b>Item no.: 850-815/002-000</b> IP65 enclosure; Sheet steel (RAL 7035); WxHxD (300x120x200 mm); without flange plate	<a href="http://www.wago.com/850-815/002-000">www.wago.com/850-815/002-000</a>
--	--	--

	<b>Item no.: 850-816/002-000</b> IP65 enclosure; Sheet steel (RAL 7035); WxHxD (400x120x200 mm); without flange plate	<a href="http://www.wago.com/850-816/002-000">www.wago.com/850-816/002-000</a>
--	--	--

	<b>Item no.: 850-817/002-000</b> IP65 enclosure; Sheet steel (RAL 7035); WxHxD (600x120x200 mm); without flange plate	<a href="http://www.wago.com/850-817/002-000">www.wago.com/850-817/002-000</a>
--	--	--

	<b>Item no.: 850-825</b> IP65 enclosure; Aluminium (RAL 7032); WxHxD (160x100x160 mm); 9 x M12, 4 x M20	<a href="http://www.wago.com/850-825">www.wago.com/850-825</a>
---	--	--

	<b>Item no.: 850-826</b> IP65 enclosure; Aluminium (RAL 7032); WxHxD (240x100x160 mm); 4 x M20, 4 x M16, 14 x M12 cable grip	<a href="http://www.wago.com/850-826">www.wago.com/850-826</a>
--	---	--

	<b>Item no.: 850-827</b> IP65 enclosure; Aluminium (RAL 7032); WxHxD (320x100x160 mm); 4 x M20, 8 x M16, 17 x M12 cable grip	<a href="http://www.wago.com/850-827">www.wago.com/850-827</a>
--	---	--

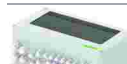
	<b>Item no.: 850-826/002-000</b> IP65 enclosure; Aluminium (RAL 7035); WxHxD (240x100x160 mm); 4 x M20, 4 x M16, 14 x M12 cable grip	<a href="http://www.wago.com/850-826/002-000">www.wago.com/850-826/002-000</a>
--	---	--

### Marking accessories

#### Marker carrier

	<b>Item no.: 750-103</b> Group marker carrier	<a href="http://www.wago.com/750-103">www.wago.com/750-103</a>
---	--	--

#### Marker

	<b>Item no.: 248-501/000-006</b> Mini-WSB marking card; as card; not stretchable; plain; snap-on type; blue	<a href="http://www.wago.com/248-501/000-006">www.wago.com/248-501/000-006</a>
--	--	--

Subject to changes. Please also observe the further product documentation!



**Item no.: 248-501/000-007**  
Mini-WSB marking card; as card; not stretchable; plain; snap-on type; gray

[www.wago.com/248-501/000-007](http://www.wago.com/248-501/000-007)



**Item no.: 248-501/000-002**  
Mini-WSB marking card; as card; not stretchable; plain; snap-on type; yellow

[www.wago.com/248-501/000-002](http://www.wago.com/248-501/000-002)



**Item no.: 248-501/000-012**  
Mini-WSB marking card; as card; not stretchable; plain; snap-on type; orange

[www.wago.com/248-501/000-012](http://www.wago.com/248-501/000-012)



**Item no.: 248-501**  
Mini-WSB marking card; as card; not stretchable; plain; snap-on type; white

[www.wago.com/248-501](http://www.wago.com/248-501)



**Item no.: 248-501/000-017**  
Mini-WSB marking card; as card; not stretchable; plain; snap-on type; light green

[www.wago.com/248-501/000-017](http://www.wago.com/248-501/000-017)



**Item no.: 248-501/000-005**  
Mini-WSB marking card; as card; not stretchable; plain; snap-on type; red

[www.wago.com/248-501/000-005](http://www.wago.com/248-501/000-005)



**Item no.: 248-501/000-024**  
Mini-WSB marking card; as card; not stretchable; plain; snap-on type; violet

[www.wago.com/248-501/000-024](http://www.wago.com/248-501/000-024)



**Item no.: 248-501/000-023**  
Mini-WSB marking card; as card; not stretchable; plain; snap-on type; green

[www.wago.com/248-501/000-023](http://www.wago.com/248-501/000-023)

Group marker carrier



**Item no.: 750-107**  
Group marker carrier

[www.wago.com/750-107](http://www.wago.com/750-107)

## Shield termination

Shield clamping saddles



**Item no.: 790-116**  
Shield clamping saddle; 19 mm wide; diameter of compatible conductor; 7 ... 16 mm

[www.wago.com/790-116](http://www.wago.com/790-116)



**Item no.: 790-124**  
Shield clamping saddle; 27 mm wide; diameter of compatible conductor; 6 ... 24 mm

[www.wago.com/790-124](http://www.wago.com/790-124)



**Item no.: 790-108**  
Shield clamping saddle; 11 mm wide; diameter of compatible conductor; 3 ... 8 mm















[www.wago.com/790-108](http://www.wago.com/790-108)



**Item no.: 790-140**  
Shield clamping saddle; diameter of compatible conductor

[www.wago.com/790-140](http://www.wago.com/790-140)

Subject to changes. Please also observe the further product documentation!

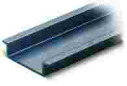
	<b>Item no.: 790-216</b> Shield clamping saddle; 21.8 mm wide; 6 ... 16 mm	<a href="http://www.wago.com/790-216">www.wago.com/790-216</a>
	<b>Item no.: 790-220</b> Shield clamping saddle; 30 mm wide; 6 ... 20 mm	<a href="http://www.wago.com/790-220">www.wago.com/790-220</a>
	<b>Item no.: 790-208</b> Shield clamping saddle; 12.4 mm wide; 3 ... 8 mm	<a href="http://www.wago.com/790-208">www.wago.com/790-208</a>
<b>Carrier rail</b>		
Mounting accessories		
	<b>Item no.: 210-197</b> Steel carrier rail; 35 x 15 mm; 1.5 mm thick; 2 m long; slotted; similar to EN 60715; silver-colored	<a href="http://www.wago.com/210-197">www.wago.com/210-197</a>
	<b>Item no.: 210-198</b> Copper carrier rail; 35 x 15 mm; 2.3 mm thick; 2 m long; unslotted; according to EN 60715; copper-colored	<a href="http://www.wago.com/210-198">www.wago.com/210-198</a>
	<b>Item no.: 210-504</b> Steel carrier rail; 35 x 7.5 mm; 1 mm thick; 2 m long; slotted; galvanized; according to EN 60715; silver-colored	<a href="http://www.wago.com/210-504">www.wago.com/210-504</a>
	<b>Item no.: 210-505</b> Steel carrier rail; 35 x 7.5 mm; 1 mm thick; 2 m long; unslotted; galvanized; according to EN 60715; silver-colored	<a href="http://www.wago.com/210-505">www.wago.com/210-505</a>
	<b>Item no.: 210-506</b> Steel carrier rail; 35 x 15 mm; 1.5 mm thick; 2 m long; unslotted; galvanized; similar to EN 60715; silver-colored	<a href="http://www.wago.com/210-506">www.wago.com/210-506</a>
	<b>Item no.: 210-508</b> Steel carrier rail; 35 x 15 mm; 1.5 mm thick; 2 m long; slotted; galvanized; similar to EN 60715; silver-colored	<a href="http://www.wago.com/210-508">www.wago.com/210-508</a>
	<b>Item no.: 210-113</b> Steel carrier rail; 35 x 7.5 mm; 1 mm thick; 2 m long; unslotted; according to EN 60715; silver-colored	<a href="http://www.wago.com/210-113">www.wago.com/210-113</a>
	<b>Item no.: 210-118</b> Steel carrier rail; 35 x 15 mm; 2.3 mm thick; 2 m long; unslotted; according to EN 60715; silver-colored	<a href="http://www.wago.com/210-118">www.wago.com/210-118</a>
	<b>Item no.: 210-112</b> Steel carrier rail; 35 x 7.5 mm; 1 mm thick; 2 m long; slotted; according to EN 60715; "Hole width 25 mm; silver-colored	<a href="http://www.wago.com/210-112">www.wago.com/210-112</a>
	<b>Item no.: 210-114</b> Steel carrier rail; 35 x 15 mm; 1.5 mm thick; 2 m long; unslotted; similar to EN 60715; silver-colored	<a href="http://www.wago.com/210-114">www.wago.com/210-114</a>
	<b>Item no.: 210-115</b> Steel carrier rail; 35 x 7.5 mm; 1 mm thick; 2 m long; slotted; according to EN 60715; "Hole width 18 mm; silver-colored	<a href="http://www.wago.com/210-115">www.wago.com/210-115</a>
	<b>Item no.: 210-196</b> Aluminum carrier rail; 35 x 8.2 mm; 1.6 mm thick; 2 m long; unslotted; similar to EN 60715; silver-colored	<a href="http://www.wago.com/210-196">www.wago.com/210-196</a>

Subject to changes. Please also observe the further product documentation!

## Pluggable connector

## Coding



Item no.: 753-150  
753 Series coding elements

[www.wago.com/753-150](http://www.wago.com/753-150)

## Downloads

## Documentation

## Data sheet

753-668/000-004 4FAI 0/4-20 mA Diff PROFIsafe	pdf	Download
	177.7 kB	

## Manual

System Manual WAGO I/O System 750/753 Decentralized Automation Technology	V 3.3.0 2023 May 4	pdf	Download
		8.8 MB	

Product Manual 4 FAI 0/4-20 mA; Diff. PROFIsafe Fail Safe 4 Channel Analog Input Module PROFIsafe	V 1.1.0 2023 Feb 13	pdf	Download
		5.9 MB	

## Bid Text

753-668/000-004 X81 - Datei	xml	Download
	8.3 kB	

753-668/000-004 doc - Datei	doc	Download
	32.3 kB	

## Instruction Leaflet

CCC Ex (Additional information) WAGO-I/O-SYSTEM *750-****/*	2023 Apr 26	pdf	Download
		163.6 kB	

Gebrauchs- und Montageanleitung Sicherheitsklemmen PROFIsafe	V 1.0.0 2019 Nov 11	pdf	Download
		1.1 MB	

## Application Notes

## Application note SIEMENS

Using iPar-Server option with WAGO PROFIsafe modules (a114802)	V 14.1 2023 Feb 7	zip	Download
		99.8 MB	

Subject to changes. Please also observe the further product documentation!



Use of WAGO PROFIsafe modules generation 3 and generation 4 in combination under Siemens safety controllers with technologies iPar-Server and TCI.

New version recommended for use with PROFIsafe modules generation 4.

Supported surfaces TIA V15.1, V16, V17 and V18 in combination with CPU1xxF.

Step 7 Classic version available at WAGO IO-Support.

---

## Libraries

### SISTEMA library

SISTEMA-Bibliothek	2.08 2022 Jun 2	zip 204.1 kB	Download
--------------------	--------------------	-----------------	----------

---

VDMA-Bibliothek	0.0.11 2022 May 11	zip 411.7 kB	Download
-----------------	-----------------------	-----------------	----------

---

## Engineering-Software

### Configuration and Commissioning Software

Safety Editor (SEDI) / 750-66x Loadable safety editor module for parameterisable failsafe modules for integration in IO-Check from version 3.25.3 or higher.	3.5.0.0 2022 Dec 13	zip 19.5 MB	Download
---	------------------------	----------------	----------

---

## CAD/CAE-Data

### CAE data

EPLAN Data Portal 753-668/000-004		URL	Download
-----------------------------------	--	-----	----------

---

### CAD data

2D/3D Models 753-668/000-004		URL	Download
------------------------------	--	-----	----------

---

## Installation Notes

Subject to changes. Please also observe the further product documentation!

---



## Product family

WAGO I/O System 750/753

[Show all products from the family](#)

Subject to changes. Please also observe the further product documentation!

---

WAGO GmbH & Co. KG

Hansastr. 27

32423 Minden

Phone: +49571 887-0 | Fax: +49571 887-169

Email: [info.de@wago.com](mailto:info.de@wago.com) | Web: [www.wago.com](http://www.wago.com)

Do you have any questions about our products?

We are always happy to take your call at +49 (571) 887-44222.