



1200V/10A Silicon Carbide Power Schottky Barrier Diode

Features

- Rated to 1200V at 10 Amps
- Zero reverse recovery current
- Zero forward recovery voltage
- Temperature independent switching behaviour
- High temperature operation
- High frequency operation

Benefits

- Unipolar rectifier
- Substantially reduced switching losses
- No thermal run-away with parallel devices
- Reduced heat sink requirements

Applications

- SMPS, e.g., CCM PFC;
- Motor drives, Solar application, UPS, Wind turbine, Rail traction, EV/HEV

Key Characteristics		
V_{RRM}	1200	V
$I_F, T_c \leq 155^\circ\text{C}$	10	A
Q_c	54.4	nC

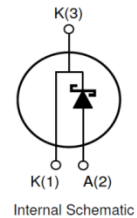
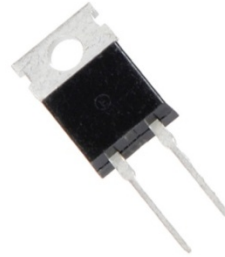

Part No.	Package Type	Marking
G3S12010A	TO-220AC	G3S12010A

Maximum Ratings

Parameter	Symbol	Test Condition	Value	Unit
Repetitive Peak Reverse Voltage	V_{RRM}		1200	V
Surge Peak Reverse Voltage	V_{RSM}		1200	V
DC Blocking Voltage	V_{DC}		1200	V
Continuous Forward Current	I_F	$T_C=25^{\circ}C$	34.8	A
		$T_C=125^{\circ}C$	19	
		$T_C=155^{\circ}C$	10	
Repetitive Peak Forward Surge Current	I_{FRM}	$T_C=25^{\circ}C$, $t_p=10ms$, Half Sine Wave, $D=0.3$	50	A
Non-repetitive Peak Forward Surge Current	I_{FSM}	$T_C=25^{\circ}C$, $t_p=10ms$, Half Sine Wave	140	A
Power Dissipation	P_{TOT}	$T_C=25^{\circ}C$	203	W
		$T_C=110^{\circ}C$	88	W
Operating Junction	T_j		$-55^{\circ}C$ to $175^{\circ}C$	$^{\circ}C$
Storage Temperature	T_{stg}		$-55^{\circ}C$ to $175^{\circ}C$	$^{\circ}C$
Mounting Torque		M3 Screw	1	Nm
		6-32 Screw	8.8	lbf-in

Thermal Characteristics

Parameter	Symbol	Test Condition	Value	Unit
			Typ.	
Thermal resistance from junction to case	$R_{th JC}$		0.74	$^{\circ}C/W$

Electrical Characteristics

Parameter	Symbol	Test Conditions	Numerical		Unit
			Typ.	Max.	
Forward Voltage	V_F	$I_F=10A, T_j=25^\circ C$	1.5	1.7	V
		$I_F=10A, T_j=175^\circ C$	2.5	3	
Reverse Current	I_R	$V_R=1200V, T_j=25^\circ C$	10	50	μA
		$V_R=1200V, T_j=175^\circ C$	20	100	
Total Capacitive Charge	Q_C	$V_R=800V, T_j=150^\circ C$ $Q_C = \int_0^{V_R} C(V)dV$	54.4	-	nC
Total Capacitance	C	$V_R=0V, T_j=25^\circ C, f=1MHz$	770	790	pF
		$V_R=400V, T_j=25^\circ C, f=1MHz$	52	54	
		$V_R=800V, T_j=25^\circ C, f=1MHz$	50	51	

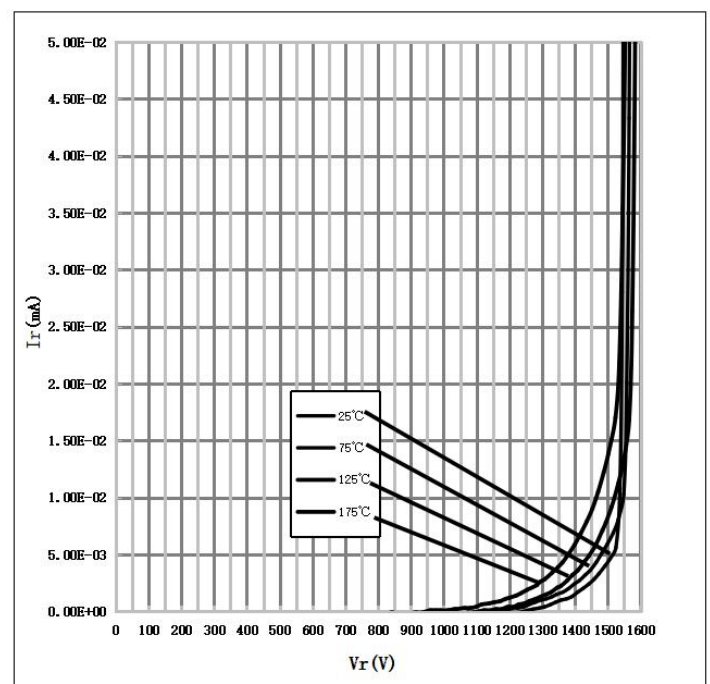
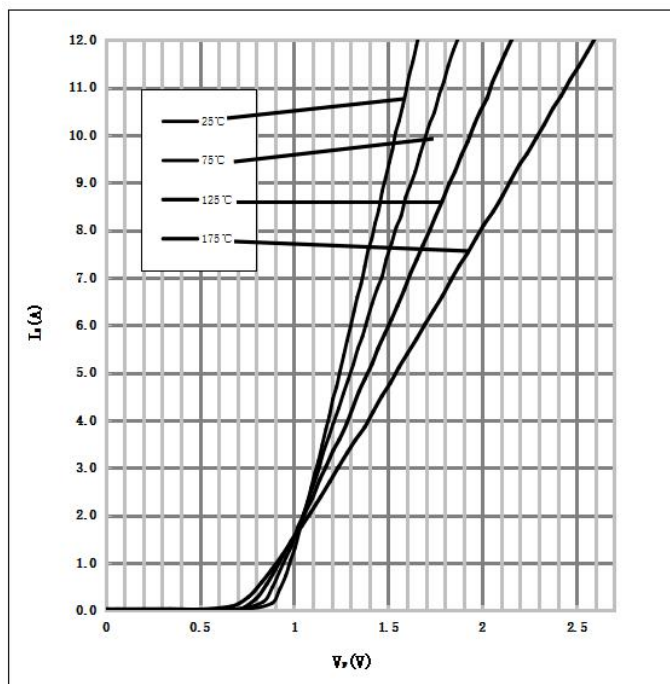
Performance Graphs1) Forward IV characteristics as a function of T_j :2) Reverse IV characteristics as a function of T_j :

3) Current Derating

4) Capacitance vs. reverse voltage :

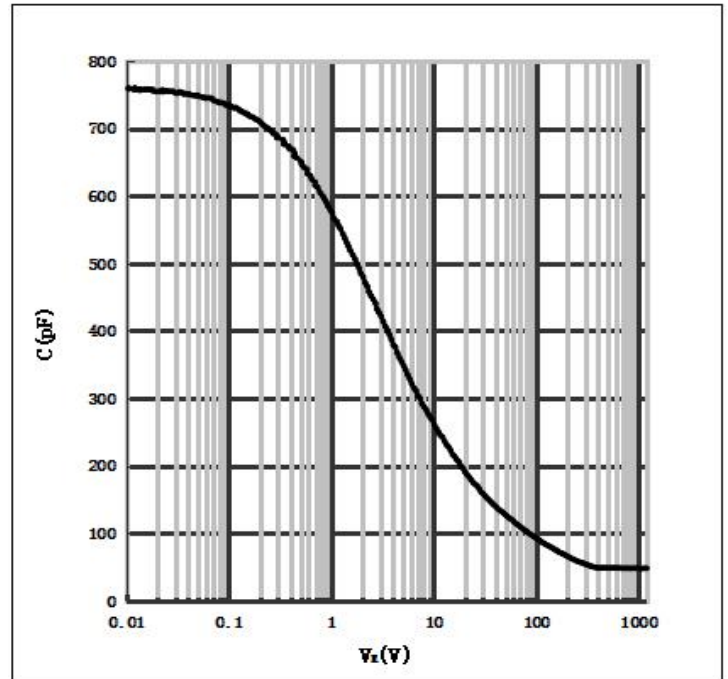
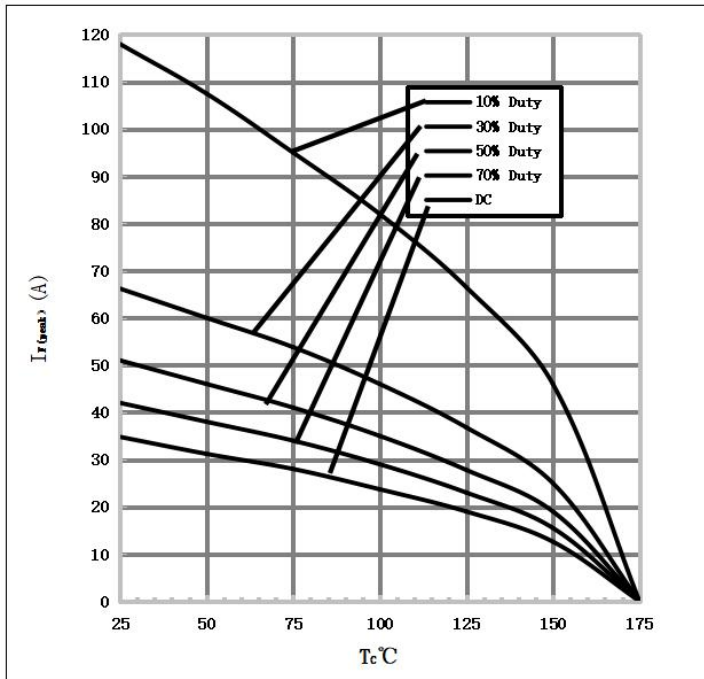

Package TO-220AC

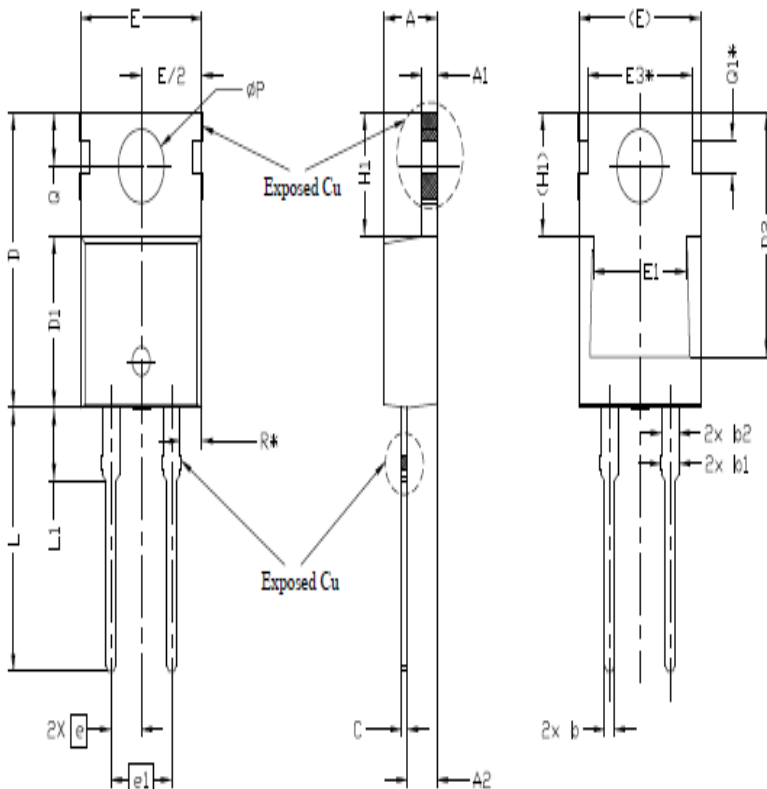

SYMBOL	DIMENSIONS			NOTES
	MIN.	NOM.	MAX.	
A	4.24	4.44	4.64	
A1	1.15	1.27	1.40	
A2	2.30	2.48	2.70	
b	0.70	0.80	0.90	
b1	1.20	1.55	1.75	
b2	1.20	1.45	1.70	
c	0.40	0.50	0.60	
D	14.70	15.37	16.00	4
D1	8.82	8.92	9.02	
D2	12.63	12.73	12.83	5
E	9.96	10.16	10.36	4,5
E1	6.86	7.77	8.89	5
E3*	8.70REF.			
e	2.54BSC			
e1	5.08BSC			
H1	6.30	6.45	6.60	5,6
L	13.47	13.72	13.97	
L1	3.60	3.80	4.00	
ϕP	3.75	3.84	3.93	
Q	2.60	2.80	3.00	
Q1*	1.73REF.			
R*	1.82REF.			

Note: The levels of RoHS restricted materials in this product are below the maximum concentration values (also referred to as the threshold limits) permitted for such substances, or are used in an exempted application, in accordance with EU Directive 2011/65/EC(RoHS2). RoHS Certification and other certifications can be obtained from GPT sales representatives or GPT website: <http://globalpowertech.cn/English/index.asp>

More product datasheets and company information can be found in:

<http://globalpowertech.cn/English/index.asp>

