

Wearable Wireless Power EVM User's Guide

TSWITX-12V-EVM



www.semtech.com

Evaluation Board User's Guide

Description

TS51231 is a transmitter driver and output stage for wireless charging applications. It can support systems up to 5W output. Switching of the TS51231 is controlled by the wireless power transmitter controller (TS80002 or similar). TS51231 Tx EVM is a transmission evaluation board for wearable application. All the necessary function components occupy a 10mmX13mm of PCB area.

The wireless power Rx board should be work together with Tx board. The maximum output power of Rx EVM is 2W at 5V.

Jumper introduction

1. Tx board is rectangle and Rx board circler;
2. J1 on Tx board is input port and J1 on Rx board output port;
3. Short J2 jumper on Rx board can light LED1 to indicate output voltage, J2 should be open when conducting efficiency testing;

Operation Instruction

1. Connect 12Vin into J1 of Tx board;
2. On Rx Board, Connect e-load to J1 between VOUT+ and GND;
3. Set the required output current (0A-400mA) with electrical loads in CC mode;
4. place Rx board onto the top of Tx board, aligning to the circular edge; In order to get the maximum output power and efficiency, Rx board must be located right above the Tx coil and the space between Tx & Rx coils should be ~4mm.

Efficiency

Evaluation Board User's Guide

efficiency Vs Load

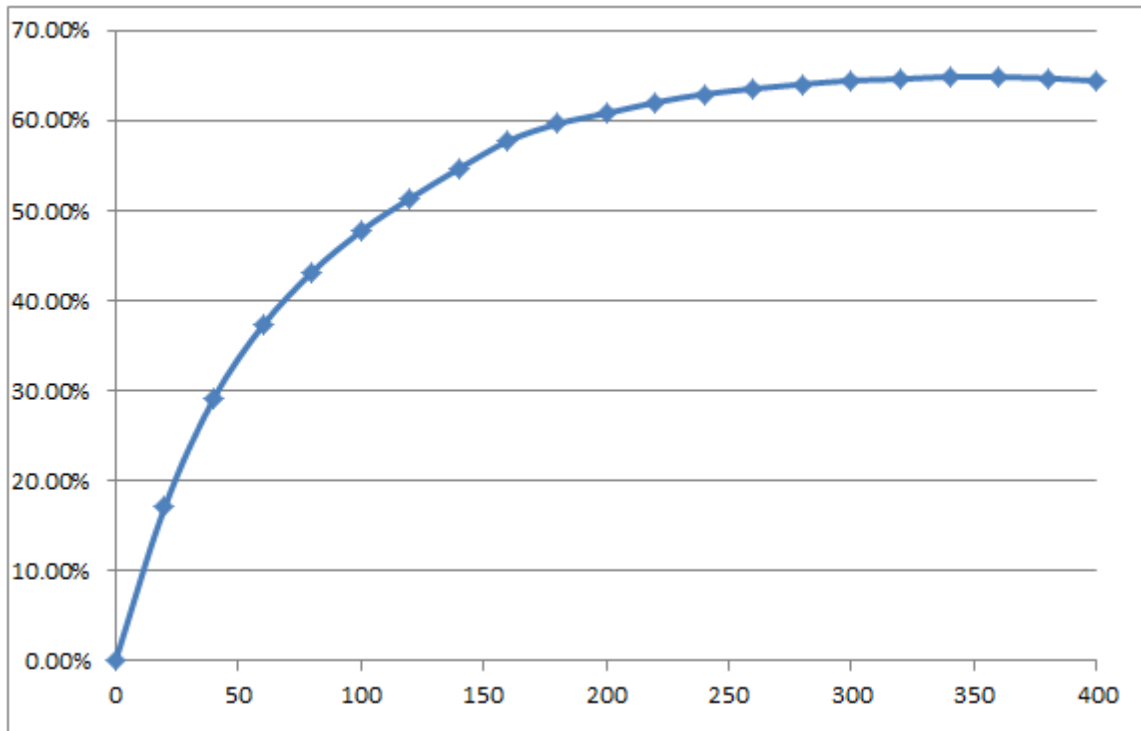

TSWIRX-5V2-EVM on TSWITX-12V-EVM

Evaluation Board User's Guide

Schematic

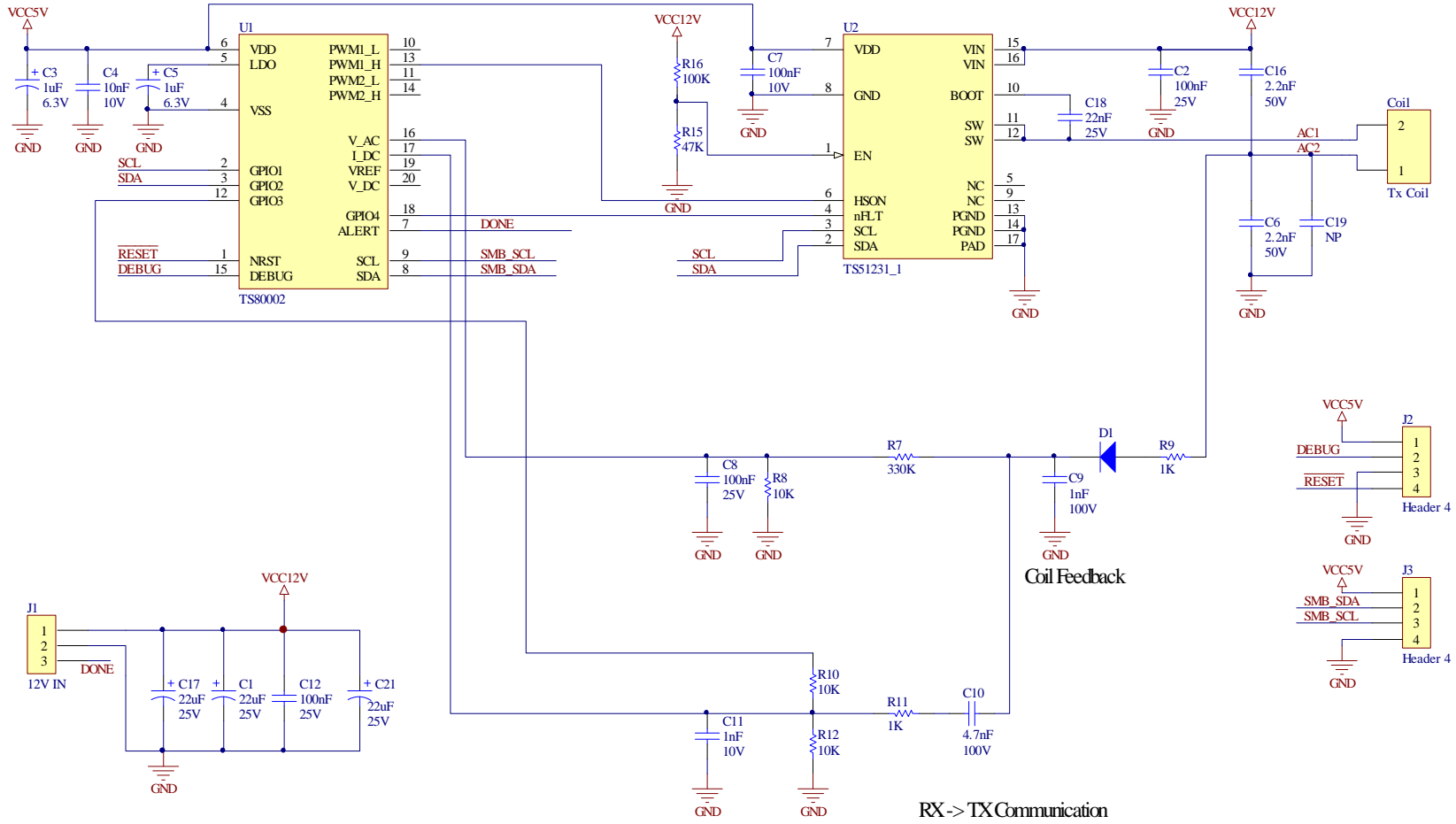

Figure 1: Schematic

Evaluation Board User's Guide

Bill of Materials

Designator	Comment	Value	Value2	Footprint	LibRef	Quantity
C1, C17, C21	Cap	22uF	25V	CAPC0805L	Cap Pol	3
C2, C12	Cap	100nF	25V	CAPC0402L	Cap	2
C3, C5	Cap	1uF	6.3V	CAPC0402L	Cap Pol	2
C4	Cap	10nF	10V	CAPC0402L	Cap	1
C6, C16	Cap C0G	2.2nF	50V	CAPC0805L	Cap	2
C7, C8	Cap	100nF	25V	CAPC0402L	Cap	2
C9	Cap X7R	1nF	100V	CAPC0603L	Cap	1
C10	Cap X7R	4.7nF	100V	CAPC0603L	Cap	1
C11	Cap	1nF	25V	CAPC0402L	Cap	1
C18	Cap	22nF	25V	CAPC0402L	Cap	1
C19	Cap C0G	NP		CAPC0603L	Cap	1
Coil	Y31-60182F, WT292965-12K2- TS			OD 29mm		1
D1	1SS400T1G	200V		SOD523-L	Diode	1
J1	12V IN			SIP3A	CON3, 2.54mm,1*3p	1
R7	Res	330K		RESC0402L	Res	1
R9	Res	1K		RESC0603L	Res	1
R11	Res	1K		RESC0402L	Res	1
R10, R12,R8	Res	10K		RESC0402L	Res	2
R15	Res	47K		RESC0402L	Res	1
R16	Res	100K		RESC0402L	Res	1
U1	TS80002			UFQFPN50P300X300-20VN	TS80002-QFN	1
U2	TS51231			QFN50P300X300-16V6-165N	TS51231	1

Evaluation Board User's Guide

EVB Layout layers

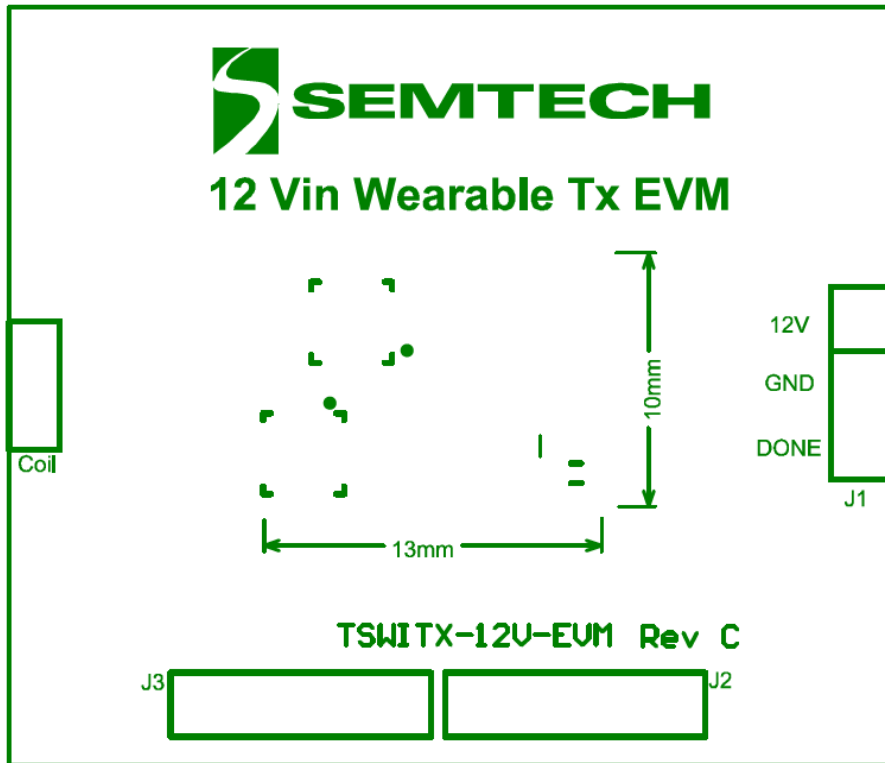

Figure 2: Silk screen top layer

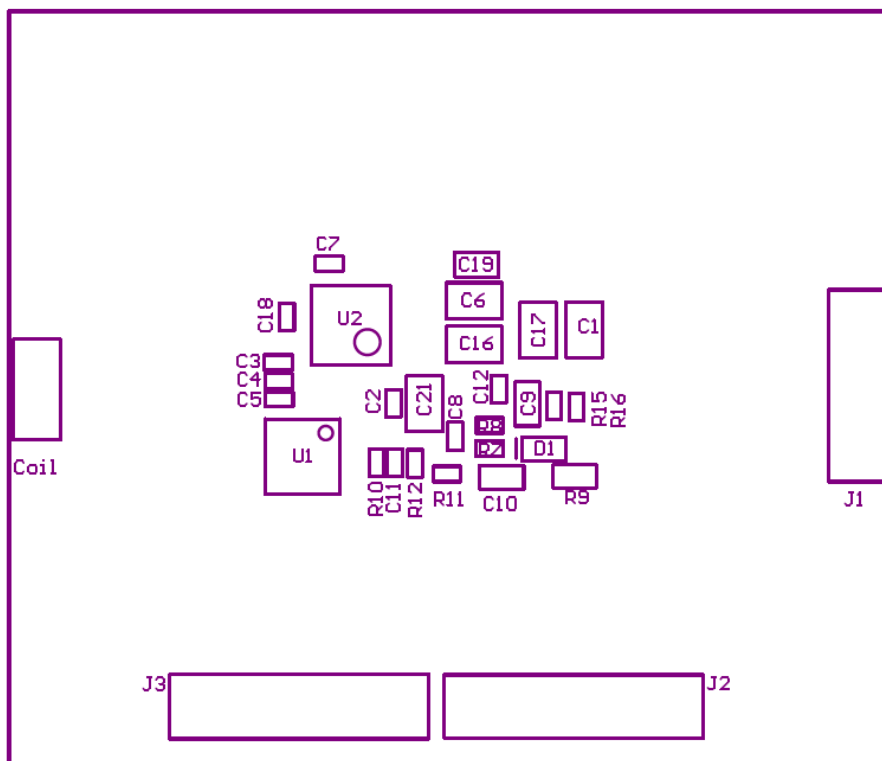

Figure 3: Mechanical13 layer

Evaluation Board User's Guide

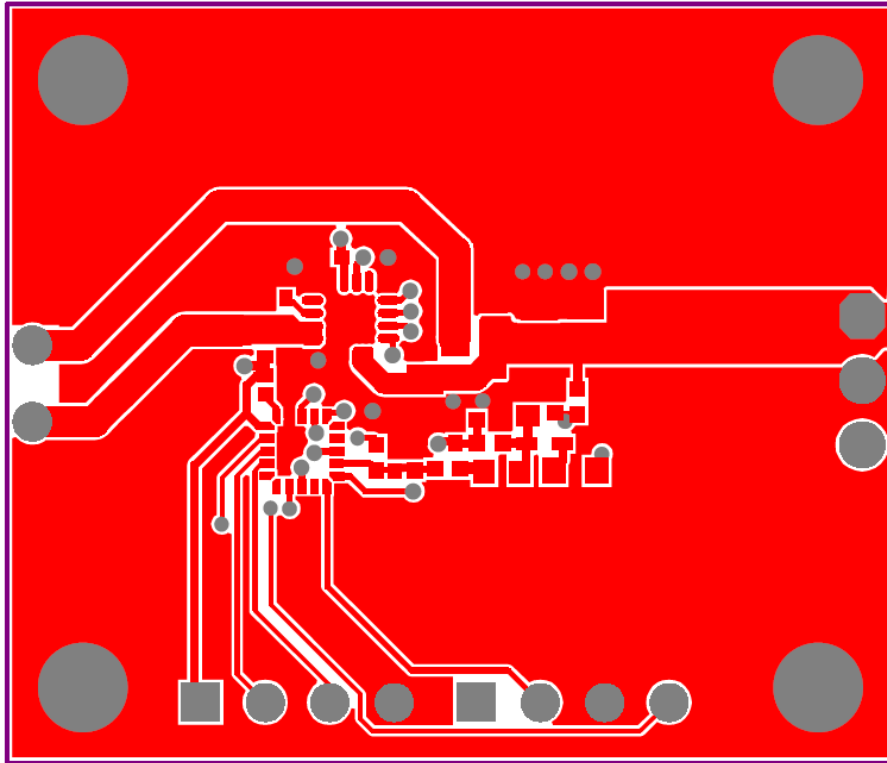

Figure 4: Top layer

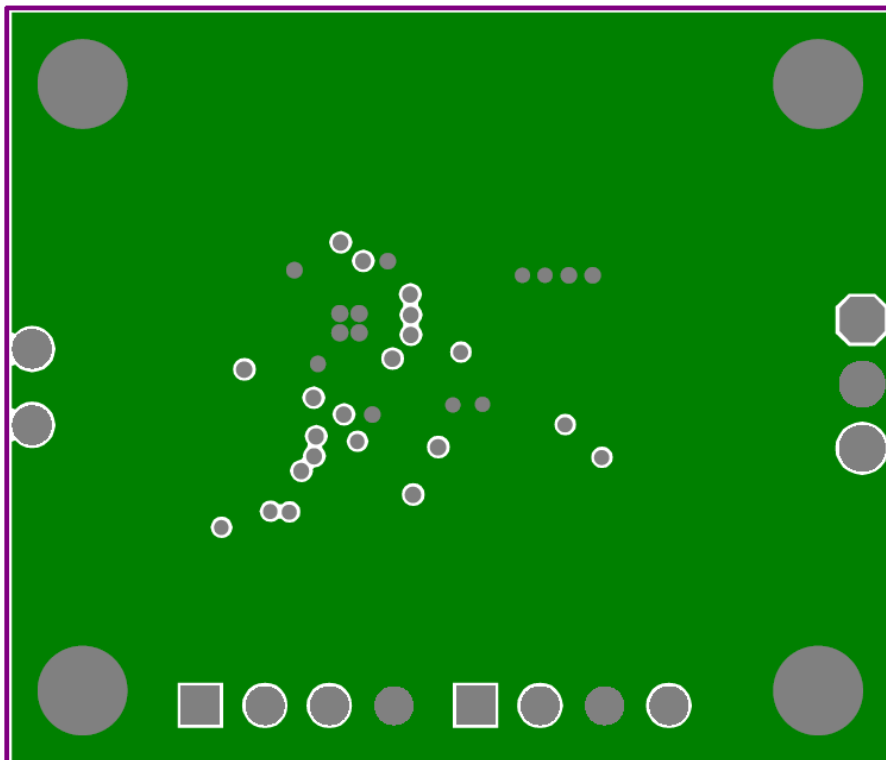

Figure 5: Ground layer

Evaluation Board User's Guide

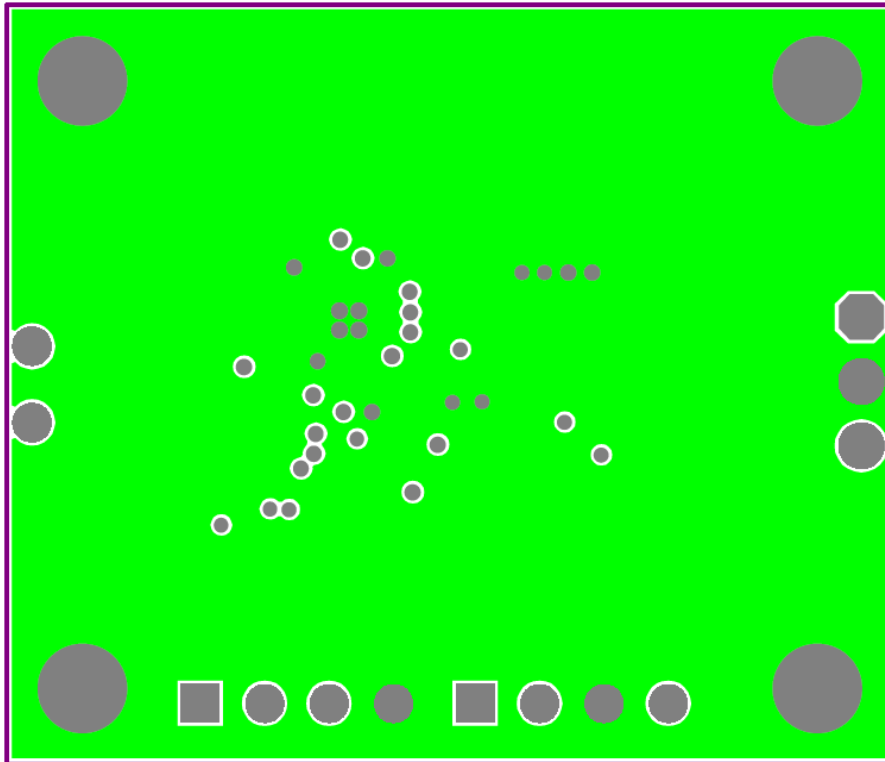

Figure 6: Signal layer

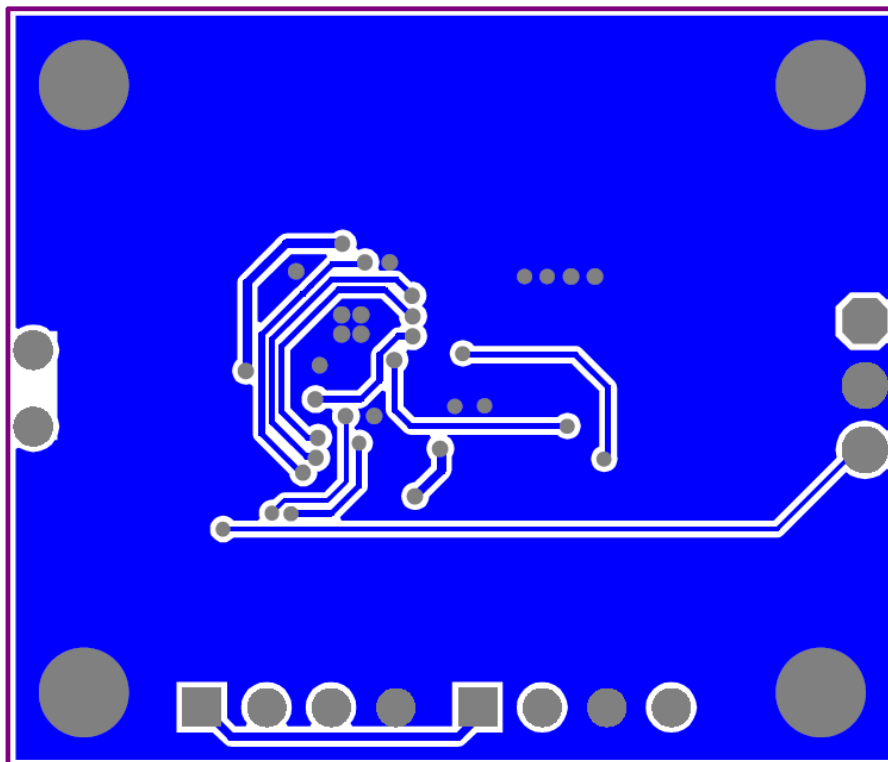

Figure 7: Bottom layer

Evaluation Board User's Guide

All Design files for this EVB are available. Please call Semtech.