

REV.	EN. NO.	DESCRIPTION	SIGN	DATE
C1	N/A	INITIAL DRAWING	Hary	2020/05/04

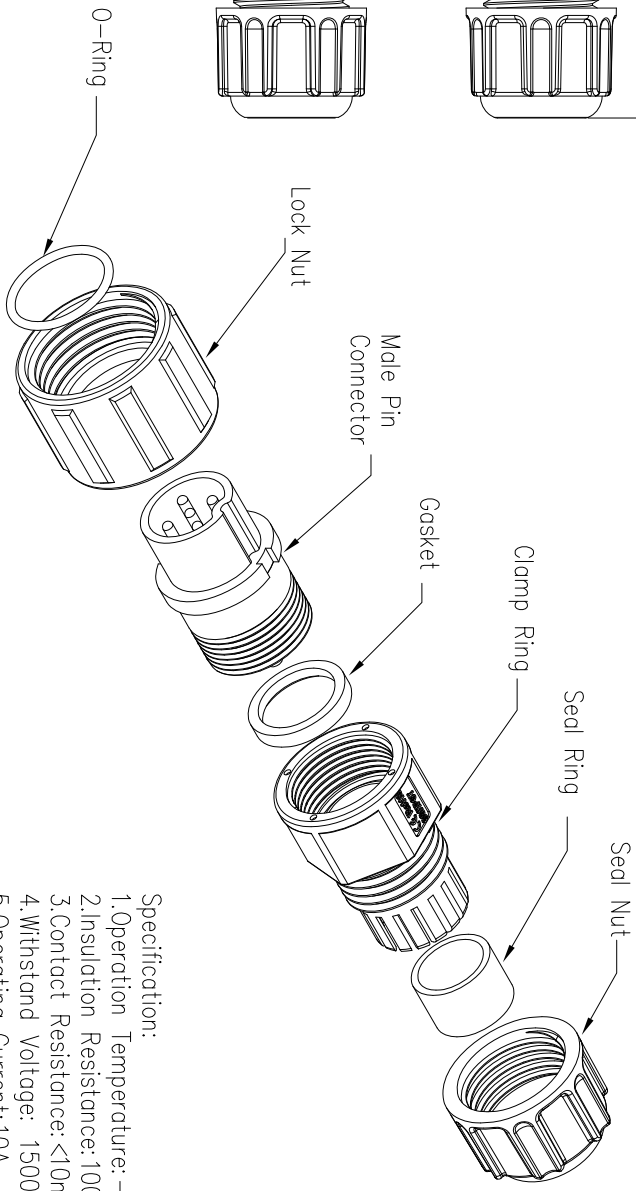

23XXX111-XX Cable Range OD
 01 OD: $\phi 3.5\text{mm} \sim \phi 6.5\text{mm}$
 02 OD: $\phi 6.5\text{mm} \sim \phi 9.5\text{mm}$

Pin Number

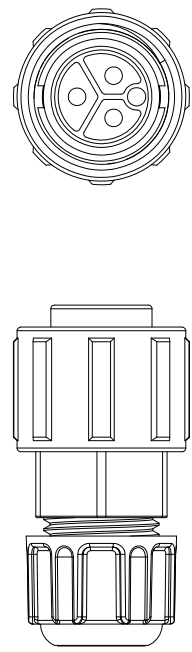
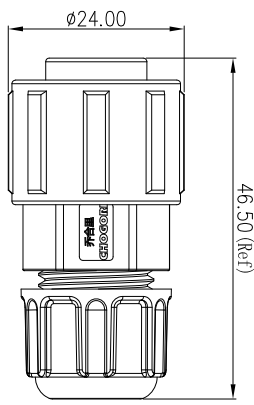
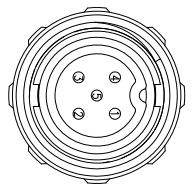

5 Pin

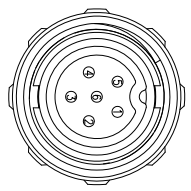

6 Pin

P/N: 23005111-XX P/N: 23006111-XX

Pin Assignments Front View

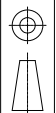

UNIT: mm
 TOLERANCE
 .X ±0.25
 .XX ±0.15
 .XXX ±0.05
 ANGLES ±1°

DESCRIPTION

Middle Series Screw
 Male Plug With Male Pin

SCALE: 1:1
 REV: C1 SIZE: A4
 SHEET: 1 OF 1
 * : Inspection Item

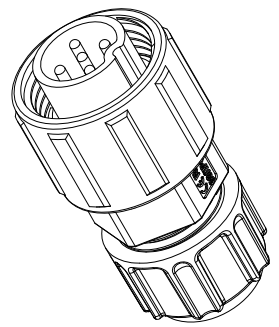

Specification:

1. Operation Temperature: $-45^{\circ}\text{C} \sim 105^{\circ}\text{C}$.
2. Insulation Resistance: $100\text{M}\Omega$ at DC500V.
3. Contact Resistance: $<10\text{m}\Omega$.
4. Withstand Voltage: 1500V AC
5. Operating Current: 10A
6. Operating Voltage: AC 125V
7. Waterproof Rate: IP67 (Mated)
8. Seal Nut: Nylon, Black
9. Seal Ring: Silicon, Black
10. Clamp Ring: Nylon, Black
11. Gasket: Silicon, Red
12. Lock Nut: Nylon, Black
13. Male Pin: Copper Alloy, Gold Plated
14. Connector: Nylon+GF, Black
15. O-Ring: Silicon, Red
16. RoHS Compliant.
17. UL Compliant.
18. Mating Cap: 806-00026-01

CHOGORI

PART NO	DRAWN BY	DATE
23XXX111-XX	Hary	2020/05/04
DWG NO	CHECKED BY	DATE
	MO	2020/05/04
CUSTOMER	APPROVED BY	DATE
	Panson	2020/05/04