

TOLERANCE
UNLESS OTHERWISE
SPECIFIED

.X	±0.35
.XX	±0.25
.XXX	±0.15

THIS IS A C.A.D. GENERATED DRAWING
DO NOT MAKE MANUAL REVISIONS TO MASTER.



ISSUE NUMBER

ORIGINAL

1

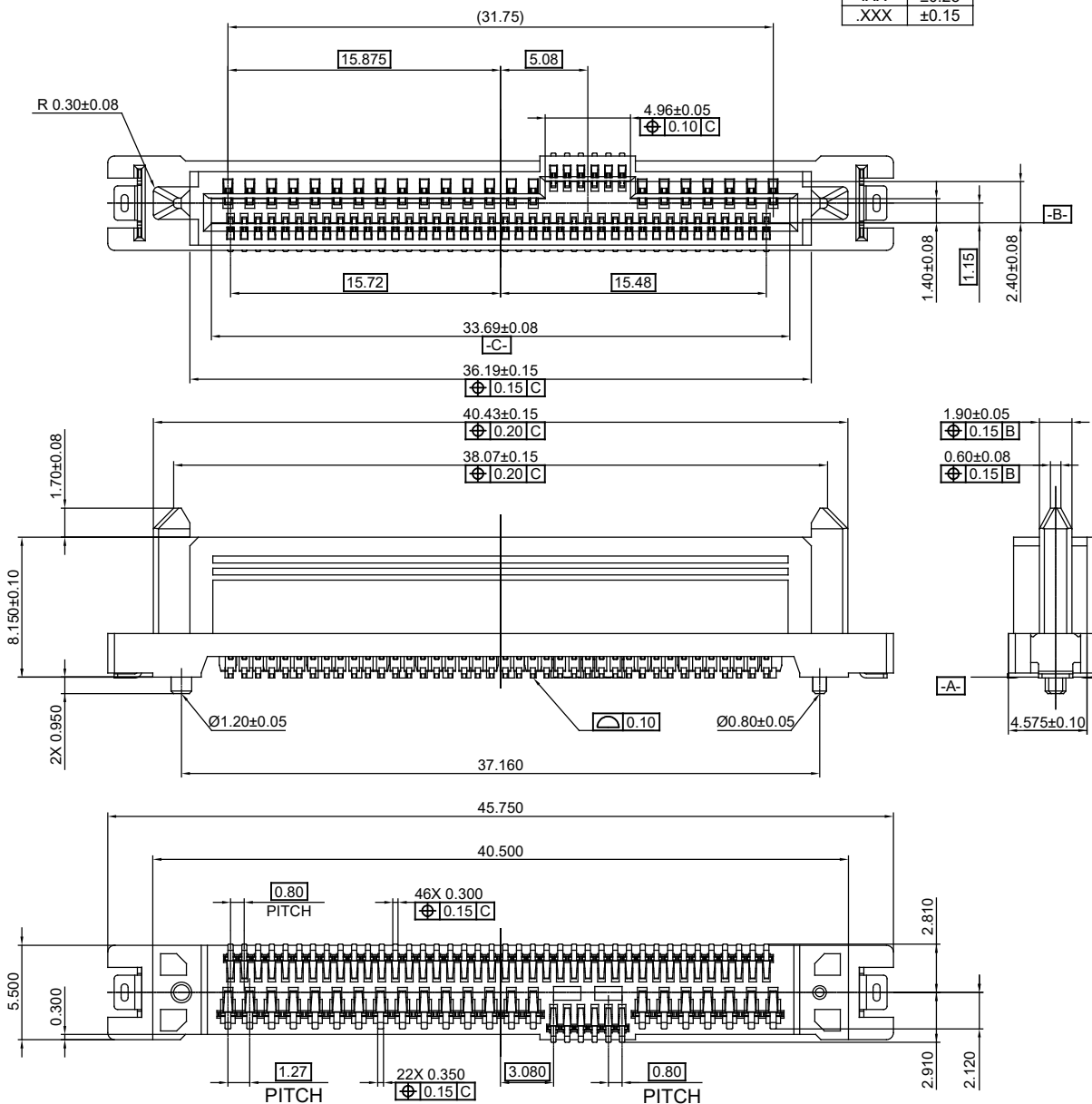

NOTES:

MATERIAL:
HOUSING:
CONTACT:

L.C.P GLASS FILLED, UL-94V-0
COPPER ALLOY, 30µ" GOLD PLATING ON CONTACT AREA
MATTE TIN PLATING ON SOLDER TAIL OVER 50µ" MIN.
NICKEL UNDER PLATING

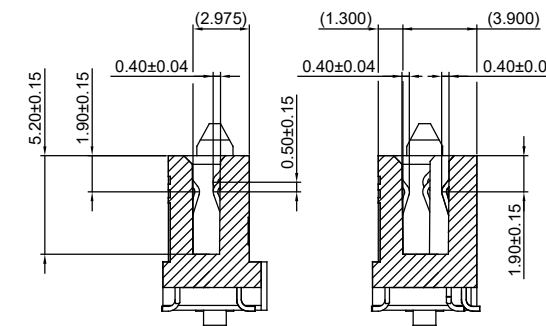

NO.	DESCRIPTION	QTY.	MATERIAL	FINISH/COLOR
MOVE	LATCH	2	COPPER ALLOY	TIN 100~200 µ"
4	PITCH 0.80 CONTACT	46	COPPER ALLOY	SEE NOTES
3	PITCH 1.27 CONTACT	22	COPPER ALLOY	SEE NOTES
2	CAP	1	GLASS FILLED LCP, UL94 V-0	BLACK
1	HOUSING	1	GLASS FILLED LCP, UL94 V-0	BLACK

SAS CONNECTOR, VERTICAL SMT,
68 CONTACTS, FEMALE

ACAD REFERENCE NO.: 271-068-629-002

DRAWN: W.T DATE: JULY.03 /2018

CHECKED: DATE:

SCALE: N.T.S SHEET 1 OF 2

DRAWING NUMBER: 271-068-629-002

ISSUE

PART NUMBER: 271-068-629-002

1



THIS SERIES FULLY CONFORMS TO
THE EUROPEAN UNION DIRECTIVES
2011/65/EU FOR RoHS COMPLIANCE.



EDAC INC
TORONTO, ONTARIO
CANADA

YOUR CONNECTION TO QUALITY & SERVICE

THESE DRAWINGS AND SPECIFICATIONS
ARE THE PROPERTY OF EDAC INC., AND
SHALL NOT BE REPRODUCED, OR COPIED
OR USED AS THE BASIS FOR THE
MANUFACTURE OR SALE OF APPARATUS
WITHOUT WRITTEN PERMISSION.

TOLERANCE
UNLESS OTHERWISE
SPECIFIED

.X	±0.35
.XX	±0.25
.XXX	±0.15

THIS IS A C.A.D. GENERATED DRAWING
DO NOT MAKE MANUAL REVISIONS TO MASTER.



ISSUE NUMBER

ORIGINAL

1

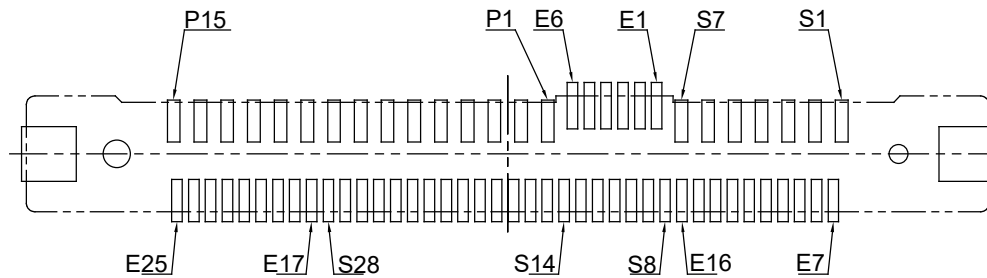
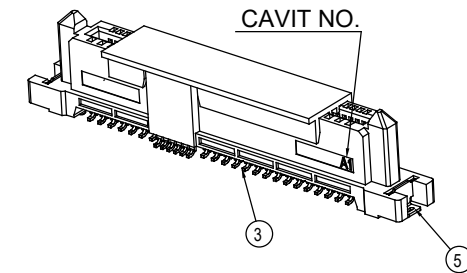
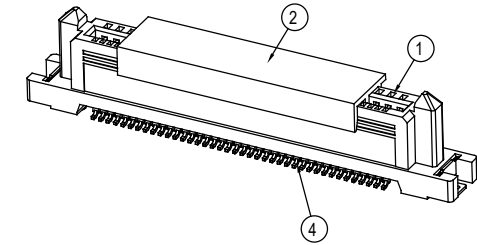
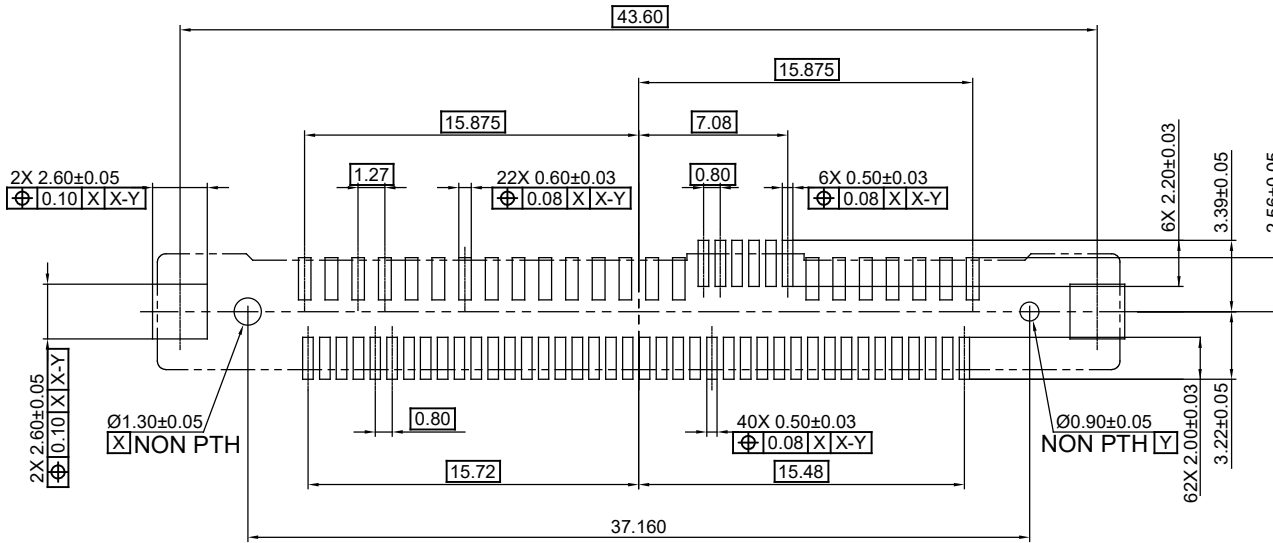

DATE CODE: 16 17
WEEK
YEAR: 2016

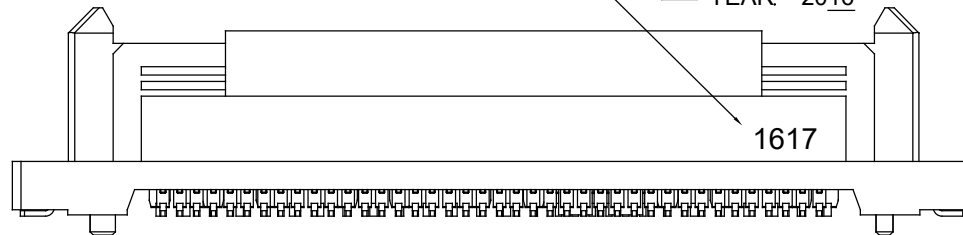

NO.	DESCRIPTION	QTY.	MATERIAL	FINISH/COLOR
MOVE	LATCH	2	COPPER ALLOY	TIN 100~200 µ"
4	PITCH 0.80 CONTACT	46	COPPER ALLOY	SEE NOTES
3	PITCH 1.27 CONTACT	22	COPPER ALLOY	SEE NOTES
2	CAP	1	GLASS FILLED LCP, UL94 V-0	BLACK
1	HOUSING	1	GLASS FILLED LCP, UL94 V-0	BLACK

SAS CONNECTOR, VERTICAL SMT,
68 CONTACTS, FEMALE

ACAD REFERENCE NO.: 271-068-629-002

DRAWN: W.T

DATE: JULY.03 /2018

CHECKED:

DATE:

SCALE: N.T.S

SHEET 2 OF 2

DRAWING NUMBER: 271-068-629-002

ISSUE

PART NUMBER: 271-068-629-002

1



THIS SERIES FULLY CONFORMS TO
THE EUROPEAN UNION DIRECTIVES
2011/65/EU FOR RoHS COMPLIANCY.



YOUR CONNECTION TO QUALITY & SERVICE

EDAC INC
TORONTO, ONTARIO
CANADA

THESE DRAWINGS AND SPECIFICATIONS
ARE THE PROPERTY OF EDAC INC., AND
SHALL NOT BE REPRODUCED, OR COPIED
OR USED AS THE BASIS FOR THE
MANUFACTURE OR SALE OF APPARATUS
WITHOUT WRITTEN PERMISSION.