

Mounting Option

.128 (3.25) Dia. Side Mounting Holes

Contact Detail

90 Degree Bend (Code 521 Contacts)

.156 [3.96] Contact Spacing x .200 [5.08] Row Spacing

THIS IS A C.A.D. GENERATED DRAWING
DO NOT MAKE MANUAL REVISIONS TO MASTER.



ISSUE NUMBER

ORIGINAL

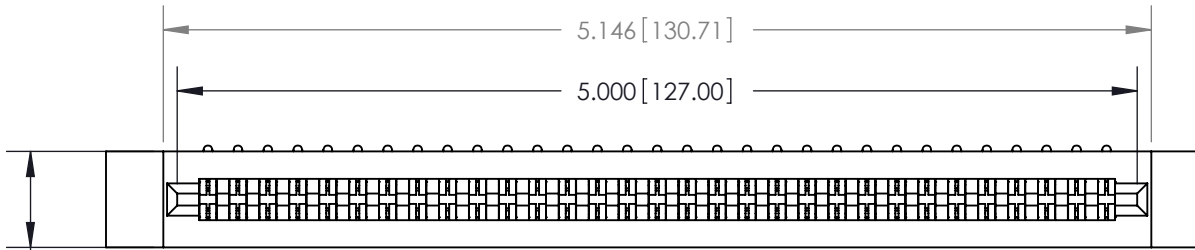

0.500 [12.70]

0.473 [12.01]

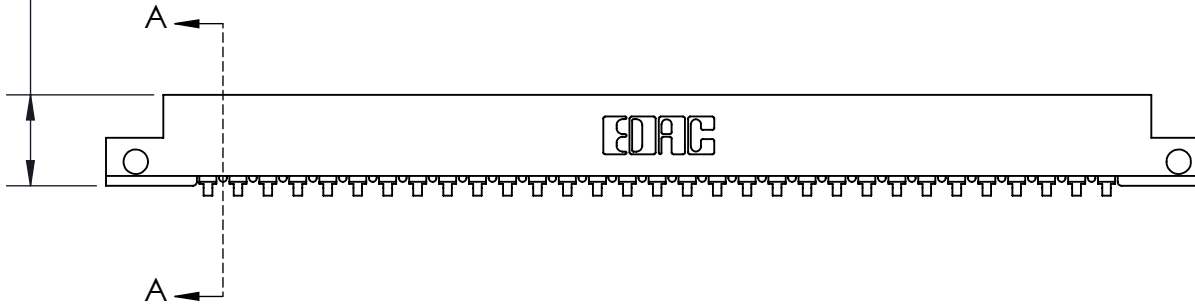

SECTION A-A

.175 [4.45] Point of Contact
(Measured from bottom of Card Slot)

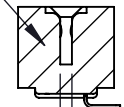

Card Slot Accepts .054 [1.37]
to .070 [1.78] Thick P.C. Board

See Accompanying Page for:

- Contact Bend Details

807/857 Series High Temp Card Edge Connector

Part Number: 857-031-553-112



EDAC INC
TORONTO, ONTARIO
CANADA

YOUR CONNECTION TO QUALITY & SERVICE

THESE DRAWINGS AND SPECIFICATIONS
ARE THE PROPERTY OF EDAC INC. AND
SHALL NOT BE REPRODUCED, OR COPIED
OR USED AS THE BASIS FOR THE
MANUFACTURE OR SALE OF APPARATUS
WITHOUT WRITTEN PERMISSION.

ACAD REFERENCE NO. 807 ENG MASTER

DRAWN: J.LEE DATE: AUG. 11/09

CHECKED: DATE:

SCALE: NTS SHEET 1 OF 2

DRAWING NUMBER 807 Assembly ISSUE 1

Single Row Contacts - Read One Side of Daughter Board

THIS IS A C.A.D. GENERATED DRAWING
DO NOT MAKE MANUAL REVISIONS TO MASTER.



ISSUE NUMBER
ORIGINAL 1

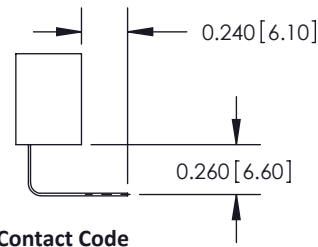

558 Contact Code

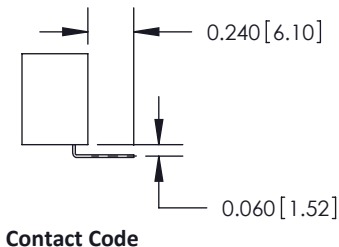

559 Contact Code

Single Row Contacts - Read Both Sides of Daughter Board

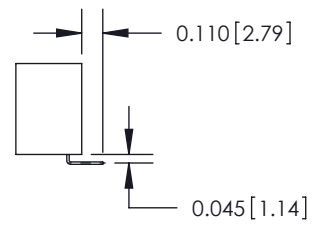

553 Contact Code

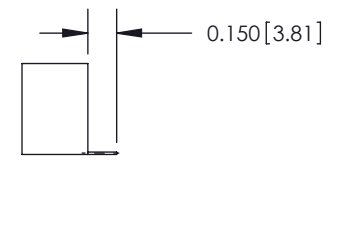

554 Contact Code

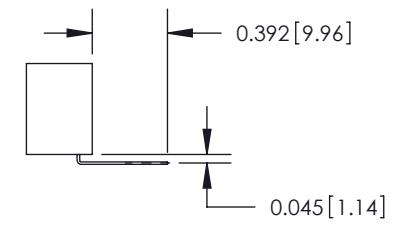

557 Contact Code

Dual Row Contacts - Read Both Sides of Daughter Board

0.240 [6.10] Up to 27/54 Pin
0.162 [4.11] 28/56 and Over

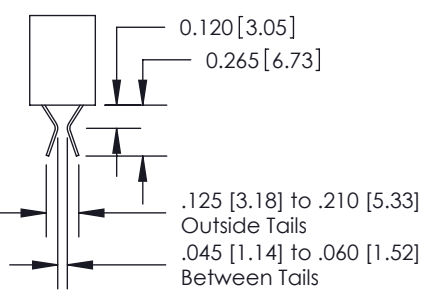

555 Contact Code

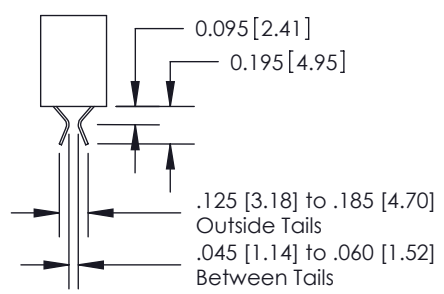

556 Contact Code

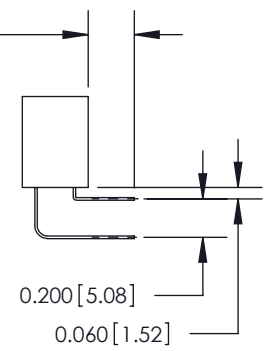

558 Contact Code

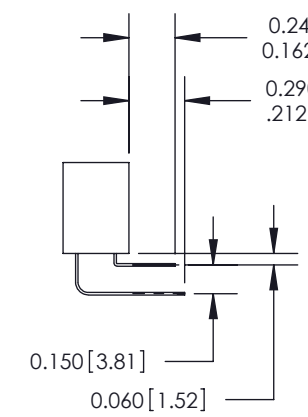

559 Contact Code

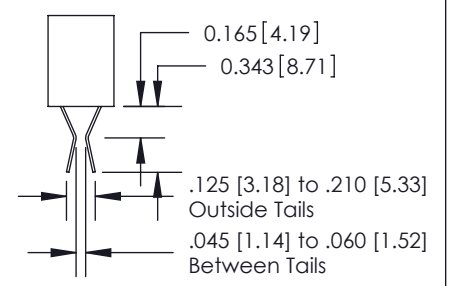

560 Contact Code

<p>807 Series High Temp Card Edge Connector Contact Bend Detail</p>		ACAD REFERENCE NO. 807 ENG MASTER	
		DRAWN: J.LEE	DATE: AUG. 11/09
 <p>EDAC INC TORONTO, ONTARIO CANADA YOUR CONNECTION TO QUALITY & SERVICE</p>		CHECKED:	DATE:
		SCALE: NTS	SHEET 2 OF 2
DRAWING NUMBER 807 Assembly			ISSUE 1

THESE DRAWINGS AND SPECIFICATIONS ARE THE PROPERTY OF EDAC INC. AND SHALL NOT BE REPRODUCED, OR COPIED OR USED AS THE BASIS FOR THE MANUFACTURE OR SALE OF APPARATUS WITHOUT WRITTEN PERMISSION.