

YASMEEN-70-S-C

~15° spot beam. Assembly with holder C compatible with LEDiL HEKLA. Black version.

SPECIFICATION:

Dimensions	Ø 69.9 mm
Height	39.9 mm
ROHS compliant	yes ⓘ

MATERIALS:

Component	Type	Material	Colour	Finish
YASMEEN-70-S	Single lens	PMMA	clear	
YASMEEN-70-HLD-C	Holder C	PC	black	

ORDERING INFORMATION:





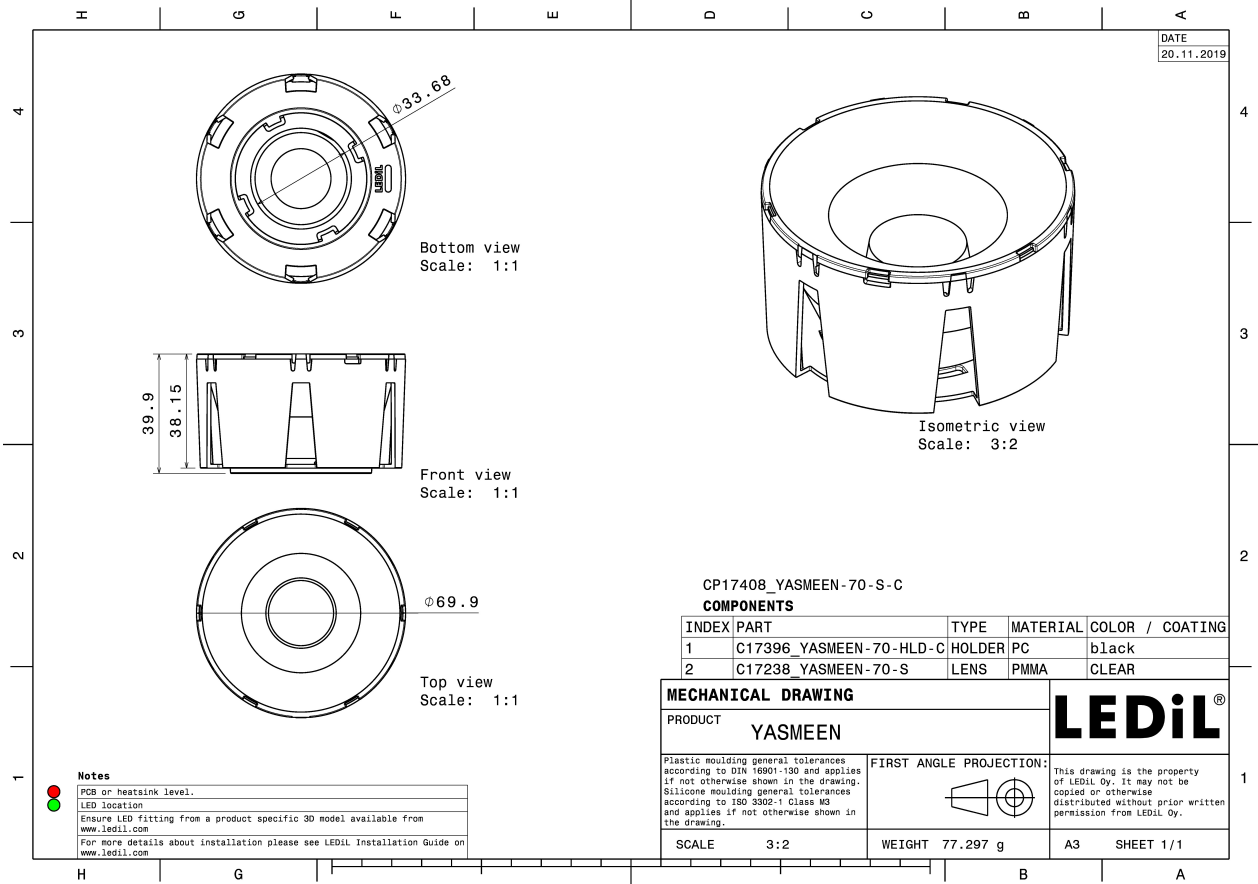

Component		Qty in box	MOQ	MPQ	Box weight (kg)
CP17408_YASMEEN-70-S-C	Single lens	105	105	15	9.8
» Box size: 476 x 273 x 305 mm					



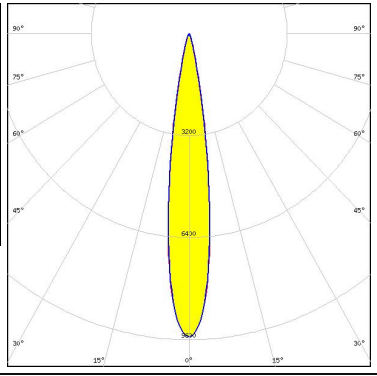

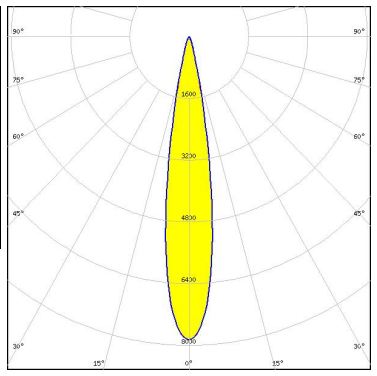

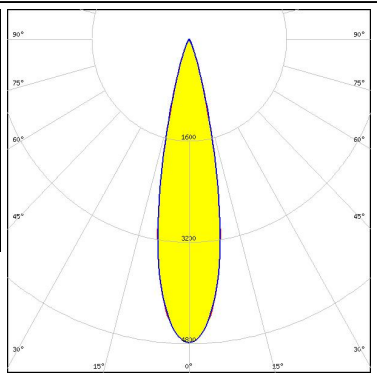

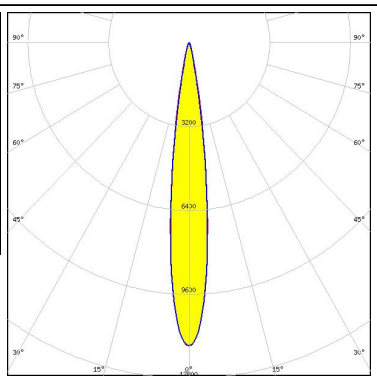



See also our general installation guide: www.ledil.com/installation_guide

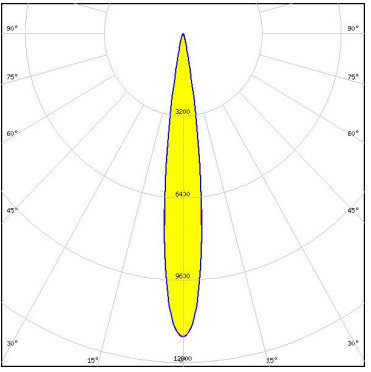

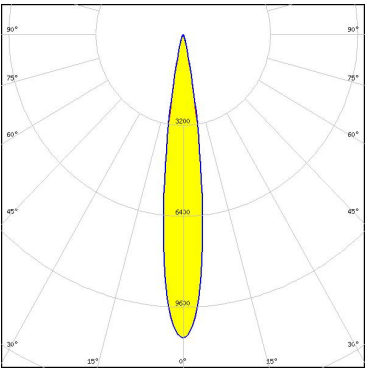

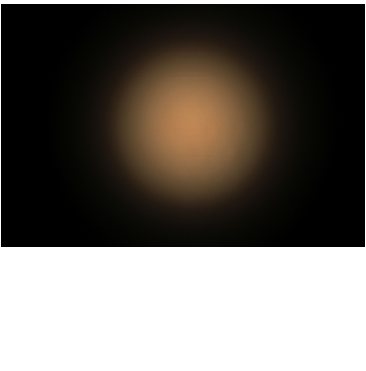
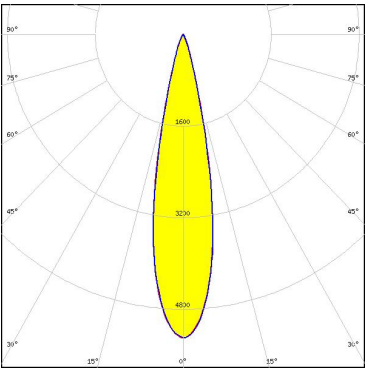

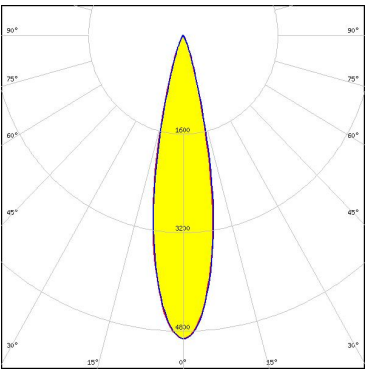
OPTICAL RESULTS (MEASURED):

<p>bridgelux.</p> <p>LED V10 Gen 8</p> <p>FWHM / FWTM 16.0° / 27.0°</p> <p>Efficiency 88 %</p> <p>Peak intensity 9.5 cd/lm</p> <p>LEDs/each optic 1</p> <p>Light colour White</p> <p>Required components: F15255_HEKLA-SOCKET-C</p>		
<p>bridgelux.</p> <p>LED V11 HD Gen 8</p> <p>FWHM / FWTM 18.0° / 30.0°</p> <p>Efficiency 87 %</p> <p>Peak intensity 7.9 cd/lm</p> <p>LEDs/each optic 1</p> <p>Light colour White</p> <p>Required components: Bender Wirth: 633d Hekla</p>		
<p>bridgelux.</p> <p>LED V13 Gen 8</p> <p>FWHM / FWTM 23.0° / 39.0°</p> <p>Efficiency 86 %</p> <p>Peak intensity 4.8 cd/lm</p> <p>LEDs/each optic 1</p> <p>Light colour White</p> <p>Required components: F15859_HEKLA-SOCKET-I</p>		
<p>bridgelux.</p> <p>LED V8 Gen 8</p> <p>FWHM / FWTM 14.0° / 25.0°</p> <p>Efficiency 90 %</p> <p>Peak intensity 11.6 cd/lm</p> <p>LEDs/each optic 1</p> <p>Light colour White</p> <p>Required components: F15253_HEKLA-SOCKET-A</p>		



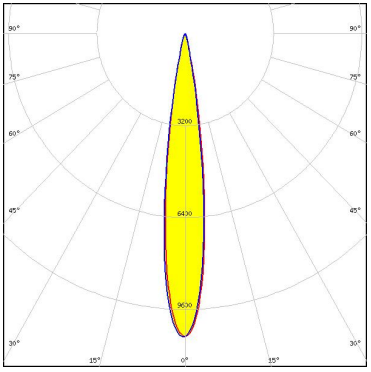
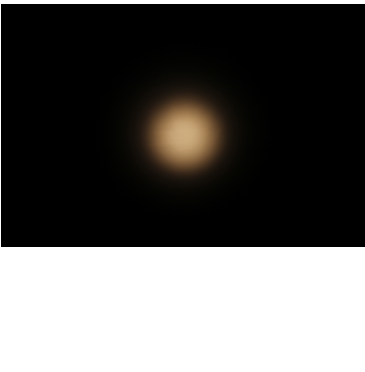
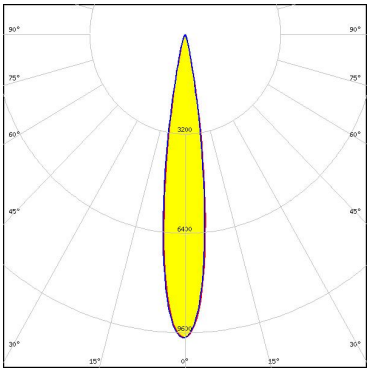

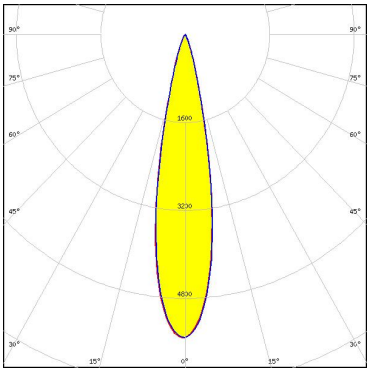

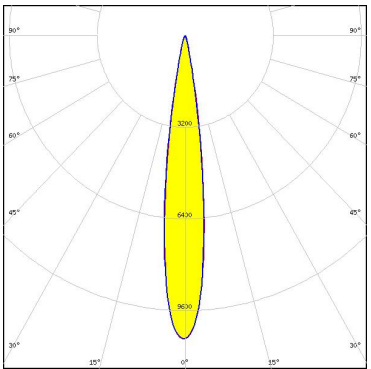
OPTICAL RESULTS (MEASURED):

<p></p> <p>LED V9 HD Gen7 FWHM / FWTM 14.0° / 24.0° Efficiency 87 % Peak intensity 11.8 cd/lm LEDs/each optic 1 Light colour White Required components: F15859_HEKLA-SOCKET-I</p>		
<p></p> <p>LED VERO10 FWHM / FWTM 14.0° / 25.0° Efficiency 88 % Peak intensity 10.7 cd/lm LEDs/each optic 1 Light colour White Required components: F15616_HEKLA-SOCKET-F</p>		
<p></p> <p>LED Vesta DTW 13mm (21W) FWHM / FWTM 22.0° / 37.0° Efficiency 86 % Peak intensity 5.3 cd/lm LEDs/each optic 1 Light colour Tunable White Required components: Bender Wirth: 632b Hekla XL</p>		
<p></p> <p>LED Vesta DTW 15mm (33W) FWHM / FWTM 23.0° / 39.0° Efficiency 86 % Peak intensity 4.9 cd/lm LEDs/each optic 1 Light colour Tunable White Required components: Bender Wirth: 632b Hekla XL</p>		

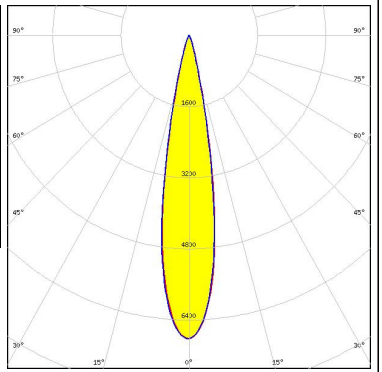

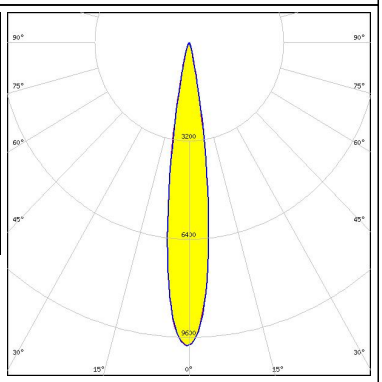
OPTICAL RESULTS (MEASURED):

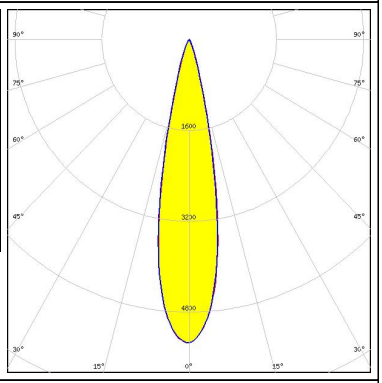
<p></p> <p>LED Vesta DTW 9mm (4W/6W/12W) FWHM / FWTM 15.0° / 26.0° Efficiency 88 % Peak intensity 10.6 cd/lm LEDs/each optic 1 Light colour Tunable White Required components: Bender Wirth: 652b Hekla</p>		
<p>CITIZEN</p> <p>LED CLL02x/CLU02x (LES10) FWHM / FWTM 15.0° / 27.0° Efficiency 87 % Peak intensity 9.8 cd/lm LEDs/each optic 1 Light colour White Required components: F17435_HEKLA-G2-C</p>		
<p>CITIZEN</p> <p>LED CLL03x/CLU03x FWHM / FWTM 21.0° / 36.5° Efficiency 85 % Peak intensity 5.5 cd/lm LEDs/each optic 1 Light colour White Required components: F17438_HEKLA-G2-I</p>		
<p></p> <p>LED CMA1516 FWHM / FWTM 14.0° / 25.0° Efficiency 87 % Peak intensity 10.6 cd/lm LEDs/each optic 1 Light colour White Required components: F17436_HEKLA-G2-D</p>		

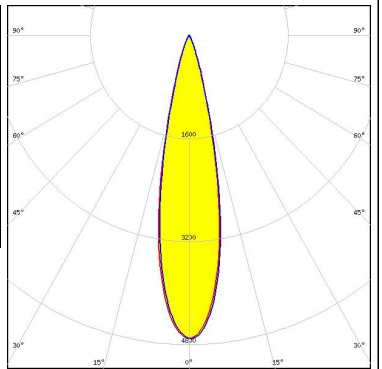
OPTICAL RESULTS (MEASURED):

<p>CREE ⇄ LED</p> <p>LED CMA1825 FWHM / FWTM 19.0° / 32.0° Efficiency 87 % Peak intensity 6.8 cd/m LEDs/each optic 1 Light colour White Required components: F15254_HEKLA-SOCKET-B</p>		
<p>CREE ⇄ LED</p> <p>LED CMT14xx FWHM / FWTM 15.0° / 26.0° Efficiency 86 % Peak intensity 9.9 cd/m LEDs/each optic 1 Light colour White Required components: F17435_HEKLA-G2-C</p>		
<p>CREE ⇄ LED</p> <p>LED CMT19xx FWHM / FWTM 21.0° / 36.0° Efficiency 85 % Peak intensity 5.3 cd/m LEDs/each optic 1 Light colour White Required components: F17438_HEKLA-G2-I</p>		
<p>CREE ⇄ LED</p> <p>LED CMU15xx FWHM / FWTM 23.0° / 39.0° Efficiency 84 % Peak intensity 4.7 cd/m LEDs/each optic 1 Light colour White Required components: F17438_HEKLA-G2-I</p>		

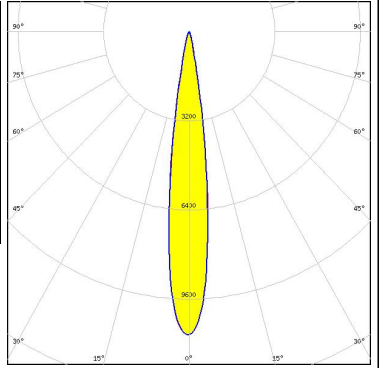
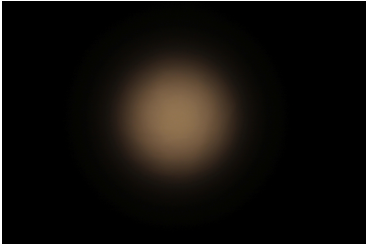
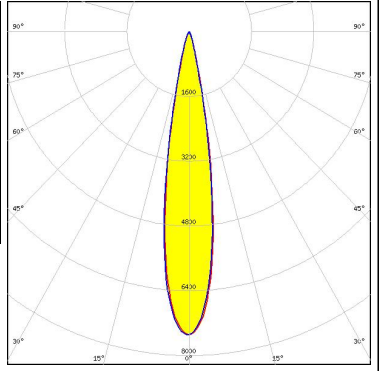
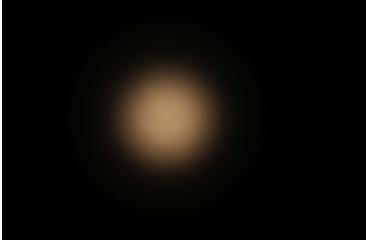
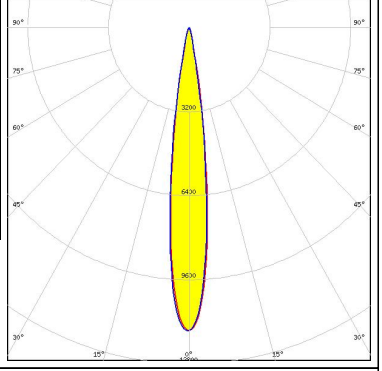
OPTICAL RESULTS (MEASURED):

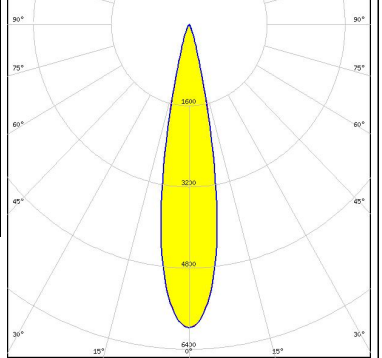
<p>LUMILEDS</p> <p>LED LUXEON CoB 1202/1203</p> <p>FWHM / FWTM 14.0° / 24.0°</p> <p>Efficiency 86 %</p> <p>Peak intensity 10.9 cd/lm</p> <p>LEDs/each optic 1</p> <p>Light colour White</p> <p>Required components: F17437_HEKLA-G2-H</p>		
<p>NICHIA</p> <p>LED COB L-Type (LES 11)</p> <p>FWHM / FWTM 17.0° / 30.0°</p> <p>Efficiency 86 %</p> <p>Peak intensity 7.5 cd/lm</p> <p>LEDs/each optic 1</p> <p>Light colour White</p> <p>Required components: F17437_HEKLA-G2-H</p>		
<p>NICHIA</p> <p>LED COB L-Type (LES 9)</p> <p>FWHM / FWTM 13.0° / 24.0°</p> <p>Efficiency 86 %</p> <p>Peak intensity 11.5 cd/lm</p> <p>LEDs/each optic 1</p> <p>Light colour White</p> <p>Required components: F17437_HEKLA-G2-H</p>		
<p>NICHIA</p> <p>LED COB S-Type (LES 7)</p> <p>FWHM / FWTM 20.0° / 34.0°</p> <p>Efficiency 85 %</p> <p>Peak intensity 6 cd/lm</p> <p>LEDs/each optic 1</p> <p>Light colour White</p> <p>Required components: F17438_HEKLA-G2-I</p>		

OPTICAL RESULTS (MEASURED):

PHILIPS

LED Fortimo SLM L09 CoB
 FWHM / FWTM 14.0° / 25.0°
 Efficiency 86 %
 Peak intensity 10.8 cd/lm
 LEDs/each optic 1
 Light colour White
 Required components:
 F17437_HEKLA-G2-H

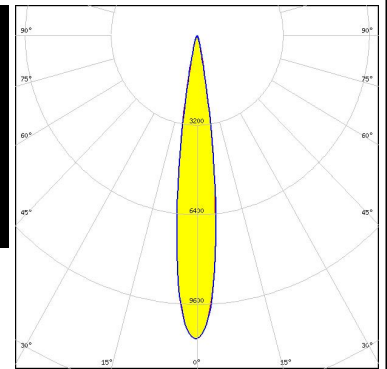

SAMSUNG

LED LC016D / LC019D / LC026D / LC033D
 FWHM / FWTM 23.0° / 39.0°
 Efficiency 85 %
 Peak intensity 4.7 cd/lm
 LEDs/each optic 1
 Light colour White
 Required components:
 F17438_HEKLA-G2-I

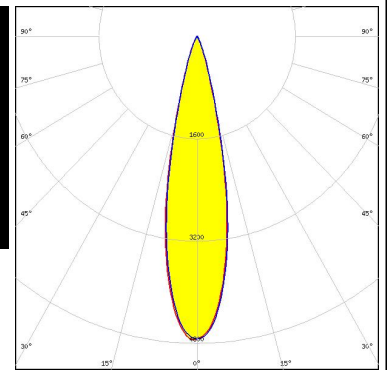
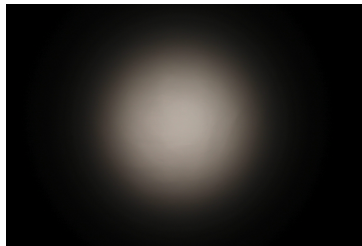

SAMSUNG

LED LC030C/040C G2
 FWHM / FWTM 17.0° / 30.0°
 Efficiency 86 %
 Peak intensity 7.6 cd/lm
 LEDs/each optic 1
 Light colour White
 Required components:
 F17438_HEKLA-G2-I

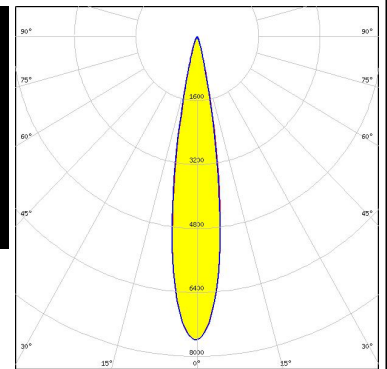

SEOUL SEMICONDUCTOR

LED MJT COB LES 14.5
 FWHM / FWTM 23.0° / 38.0°
 Efficiency 85 %
 Peak intensity 4.8 cd/lm
 LEDs/each optic 1
 Light colour White
 Required components:
 F17438_HEKLA-G2-I

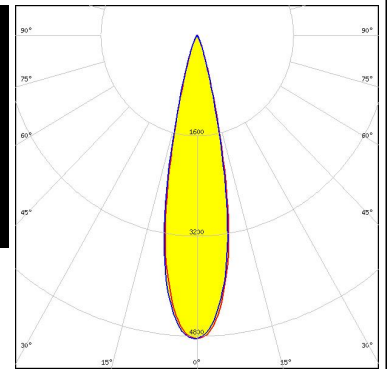
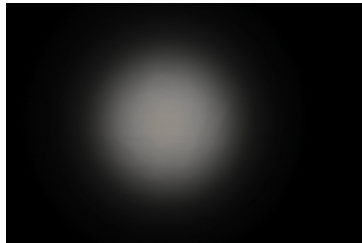

OPTICAL RESULTS (MEASURED):

TRIDONIC

LED SLE G7 LES09
FWHM / FWTM 14.0° / 25.0°
Efficiency 87 %
Peak intensity 11.1 cd/lm
LEDs/each optic 1
Light colour White
Required components:
F17435_HEKLA-G2-C

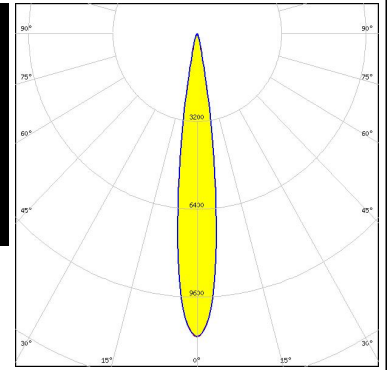
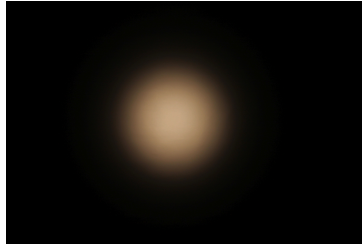



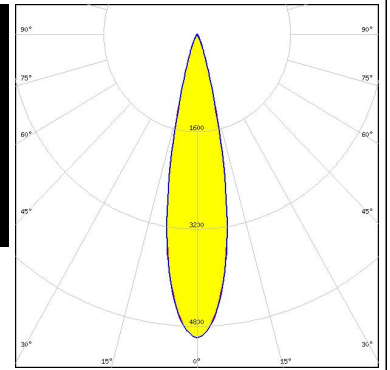

TRIDONIC

LED SLE G7 LES15
FWHM / FWTM 22.0° / 38.0°
Efficiency 85 %
Peak intensity 5 cd/lm
LEDs/each optic 1
Light colour White
Required components:
F17438_HEKLA-G2-I

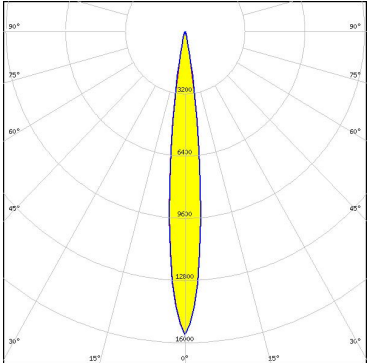

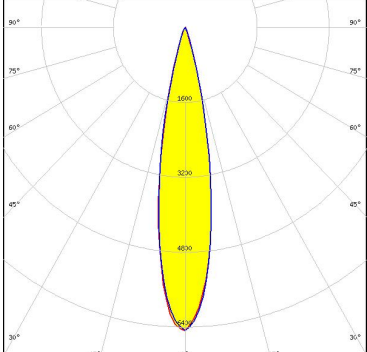
OPTICAL RESULTS (SIMULATED):

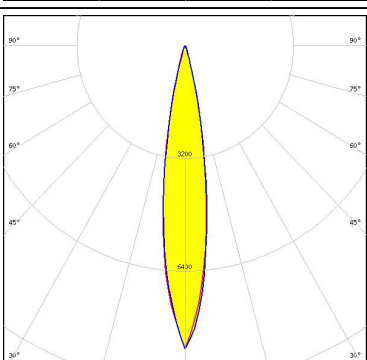
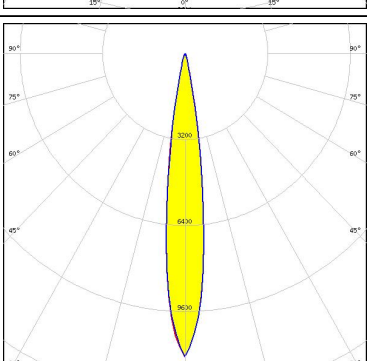
<p></p> <p>LED V6 HD Gen 7</p> <p>FWHM / FWTM 12.0° / 22.0°</p> <p>Efficiency 89 %</p> <p>Peak intensity 15.6 cd/lm</p> <p>LEDs/each optic 1</p> <p>Light colour White</p> <p>Required components: F15255_HEKLA-SOCKET-C</p>	
<p></p> <p>LED Vesta TW 13mm (25W) CSP</p> <p>FWHM / FWTM 20.0° / 34.0°</p> <p>Efficiency 90 %</p> <p>Peak intensity 6.5 cd/lm</p> <p>LEDs/each optic 1</p> <p>Light colour Tunable White</p> <p>Required components: C16142_HEKLA-SOCKET-K</p>	
<p></p> <p>LED Vesta TW 9mm (12W) CSP</p> <p>FWHM / FWTM 16.0° / 30.0°</p> <p>Efficiency 90 %</p> <p>Peak intensity 8.6 cd/lm</p> <p>LEDs/each optic 1</p> <p>Light colour Tunable White</p> <p>Required components: C16142_HEKLA-SOCKET-K</p>	
<p>CITIZEN</p> <p>LED CLU712/713</p> <p>FWHM / FWTM 14.0° / 26.0°</p> <p>Efficiency 87 %</p> <p>Peak intensity 11.3 cd/lm</p> <p>LEDs/each optic 1</p> <p>Light colour White</p> <p>Required components: F17438_HEKLA-G2-I</p>	

OPTICAL RESULTS (SIMULATED):

<p>CREE → LED</p> <p>LED: CHA0304 FWHM / FWTM: 10.0° / 20.0° Efficiency: 88 % Peak intensity: 19.5 cd/lm LEDs/each optic: 1 Light colour: White Required components: F17435_HEKLA-G2-C</p>	
<p>CREE → LED</p> <p>LED: CHA0410 FWHM / FWTM: 10.0° / 20.0° Efficiency: 88 % Peak intensity: 18.6 cd/lm LEDs/each optic: 1 Light colour: White Required components: F17435_HEKLA-G2-C</p>	
<p>CREE → LED</p> <p>LED: CHA0612 FWHM / FWTM: 12.0° / 22.0° Efficiency: 88 % Peak intensity: 15.3 cd/lm LEDs/each optic: 1 Light colour: White Required components: F17435_HEKLA-G2-C</p>	
<p>CREE → LED</p> <p>LED: CMA1306 FWHM / FWTM: 12.0° / 22.0° Efficiency: 88 % Peak intensity: 16.1 cd/lm LEDs/each optic: 1 Light colour: White Required components: F17435_HEKLA-G2-C</p>	

OPTICAL RESULTS (SIMULATED):

CREE LED

LED CMU10xx
 FWHM / FWTM 16.0° / 28.0°
 Efficiency 88 %
 Peak intensity 9.9 cd/lm
 LEDs/each optic 1
 Light colour White
 Required components:
 F17435_HEKLA-G2-C

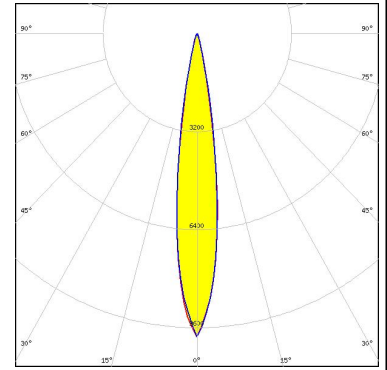

CREE LED

LED CXA/B 13xx
 FWHM / FWTM 12.0° / 22.0°
 Efficiency 88 %
 Peak intensity 14.9 cd/lm
 LEDs/each optic 1
 Light colour White
 Required components:
 F17439_HEKLA-G2-J

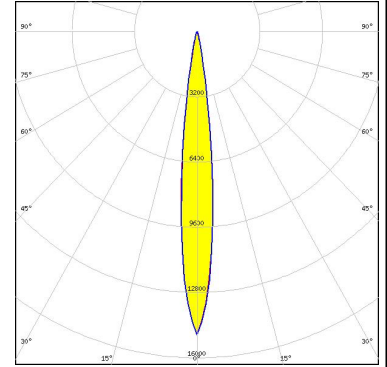

CREE LED

LED CXA/B 15xx
 FWHM / FWTM 14.0° / 26.0°
 Efficiency 87 %
 Peak intensity 11 cd/lm
 LEDs/each optic 1
 Light colour White
 Required components:
 F17436_HEKLA-G2-D

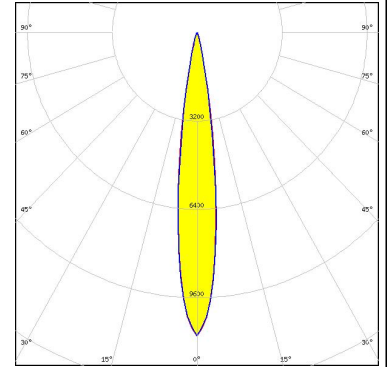

CREE LED

LED CXA/B 1830
 FWHM / FWTM 22.0° / 36.0°
 Efficiency 87 %
 Peak intensity 5.5 cd/lm
 LEDs/each optic 1
 Light colour White
 Required components:
 Bender Wirth: 637b Hekla

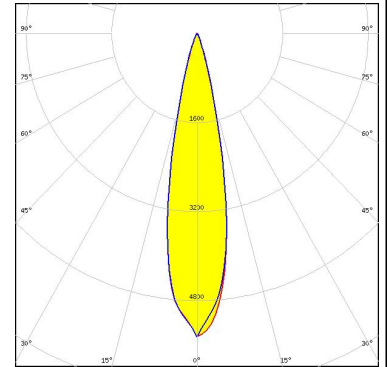

OPTICAL RESULTS (SIMULATED):

PHILIPS

LED Fortimo SLM L09 CoB
 FWHM / FWTM 16.0° / 28.0°
 Efficiency 88 %
 Peak intensity 10 cd/lm
 LEDs/each optic 1
 Light colour White
 Required components:
 F17435_HEKLA-G2-C

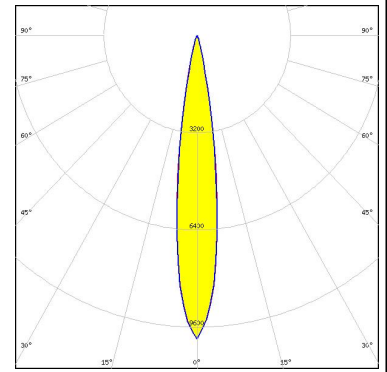

PHILIPS

LED Fortimo SLM L13 CoB
 FWHM / FWTM 16.0° / 28.0°
 Efficiency 87 %
 Peak intensity 10.1 cd/lm
 LEDs/each optic 1
 Light colour White
 Required components:
 Bender Wirth: 632a Hekla XL

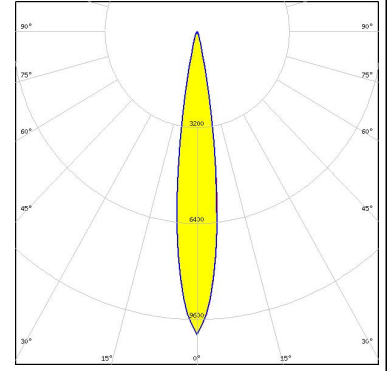

SAMSUNG

LED LC003D / LC006D / LC009D / LC013D
 FWHM / FWTM 16.0° / 28.0°
 Efficiency 87 %
 Peak intensity 8.8 cd/lm
 LEDs/each optic 1
 Light colour White
 Required components:
 F17435_HEKLA-G2-C

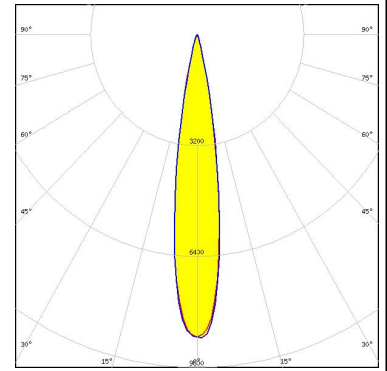

TRIDONIC

LED SLE G7 LES13
 FWHM / FWTM 20.0° / 34.0°
 Efficiency 87 %
 Peak intensity 6.1 cd/lm
 LEDs/each optic 1
 Light colour White
 Required components:
 F17438_HEKLA-G2-I

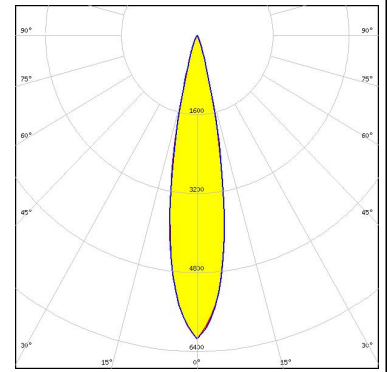

GENERAL INFORMATION:

NOTE: The typical beam angle will be changed by different color, chip size and chip position tolerance. The typical total beam angle is the full angle measured where the luminous intensity is half of the peak value.

Due to use of high power COB's with this product, special attention to proper thermal design is highly recommended. LEDiL has no liability for direct, indirect or consecutive damages arising from the LEDiL products being used outside of the recommended temperature range.

MATERIALS:

As part of our continuous research and improvement processes, and to ensure the best possible quality and availability of our products, LEDiL reserves the right to change material grades without notice.

PRODUCT DATA USER AGREEMENT AND DISCLAIMER:

The measured data in the provided downloadable LEDiL Product Datasheets and Mechanical 2D-Drawings is rounded and provided as reference for planning. LEDiL Oy's optical specifications have been verified by conducting performance testing of the products in accordance with the company's quality system. The reported data are averaged results of multiple measurements with typical variation. LEDiL Oy reserves the right to without prior notification make changes and improvements to its products.

LEDiL Oy assumes neither warranty, nor guarantee nor any other liability of any kind for the contents and correctness of the provided data. The provided data has been generated with highest diligence but the provided data may in reality not represent the complete possible variation range of all intrinsic parameters. Therefore, in certain cases a deviation from the provided data could occur.

LEDiL Oy reserves the right to undertake technical changes of its products without further notification which could lead to changes in the provided data. LEDiL Oy assumes no liability of any kind for the possible deviation from any provided data or any other damage resulting from the usage of the provided data.

The user agrees to this disclaimer and user agreement with the download or usage of the provided files.

LEDiL Oy

Joensuunkatu 13
FI-24240 SALO
Finland

LEDiL Inc.

228 West Page Street
Suite D
Sycamore IL 60178
USA

Ledil Optics Technology (Shenzhen) Co., Ltd.

405 , Block B
Casic Motor Building
Shenzhen 518057
P.R.CHINA

Local sales and technical support

[www.ledil.com/
where_to_buy](http://www.ledil.com/where_to_buy)

Shipping locations

Salo, Finland
Hong Kong, China

Distribution Partners

[www.ledil.com/
where_to_buy](http://www.ledil.com/where_to_buy)