



TAOGLAS®



Datasheet

Guardian 5in1 Adhesive and Wall Mount Antenna

Part No:
MA952.A.LBIVW.001

Description:

Guardian 5in1 Adhesive and Wall Mount Antenna 4*LTE GNSS Antenna

Features:

Low-Profile Adhesive Mount Panel Antenna

4* LTE MIMO 600MHz-6GHz

1* GPS-GLONASS-GALILEO-BeiDou Antenna

Covering Worldwide LTE Bands

Covering 5G NR Sub 6GHz Bands

Covering CAT-M1 & NB-IoT Bands

Includes 3G / 2G Fallback

IP67 Waterproof ASA Enclosure

Dimensions: 146*134*20mm

3m Low Loss KSR200-P and RG-174 Cables with SMA(M) connectors

Cables and Connectors Customizable

RoHS & REACH Compliant

1. Introduction	3
2. Specifications	4
3. Active Antenna Characteristics	8
4. Antenna Characteristics	15
5. Radiation Patterns	19
6. Mechanical Drawing	34
7. Packaging	35
Changelog	36

Taoglas makes no warranties based on the accuracy or completeness of the contents of this document and reserves the right to make changes to specifications and product descriptions at any time without notice. Taoglas reserves all rights to this document and the information contained herein.

Reproduction, use or disclosure to third parties without express permission is strictly prohibited.

Copyright © Taoglas Ltd.



1. Introduction



The MA952 Guardian is a next generation 5in1 combination antenna. It is the world-first panel antenna designed for IoT Gateway and Router devices with multiple wireless technologies. This antenna delivers powerful MIMO antenna technology for LTE and Sub-6GHz 5G bands covering 600MHz - 6GHz. This antenna is designed for LTE bands worldwide (including 3G & 2G fallback) for access points, terminals, and routers. CAT-M1 and NB-IoT and the recently introduced 600MHz Extended LTE Band 71 are also covered. This wide bandwidth enables designers to cover a wide range of technologies by installing a single antenna installation. The MA952 Guardian also covers GPS/GLONASS/BeiDou/Galileo bands along with 4 LTE MIMO antennas for superb location accuracy. It is a heavy-duty, fully IP67 waterproof external M2M antenna available in both wall and adhesive mount versions.

Typical use cases include:

- IoT Gateways and Routers
- HD Video Streaming
- Transportation

4G wireless applications demand high-speed data uplink and downlink. High efficiency and high gain MIMO antennas are necessary to achieve the required signal to noise ratio and throughput required to solve these challenges. Taoglas also takes care to have high isolation among these antennas to prevent self-interference. Low loss cables used to keep efficiency high over long cable lengths.

The GPS-GLONASS-GALILEO-BEIDOU active antenna has been carefully designed for excellent performance across all L1 GNSS bands, leading to higher location accuracy and stability of tracking in urban environments.

The housing is IP67 waterproof and the adhesive mount version comes with 3M adhesive. The antenna can be mounted internally or externally on a vehicle. The MA952 comes with 3m, low loss KSR200-P coaxial cables for the LTE antennas as standard and 3m, RG-174 on the GNSS connection. Customized cables and connector versions are also available. Contact your regional Taoglas customer support for more information on how to integrate the MA952 or sales support.

2. Specifications

GNSS Frequency Band							
GPS/QZSS	L1 1575.42MHz	L2 1227.6MHz	L5 1176.45MHz	L6 1278.75MHz			
	■	□	□	□			
GLONASS	L5R 1176.45MHz	L3PT 1201.5MHz	L2PT 1246MHz	L1CR 1575.42MHz	L1PT 1602MHz		
	□	□	□	■	■		
Galileo	E5a 1176.45MHz	E5b 1201.5MHz	E4 1215MHz	E3 1256MHz	E6 1278.75MHz	E2 1561MHz	E1 1575.42MHz
	□	□	□	□	□	■	■
Beidou	B1 1561MHz	B2 1207.14MHz	B3 1268.52MHz				
	■	□	□				
Compass	E5B(B2)/ E6(B3) 1268.56MHz	E2(B1) 1561MHz					
	□	■					
SBAS	Omnistar 1542.5MHz	WAAS/EGN OS 1575.42MHz					
	□	■					

GNSS ELECTRICAL			
Frequency (MHz)	1561	1575.42	1602
VSWR (max.)	2.0:1	2.0:1	2.0:1
Passive Antenna Efficiency (%) (Without cable loss)	63	48	57
Passive Antenna Gain at Zenith (dBi) (Without cable loss)	3	1.98	3.01
Axial Ratio (dB)	<9.7	<14.2	<5.9
Polarization	RHCP		
Impedance	50Ω		
Cable	RG174, 3 meter standard, fully customizable		
Connector	SMA(M) standard, fully customizable		

LNA and Filter Electrical Properties			
Frequency (MHz)	1561	1575.42	1602
VSWR (max.)	2.0:1	2.0:1	2.0:1
Gain@1.8V (Typ.)	28 dB	28 dB	28 dB
Gain@3.0V (Typ.)	30 dB	30 dB	30 dB
Gain@5.5V (Typ.)	33 dB	33 dB	33 dB
Noise@1.8V (Typ.)	1.13 dB	1.13 dB	1.13 dB
Noise@3.0V (Typ.)	1.13 dB	1.13 dB	1.13 dB
Noise@5.5V (Typ.)	1.14 dB	1.14 dB	1.14 dB
Power consumption@1.8V (Typ.)	7.9 mA		
Power consumption@3.0V (Typ.)	9.0 mA		
Power consumption@5.5V (Typ.)	9.9 mA		
Total Specification (Through Antenna, SAW Filter and LNA)			
Frequency (MHz)	1561	1575.42	1602
Gain@3V (dBi)	28 ± 3	28 ± 3	28 ± 3
Output Impedance	50 Ω		

LTE Antenna

Frequency (MHz)		5G NR Band 71	LTE700	GSM850/900	5G NR Band 74, 75, 76	DCS	PCS	UMTS1	LTE2600	5G NR Band 77, 78, 79	LTE5200/WiFi5800
		617 ~698	698 ~806	824 ~960	1427 ~1518	1710 ~1880	1850 ~1990	1920 ~2170	2490 ~2690	3300 ~3500	5150 ~5925
Efficiency (%)											
MIMO 1	3m	33.03	42.85	54.27	56.48	62.58	57.98	55.61	57.04	43.44	32.23
MIMO 2	3m	39.89	55.17	56.75	45.73	48.59	43.62	41.21	40.46	37.88	32.60
MIMO 3	3m	46.38	51.55	55.06	43.81	46.39	45.05	44.82	51.22	42.86	34.02
MIMO 4	3m	32.78	34.87	35.74	49.14	61.44	58.48	54.84	53.27	42.94	28.30
Average Gain (dB)											
MIMO 1	3m	-4.81	-3.68	-2.65	-2.48	-2.04	-2.37	-2.55	-2.44	-3.62	-4.92
MIMO 2	3m	-3.99	-2.58	-2.46	-3.40	-3.13	-3.60	-3.85	-3.93	-4.22	-4.87
MIMO 3	3m	-3.34	-2.88	-2.59	-3.58	-3.34	-3.46	-3.49	-2.91	-3.68	-4.68
MIMO 4	3m	-4.84	-4.58	-4.47	-3.09	-2.12	-2.33	-2.61	-2.74	-3.67	-5.48
Peak Gain (dBi)											
MIMO 1	3m	1.42	1.28	3.56	3.24	3.55	3.21	3.21	3.11	3.06	3.84
MIMO 2	3m	1.59	2.76	3.38	3.42	3.06	3.06	4.08	4.76	2.07	1.92
MIMO 3	3m	1.93	2.26	2.86	3.12	4.71	4.71	4.32	3.89	2.88	2.39
MIMO 4	3m	1.08	0.76	3.02	3.62	3.11	3.11	2.92	2.77	2.97	2.46
Impedance		50Ω									
Polarization		Linear									
Radiation Pattern		Omni									
Max. input power		2W									

Mechanical	
Height	20 ±2 mm
Planner Dimension	146*134 mm
Casing	ASA
Cable	KSR200-P, 3000 mm for LTE RG-174, 3000mm for GNSS
Connector	SMA(M)
Weight	450g
Environmental	
Protection	IP67
Temperature Range	-40°C to 85°C
Humidity	Non-condensing 65°C 95% RH

3. Active Antenna Characteristics

3.1 Block Diagram (Active antenna)

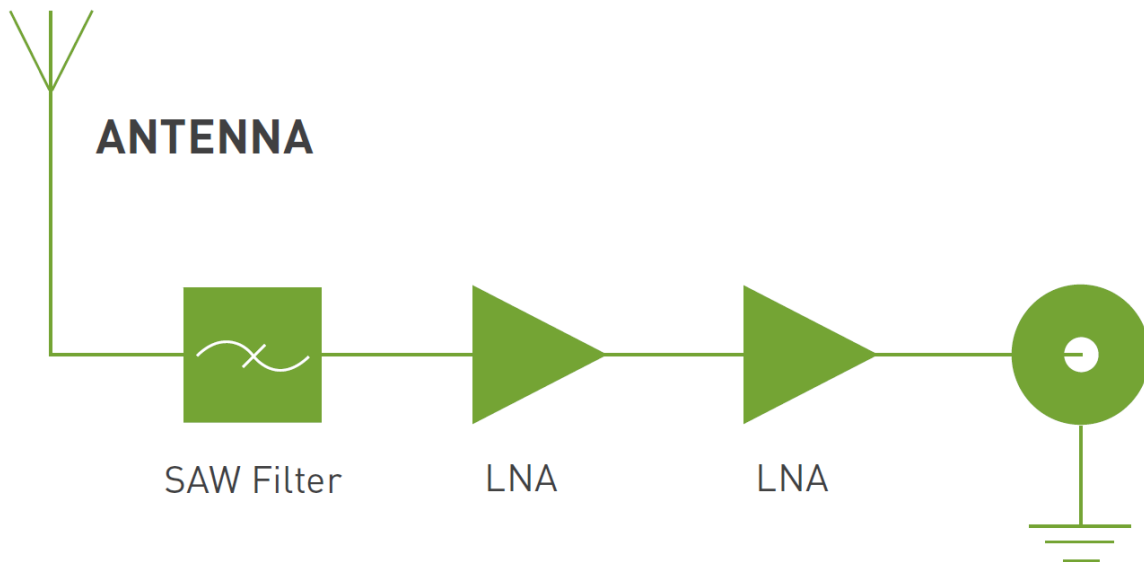

3.2 Passive Antenna Return Loss

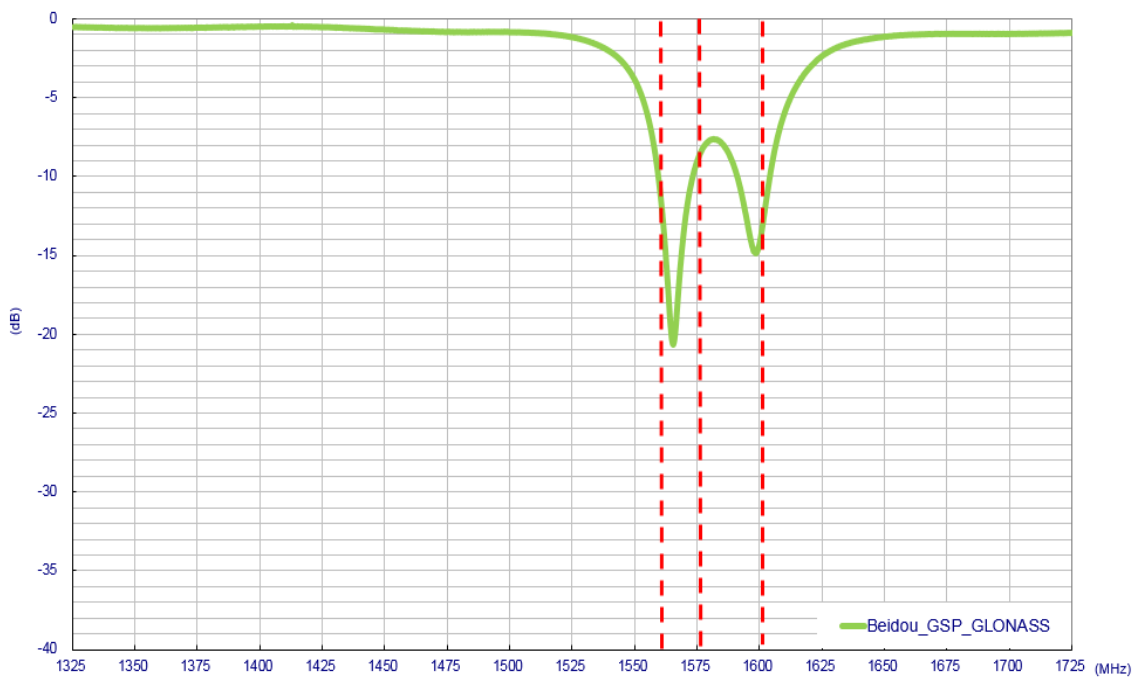

3.3 Passive Antenna Efficiency

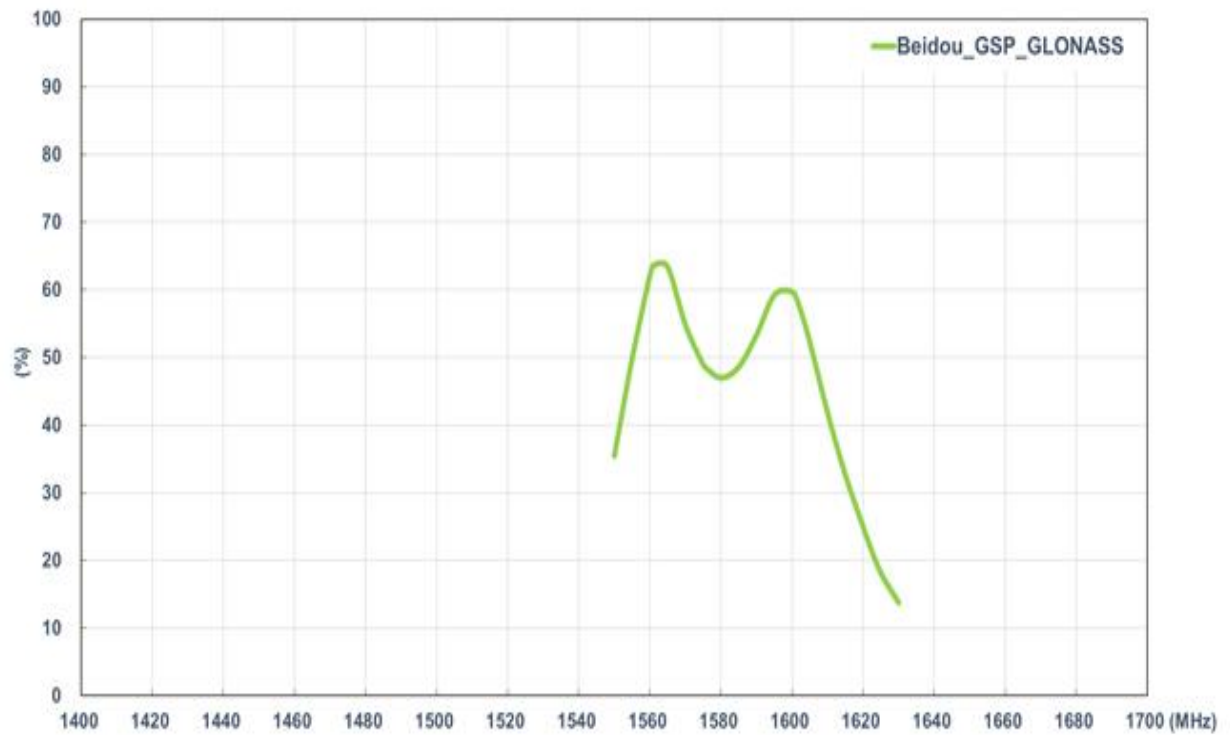

3.4 Passive Antenna Average Gain

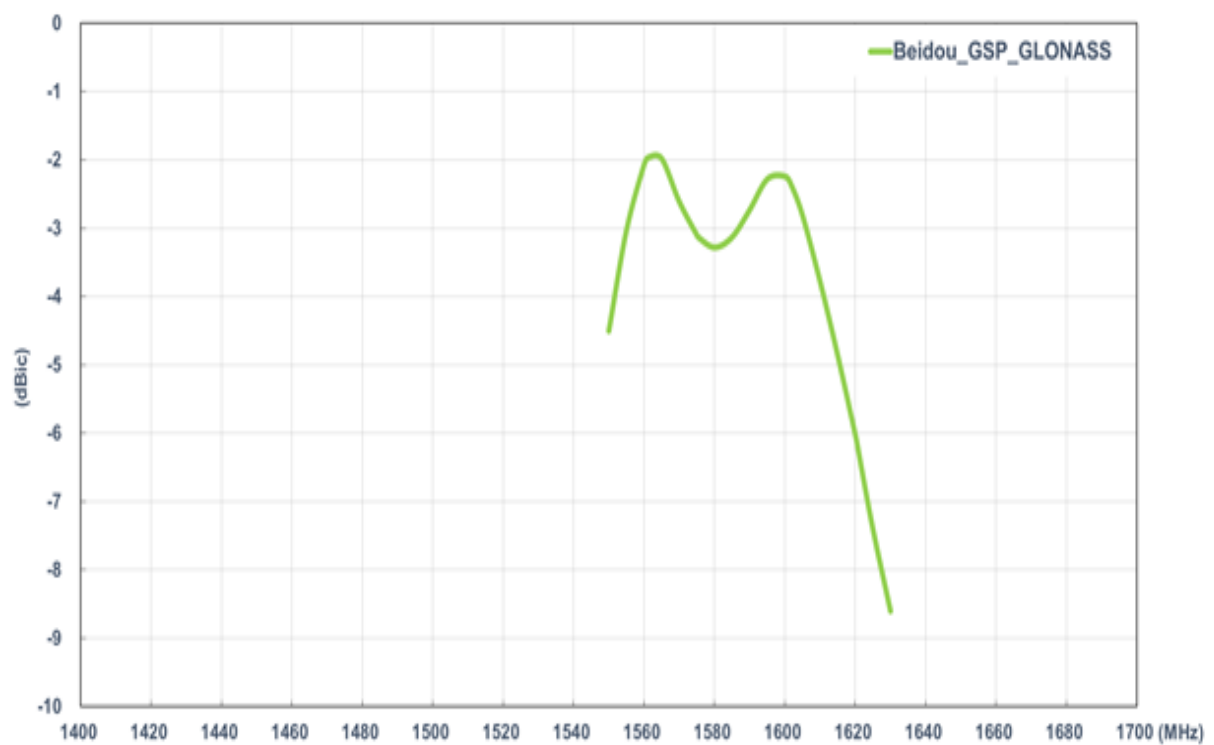

3.5 Passive Antenna Peak Gain

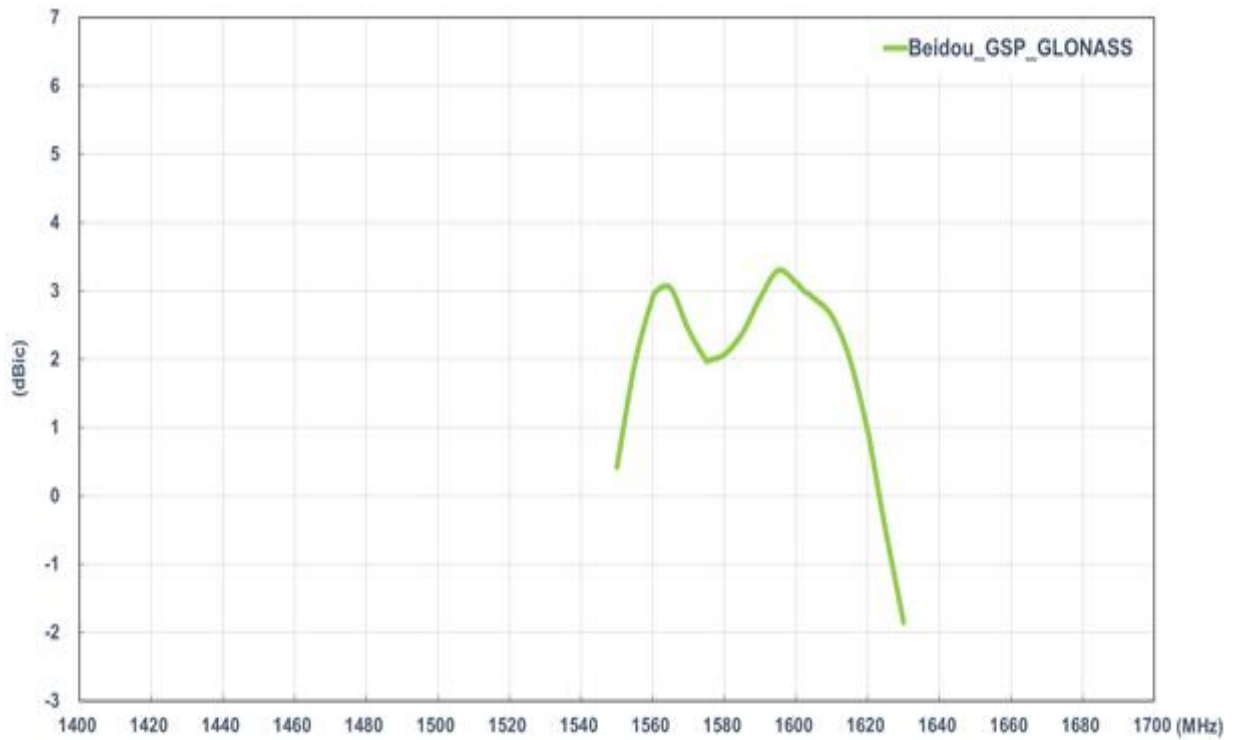

3.6 Passive Antenna Axial Ratio (Zenith is at 0°)

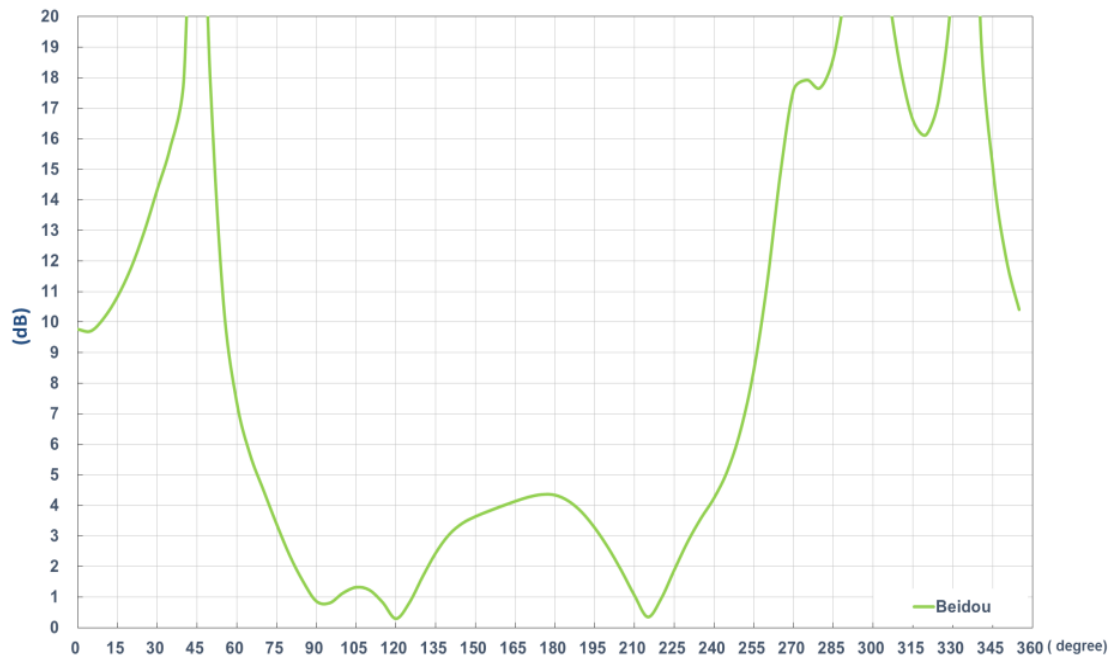

1561MHz

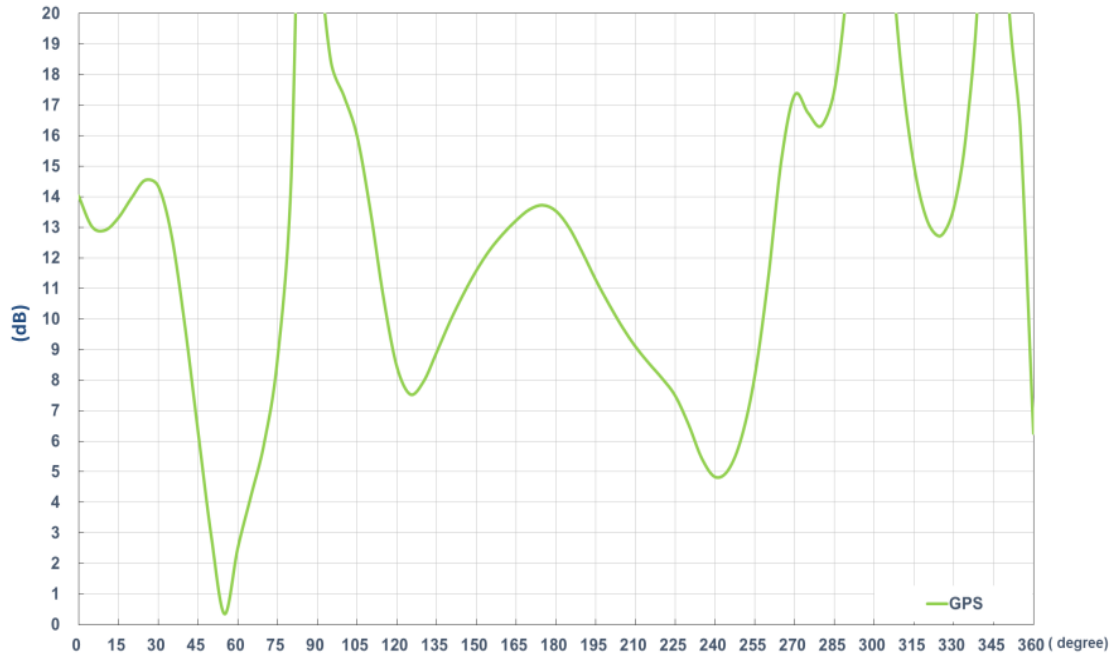

1575.42MHz

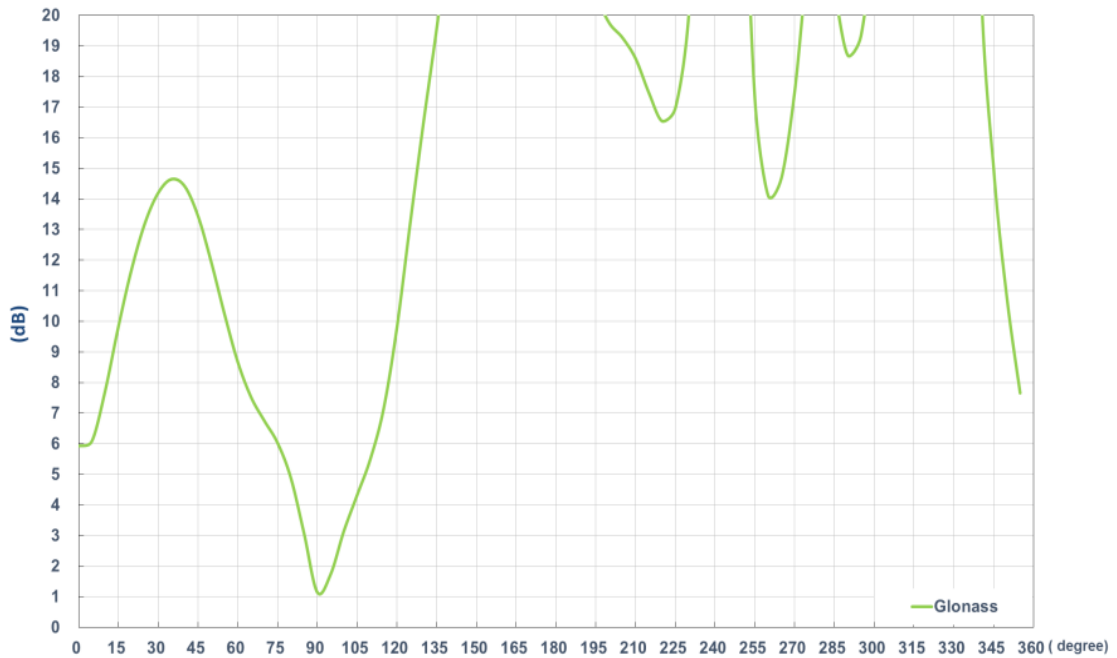

1602MHz

3.7 Active measurements

LNA Gain @ 3.0V

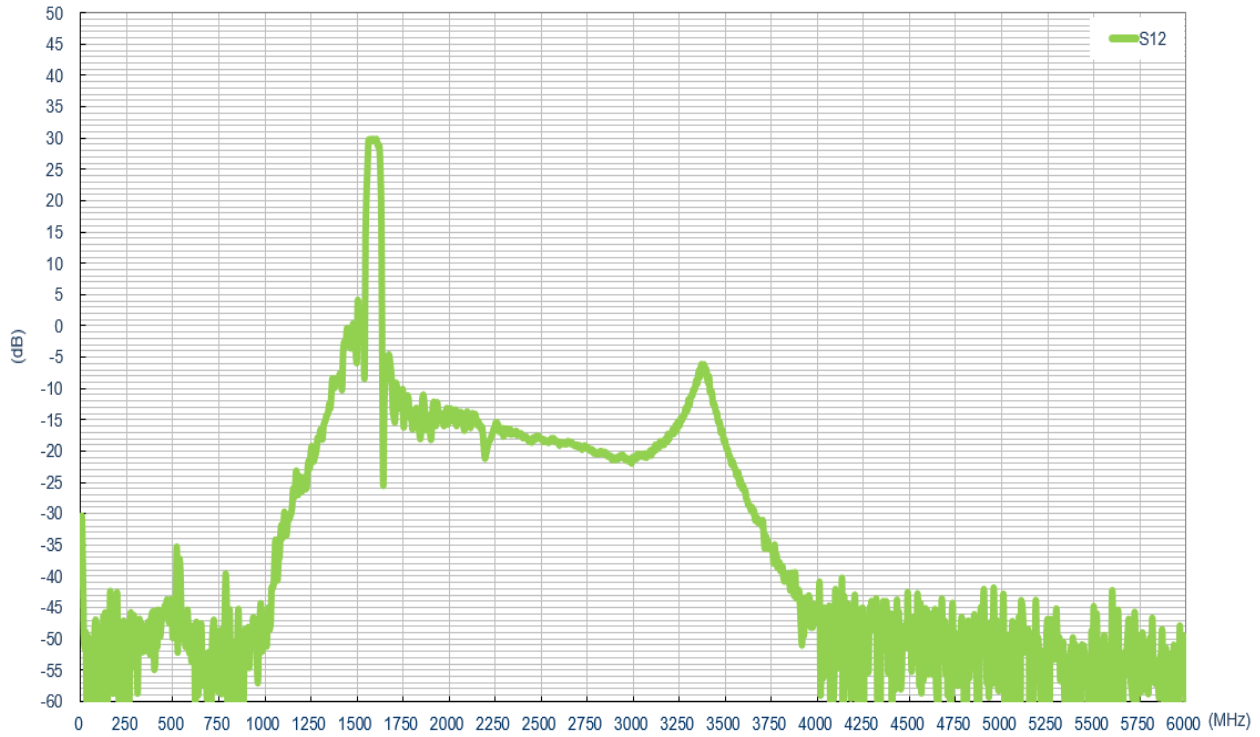

Noise Figure @ 3.0V

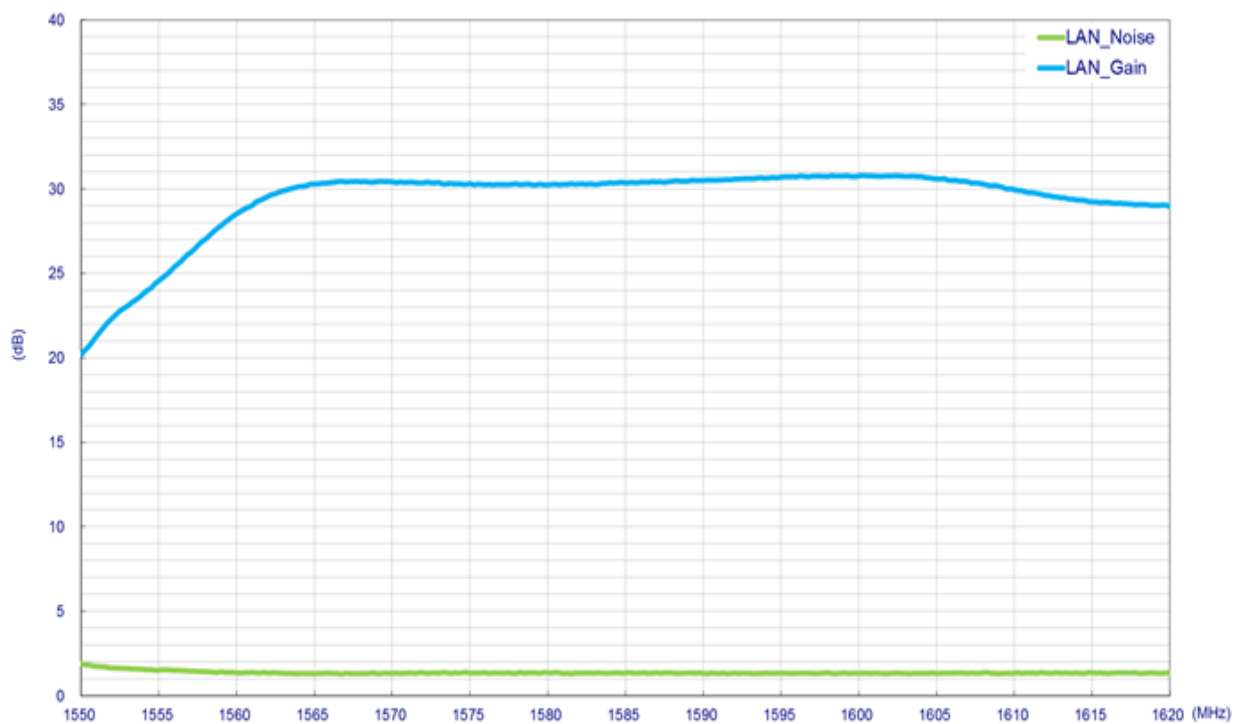

3.8 Passive Antenna 2D Radiation Patterns

XY Plane

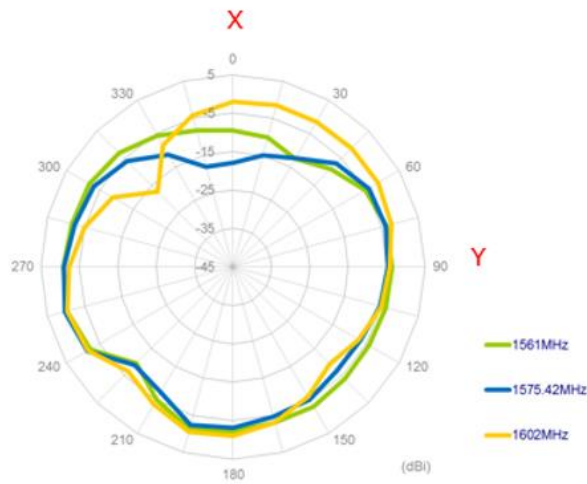

XY Plane

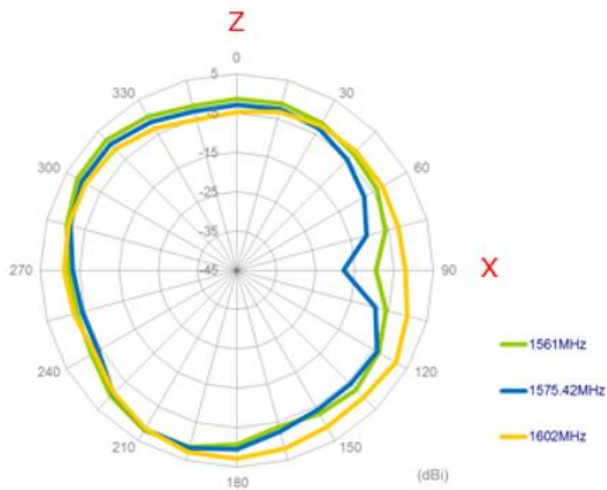

XY Plane

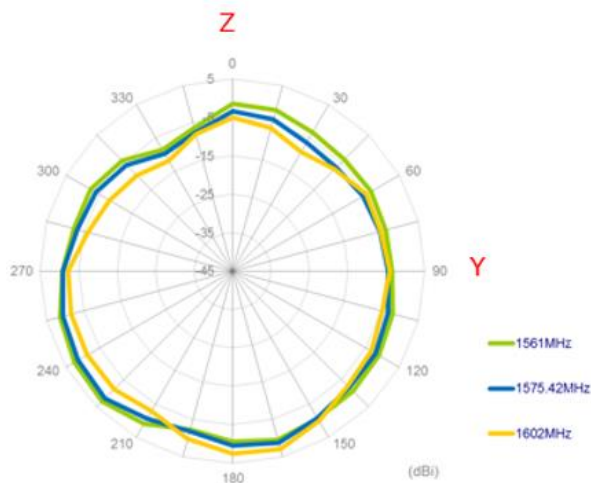

3.9 Passive Antenna 3D Radiation patterns

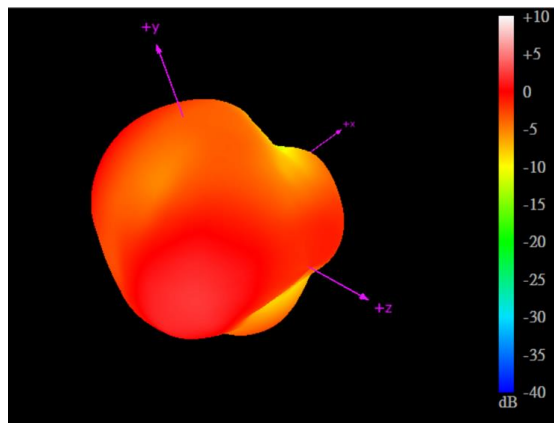

1561MHz

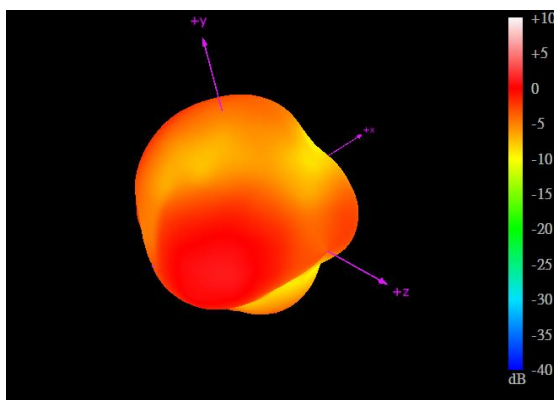

1575.42MHz

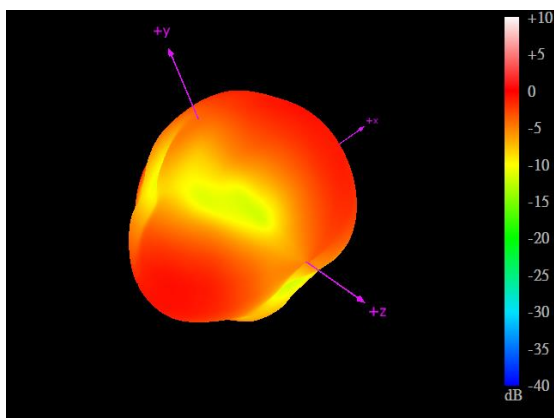

1602MHz

4. Antenna Characteristics

4.1 Test Setup

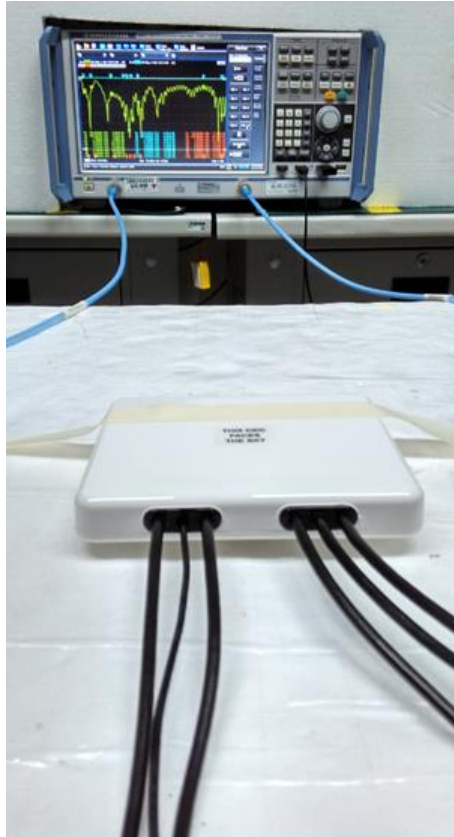

Free space

4.2 Return Loss

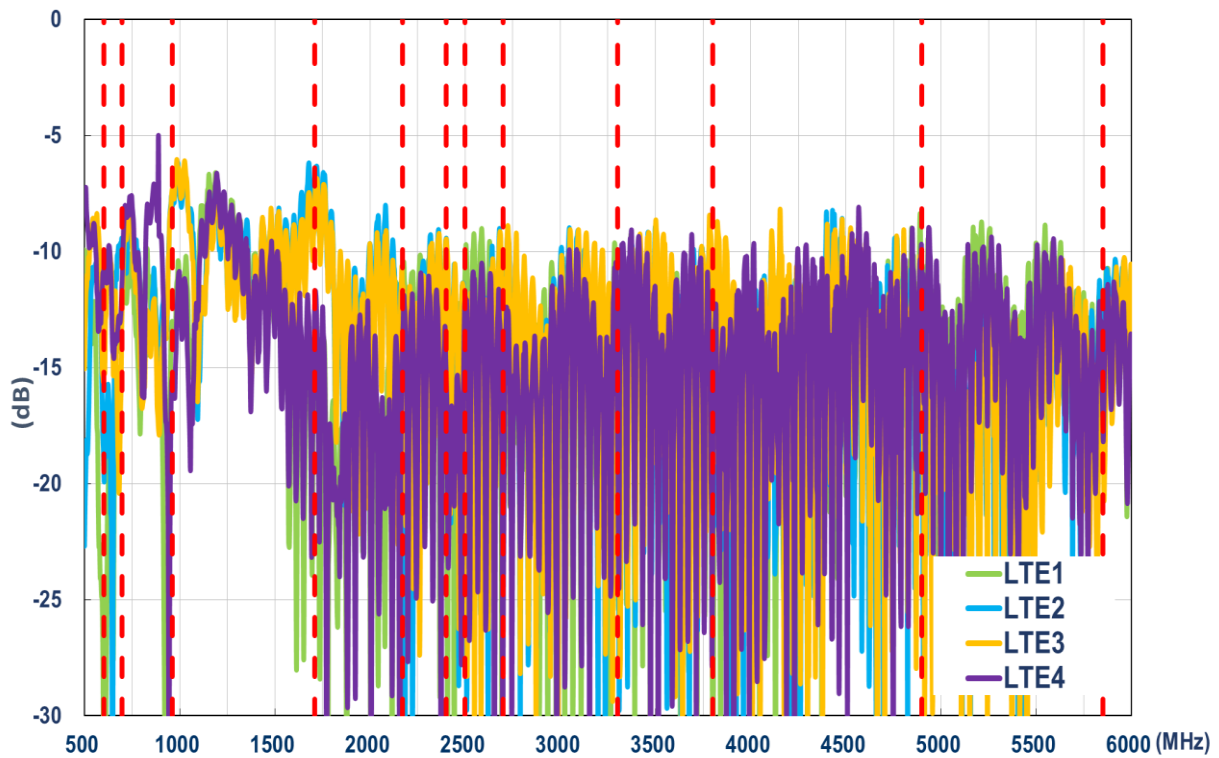

4.3 Isolation

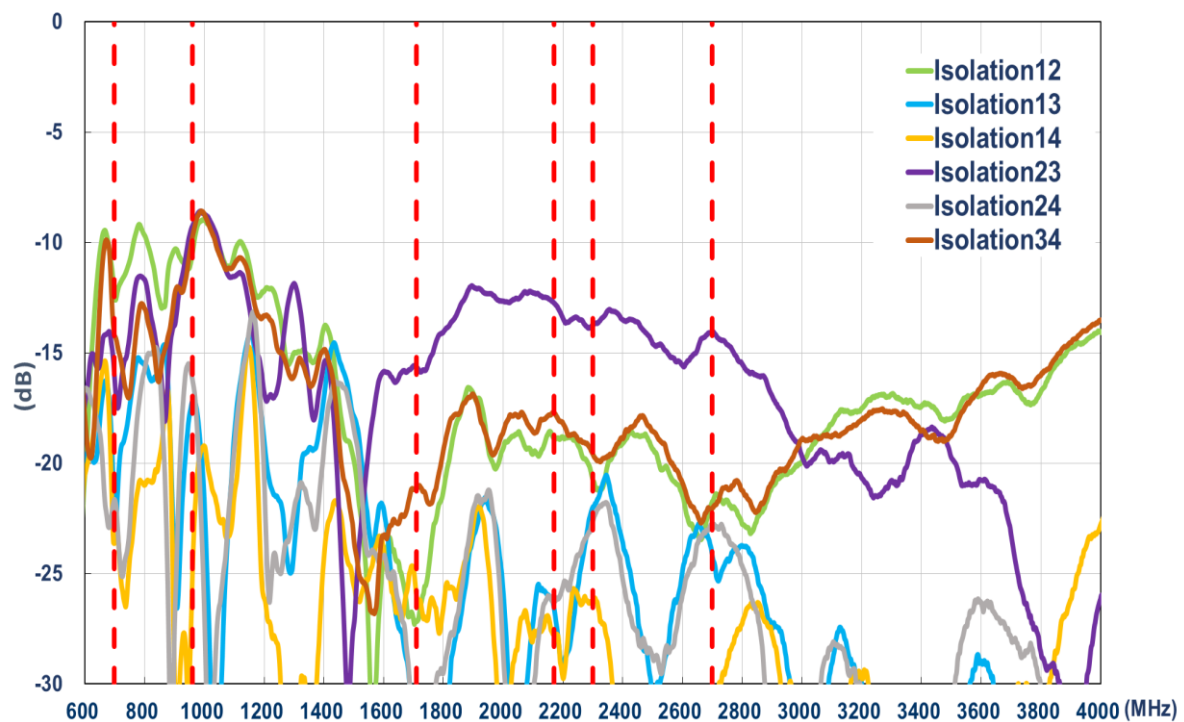

4.4 Efficiency

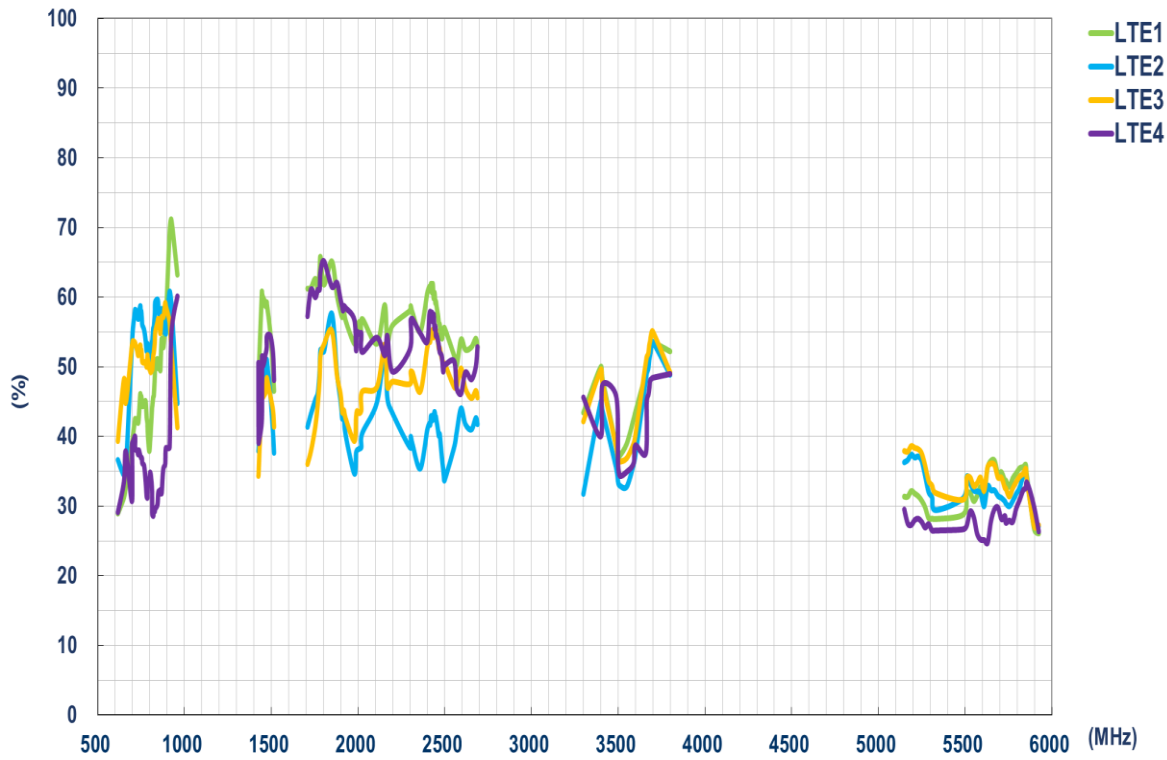

4.5 Average gain

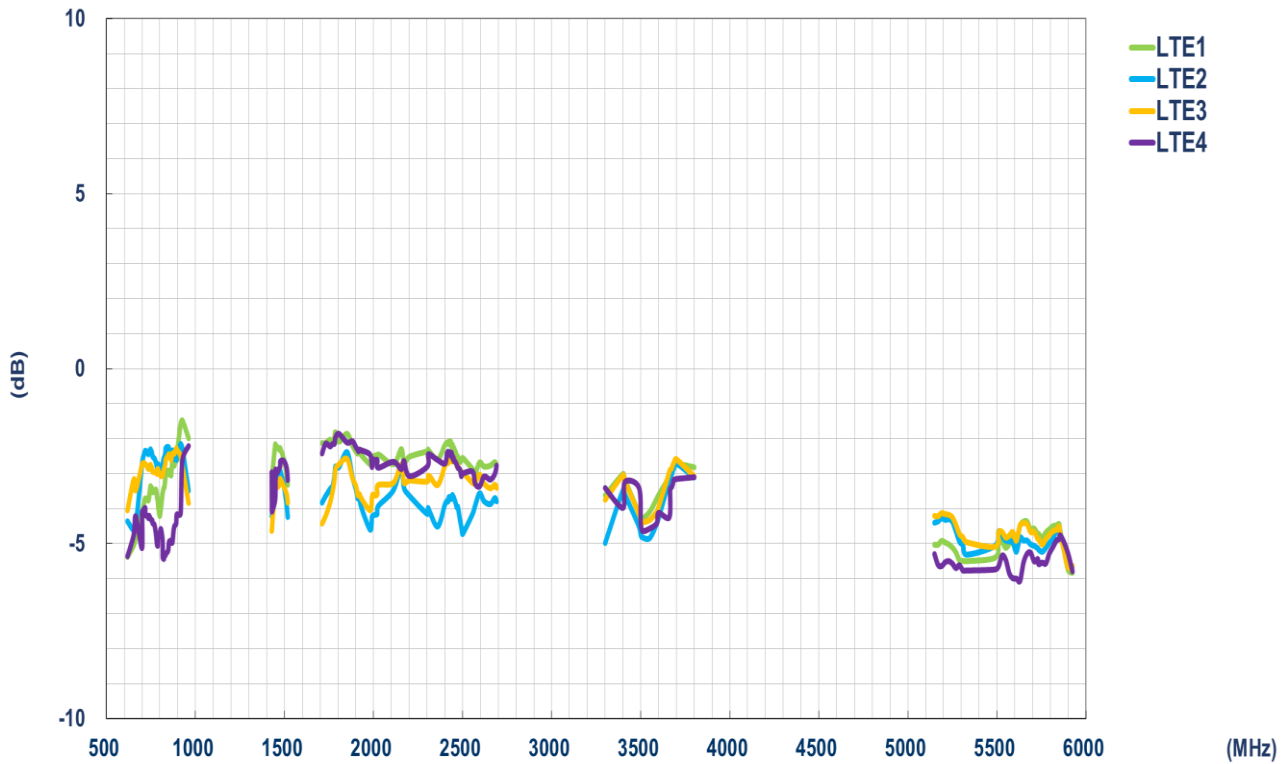

4.6 Peak gain

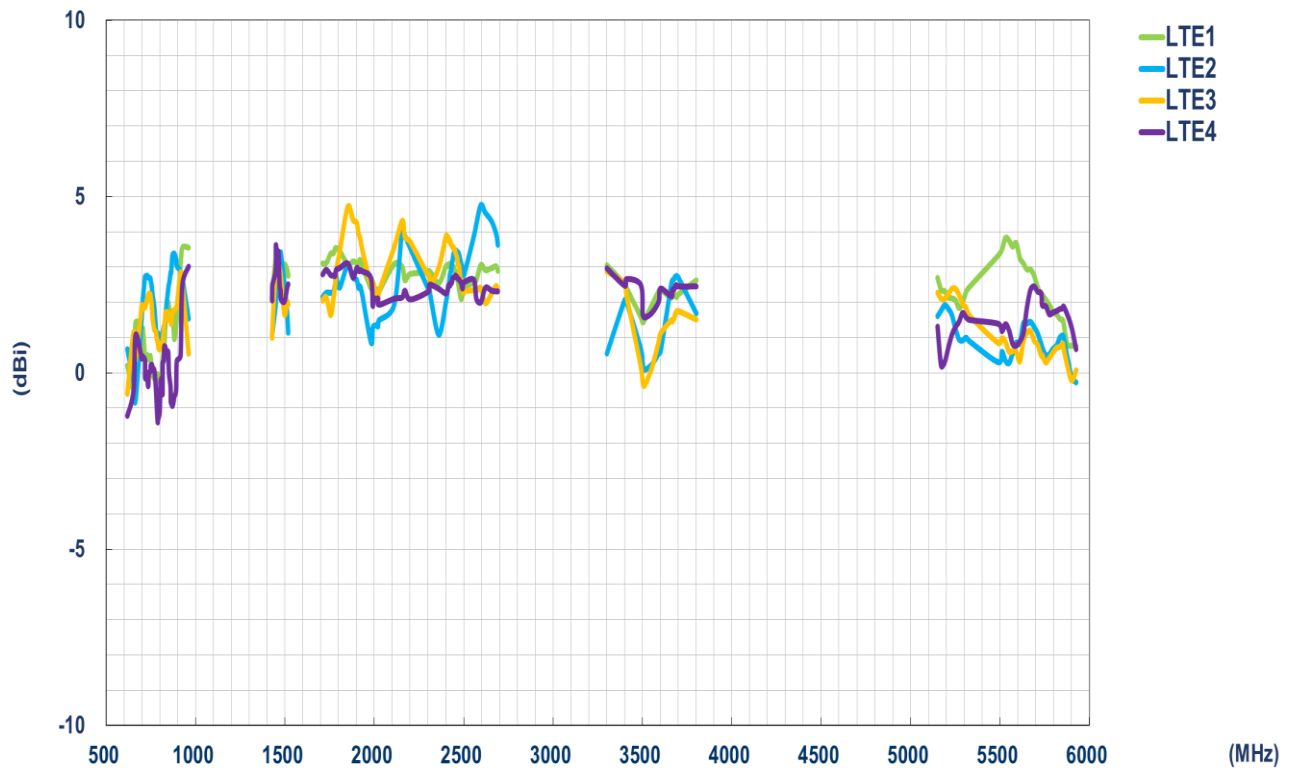

5. Radiation Patterns

5.1 Test Setup



Free space

5.2 2D Radiation Patterns

5.2.1 LTE MIMO1

XY Plane

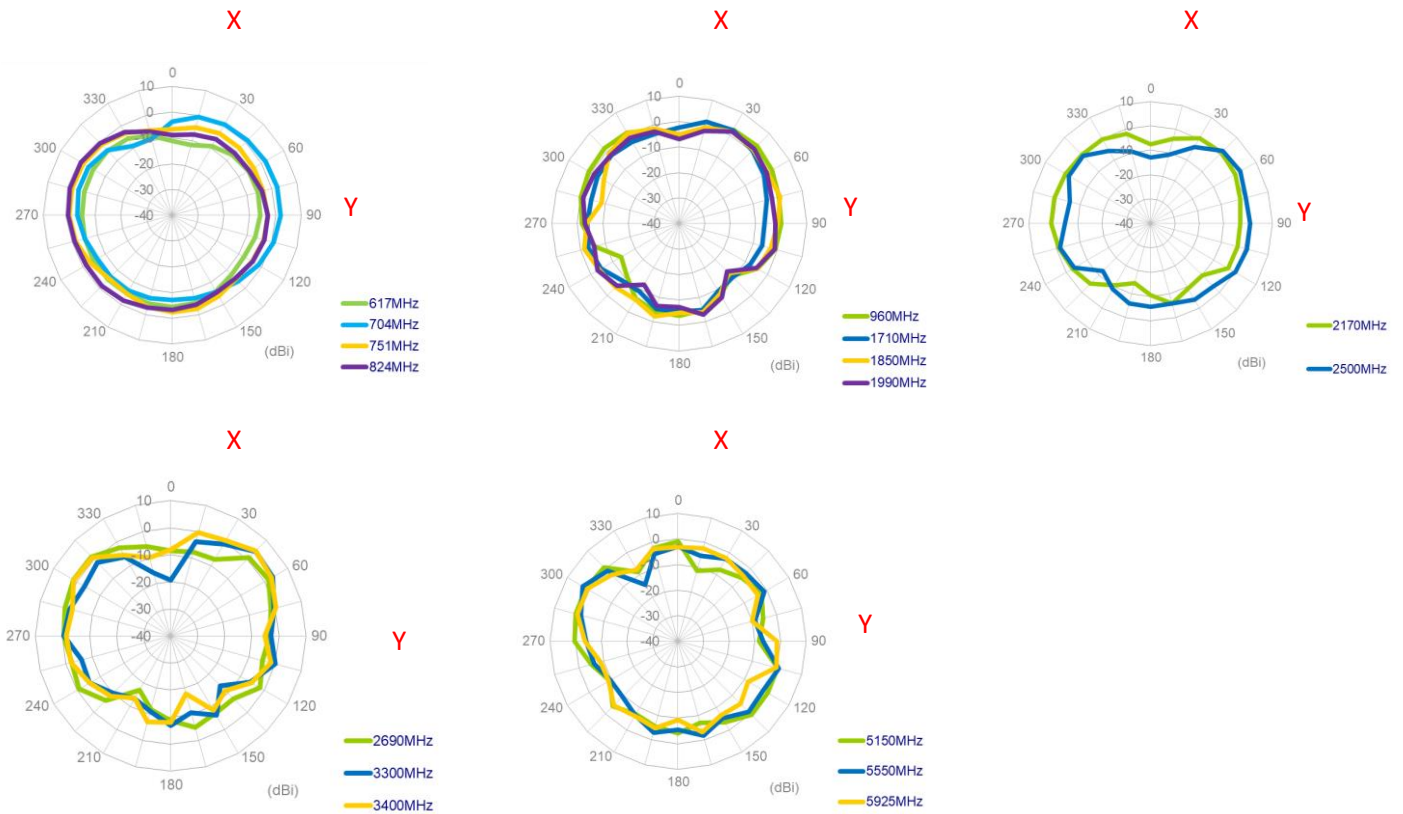

XZ Plane

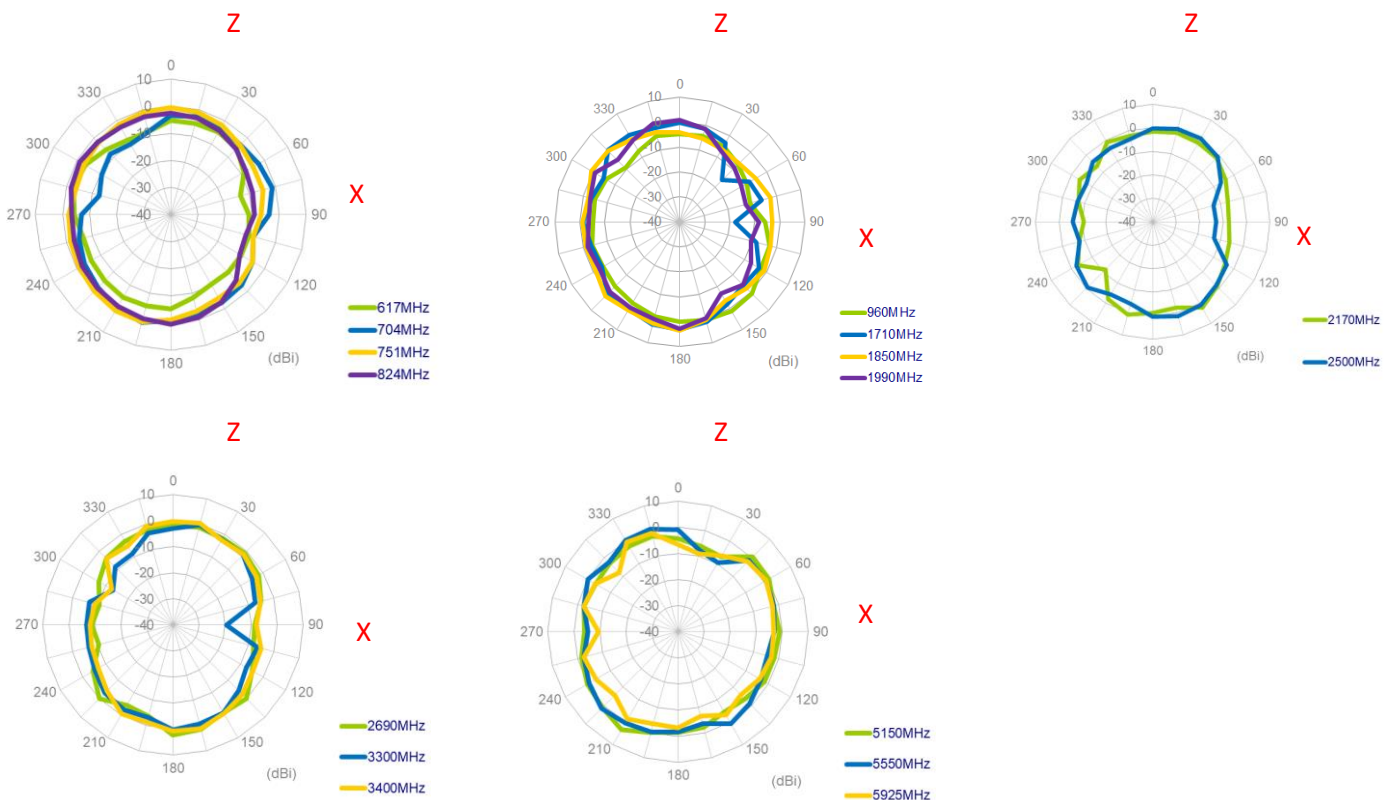

YZ Plane

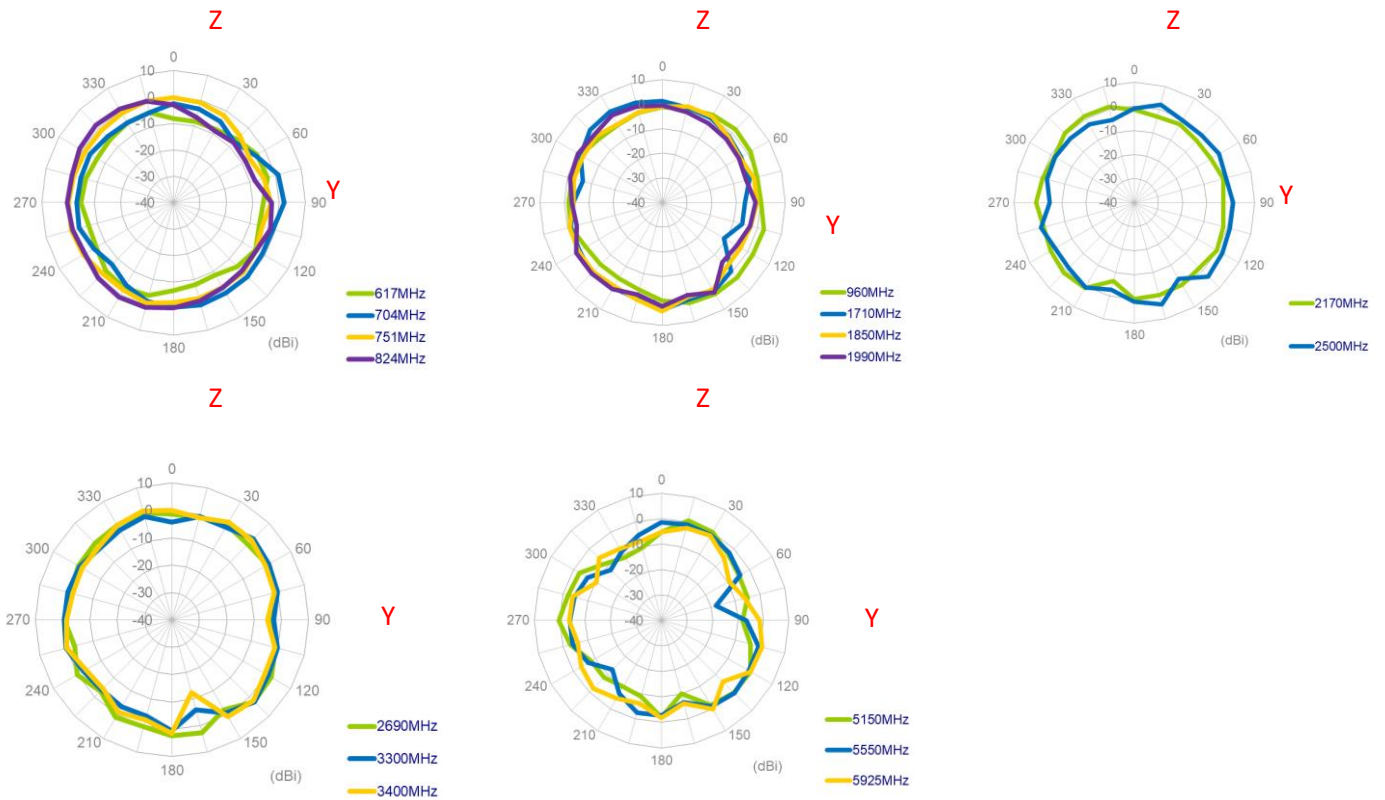

5.2.1 LTE MIMO2

XY Plane

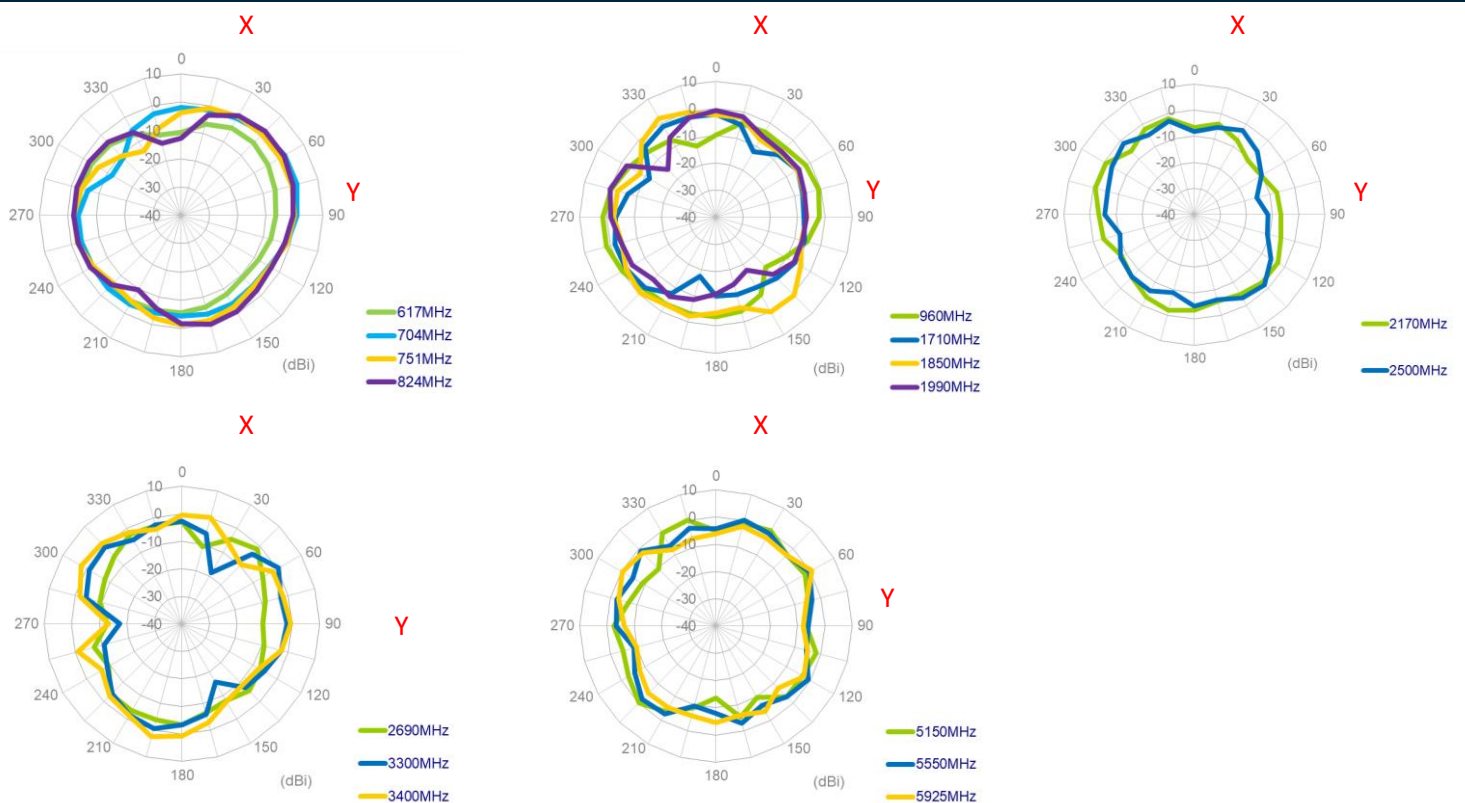

XZ Plane

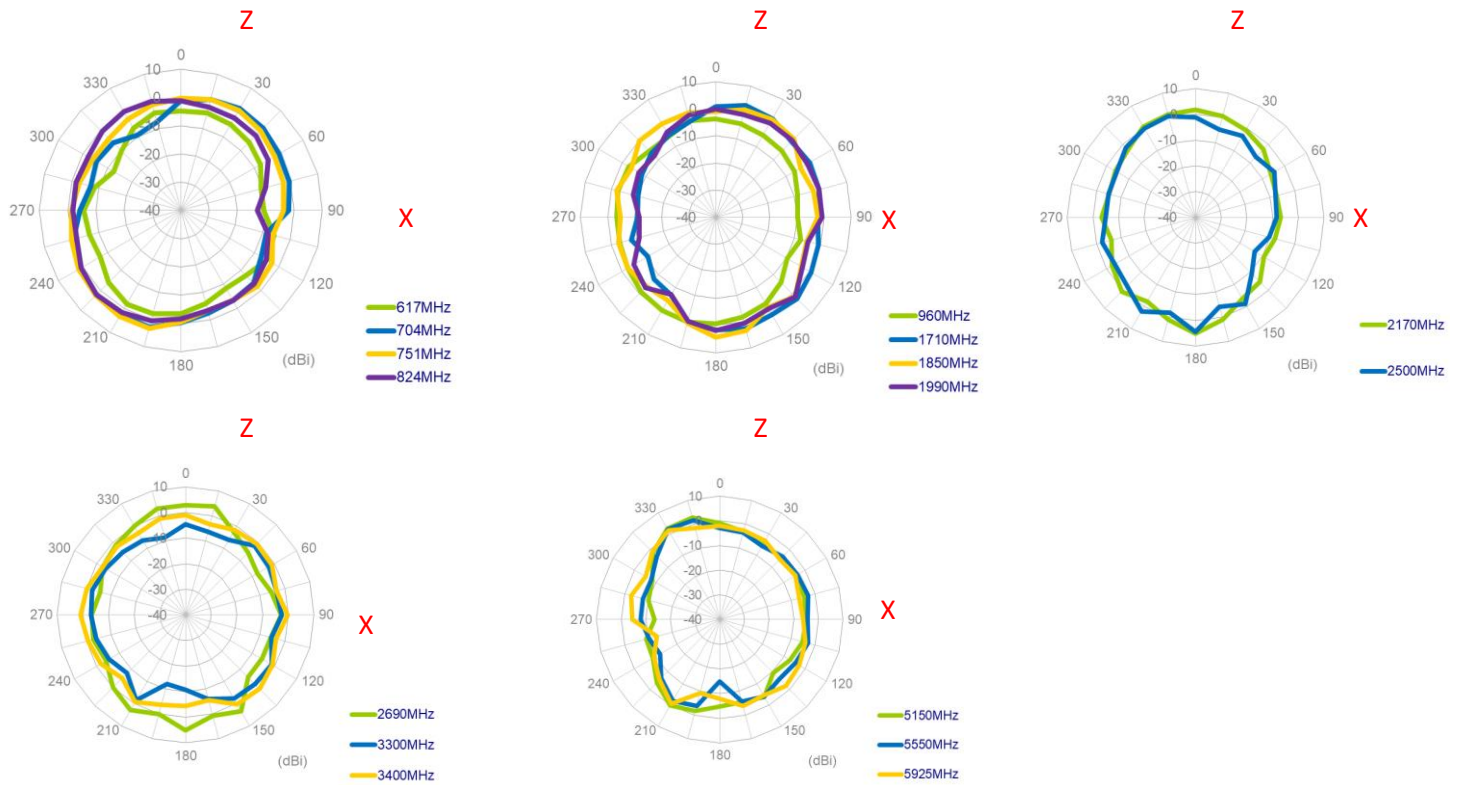

YZ Plane

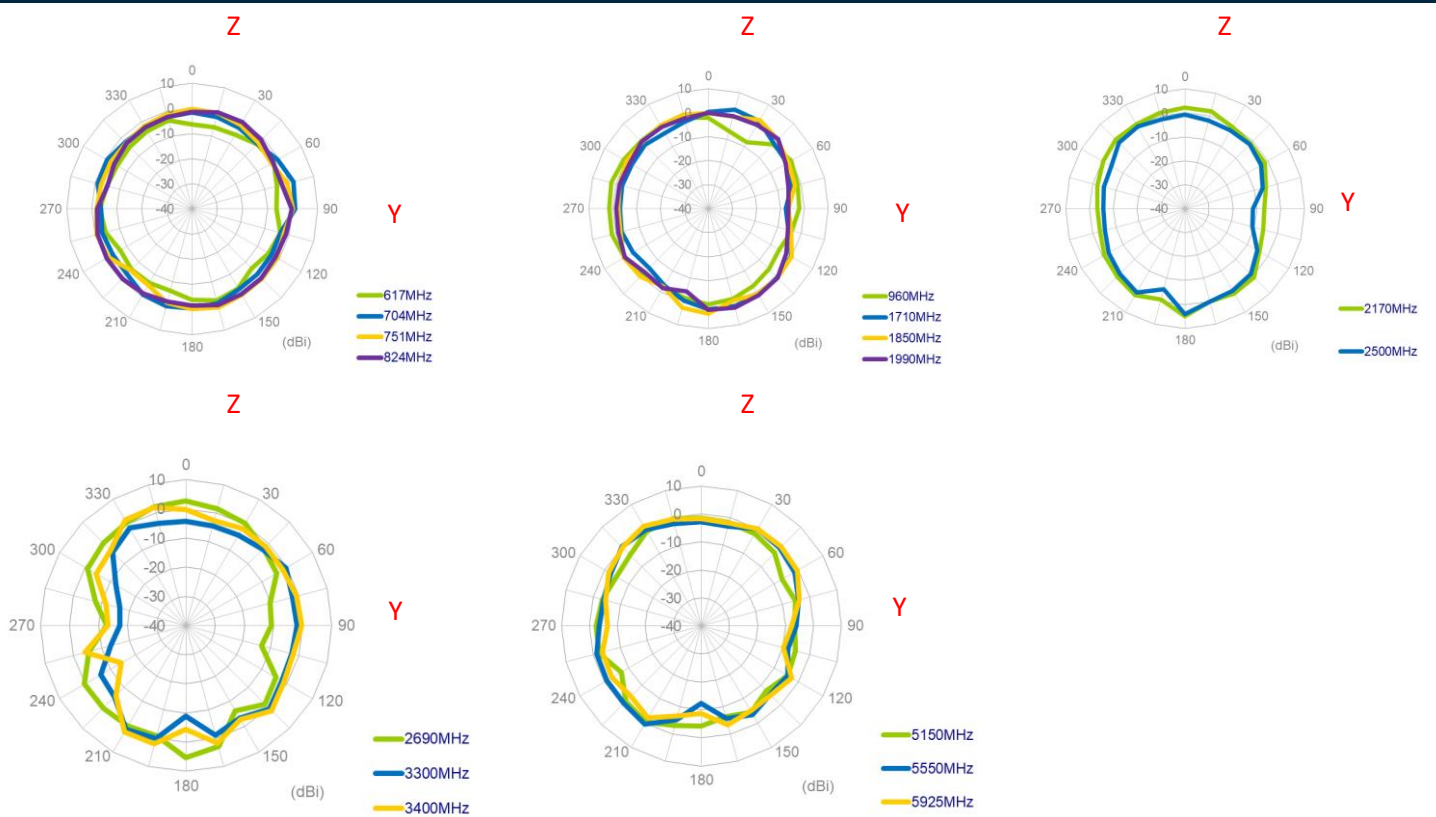

5.2.3 LTE MIMO3

XY Plane

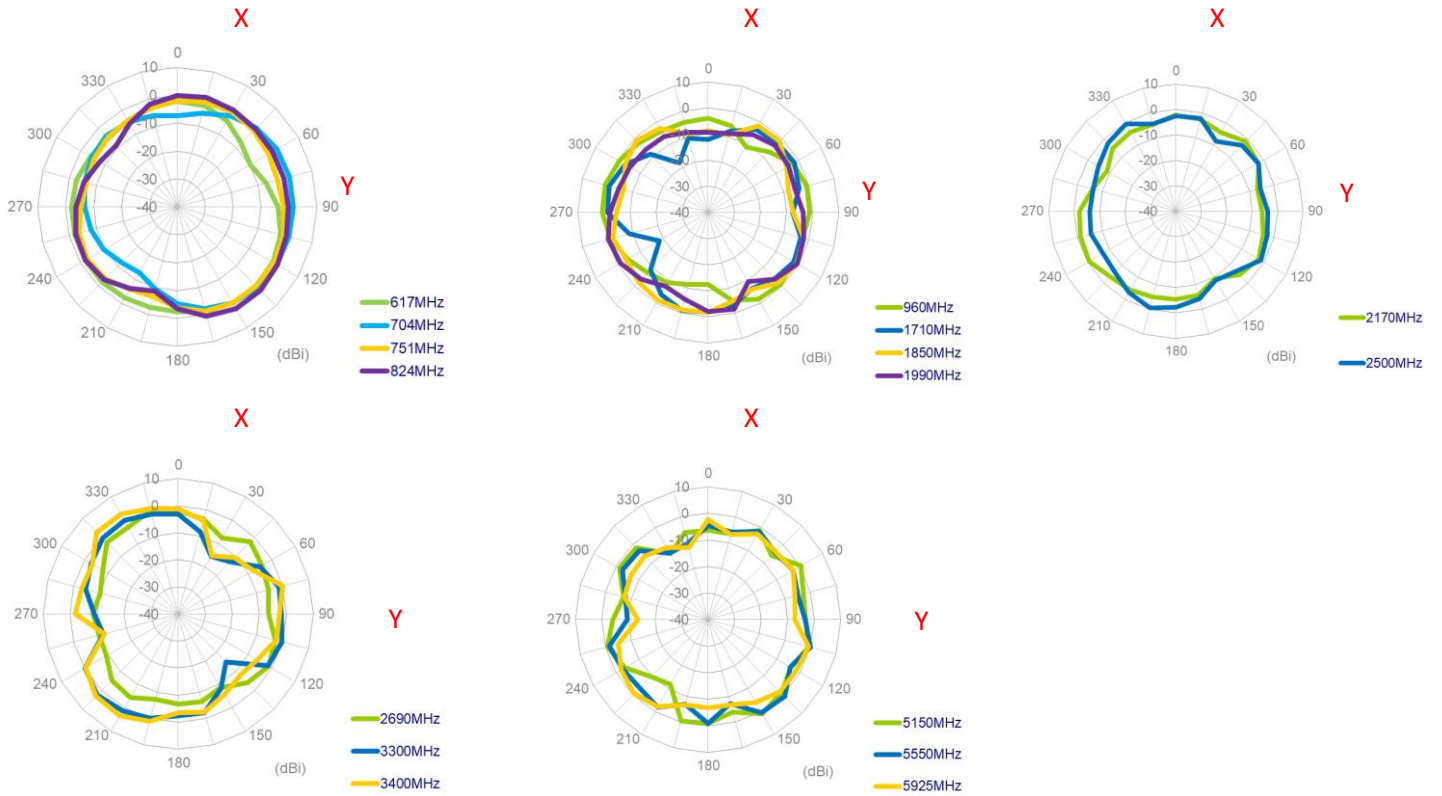

XZ Plane

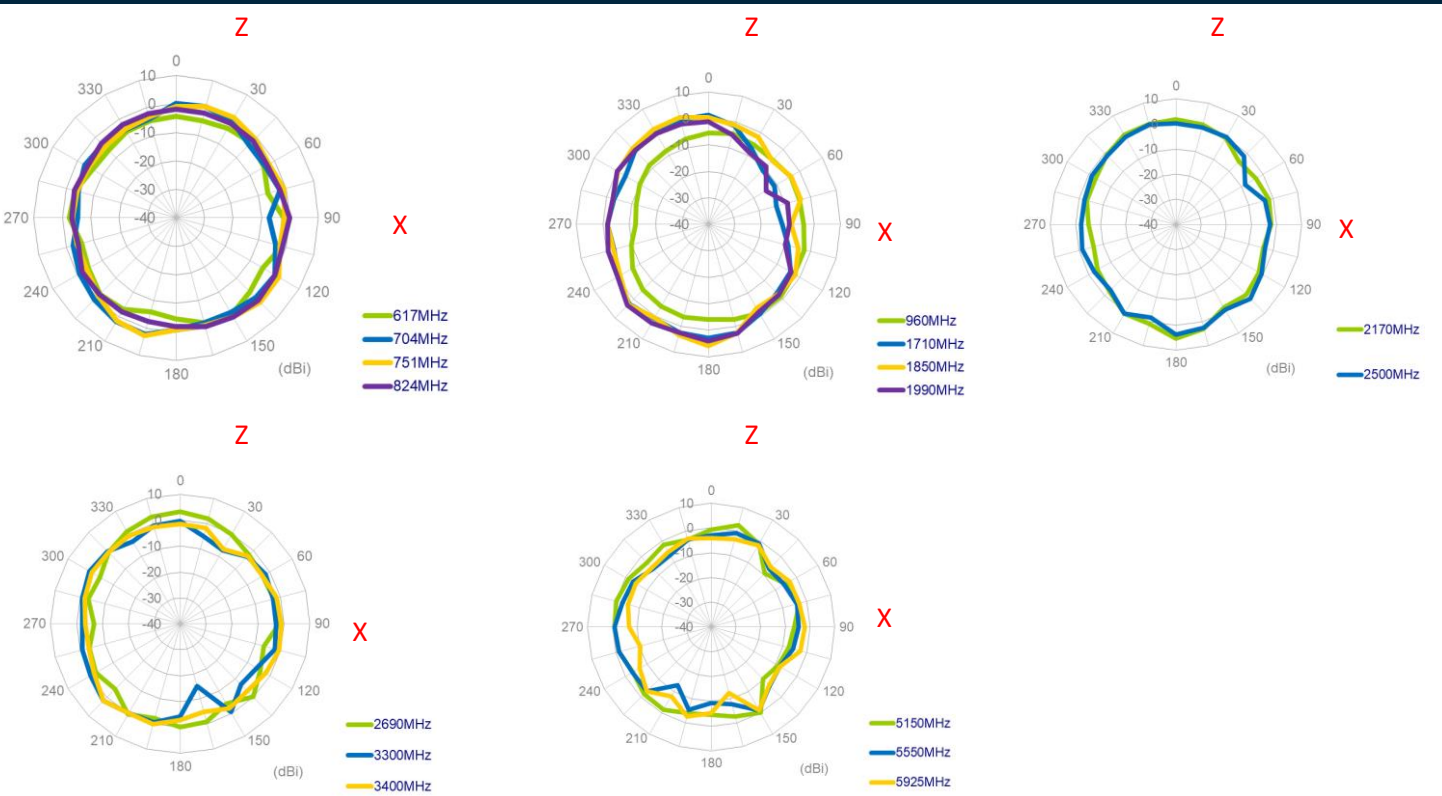

YZ Plane

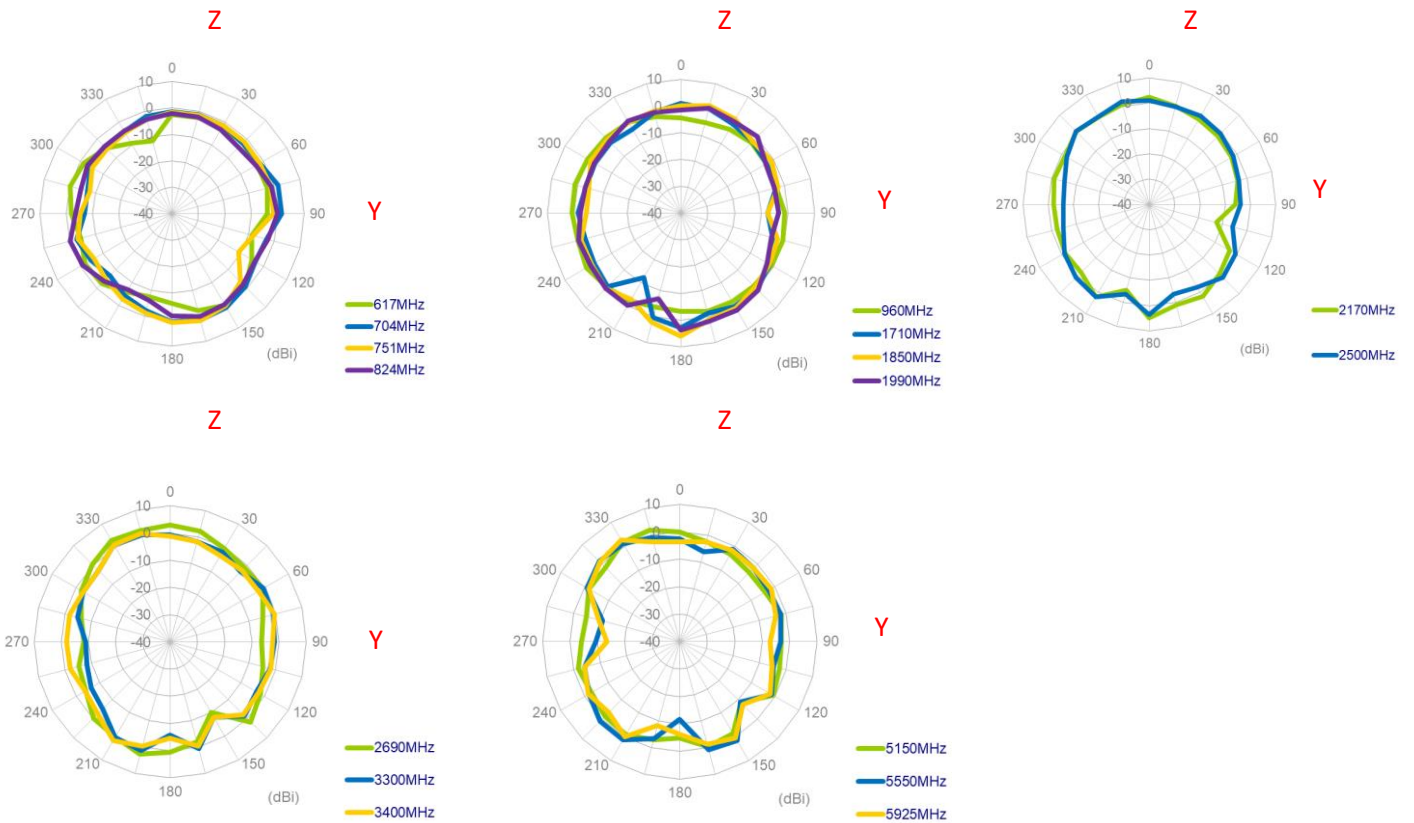

5.2.4 LTE MIMO4

XY Plane

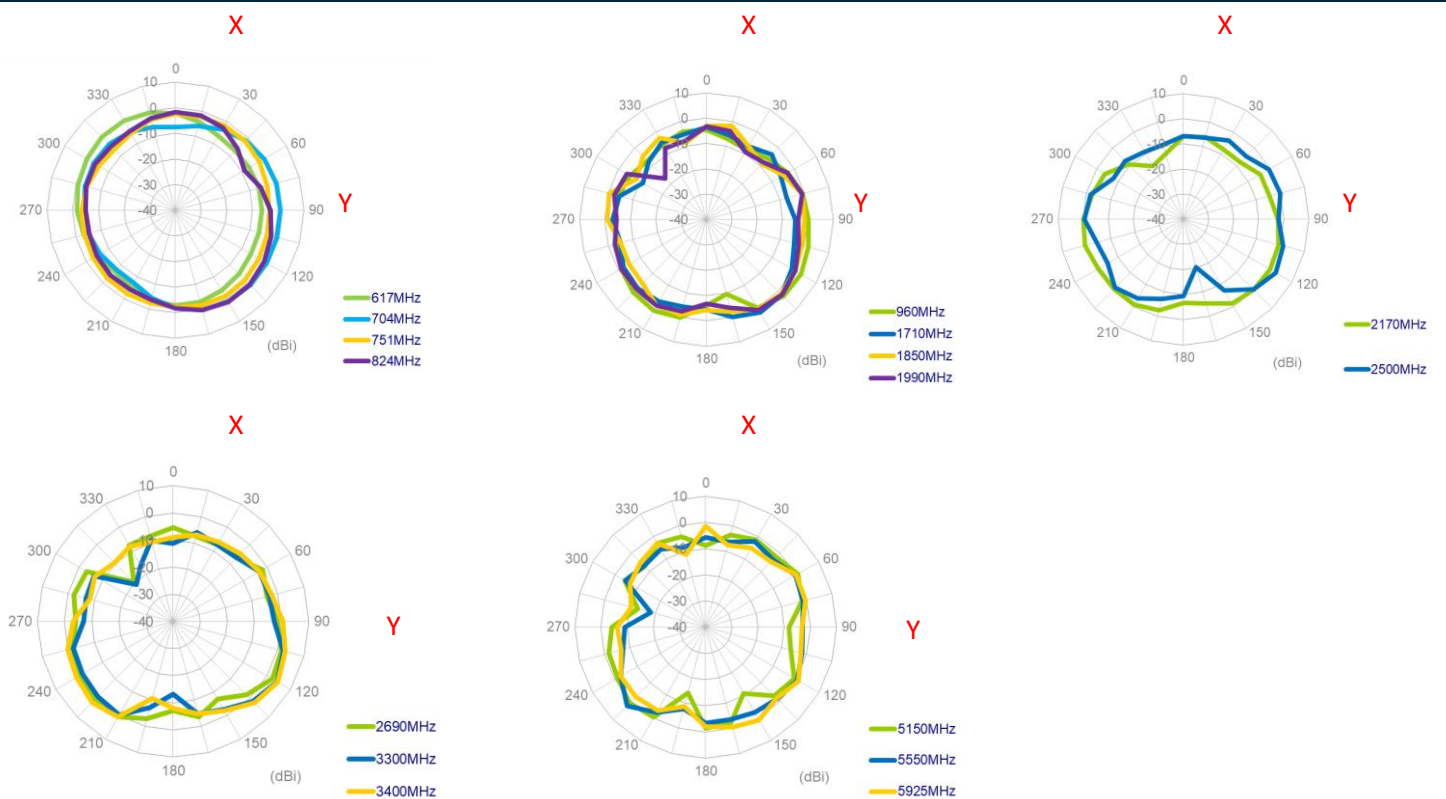

XZ Plane

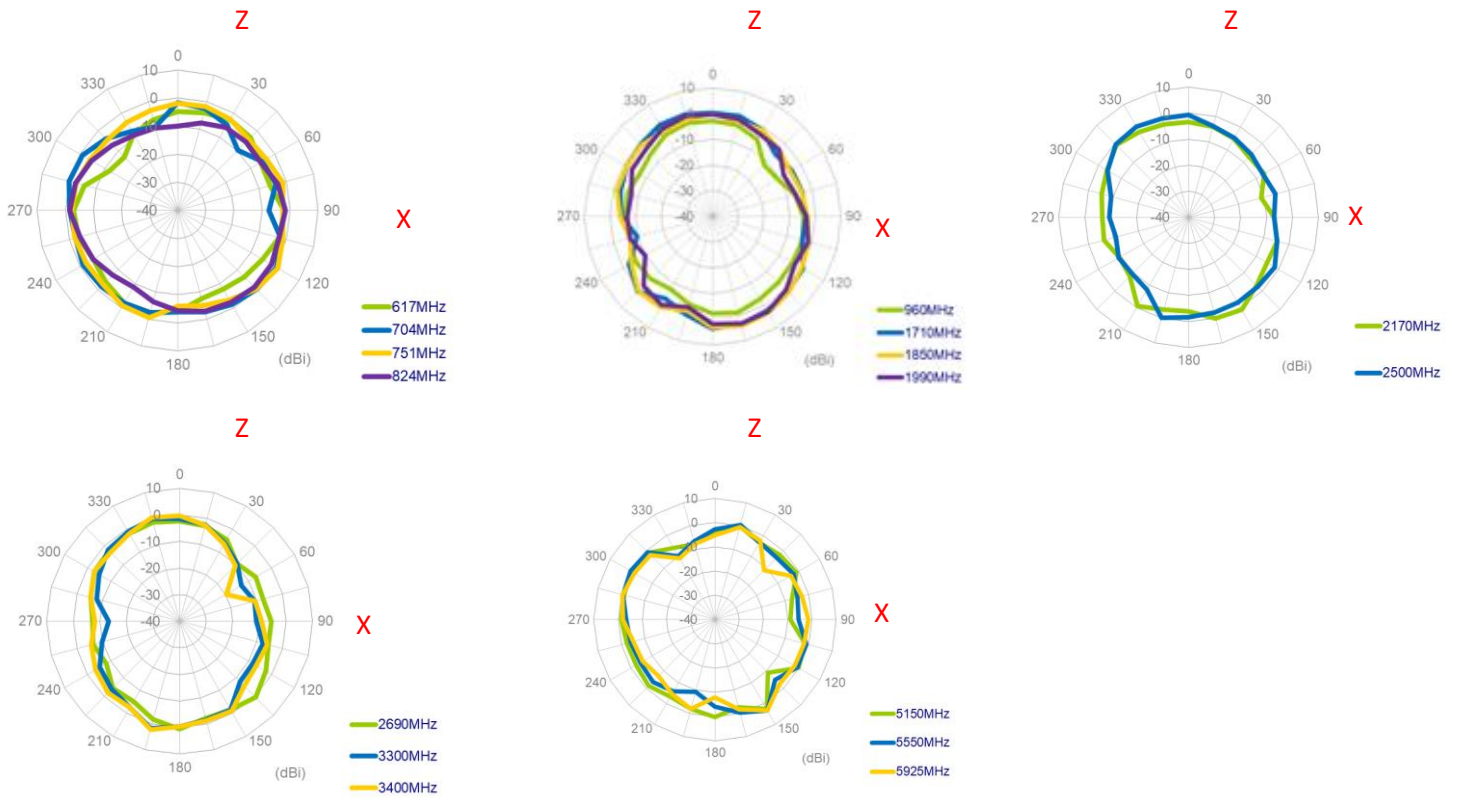

YZ Plane

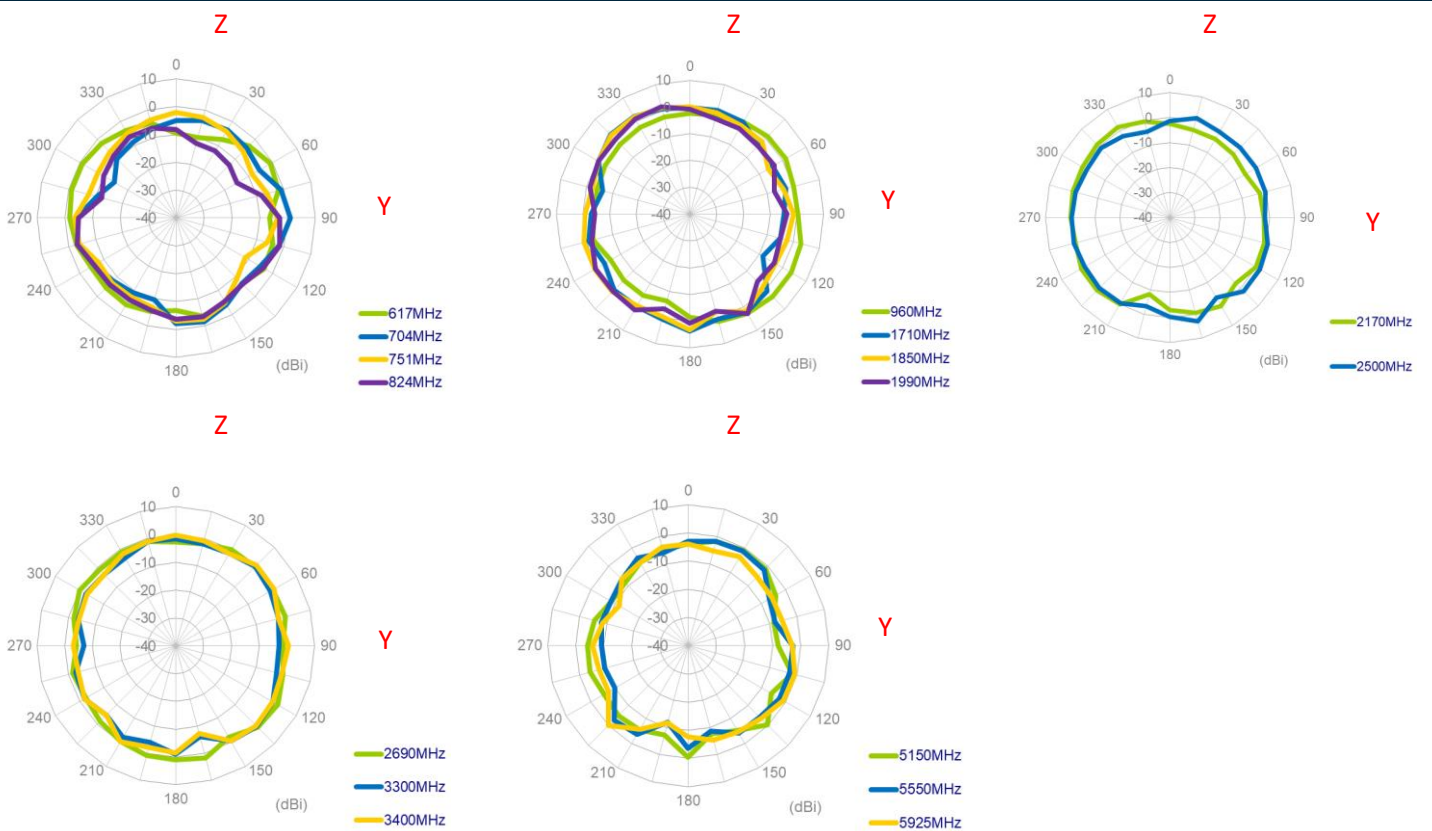

5.3 3D Radiation Pattern

5.3.1 LTE MIMO1

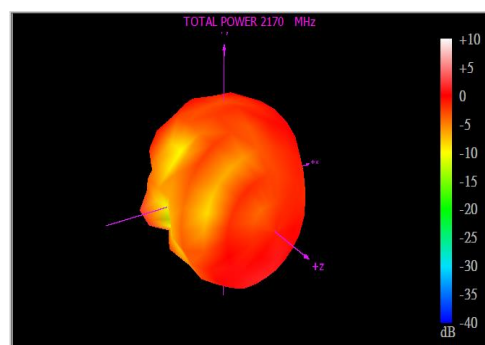
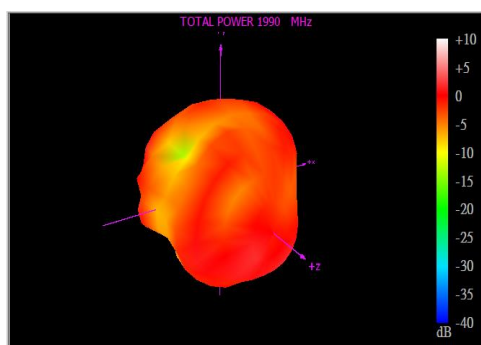
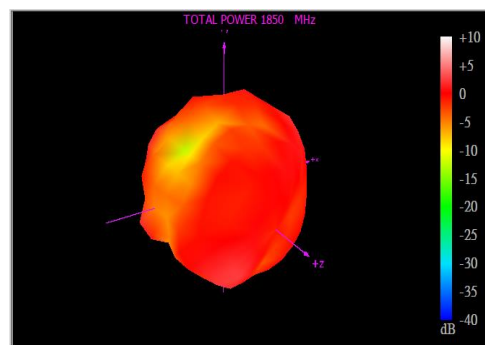
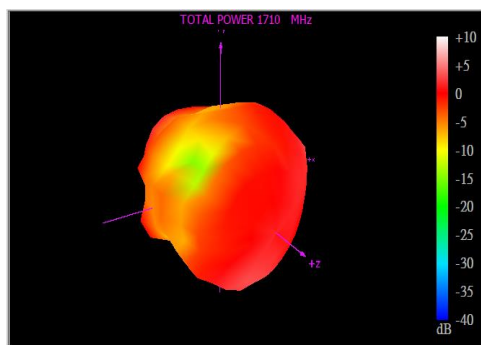
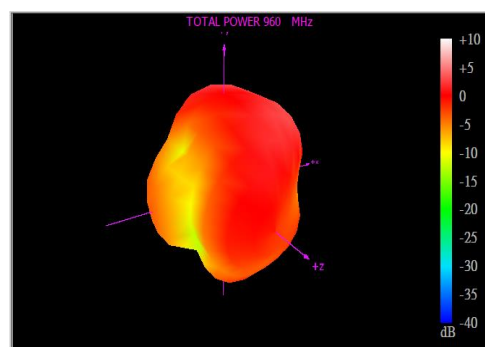
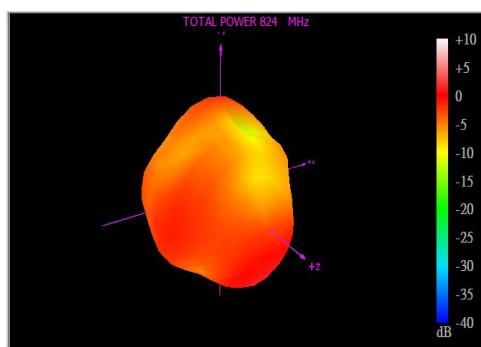
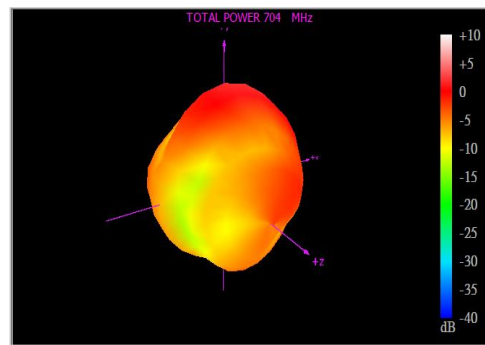
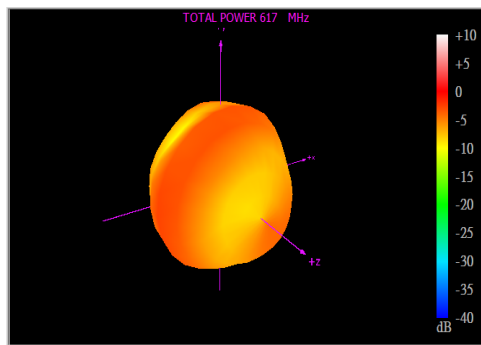

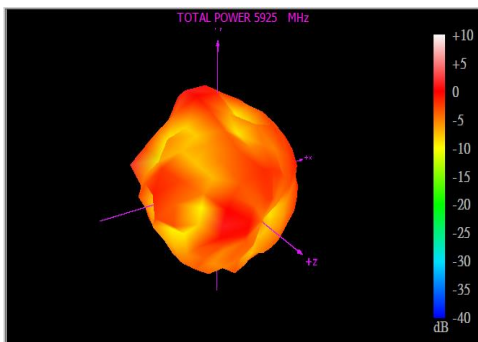
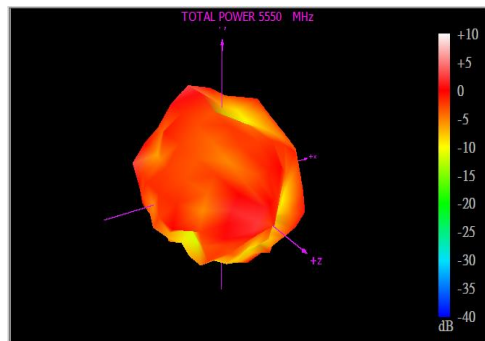
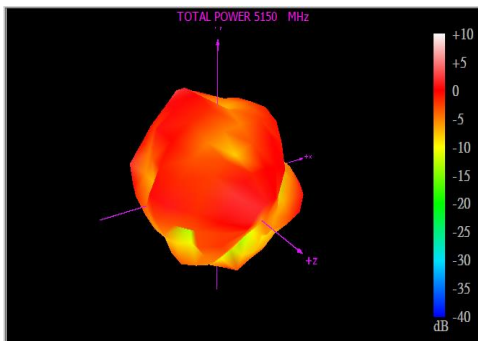
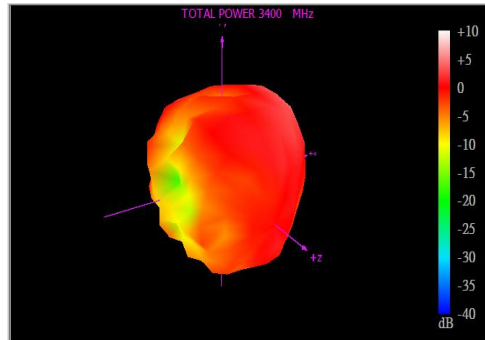
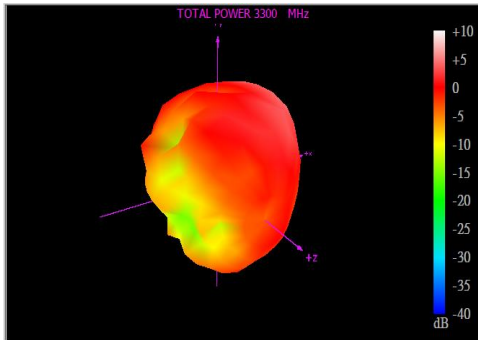
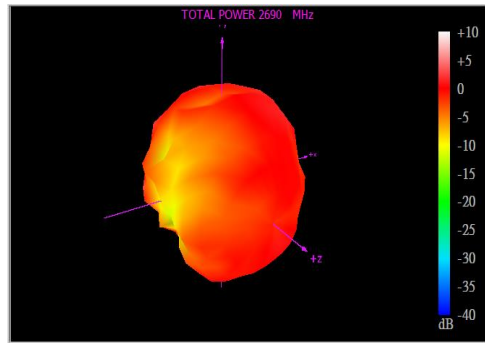
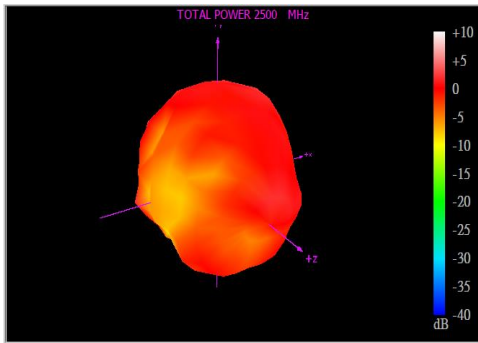

5.3.2 LTE MIMO2

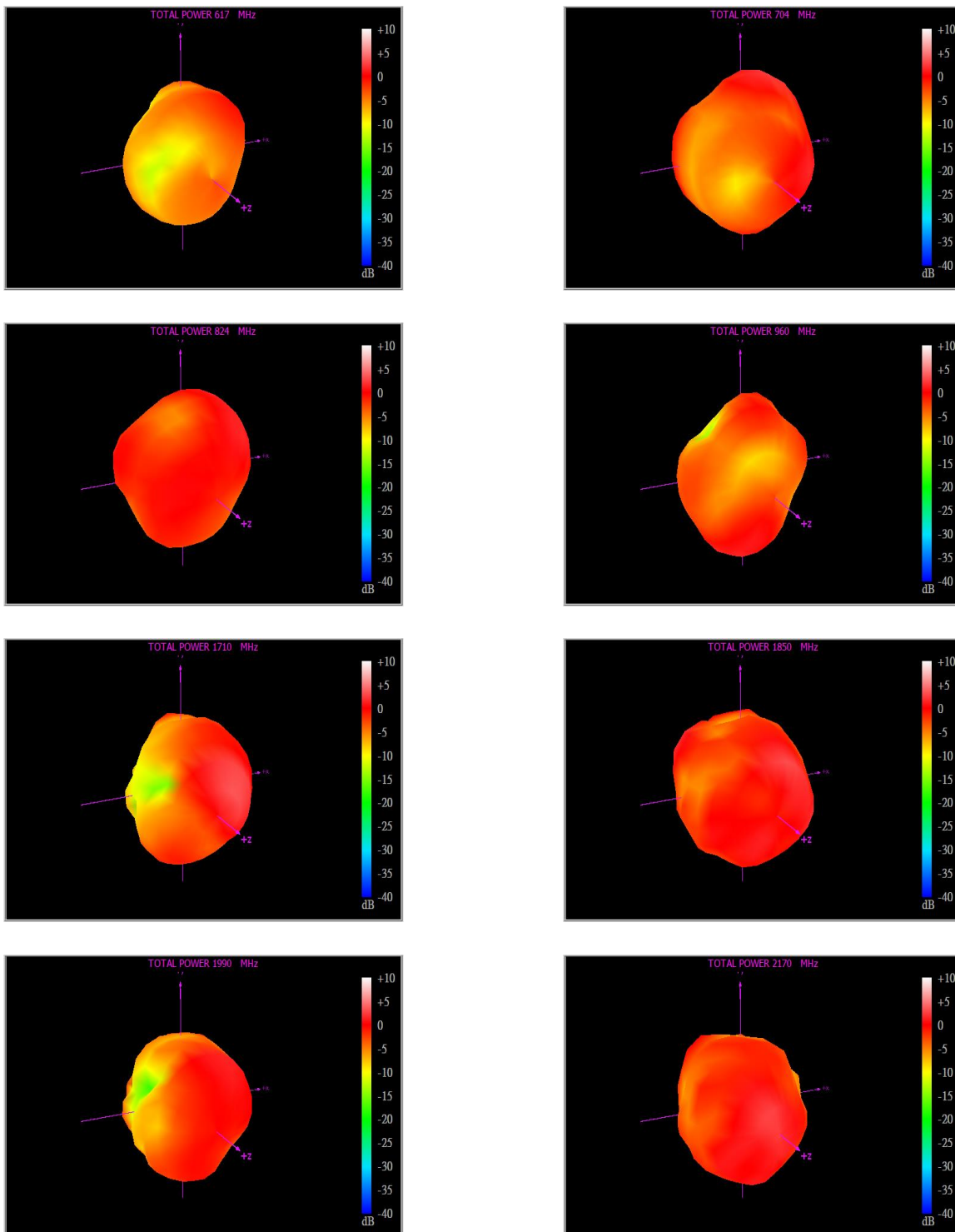

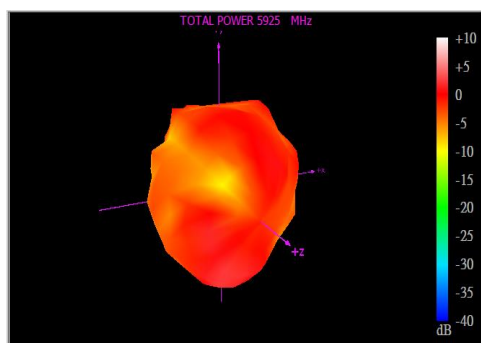
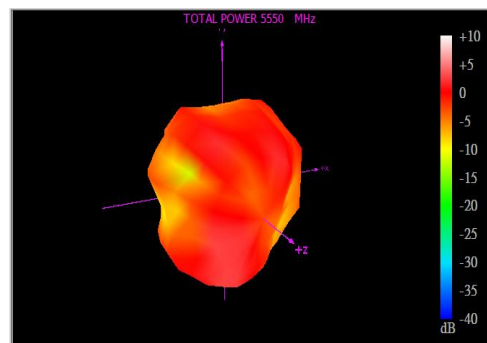
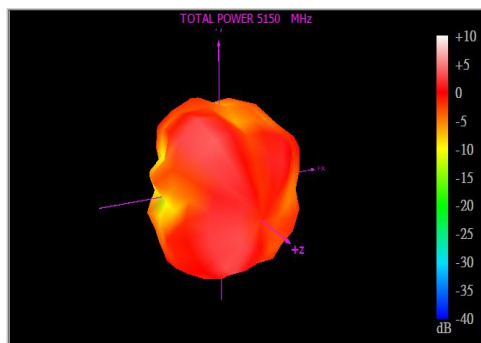
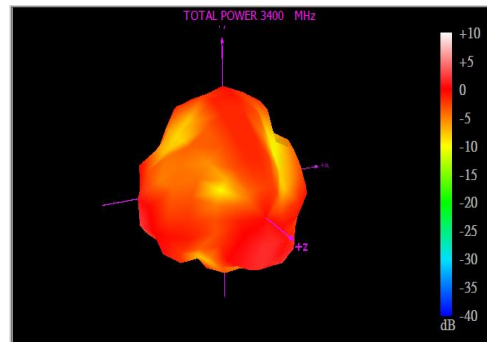
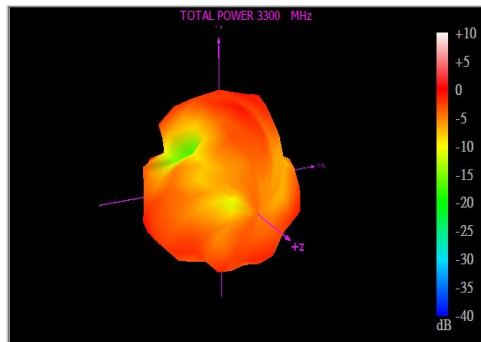
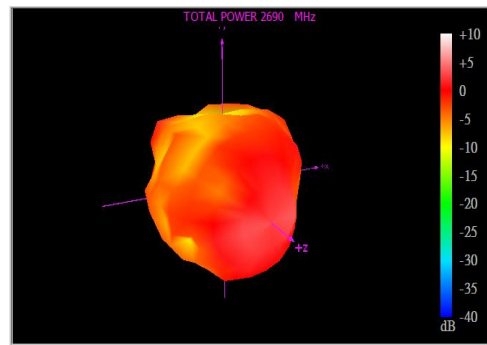
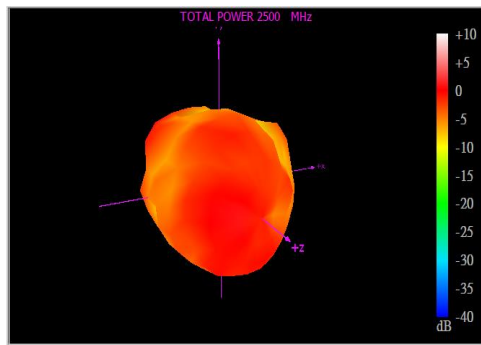

5.3.3 LTE MIMO3

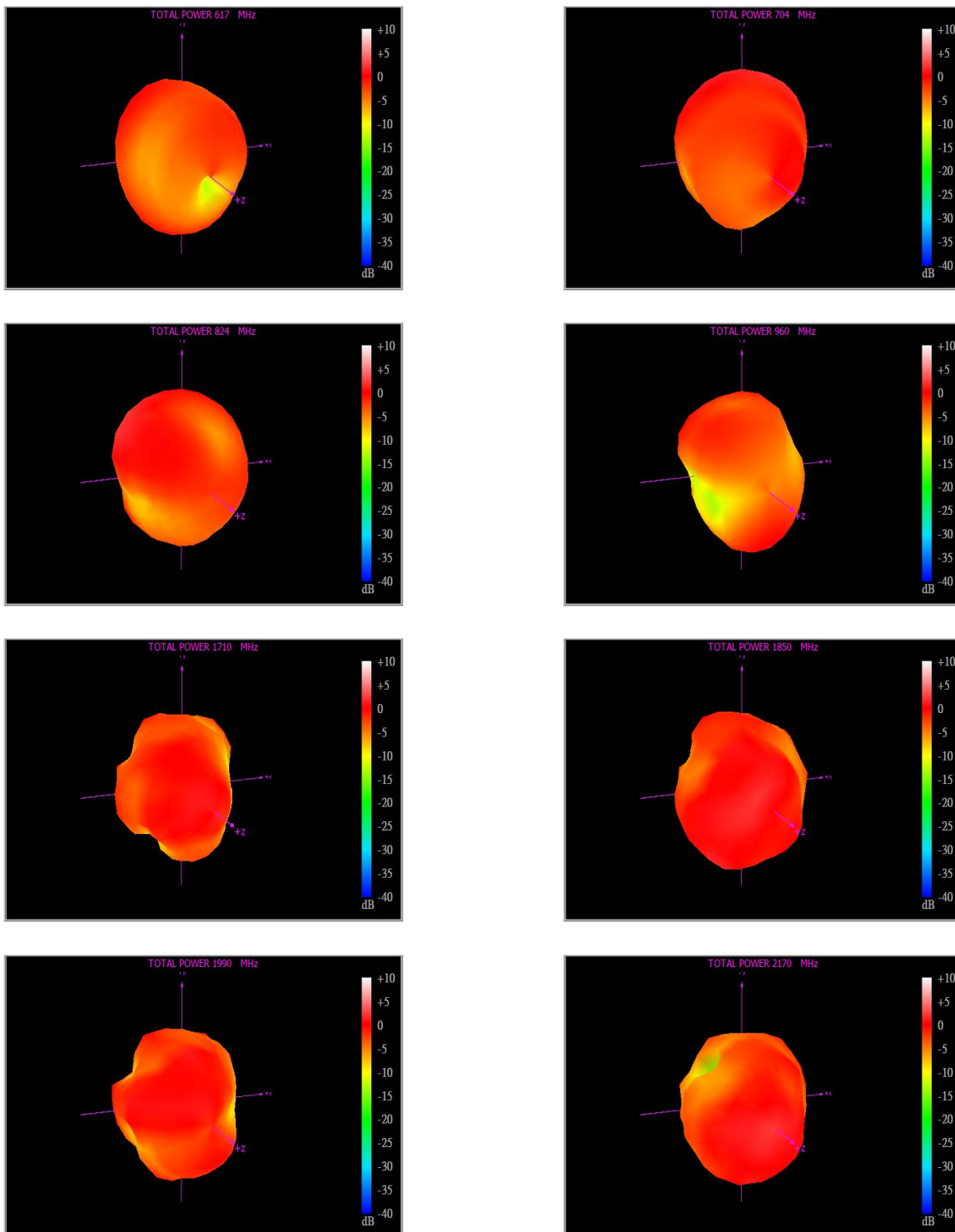

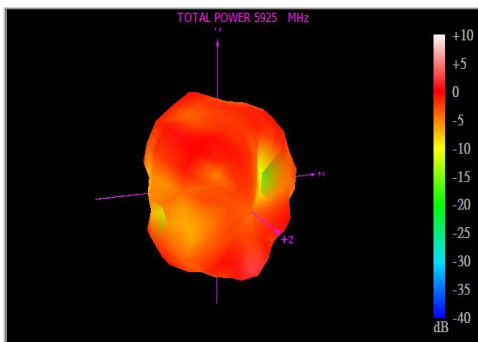
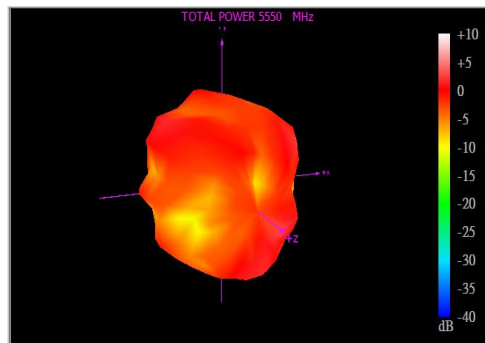
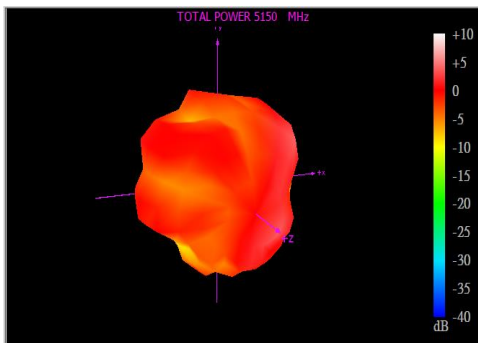
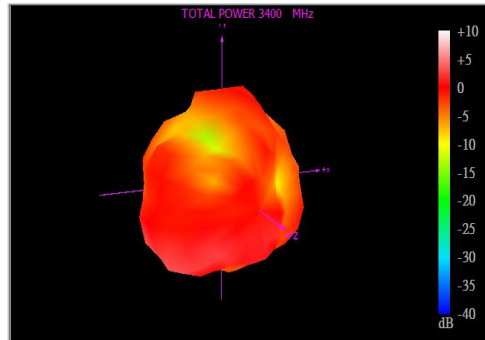
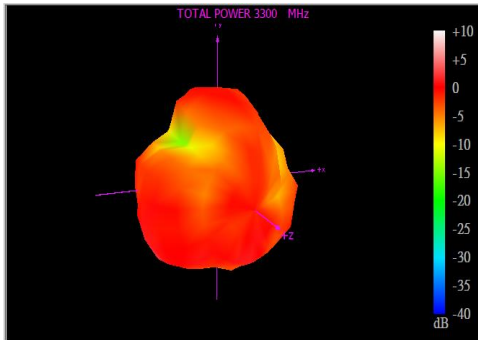
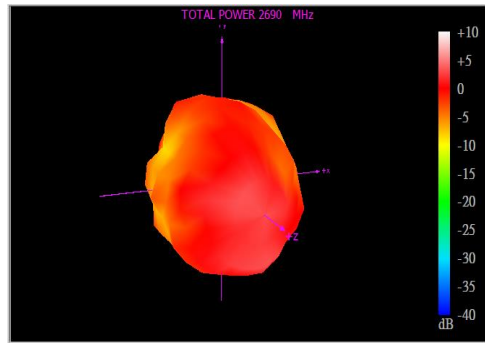
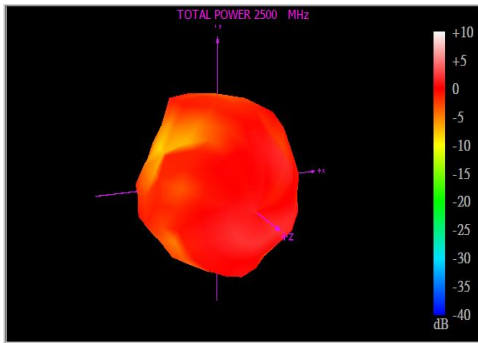

5.3.4 LTE MIMO4

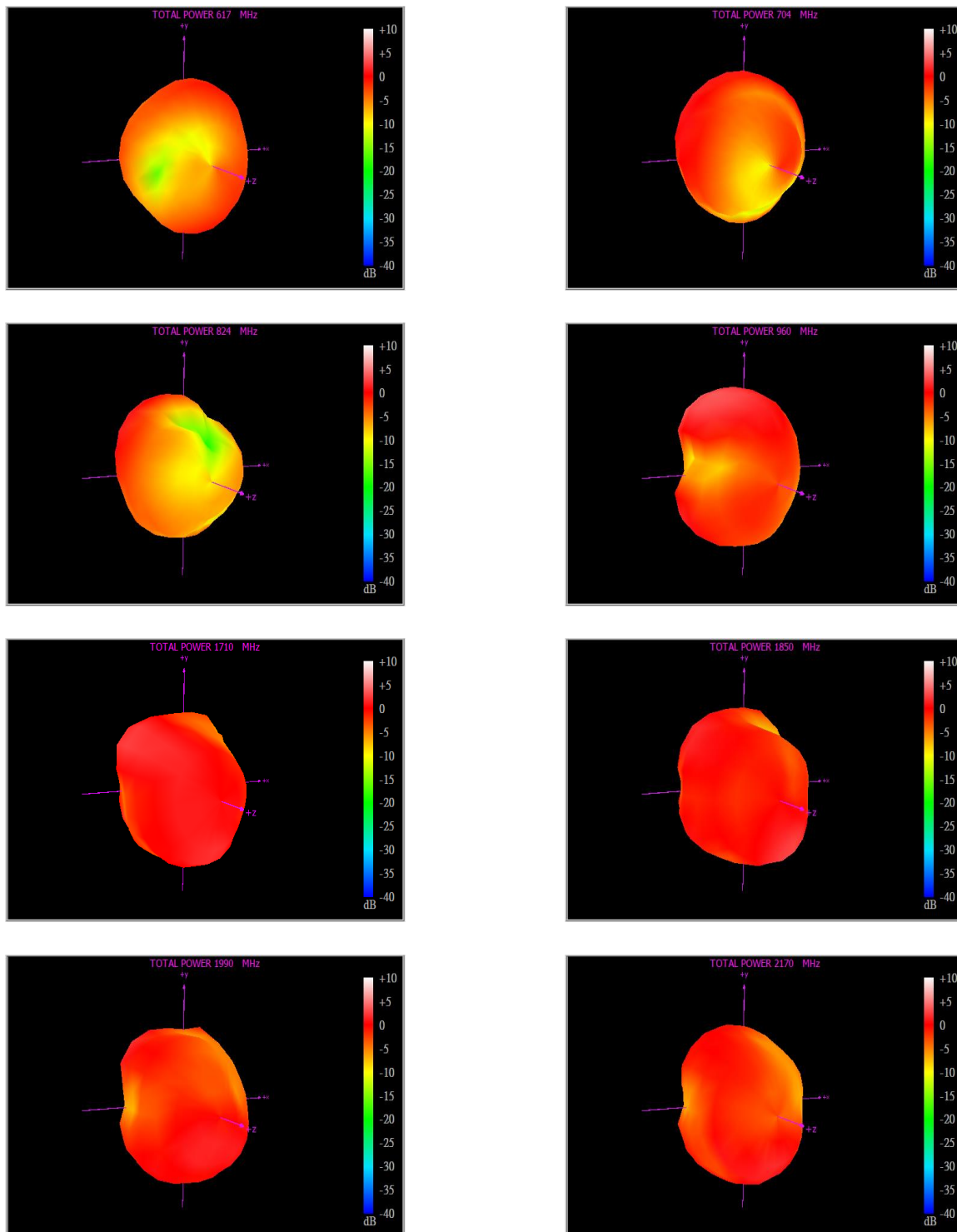

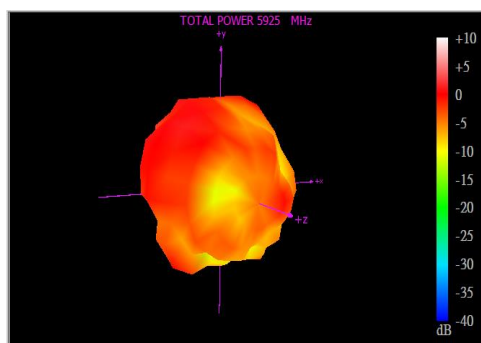
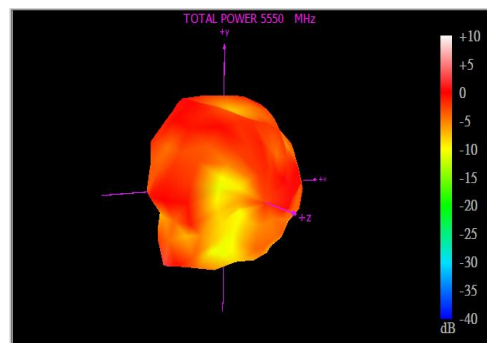
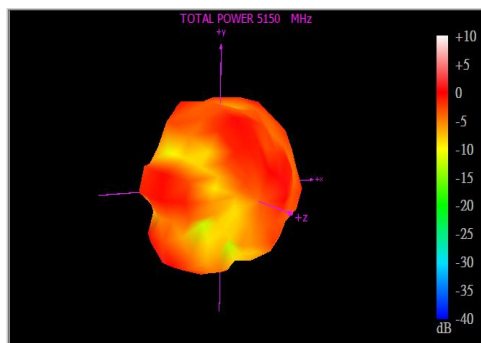
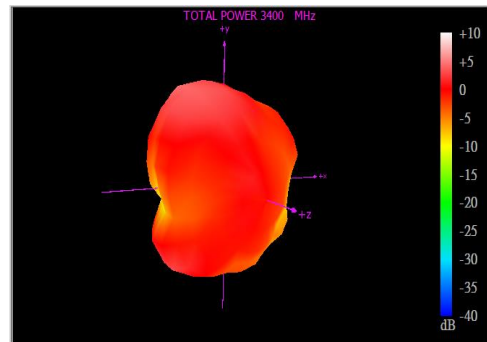
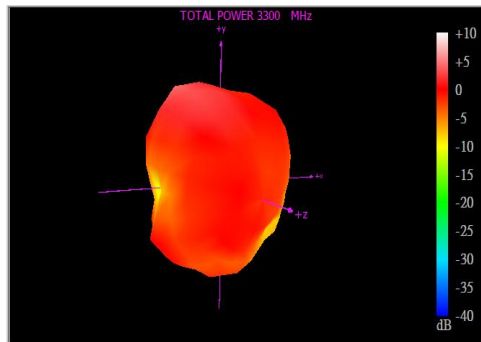
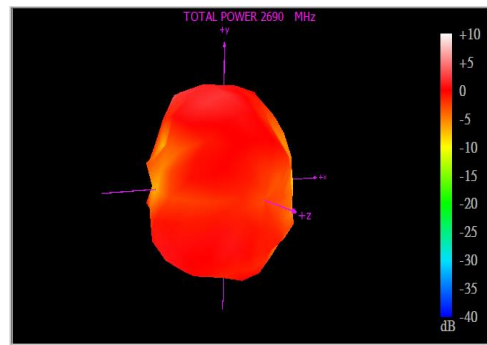
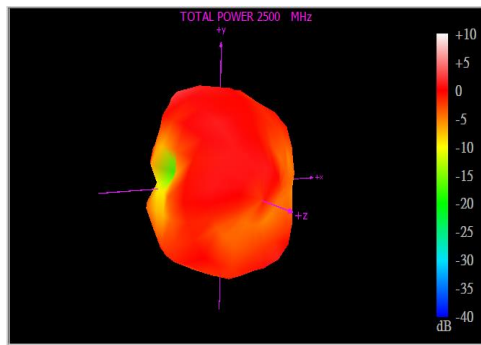

6. Mechanical Drawing (Units: mm)

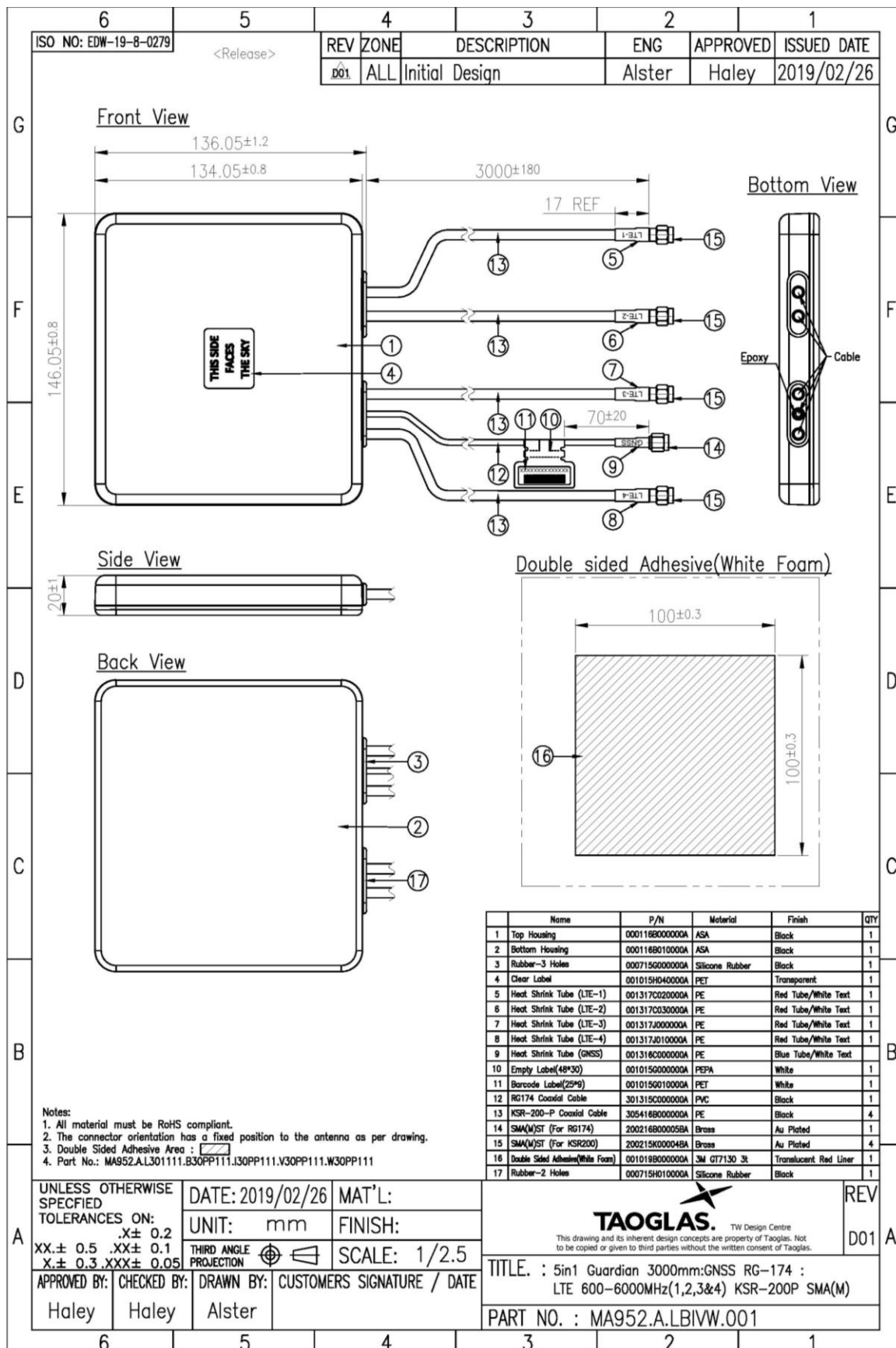

7. Packaging

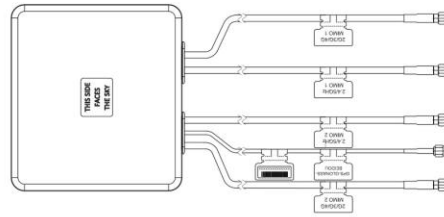

1 No. MA952.A.LBIVW.001 per small box
 Box Dimensions - 260*235*105mm
 Weight - 0.71Kg

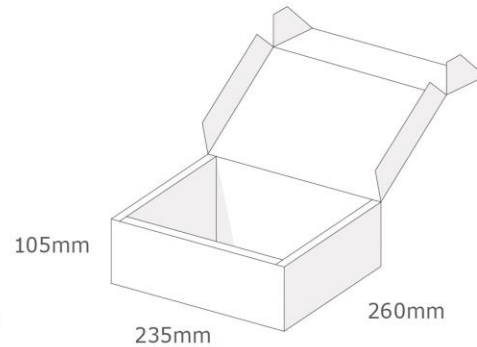

1 Outer Carton
 Carton Dimensions - 540*490*240mm
 8 pcs MA952.A.LBIVW.001 per carton
 Weight - 6.3Kg

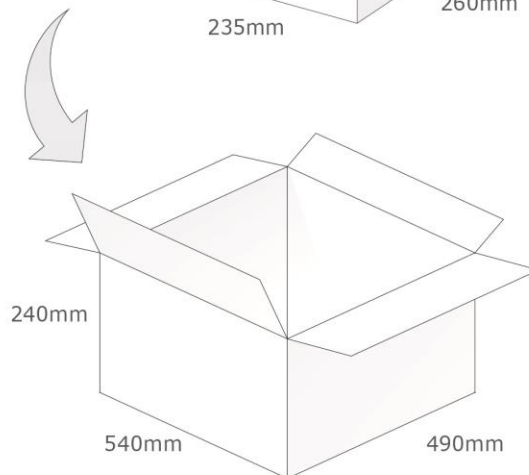

Pallet Dimensions 1200*1000*1400mm
 20 Cartons per Pallet
 4 Cartons per layer
 5 Layers

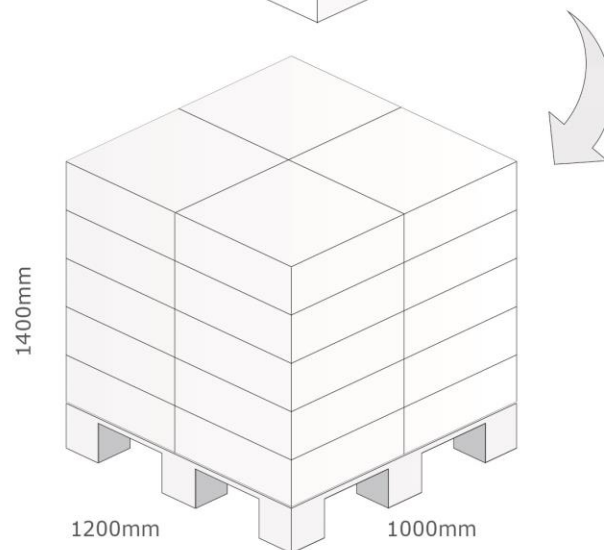

Changelog for the datasheet

SPE-19-8-054 – MA952.A.LBIVW.001

Revision: A (Original First Release)	
Date:	2019-04-19
Notes:	
Author:	Jack Conroy

Previous Revisions



TAOGLAS®

www.taoglas.com

