

PD30CTRR60BPxxIO - IO-Link



Photoelectric Retro-reflective sensors with IO-Link communication



Description

The PD30CTRR60BPxxIO are a part of the latest generation of high performance photoelectric sensors designed to solve most detection tasks due to the new IO-Link features.

The sensors are implemented in the compact 10 x 20 x 30 mm ABS housing that are acknowledged world wide.

New implemented functions with weight on functionality, reliability, Predictive maintenance make these sensors ideal for Industry 4.0.

Benefits

- **Retro-reflective** sensor with IO-Link with a adjustable distance of 1.7 to 6 m, either by trimmer or via IO-Link.
- **Application functions:** Pattern Recognition, Speed & Length, Divider function and Object & Gap Monitoring.
- **Neighbour Immunity**, selectable up to 3 sensors
- **Easy customization** to specific OEM requests by use of the build in IO-Link functionalities.
- **The output can be operated** either as a standard switching output or in IO-Link mode.
- **Fully configurable via output IO-Link v 1.1.** Electrical outputs can be configured as PNP / NPN / Push-Pull / External input, normally open or normally closed.
- **Timer functions** can be set, such as ON-delay, Off-delay, and one shots.
- **Logging functions:** Temperatures, detecting counter, power cycles and operating hours.
- **Detection modes** Single point, two point and windows mode.
- **Logic functions:** AND, OR, XOR and Gated SR-FF.
- **Analogue output:** In IO-Link mode the sensor will generate 16 bit analogue process data output representing various selectable process data such as received signal level.



Applications

Pattern Recognition: An easy way to verify that a product is manufactured to the specification e.g. Furniture production where tabs or holes has to be with a defined pattern.

Speed and Length: Monitor the speed and length of an object on a conveyour for e.g. sorting on size.

Divider function: A de-central counting function that gives a signal when a preset count level is reached e.g. when a certain items are packed in a carton box it ask for a new box.

Object and Gap Monitoring: Function that can sort out good objects and gaps between them so e.g. a packaging machine only receive objects with the correct size and gaps.

Main functions

- Detects presence or absence of objects that cut off the light from the emitter
- Detects all opaque objects very reliably
- The sensor can be operated in IO-Link mode once connected to an IO-Link master or in standard I/O mode.
- Received light intensity as process data.



- Neighbor inference protection.
- Sensing distance by potentiometer, teach by wire or by IO-link parameter.
- Quality of Run and Quality of Teach result.
- Temperature date for preventive maintenance.
- Front-end check for preventive maintenance.

Adjustable parameters via IO-Link interface:

- Sensing distance and hysteresis.
- Sensing modes: single point or two point or window mode.
- Timer functions, e.g.: On-delay, Off delay, One shot leading edge or trailing edge.
- Logic functions such as: AND, OR, X-OR and SR-FF.
- External input.
- Logging functions: Maximum temperatures, minimum temperatures, operating hours, operating cycles, power cycles, minutes above maximum temperature, minutes below minimum temperature, etc.
- Auto hysteresis
- Special functions: Pattern Recognition, Speed & Length, Divider function and Object & Gap Monitoring.

References

Product selection key

PD30CTRR60BP IO

Enter the code option instead of

Code	Option	Description
P	-	Sensing principle: Photoelectric sensor
D	-	Rectangular housing
30	-	Length of housing
C	-	Plastic housing
T	-	Top trimmer
R	-	Retro-reflective
R	-	Red light
60	-	Sensing distance: 6 m
B	-	Selectable functions: NPN, PNP, Push-Pull, External Input (only pin 2) or External teach input (only pin 2)
P	-	Selectable: N.O. or N.C.
<input type="checkbox"/>	A2	Cable, 2 m
	M5	Connector M8
IO	-	IO-Link version

Type selection

Connec-tion	Housing	Light type	Code
Cable	Plastic housing	Red	PD30CTRR60BPA2IO
Plug	Plastic housing	Red	PD30CTRR60BPM5IO



Structure

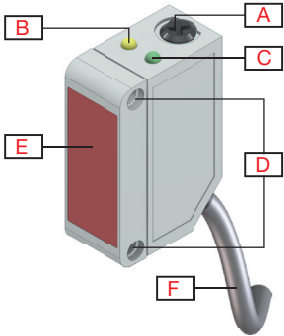

Fig. 1 Cable

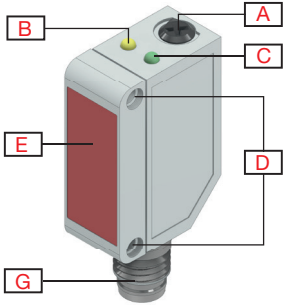

Fig. 2 Plug

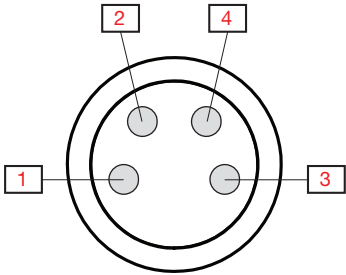

Fig. 3 "M8-plug" Pin numbers

A	Sensitivity adjustment (Top trimmer)	G	M8, 4-pin male connector
B	Yellow LED	1	Brown
C	Green LED	2	White
D	M3 Fixing holes for sensor mounting	3	Blue
E	Sensing window	4	Black
F	2 m, 4 wire PVC Ø 3.3 mm cable		



Sensing

Detection

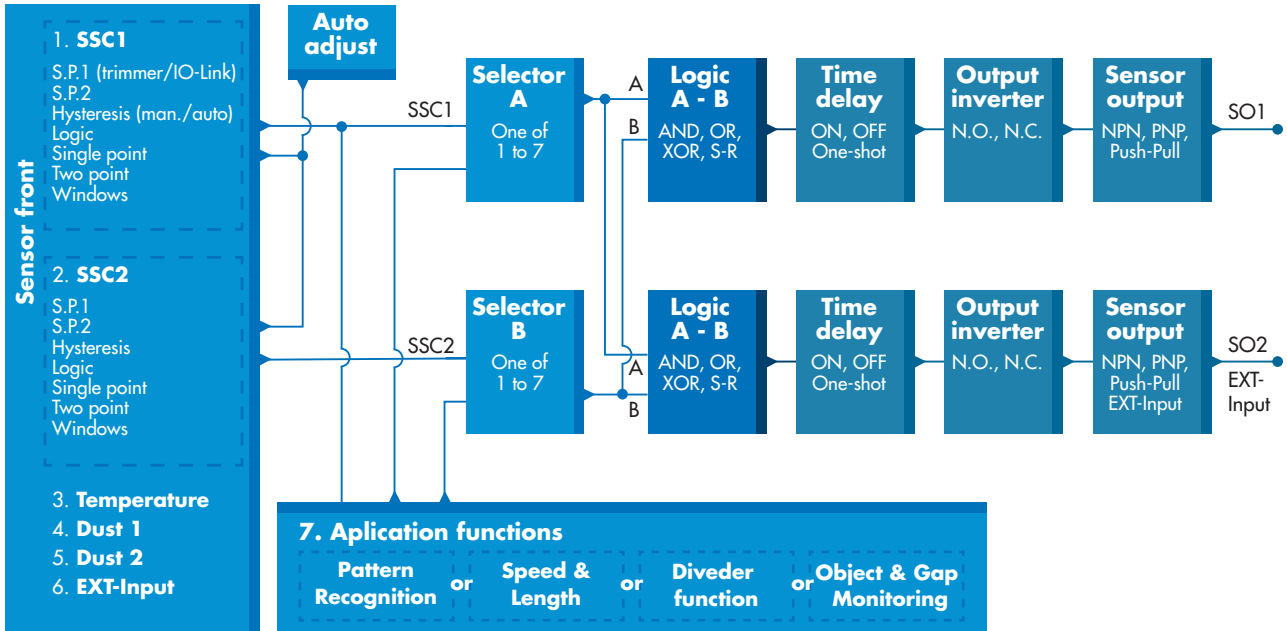



Sensor switching channel SSC1 and SSC2	SSC1 <ul style="list-style-type: none"> • Enabled • Disabled Factory settings: Enabled	SSC2 <ul style="list-style-type: none"> • Enabled • Disabled Factory settings: Enabled
Set Point 1 (SP1)	<ul style="list-style-type: none"> • 0 ... 1 500 Factory settings: 100 (Approx. 6 m @ Reference target, reflector: ER4 (Ø80 mm))	
Set Point 2 (SP2)	<ul style="list-style-type: none"> • 0 ... 1 500 Factory settings: 1 500 (Approx. 1.7 m @ Reference target, reflector: ER4 (Ø80 mm))	
Switching logic	<ul style="list-style-type: none"> • High active • Low active Factory settings: High active	
Switching mode	SSC1 <ul style="list-style-type: none"> • Deactivated • Single point mode • Two point mode • Windows mode Factory settings: Single point mode	SSC2 <ul style="list-style-type: none"> • Deactivated • Single point mode • Two point mode • Windows mode Factory settings: Single point mode
Rated operating distance (S_n)	≤ 6 m	@ Reference target, reflector: ER4 (Ø80 mm)
	≤ 4 m	@ Reference target, reflector: ER4060
Maximum detection distance	< 6 m	@ Reference target, reflector: ER4 (Ø80 mm)
Sensitivity control (selectable between)	<ul style="list-style-type: none"> • IO-Link Adjustment (SSC1) • Trimmer Input (SSC1) • Teach by wire (SSC1) Factory settings: Trimmer Input	
Sensitivity adjustment	70 ... 1 200	Single-turn potentiometer
Blind zone	≤ 100 mm @ S _n max	@ reflector ER4, Ø80 or ER4060
Light source / Light type	620 nm / Red modulated	
Detection angle	± 1.5°	@ 3.0 m (half sensing distance)
Light spot size	Ø 15 cm	@ 3.0 m (half sensing distance)
Emitter beam angle	± 1.5°	@ 3.0 m (half sensing distance)
Adjustable distance	<ul style="list-style-type: none"> • 0 ... 1 500 Factory settings: SP1 100 (6 m) and SP2 1 500 (1.7 m)	@ Reference target, reflector: ER4 (Ø80 mm)
Hysteresis (H)	Adjustable by IO-Link	
Manual	• 1% ... 100%	
Automatic	Typical 5% ... 10% / Max. 15%	
Detection filter	This function can increase the immunity towards unstable targets and electromagnetic disturbances: Value can be set from 1 to 255. Factory settings: 1 (1 is max. operating frequency and 255 is min. operating frequency)	
Mutual Inteferece Protection	<ul style="list-style-type: none"> • MIP Off • One channel • 2 channels - CH A • 2 channels - CH B • 3 channels - CH A • 3 channels - CH B • 3 channels - CH C 	Factory settings: MIP Off

Application functions

Selectable dedicated applications	<ul style="list-style-type: none"> • No application • Pattern Recognition • Speed and Length • Divider function • Object and Gap Monitoring 	Factory settings: No application
--	--	---

Pattern Recognition

Function description	The Pattern recognition function detects a pattern (e.g. a row of holes or pins) and compare the order with a pre-taught reference pattern.	
Conditions	Two sensors (Main sensor and Trigger sensor) are needed for this function.	
Settings	<ul style="list-style-type: none"> • The Trigger sensor has to detect the full length of the body that contains the pattern. • The Main sensor has to be aimed at the e.g. holes or pins that constitute the pattern. 	

Speed and Length

Function description	This function is designed to monitor the length of an object as well as the speed of a conveyour belt. The actual value if the length in [mm] and the speed in [mm/s] are directly available on the IO-Link master.	
Conditions	Two sensors (Main sensor and Trigger sensor) are needed for this function.	
Settings	Distance between sensors.	25 ... 150 mm Factory settings: 100 mm

Divider function

Function description	This function can be used to e.g. monitor how many items that are packed into a carton box. Once the preset number is reached the sensor gives an output so the full box can be replaced.	
Conditions	Only one sensor is needed for this function.	
Settings	A counter value must be set in the sensor.	
	Counter limit.	1...60 000 Factory settings: 5



Object and Gap Monitoring

Function description	This function is designed to monitor, that the length of an object and the gap between the following object on a conveyer belt, are within certain limits.	
Conditions	Only one sensor is needed for this function.	
Settings	An acceptable minimum and maximum time [ms] must be set for both the object size a gap size between two objects represented by the time it takes to pass the sensor.	
	Object minimum time.	10...60 000 ms Factory settings: 500 ms
	Object maximum time.	10...60 000 ms Factory settings: 10 000 ms
	Gap minimum time.	10...60 000 ms Factory settings: 500 ms
	Gap maximum time.	10...60 000 ms Factory settings: 10 000 ms
Outputs	Output 1 is active when an object is outside the set limits. Output 2 is active when the gap between two objects is outside the set limits.	

Alarm settings

Safe limits	SSC1 • 0 ... 100 % of actual SP Factory settings: 20%	SSC2 • 0 ... 100 % of actual SP Factory settings: 20%
Dust alarm	Safe limits are used for dust alarm level.	
Water drop alarm	Safe limits are used for water drop alarm level.	
Temperature alarm	<ul style="list-style-type: none"> • High threshold -50 ... +150 °C • Low threshold -50 ... +150 °C Factory settings: High value 70 °C Low value -20 °C	

Detection diagram

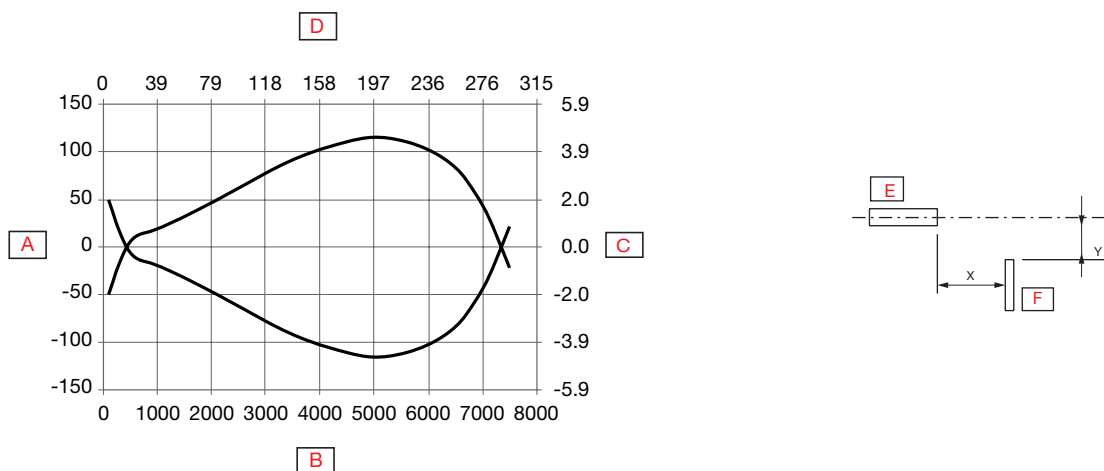

A	Detection width (mm)	D	Sensing range (inches)
B	Sensing range (mm)	E	Sensor
C	Detection width (inches)	F	ER4 reflector



Accuracy

Temperature drift	≤ 0.2%/°C
-------------------	-----------

Excess gain

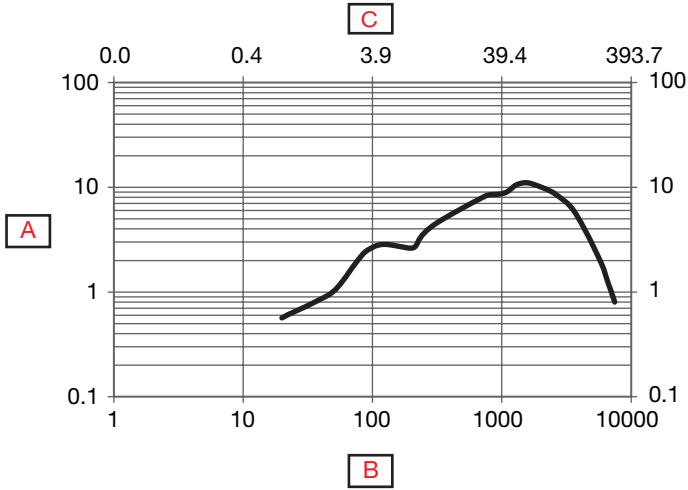

A	Excess gain	C	Distance (inches)
B	Distance mm		



Features

▶ Power Supply

Rated operational voltage (U_B)	10 ... 30 VDC (ripple included)
Ripple (U_{rpp})	≤ 10%
No load supply current (I_o)	≤ 30 mA @ U_B min. ≤ 15 mA @ U_B max.
Power-ON delay (t_v)	≤ 150 ms

▶ Auto adjust

Auto adjust	SSC1 • ON • OFF <i>Factory settings: OFF</i>	SSC2 • ON • OFF <i>Factory settings: OFF</i>
-------------	--	--

▶ Input selector

Input selector	Channel A • Deactivated • SSC1 • SSC2 • Dust alarm 1 • Dust alarm 2 • Temperature alarm • External input • Application functions <i>Factory settings: SSC1</i>	Channel B • Deactivated • SSC1 • SSC2 • Dust alarm 1 • Dust alarm 2 • Temperature alarm • External input • Application functions <i>Factory settings: SSC1</i>
----------------	--	--

▶ Logic functions

Logic functions	Channel A + B for SO1 • Direct • AND • OR • X-OR • SR-FF <i>Factory settings: Direct</i>	Channel A + B for SO2 • Direct • AND • OR • X-OR • SR-FF <i>Factory settings: Direct</i>
-----------------	---	---



Time delays

Timer mode	For SO1 <ul style="list-style-type: none"> • Disabled • ON delay • OFF delay • ON delay and OFF delay • One-shot leading edge • One-shot trailing edge Factory settings: Disabled	For SO2 <ul style="list-style-type: none"> • Disabled • ON delay • OFF delay • ON delay and OFF delay • One-shot leading edge • One-shot trailing edge Factory settings: Disabled
Timer scale	For SO1 <ul style="list-style-type: none"> • [ms] • [s] • [min] Factory settings: ms	For SO2 <ul style="list-style-type: none"> • [ms] • [s] • [min] Factory settings: ms
Timer value	For SO1 <ul style="list-style-type: none"> • 0 ... 32 767 Factory settings: 0	For SO2 <ul style="list-style-type: none"> • 0 ... 32 767 Factory settings: 0

Outputs

Sensor output	For SO1 Pin 4 Black wire <ul style="list-style-type: none"> • Disabled output • NPN • PNP • Push-Pull Factory settings: PNP	For SO2 Pin 2 White wire <ul style="list-style-type: none"> • Disabled output • NPN • PNP • Push-Pull • External input, active high • External input, active low • External teach • Mute input Factory settings: PNP
Output Inverter	For SO1 Pin 4 Black wire <ul style="list-style-type: none"> • N.O. • N.C. Factory settings: N.O.	For SO2 Pin 2 White wire <ul style="list-style-type: none"> • N.O. • N.C. Factory settings: N.C.
Rated operational current (I_o)	≤ 100mA (continuous) pr. output 100 mA @ 100 nF Load (Short-time) pr. output	
OFF-state current (I_o)	≤ 50 µA	
Minimum operational current (I_m)	> 0,5 mA	
Voltage drop (U_d)	≤ 1.0 VDC @ 100 mA	
Protection	Short circuit, reverse polarity, transients	
Utilization category	DC-12	Control of resistive loads and solid-state loads with optical isolation
	DC-13	Control of electromagnets
Capacitive load	100 nF @ 100 mA, 24 VDC	

Operation diagram

For default factory sensor

T_v = Power-ON delay



Power supply	ON	
Target (Object)	Present	
Break output (N.C.)	ON	
Make output (N.O.)	ON	

Response times

Operating frequency (f)	≤ 1000 Hz	
Response times	≤ 500 μs	OFF-ON (t _{ON})
	≤ 500 μs	ON-OFF (t _{OFF})

Indication

Green LED	Yellow LED	Power	Function
SIO and IO-Link mode			
ON	ON	ON	ON (stable)* SSC1
ON	OFF	ON	OFF (stable)* SSC1
OFF	OFF	OFF	OFF (Not stable) SSC1
Flashing 1 Hz (10% or 90% duty cycle)	-	ON	Connected via IO-Link
-	Flashing 10 Hz 50% duty cycle	ON	Output short-circuit
-	Flashing 0.5...20 Hz 50% duty cycle	ON	Timer triggered indication
SIO mode only			
-	Flashing 1 HZ ON 100 ms OFF 900 ms	ON	External teach by wire. Only for single point mode.
-	Flashing 1 HZ ON 900 ms OFF 100 ms	ON	Teach time window (3 - 6 sec).
-	Flashing 10 HZ ON 50 ms OFF 50 ms Flashing for 2 sec	ON	Teach time out (12 sec).
-	Flashing 2 HZ ON 250 ms OFF 250 ms Flashing for 2 sec	ON	Teach successful.
O-Link mode only			
Flashing 1 HZ ON 900 ms OFF 100 ms	-	ON	Sensor is in IO-Link mode.
Flashing 2 Hz 50% duty cycle		ON	Find my sensor

*See operation diagram



LED indication

LED indication selection	<ul style="list-style-type: none"> • LED indication inactive • LED indication active • Find my sensor <p>Factory settings: LED indication active</p>
---------------------------------	--

Environmental

Ambient temperature	-25° ... +60°C (-13° ... +140°F)	Operating ¹⁾
	-40° ... +85°C (-40° ... +185°F)	Storage ¹⁾
Ambient humidity range	35% ... 95%	Operating ²⁾
	35% ... 95%	Storage ²⁾
Ambient light	≤ 65 000 lux	@ 3000 ... 3200 °K
Vibration	10 ... 150 Hz, 1.0 mm/15 g	EN 60068-2-6
Shock	30 g _n / 11 ms, 3 pos, 3 neg per axis	EN60068-2-27
Drop test	2 x 1 m and 100 x 0.5 m	EN 60068-2-31
Rated insulation voltage (U_i)	50 VDC	
Dielectric insulation voltage	≥ 500 VAC rms	50/60 Hz for 1 min.
Rated impulse withstand voltage	>1 kV (with 500 Ω)	1.2/50 μs
Pollution degree	3	IEC60664, 60664A; EN60947-1
Overvoltage category	III	IEC60664; EN60947-1
Degree of protection	IP67	IEC60539; EN60947-1
NEMA Enclosure Types	1	NEMA 250

¹⁾ Do not bend the cable in temperatures below -10°C

²⁾ With no icing or condensation

EMC

Electrostatic discharge immunity test	± 8 kV @ air discharge or ± 4 kV @ contact discharge	IEC 61000-4-2; EN60947-1
Electromagnetic field immunity	10 V/m	IEC 61000-4-3; EN60947-1
Fast transient immunity	±2 kV / 5 kHz	IEC 61000-4-4; EN60947-1
Wire-conducted noise	10 Vrms	IEC 61000-4-3; EN60947-1
Power frequency magnetic field immunity test	Continuous: >30 A/m, 28 μ tesla Short-time: >300 A/m, 280 μ tesla	IEC 61000-4-8; EN60947-1



Diagnostic parameters

Function	Unit	Range
Sensor Diagnostics		
Frontend Failure	0	0 or 1
Memory Failure	0	0 or 1
Temperature Diagnostics		
Current temperature	[°C]	-50 ... +150
Maximum temperature - All time high	[°C]	-50 ... +150
Minimum temperature - All time low	[°C]	-50 ... +150
Maximum temperature - Since last power-up	[°C]	-50 ... +150
Minimum temperature - Since last power-up	[°C]	-50 ... +150
Minutes above Maximum Temperature	[min]	0 ... 2 147 483 647
Minutes below Minimum Temperature	[min]	0 ... 2 147 483 647
Operating Diagnostic		
Operating Hours	[h]	0 ... 2 147 483 647
Number of Power Cycles	[cycles]	0 ... 2 147 483 647
Detection counter SSC1	[cycles]	0 ... 2 147 483 647
Maintenance event counter	[cycles]	0 ... 2 147 483 647
Download counter	[counts]	0 ...65 536
Quality of Teach	-	0 ... 255%
Quality of Run	-	0 ... 255%
Excess gain		0 ... 255
Error Count	[counts]	0 ...65 536
Device Status	0 = Device is operating properly 1 = Maintenance required 2 = Out-of-specification 3 = Functional-Check 4 = Failure Factory settings: 0	

Events Configuration

Events	Factory default setting
Maintenance Event	Inactive
Temperature fault event	Inactive
Temperature over-run	Inactive
Temperature under-run	Inactive
Short circuit	Inactive

Observation menu

Process Data	Factory default setting
Analogue value	Analogue value Inactive
	Analogue value normal Factory settings
	Analogue value as Object Length
	Analogue value as Object Speed
	Analogue value as Counter value
Excess gain	Inactive
SO1, Switching output 1	Active
SO2, Switching output 2	Active
SSC1, Sensor switching channel 1	Inactive
SSC2, Sensor switching channel 2	Inactive
DA1, Dust alarm SSC1	Inactive
DA2, Dust alarm SSC2	Inactive
TA, Temperature alarm	Inactive
SC, Short circuit	Inactive
WDA1, Water drop alarm SSC1	Inactive
WDA2, Water drop alarm SSC2	Inactive
AFO1, Application functions output 1	Inactive

Process data structure

4 Bytes, Analogue value 16 ... 31 (16 bit)

Byte 0	31	30	29	28	27	26	25	24
	MSB	-	-	-	-	-	-	-
Byte 1	23	22	21	20	19	18	17	16
	-	-	-	-	-	-	-	LSB
Byte 2	15	14	13	12	11	10	9	8
	-	-	SC	TA	DA2	DA1	SSC2	SSC1
Byte 3	7	6	5	4	3	2	1	0
	AFO1	-	-	-	WDA2	WDA1	SO2	SO1



Mechanics/electronics

▶ Connection

Cable	2 m, 4-wire 4 x 0.14 mm ² , Ø = 3.3 mm, PVC, Black
Plug	M8, 4-pin, male

▶ Wiring

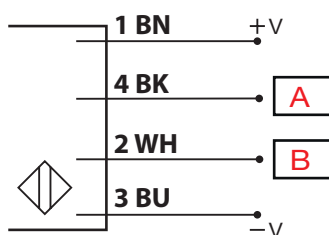

BN	BK	WH	BU	A	B
Brown	Black	White	Blue	OUT/IO-Link	IN/OUT

▶ Housing

Body	ABS	
Front glass	PMMA, Red	
Trimmer shaft	POM, Grey	
Indication	TPU, Transparent	
Sealing	NBR70	
Dimensions	10 x 30 x 20 mm	
Weight	≤ 50 g	Cable version
	≤ 20 g	Plug version



Dimensions

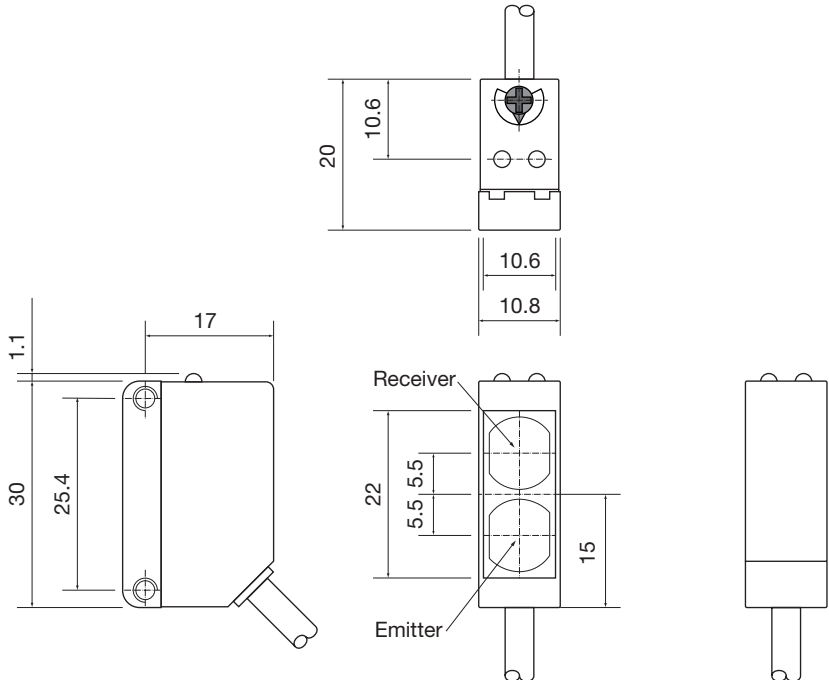

Fig. 4 Cable

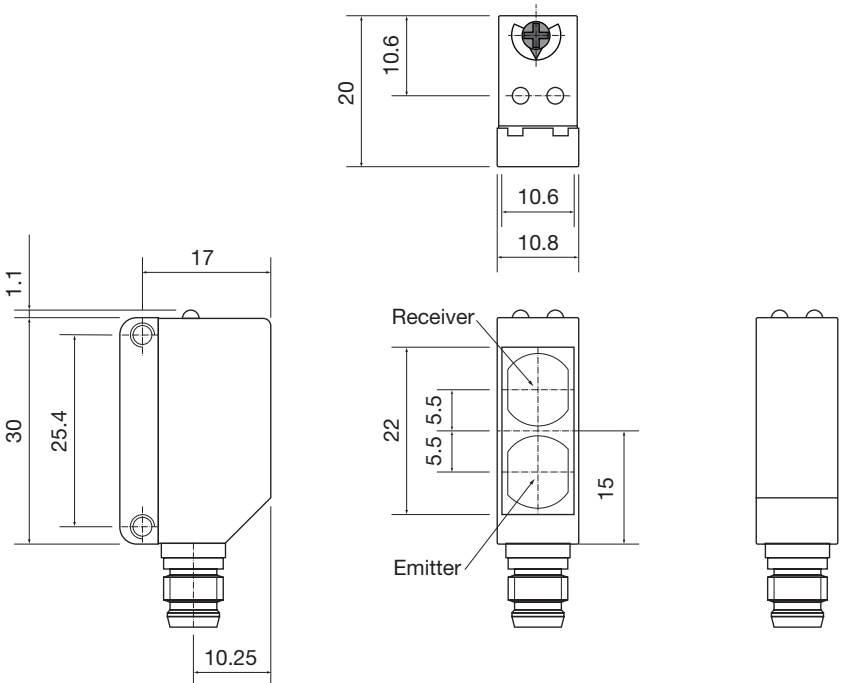



Fig. 5 Plug

Compatibility and conformity

Approvals and markings

General reference	Sensor designed according to EN60947-5-2	
MTTF_d	138.5 years	EN ISO 13849-1, SN 29500
CE-marking		
Approvals		

IO-Link

IO-Link revision	1.1
Transmission rate	COM2 (38.4 kbaud)
SDCI-Norm	IEC 61131-9
Profile	Smart sensor profile 2nd edition, common profile
Min. cycle time	5 ms
SIO mode	Yes
Min. master port class	A (4-pin)
Process data length	32 bit



Delivery contents and accessories



▶ Delivery contents

- Photoelectric switch: PD30CTRR60BPxxIO
- Screwdriver
- Packaging: Plastic bag

▶ Accessories

- Mounting bracket: APD30-MB1 or APD30-MB2 to be purchased separately
- Connector type: CO..54NF... series to be purchased separately

▶ Further information

Information	Where to find it	QR
IO-Link manual	http://cga.pub/?063a58	
Mounting brackets	http://cga.pub/?6fa29a	
Connectors	http://cga.pub/?0aae3e	



COPYRIGHT ©2021
 Content subject to change. Download the PDF: www.gavazziautomation.com