

## P-Channel Enhancement Mode Power MOSFET

### Description

The RM2333A uses advanced trench technology to provide excellent  $R_{DS(ON)}$ , low gate charge and operation with gate voltages as low as 2.5V. This device is suitable for use as a load switch or in PWM applications.

### General Features

- $V_{DS} = -12V, I_D = -6A$   
 $R_{DS(ON)} < 45m\Omega(max) @ V_{GS} = -2.5V$   
 $R_{DS(ON)} < 30m\Omega(max) @ V_{GS} = -4.5V$
- High power and current handling capability
- Lead free product is acquired
- Surface mount package

### Application

- PWM applications
- Load switch
- Power management
- Halogen-free
- P/N suffix V means AEC-Q101 qualified, e.g:RM2333AV

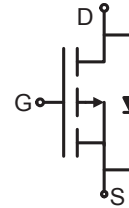

Schematic diagram

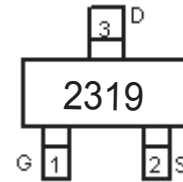

Marking and pin assignment



SOT-23-3L top view

Device Marking	Device	Device Package	Reel Size	Tape width	Quantity
2319	RM2333A	SOT-23-3L	Ø180mm	8 mm	3000 units

### Absolute Maximum Ratings (TA=25°C unless otherwise noted)

Parameter	Symbol	Limit	Unit
Drain-Source Voltage	$V_{DS}$	-12	V
Gate-Source Voltage	$V_{GS}$	±12	V
Drain Current -Continuous	$I_D$	-6	A
Drain Current -Pulsed <sup>(Note 1)</sup>	$I_{DM}$	-20	A
Maximum Power Dissipation	$P_D$	1.8	W
Operating Junction and Storage Temperature Range	$T_J, T_{STG}$	-55 To 150	°C

### Thermal Characteristic

Thermal Resistance, Junction-to-Ambient <sup>(Note 2)</sup>	$R_{\theta JA}$	69	°C/W
---	-----------------	----	------

### Electrical Characteristics (TA=25°C unless otherwise noted)

Parameter	Symbol	Condition	Min	Typ	Max	Unit
<b>Off Characteristics</b>						
Drain-Source Breakdown Voltage	$BV_{DSS}$	$V_{GS}=0V, I_D=-250\mu A$	-12	-	-	V

Zero Gate Voltage Drain Current	$I_{DSS}$	$V_{DS}=-12V, V_{GS}=0V$	-	-	-1	$\mu A$
Gate-Body Leakage Current	$I_{GSS}$	$V_{GS}=\pm 12V, V_{DS}=0V$	-	-	$\pm 100$	nA
<b>On Characteristics</b> (Note 3)						
Gate Threshold Voltage	$V_{GS(th)}$	$V_{DS}=V_{GS}, I_D=-250\mu A$	-0.4	-0.65	-1.0	V
Drain-Source On-State Resistance	$R_{DS(ON)}$	$V_{GS}=-4.5V, I_D=-6A$	-	19	30	m $\Omega$
		$V_{GS}=-2.5V, I_D=-5A$	-	26	45	
Forward Transconductance	$g_{FS}$	$V_{DS}=-5V, I_D=-6A$		17	-	S
<b>Dynamic Characteristics</b> (Note4)						
Input Capacitance	$C_{iss}$	$V_{DS}=-6V, V_{GS}=0V,$ $F=1.0MHz$	-	1100	-	PF
Output Capacitance	$C_{oss}$		-	390	-	PF
Reverse Transfer Capacitance	$C_{rss}$		-	300	-	PF
<b>Switching Characteristics</b> (Note 4)						
Turn-on Delay Time	$t_{d(on)}$	$V_{DD}=-6V, I_D=-1A,$ $R_L=6\Omega, V_{GEN}=-4.5V, R_g=6\Omega$	-	25	-	nS
Turn-on Rise Time	$t_r$		-	45	-	nS
Turn-Off Delay Time	$t_{d(off)}$		-	72	-	nS
Turn-Off Fall Time	$t_f$		-	60	-	nS
Total Gate Charge	$Q_g$	$V_{DS}=-6V, I_D=-6A, V_{GS}=-4.5V$	-	11.5	-	nC
Gate-Source Charge	$Q_{gs}$		-	1.5	-	nC
Gate-Drain Charge	$Q_{gd}$		-	3.2	-	nC
<b>Drain-Source Diode Characteristics</b>						
Diode Forward Voltage (Note 3)	$V_{SD}$	$V_{GS}=0V, I_S=-1.0A$	-	-	-1.2	V
Diode Forward Current (Note 2)	$I_S$		-	-	-6	A

### Notes:

1. Repetitive Rating: Pulse width limited by maximum junction temperature.
2. Surface Mounted on FR4 Board,  $t \leq 10$  sec.
3. Pulse Test: Pulse Width  $\leq 300\mu s$ , Duty Cycle  $\leq 2\%$ .
4. Guaranteed by design, not subject to production

# RATING AND CHARACTERISTICS CURVES (RM2333A)

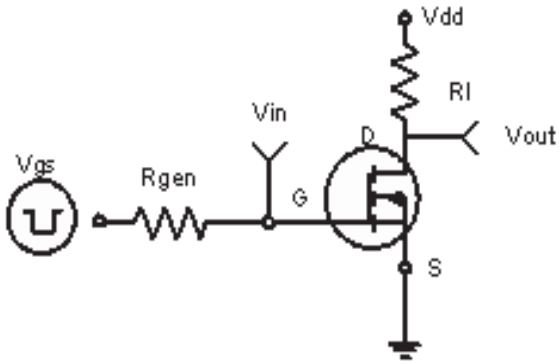

Figure 1: Switching Test Circuit

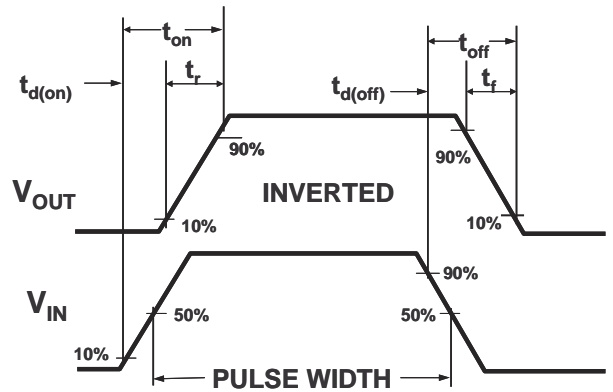
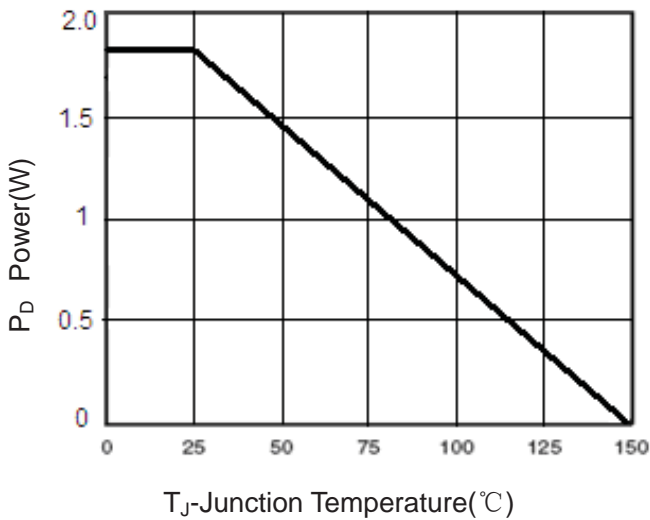
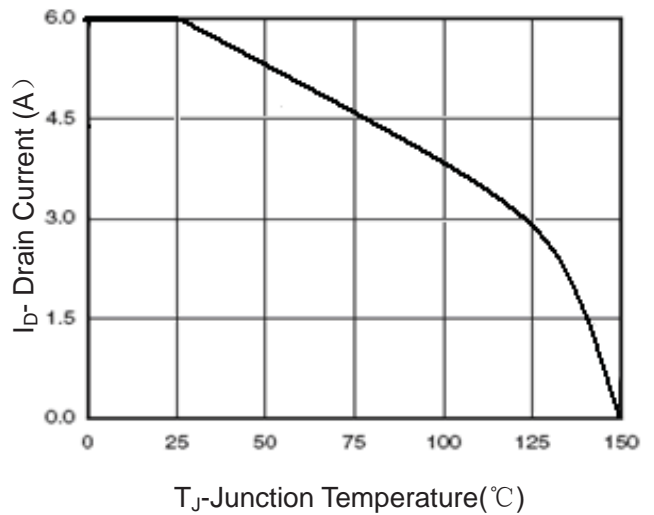

Figure 2: Switching Waveforms



T<sub>J</sub>-Junction Temperature(°C)  
Figure 3 Power Dissipation



T<sub>J</sub>-Junction Temperature(°C)  
Figure 4 Drain Current

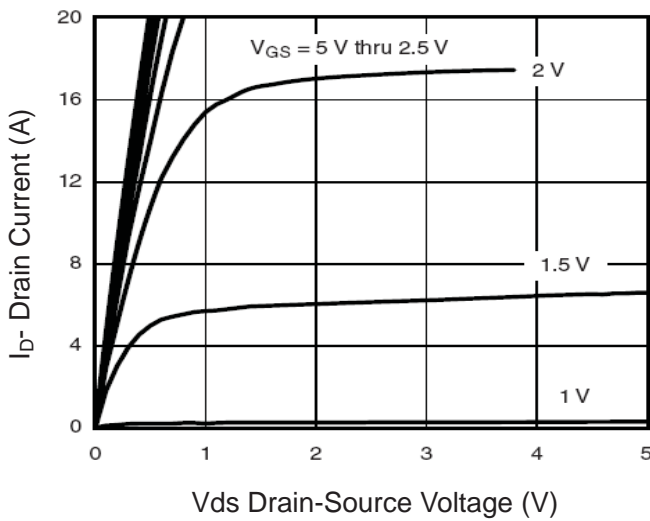

V<sub>ds</sub> Drain-Source Voltage (V)  
Figure 5 Output Characteristics

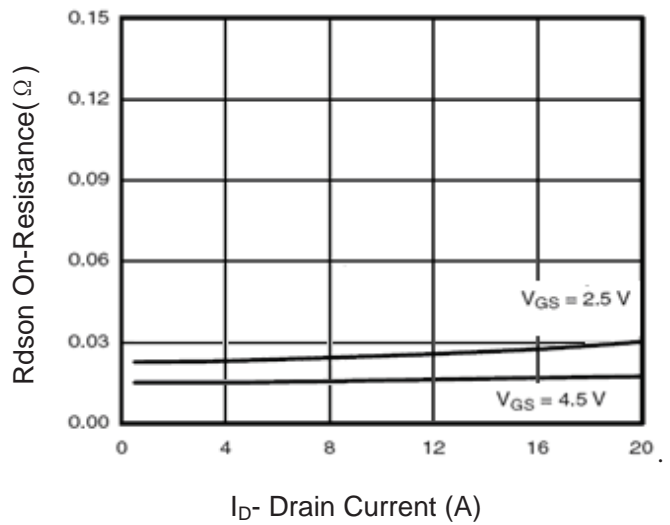

I<sub>D</sub> Drain Current (A)  
Figure 6 Drain-Source On-Resistance

## RATING AND CHARACTERISTICS CURVES (RM2333A)

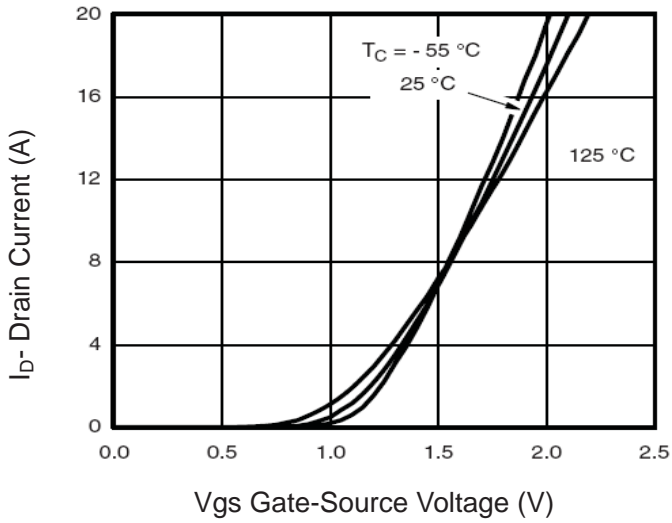

Vgs Gate-Source Voltage (V)  
**Figure 7 Transfer Characteristics**

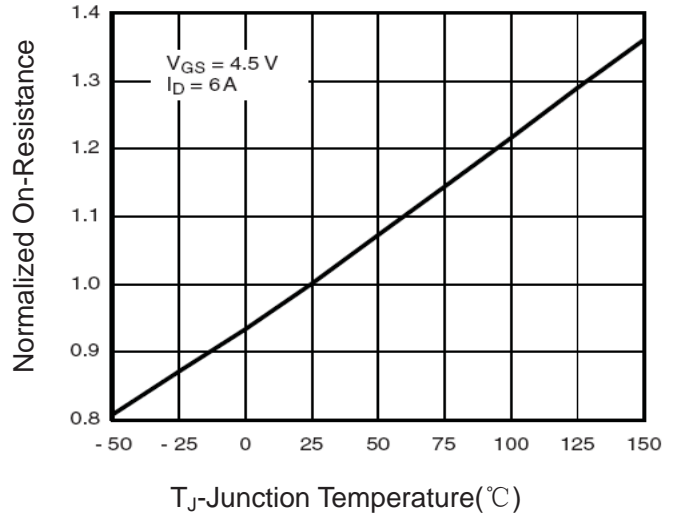

$T_J$ -Junction Temperature( $^\circ\text{C}$ )  
**Figure 8 Drain-Source On-Resistance**

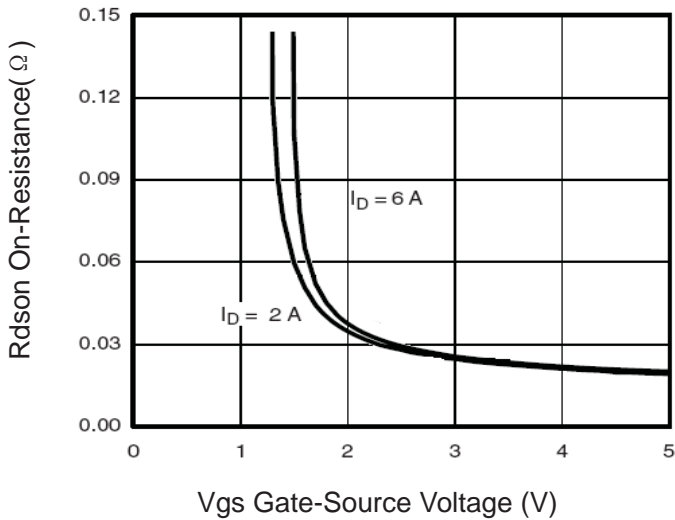

Vgs Gate-Source Voltage (V)  
**Figure 9 Rdson vs Vgs**

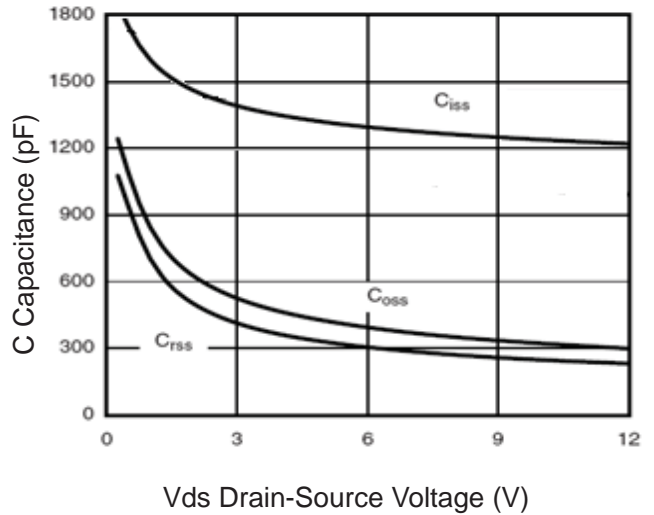

Vds Drain-Source Voltage (V)  
**Figure 10 Capacitance vs Vds**

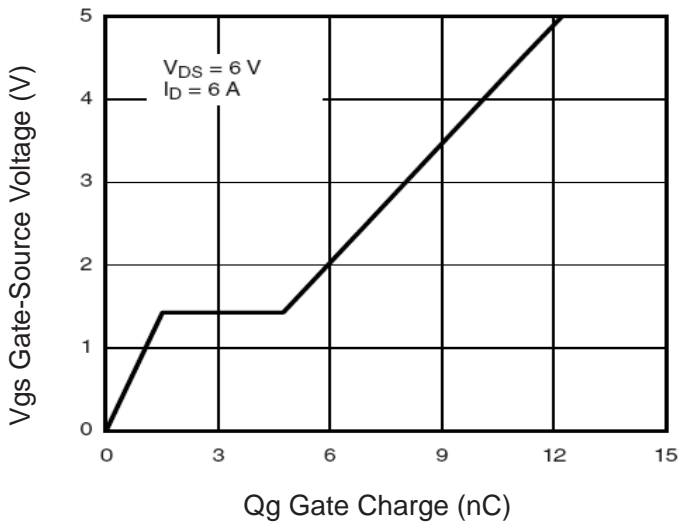

Qg Gate Charge (nC)  
**Figure 11 Gate Charge**

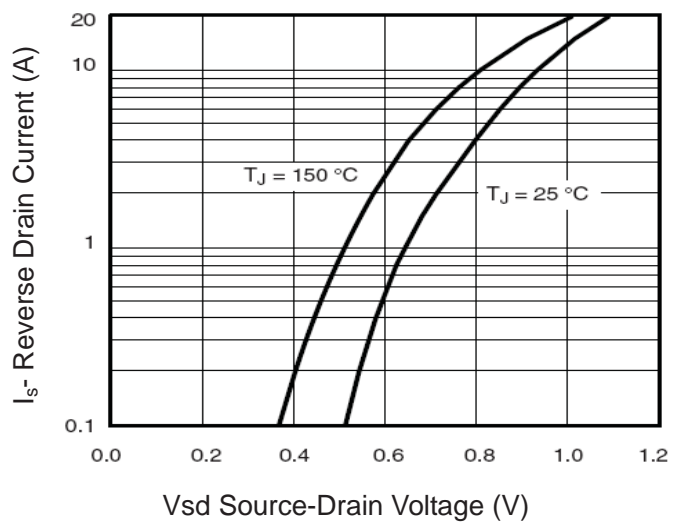

Vsd Source-Drain Voltage (V)  
**Figure 12 Source- Drain Diode Forward**

## RATING AND CHARACTERISTICS CURVES (RM2333A)

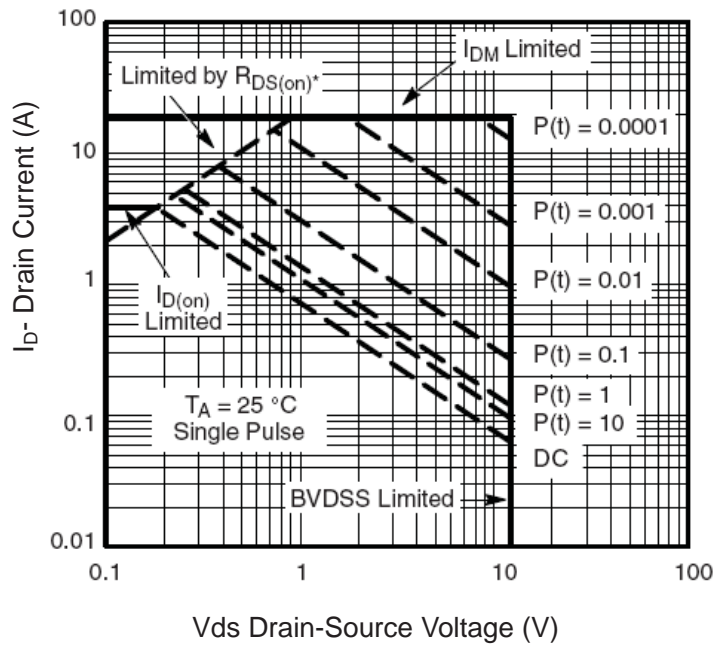

Figure 13 Safe Operation Area

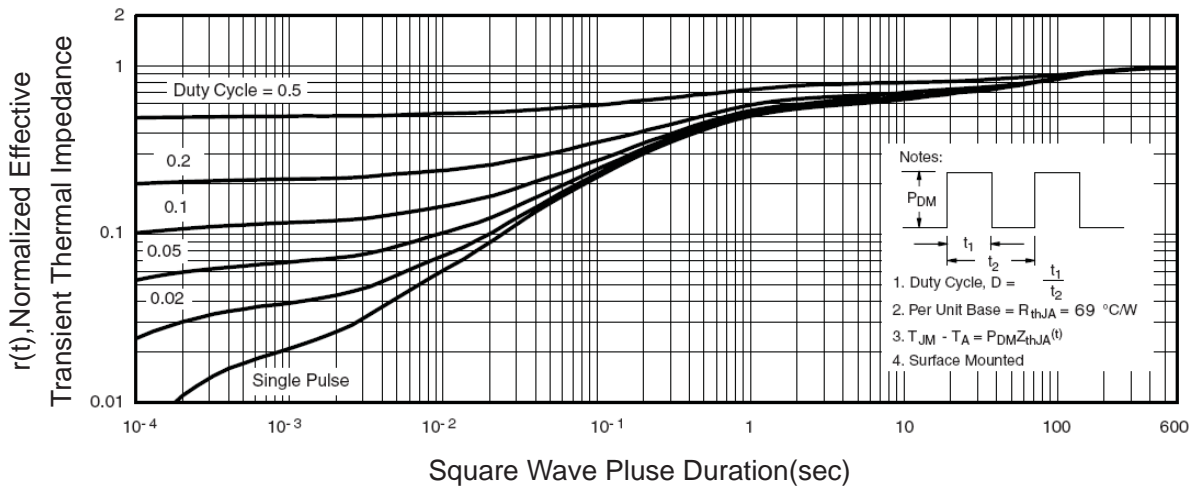
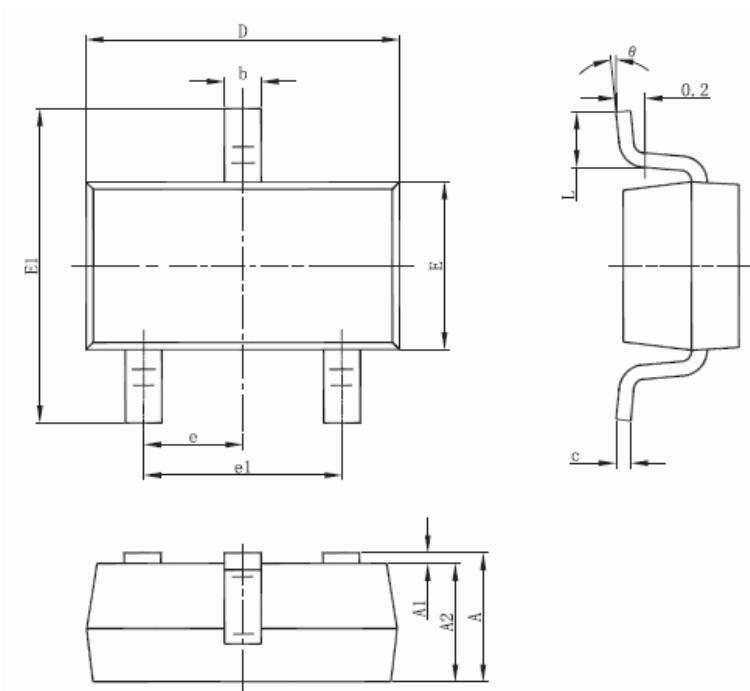

Figure 14 Normalized Maximum Transient Thermal Impedance

## SOT-23-3L Package Information



Symbol	Dimensions In Millimeters		Dimensions In Inches	
	Min	Max	Min	Max
A	1.050	1.250	0.041	0.049
A1	0.000	0.100	0.000	0.004
A2	1.050	1.150	0.041	0.045
b	0.300	0.500	0.012	0.020
c	0.100	0.200	0.004	0.008
D	2.820	3.020	0.111	0.119
E	1.500	1.700	0.059	0.067
E1	2.650	2.950	0.104	0.116
e	0.950(BSC)		0.037(BSC)	
e1	1.800	2.000	0.071	0.079
L	0.300	0.600	0.012	0.024
$\theta$	0°	8°	0°	8°

### Notes

1. All dimensions are in millimeters.
2. Tolerance  $\pm 0.10\text{mm}$  (4 mil) unless otherwise specified
3. Package body sizes exclude mold flash and gate burrs. Mold flash at the non-lead sides should be less than 5 mils.
4. Dimension L is measured in gauge plane.
5. Controlling dimension is millimeter, converted inch dimensions are not necessarily exact.

## DISCLAIMER NOTICE

Rectron Inc reserves the right to make changes without notice to any product specification herein, to make corrections, modifications, enhancements or other changes. Rectron Inc or anyone on its behalf assumes no responsibility or liability for any errors or inaccuracies. Data sheet specifications and its information contained are intended to provide a product description only. "Typical" parameters which may be included on RECTRON data sheets and/ or specifications can and do vary in different applications and actual performance may vary over time. Rectron Inc does not assume any liability arising out of the application or use of any product or circuit.

Rectron products are not designed, intended or authorized for use in medical, life-saving implant or other applications intended for life-sustaining or other related applications where a failure or malfunction of component or circuitry may directly or indirectly cause injury or threaten a life without expressed written approval of Rectron Inc. Customers using or selling Rectron components for use in such applications do so at their own risk and shall agree to fully indemnify Rectron Inc and its subsidiaries harmless against all claims, damages and expenditures.