

SBT-0210T

Aliases (UDLSBT00210T00)

KEMET, SBT, DC Line Filters, Normal Mode, 10 uH, 50%

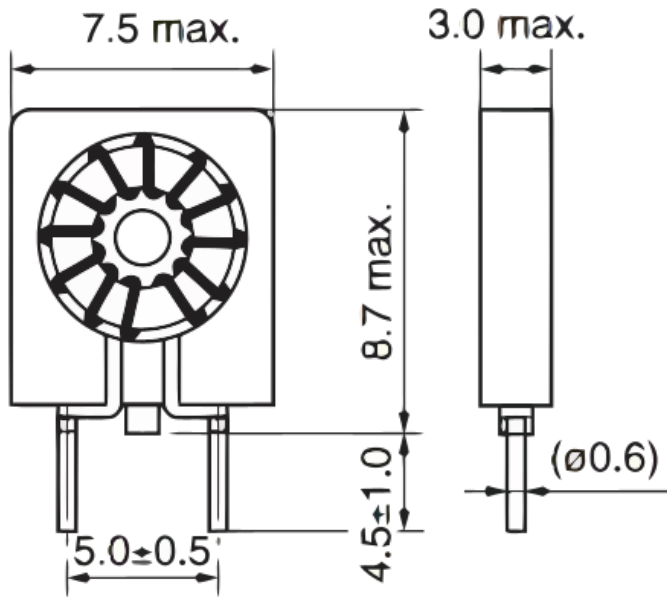

Click [here](#) for the 3D model.

Dimensions

L	7.5mm MAX
W	3mm MAX
T	3mm MAX
H	8.7mm MAX
LL	4.5mm +/-1mm
S	5mm +/-0.5mm

Packaging Specifications

Packaging	T&R
Packaging Quantity	2000
Component Weight	240 mg

General Information

Series	SBT
Style	Through-Hole
RoHS	Yes
Miscellaneous	Inductance: 70mAmps (1kHz).

Specifications

Voltage DC	50 VDC
Inductance	10 uH
Inductance Tolerance	50%
Temperature Range	-25/+70°C
DC Resistance	20 mOhms