

# Printed-circuit board connector - MC 0,5/ 4-G-2,54 P20THRR24C2 - 1706204

Please be informed that the data shown in this PDF Document is generated from our Online Catalog. Please find the complete data in the user's documentation. Our General Terms of Use for Downloads are valid (<http://phoenixcontact.com/download>)

PCB headers, nominal current: 6 A, number of positions: 4, pitch: 2.54 mm, color: black, contact surface: Gold, mounting: THR soldering, Fixed coding of the last position, can be combined with the FMC 0,5/...-ST-2,54 C2 connector



The figure shows the 10-position version

## Your advantages

- ✓ Designed for integration into the SMT soldering process
- ✓ Additional solder anchors reduce the mechanical strain on the soldering spots
- ✓ Gold-plated contacts ensure transfer quality remains stable over the long term
- ✓ Supplied in tape-on-reel packing according to IEC 60286-3 for automated mounting

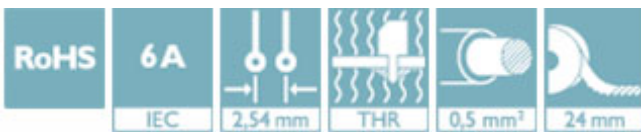

## Key Commercial Data

Packing unit	465 pc
Minimum order quantity	465 pc
GTIN	 4 046356 841573
GTIN	4046356841573

## Technical data

### Dimensions

Length [ l ]	7.1 mm
Width	14.7 mm
Pitch	2.54 mm
Dimension a	7.62 mm
Width [ w ]	14.7 mm
Height [ h ]	6.85 mm
Height	4.85 mm
Length of the solder pin	2 mm
Pin dimensions	0.64 x 0.64 mm

# Printed-circuit board connector - MC 0,5/ 4-G-2,54 P20THRR24C2 - 1706204

## Technical data

### Dimensions

Length	7.1 mm
--------	--------

### General

Range of articles	MC 0,5/...G-THR
Insulating material group	IIIa
Rated surge voltage (III/3)	2.5 kV
Rated surge voltage (III/2)	2.5 kV
Rated surge voltage (II/2)	2.5 kV
Rated voltage (III/3)	32 V
Rated voltage (III/2)	160 V
Rated voltage (II/2)	160 V
Connection in acc. with standard	EN-VDE
Nominal current I <sub>N</sub>	6 A
Insulating material	LCP
Flammability rating according to UL 94	V0
Color	black
Number of positions	4

### Standards and Regulations

Connection in acc. with standard	EN-VDE
Flammability rating according to UL 94	V0

### Environmental Product Compliance

China RoHS	Environmentally friendly use period: unlimited = EFUP-e
	No hazardous substances above threshold values

## Drawings

# Printed-circuit board connector - MC 0,5/ 4-G-2,54 P20THRR24C2 - 1706204

Drilling diagram

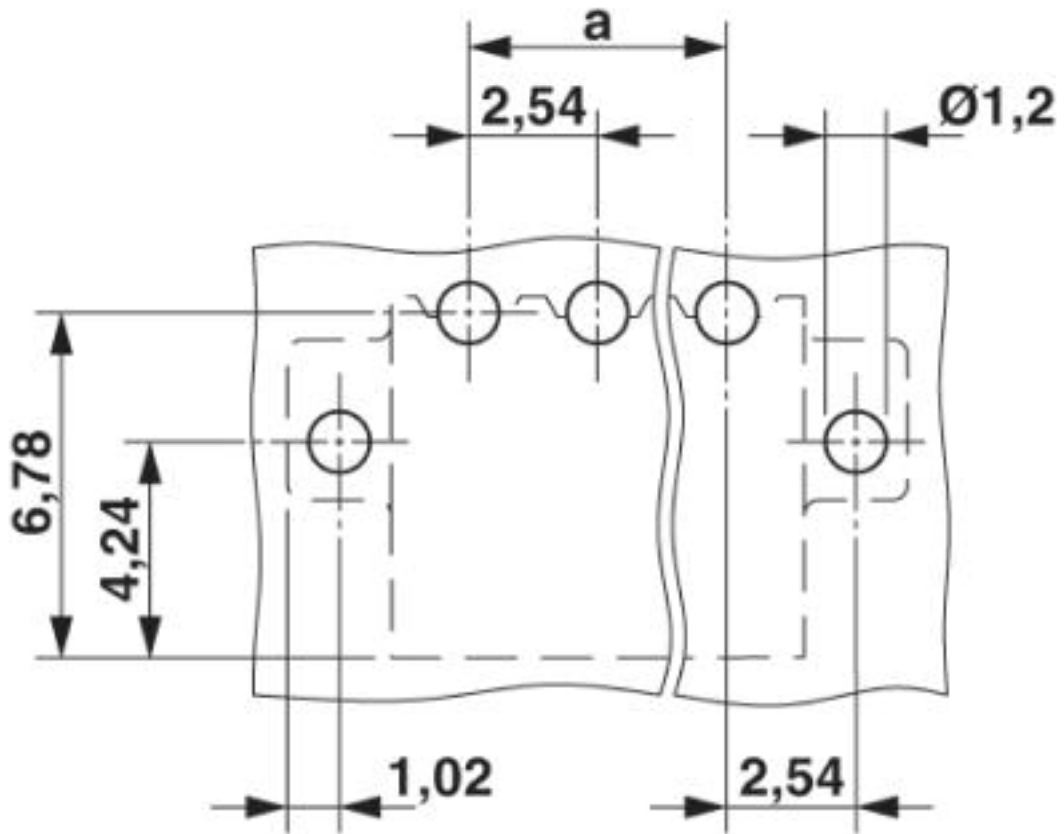

# Printed-circuit board connector - MC 0,5/ 4-G-2,54 P20THRR24C2 - 1706204

Diagram

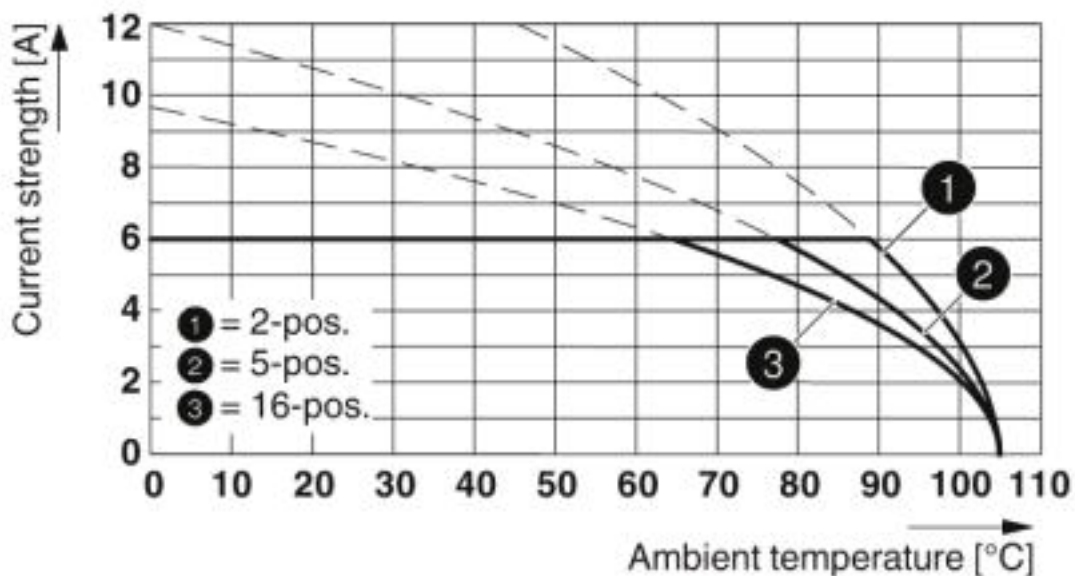

Type: MCC 0,5/...-ST-2,54 with MC 0,5/...-G-2,54 P20 THR R...

Dimensional drawing

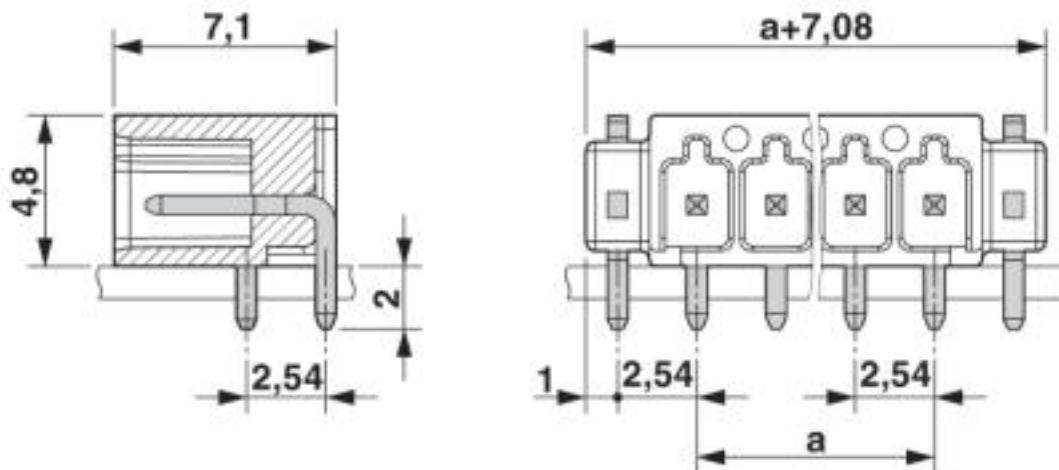

Approvals

Approvals

Approvals

IECEE CB Scheme / VDE Gutachten mit Fertigungsüberwachung / EAC / cULus Recognized

# Printed-circuit board connector - MC 0,5/ 4-G-2,54 P20THRR24C2 - 1706204

## Approvals

Ex Approvals

### Approval details

IECEE CB Scheme		<a href="http://www.iecee.org/">http://www.iecee.org/</a>	DE1-55663-B1
Nominal voltage UN	160 V		
Nominal current IN	6 A		

VDE Gutachten mit Fertigungsüberwachung		<a href="http://www2.vde.com/de/Institut/Online-Service/VDE-gepruefteProdukte/Seiten/Online-Suche.aspx">http://www2.vde.com/de/Institut/Online-Service/VDE-gepruefteProdukte/Seiten/Online-Suche.aspx</a>	40042258
Nominal voltage UN	160 V		
Nominal current IN	6 A		

EAC		B.01742
-----	---	---------

cULus Recognized		<a href="http://database.ul.com/cgi-bin/XYV/template/LISEXT/1FRAME/index.htm">http://database.ul.com/cgi-bin/XYV/template/LISEXT/1FRAME/index.htm</a>	E60425-19920306
	B	C	
Nominal voltage UN	150 V	50 V	
Nominal current IN	6 A	6 A	

Phoenix Contact 2019 © - all rights reserved  
<http://www.phoenixcontact.com>

PHOENIX CONTACT GmbH & Co. KG  
Flachsmarktstr. 8  
32825 Blomberg  
Germany  
Tel. +49 5235 300  
Fax +49 5235 3 41200  
<http://www.phoenixcontact.com>