

TOLERANCE UNLESS OTHERWISE SPECIFIED	
.X	±0.25
.XX	±0.13
.XXX	±0.05

THIS IS A C.A.D. GENERATED DRAWING  
DO NOT MAKE MANUAL REVISIONS TO MASTER.

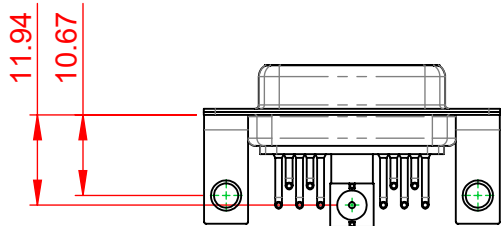

ISSUE NUMBER	
ORIGINAL	①

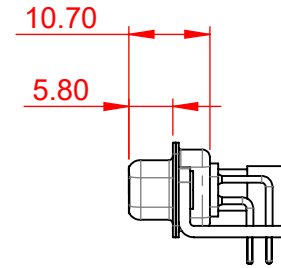
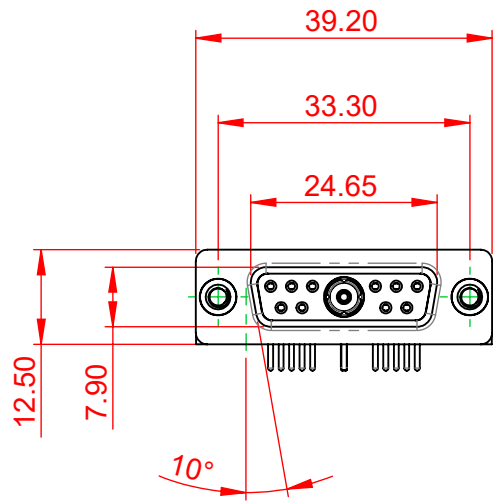

**NOTES:**

**MATERIAL:**  
**HOUSING:** THERMOPLASTIC POLYESTER, UL94V-0  
**SHELL:** STEEL, NICKEL PLATED  
**CONTACT:** COPPER ALLOY, 30µ GOLD PLATED

**OPERATING TEMPERATURE:** -55°C ~ 125°C

**POWER/CO-AX CONTACT RATING:** 75Ω (IMPEDANCE)  
(IF PRESENT)

**SIGNAL CONTACT CURRENT RATING:** 5A PER CONTACT

**SIGNAL CONTACT RESISTANCE:** 10mΩ MAX.

**INSULATOR RESISTANCE:** 5000MΩ min.

**DIELECTRIC**

**WITHSTANDING VOLTAGE:** 1000V AC rms

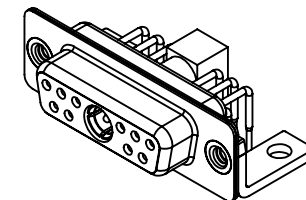

THIS SERIES FULLY CONFORMS TO  
THE EUROPEAN UNION DIRECTIVES  
2011/65/EU FOR RoHS COMPLIANCY.



YOUR CONNECTION TO QUALITY & SERVICE

EDAC INC  
TORONTO, ONTARIO  
CANADA

THESE DRAWINGS AND SPECIFICATIONS  
ARE THE PROPERTY OF EDAC INC., AND  
SHALL NOT BE REPRODUCED, OR COPIED  
OR USED AS THE BASIS FOR THE  
MANUFACTURE OR SALE OF APPARATUS  
WITHOUT WRITTEN PERMISSION.

**COMBINATION D-SUB**

SW REFERENCE NO.: 630 COMBO ASSEMBLY	
DRAWN: C.B	DATE: JAN. 01/2019
CHECKED:	DATE:
SCALE: (IN C.A.D. 1:1)	SHEET 1 OF 2
DRAWING NUMBER: 630-11W1640-7N4	ISSUE
PART NUMBER: 630-11W1640-7N4	1

TOLERANCE UNLESS OTHERWISE SPECIFIED	
.X	±0.25
.XX	±0.13
.XXX	±0.05

THIS IS A C.A.D. GENERATED DRAWING  
DO NOT MAKE MANUAL REVISIONS TO MASTER.



ISSUE NUMBER	
ORIGINAL	①



<b>COMBINATION D-SUB</b>		SW REFERENCE NO.: 630 COMBO ASSEMBLY	
		DRAWN: C.B	DATE: JAN. 01/2019
		CHECKED:	DATE:
		SCALE: N.T.S	SHEET 2 OF 2
		DRAWING NUMBER: 630-11W1640-7N4	ISSUE
		PART NUMBER: 630-11W1640-7N4	1



THIS SERIES FULLY CONFORMS TO  
THE EUROPEAN UNION DIRECTIVES  
2011/65/EU FOR RoHS COMPLIANCY.



**EDAC** INC  
TORONTO, ONTARIO  
CANADA  
YOUR CONNECTION TO QUALITY & SERVICE

THESE DRAWINGS AND SPECIFICATIONS  
ARE THE PROPERTY OF EDAC INC., AND  
SHALL NOT BE REPRODUCED, OR COPIED  
OR USED AS THE BASIS FOR THE  
MANUFACTURE OR SALE OF APPARATUS  
WITHOUT WRITTEN PERMISSION.