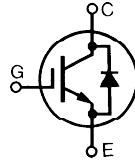


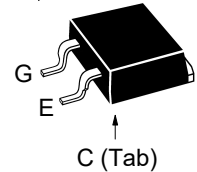
# High Voltage, High Gain BIMOSFET™ Monolithic Bipolar MOS Transistor

## IXBA10N300HV IXBH10N300HV

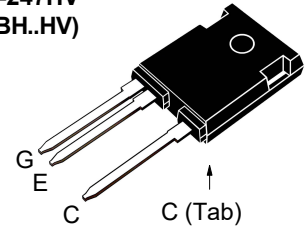
$V_{CES} = 3000V$   
 $I_{C110} = 10A$   
 $V_{CE(sat)} \leq 2.8V$



TO-263HV  
(IXBA..HV)



TO-247HV  
(IXBH..HV)



G = Gate      C = Collector  
 E = Emitter    Tab = Collector

Symbol	Test Conditions	Maximum Ratings	
$V_{CES}$	$T_C = 25^\circ C$ to $150^\circ C$	3000	V
$V_{CGR}$	$T_J = 25^\circ C$ to $150^\circ C$ , $R_{GE} = 1M\Omega$	3000	V
$V_{GES}$	Continuous	$\pm 20$	V
$V_{GEM}$	Transient	$\pm 30$	V
$I_{C25}$	$T_C = 25^\circ C$	34	A
$I_{C110}$	$T_C = 110^\circ C$	10	A
$I_{CM}$	$T_C = 25^\circ C$ , 1ms	88	A
<b>SSOA</b> <b>(RBSOA)</b>	$V_{GE} = 15V$ , $T_{VJ} = 125^\circ C$ , $R_G = 10\Omega$ Clamped Inductive Load	$I_{CM} = 80$ 1500	A V
$T_{SC}$ <b>(SCSOA)</b>	$V_{GE} = 15V$ , $T_J = 125^\circ C$ , $R_G = 82\Omega$ , $V_{CE} = 1500V$ , Non-Repetitive	10	$\mu s$
$P_c$	$T_C = 25^\circ C$	180	W
$T_J$		-55 ... +150	$^\circ C$
$T_{JM}$		150	$^\circ C$
$T_{stg}$		-55 ... +150	$^\circ C$
$T_L$	Maximum Lead Temperature for Soldering	300	$^\circ C$
$T_{SOLD}$	1.6 mm (0.062 in.) from Case for 10s	260	$^\circ C$
$F_c$	Mounting Force (TO-263HV)	10..65 / 2.2..14.6	N/lb
$M_d$	Mounting Torque (TO-247HV)	1.13/10	Nm/lb.in
<b>Weight</b>	TO-263HV	2.5	g
	TO-247HV	6.0	g

### Features

- High Blocking Voltage
- Anti-Parallel Diode
- Low Conduction Losses

### Advantages

- Low Gate Drive Requirement
- High Power Density

### Applications

- Switch-Mode and Resonant-Mode Power Supplies
- Uninterruptible Power Supplies (UPS)
- Laser Generators
- Capacitor Discharge Circuits
- AC Switches

Symbol	Test Conditions ( $T_J = 25^\circ C$ Unless Otherwise Specified)	Characteristic Values		
		Min.	Typ.	Max.
$BV_{CES}$	$I_C = 250\mu A$ , $V_{GE} = 0V$	3000		V
$V_{GE(th)}$	$I_C = 250\mu A$ , $V_{CE} = V_{GE}$	3.0		5.0 V
$I_{CES}$	$V_{CE} = 0.8 \cdot V_{CES}$ , $V_{GE} = 0V$ $T_J = 125^\circ C$			25 $\mu A$ 500 $\mu A$
$I_{GES}$	$V_{CE} = 0V$ , $V_{GE} = \pm 20V$			$\pm 100$ nA
$V_{CE(sat)}$	$I_C = 10A$ , $V_{GE} = 15V$ , Note 1 $T_J = 125^\circ C$		2.2 2.7	2.8 V V

Symbol Test Conditions ( $T_J = 25^\circ\text{C}$ Unless Otherwise Specified)		Characteristic Values		
		Min.	Typ.	Max.
$g_{fs}$	$I_C = 10\text{A}, V_{CE} = 10\text{V}$ , Note 1	6	11	S
$C_{ies}$	$V_{CE} = 25\text{V}, V_{GE} = 0\text{V}, f = 1\text{MHz}$		1044	pF
$C_{oes}$			42	pF
$C_{res}$			14	pF
$Q_g$	$I_C = 10\text{A}, V_{GE} = 15\text{V}, V_{CE} = 1000\text{V}$		46	nC
$Q_{ge}$			5	nC
$Q_{gc}$			20	nC
$t_{d(on)}$	<b>Resistive Switching Times, <math>T_J = 25^\circ\text{C}</math></b> $I_C = 10\text{A}, V_{GE} = 15\text{V}$ $V_{CE} = 960\text{V}, R_G = 10\Omega$		36	ns
$t_r$			340	ns
$t_{d(off)}$			100	ns
$t_f$			1850	ns
$t_{d(on)}$	<b>Resistive Switching Times, <math>T_J = 125^\circ\text{C}</math></b> $I_C = 10\text{A}, V_{GE} = 15\text{V}$ $V_{CE} = 960\text{V}, R_G = 10\Omega$		40	ns
$t_r$			765	ns
$t_{d(off)}$			120	ns
$t_f$			2010	ns
$R_{thJC}$	TO-247HV		0.69	$^\circ\text{C/W}$
$R_{thCS}$			0.21	$^\circ\text{C/W}$

### Reverse Diode

Symbol Test Conditions ( $T_J = 25^\circ\text{C}$ Unless Otherwise Specified)		Characteristic Values		
		Min.	Typ.	Max.
$V_F$	$I_F = 10\text{A}, V_{GE} = 0\text{V}$		2.7	V
$t_{rr}$	$I_F = 5\text{A}, V_{GE} = 0\text{V}, -di_F/dt = 100\text{A}/\mu\text{s}$ $V_R = 100\text{V}, V_{GE} = 0\text{V}$		1.6	$\mu\text{s}$
$I_{RM}$			23	A
$Q_{RM}$			18.6	$\mu\text{C}$

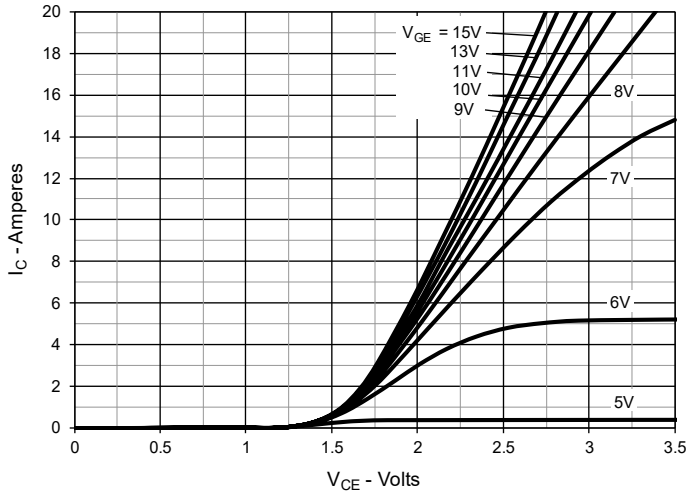
Note 1: Pulse test,  $t \leq 300\mu\text{s}$ , duty cycle,  $d \leq 2\%$ .

Littelfuse reserves the right to change limits, test conditions and dimensions.

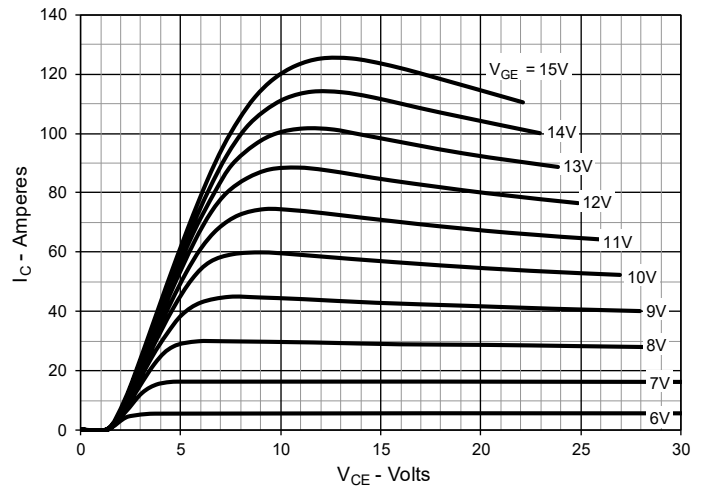
IXYS MOSFETs and IGBTs are covered by one or more of the following U.S. patents:

4,835,592	4,931,844	5,049,961	5,237,481	6,162,665	6,404,065 B1	6,683,344	6,727,585	7,005,734 B2	7,157,338B2
4,860,072	5,017,508	5,063,307	5,381,025	6,259,123 B1	6,534,343	6,710,405 B2	6,759,692	7,063,975 B2	
4,881,106	5,034,796	5,187,117	5,486,715	6,306,728 B1	6,583,505	6,710,463	6,771,478 B2	7,071,537	

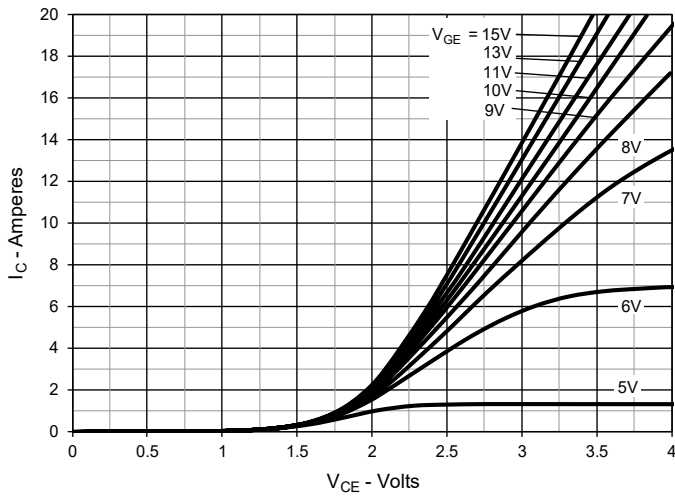
**Fig. 1. Output Characteristics @  $T_J = 25^\circ\text{C}$**



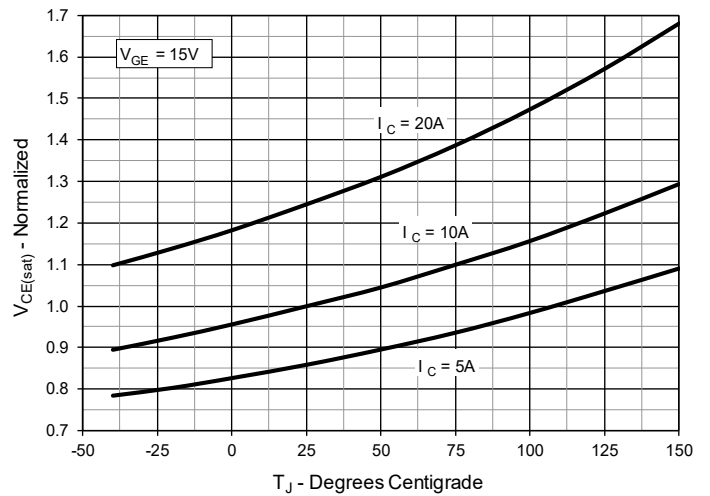
**Fig. 2. Extended Output Characteristics @  $T_J = 25^\circ\text{C}$**



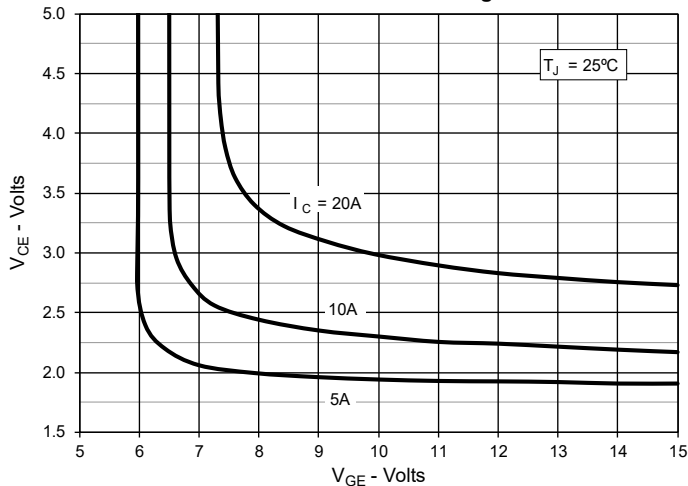
**Fig. 3. Output Characteristics @  $T_J = 125^\circ\text{C}$**



**Fig. 4. Dependence of  $V_{CE(sat)}$  on Junction Temperature**



**Fig. 5. Collector-to-Emitter Voltage vs. Gate-to-Emitter Voltage**



**Fig. 6. Input Admittance**

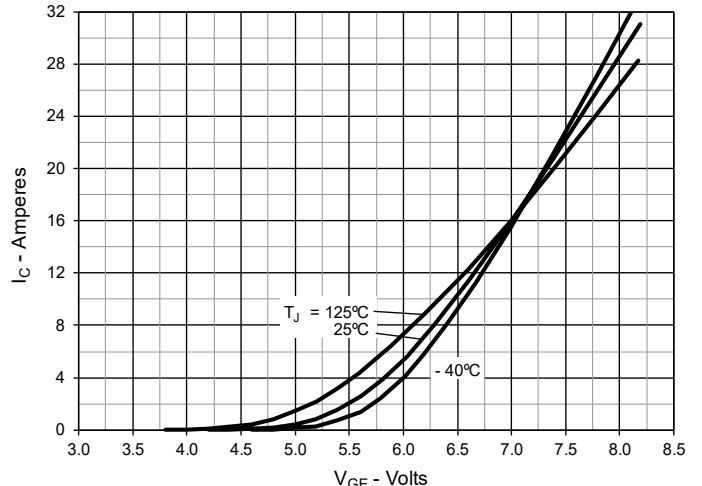


Fig. 7. Transconductance

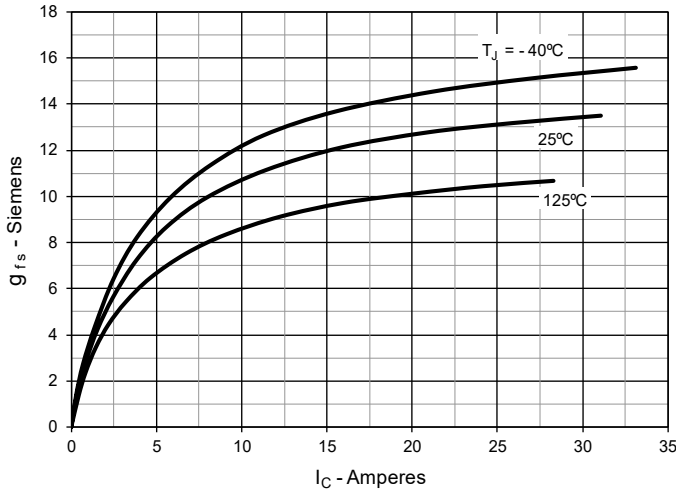


Fig. 8. Forward Voltage Drop of Intrinsic Diode

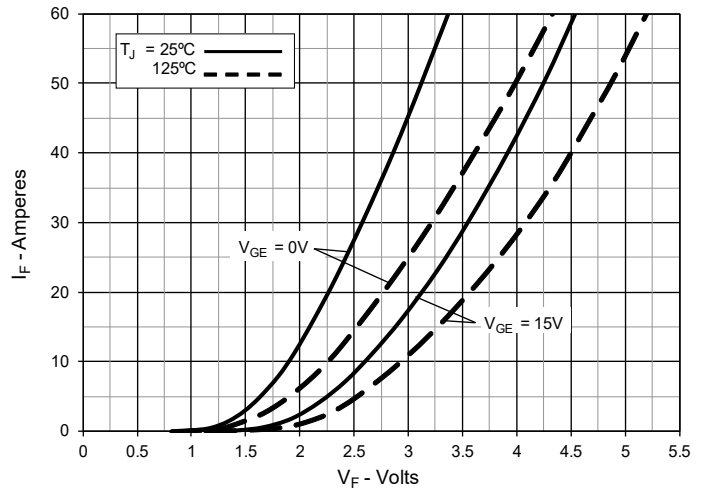


Fig. 9. Gate Charge

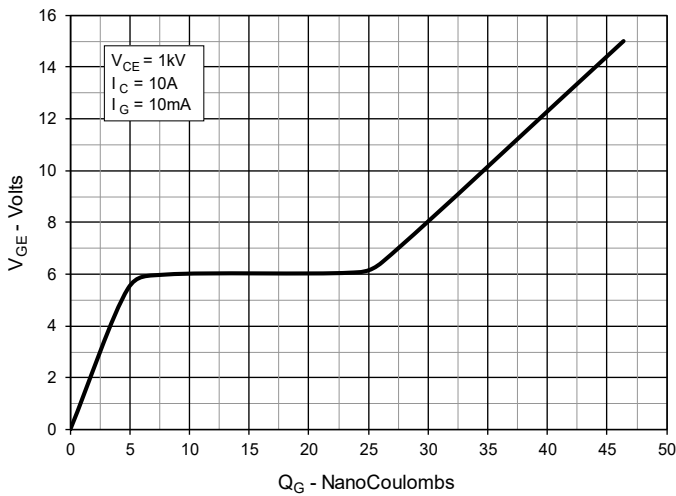


Fig. 10. Capacitance

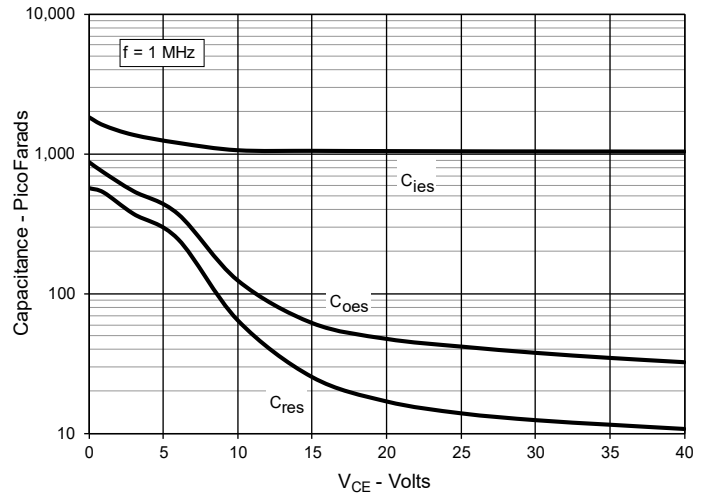


Fig. 11. Reverse-Bias Safe Operating Area

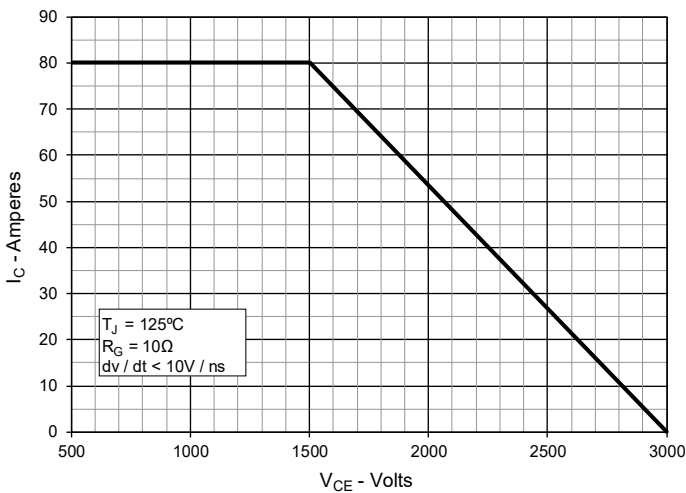
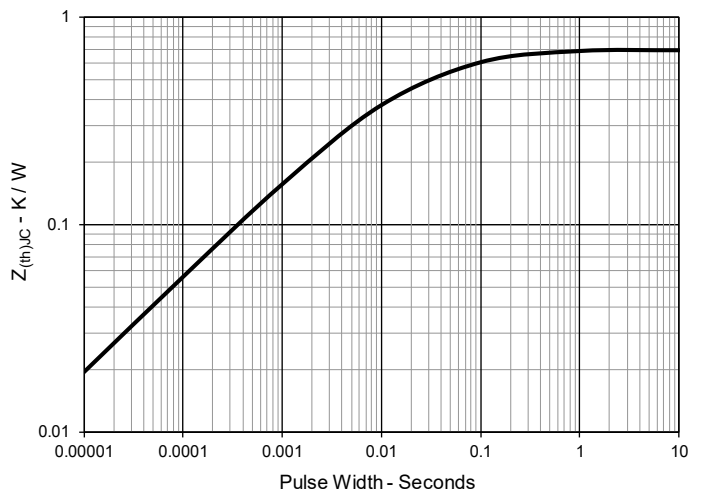
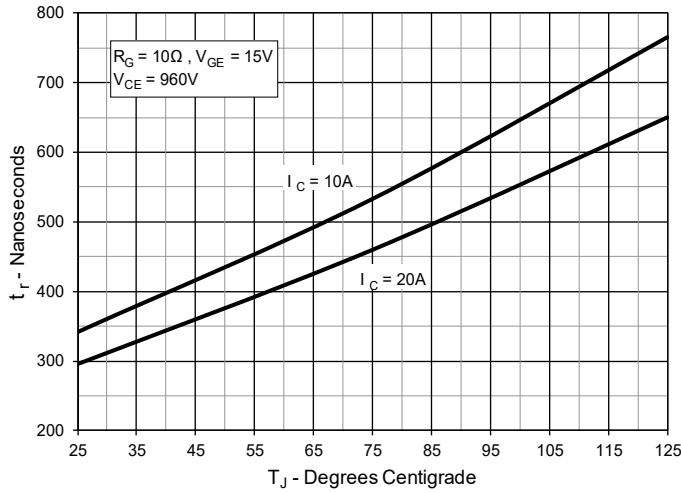


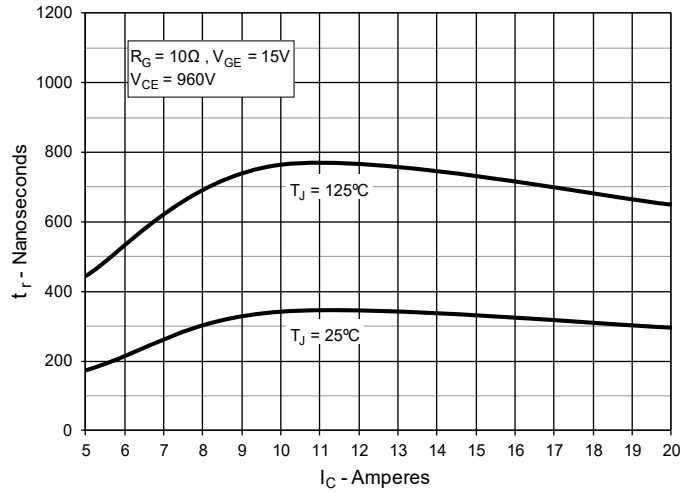
Fig. 12. Maximum Transient Thermal Impedance



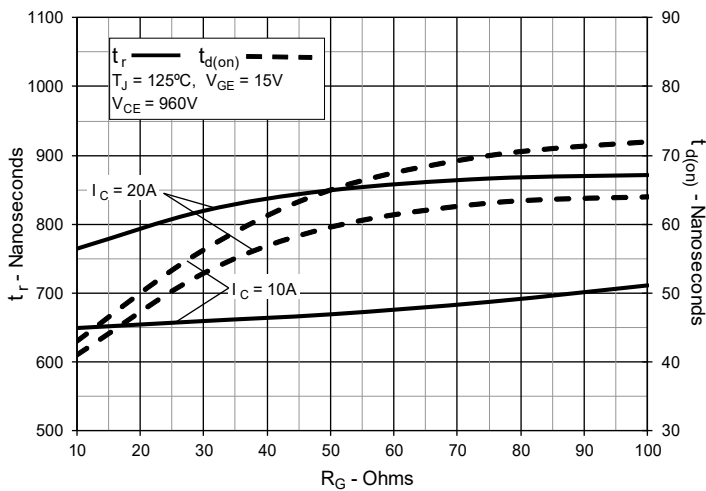
**Fig. 13. Resistive Turn-on Rise Time vs. Junction Temperature**



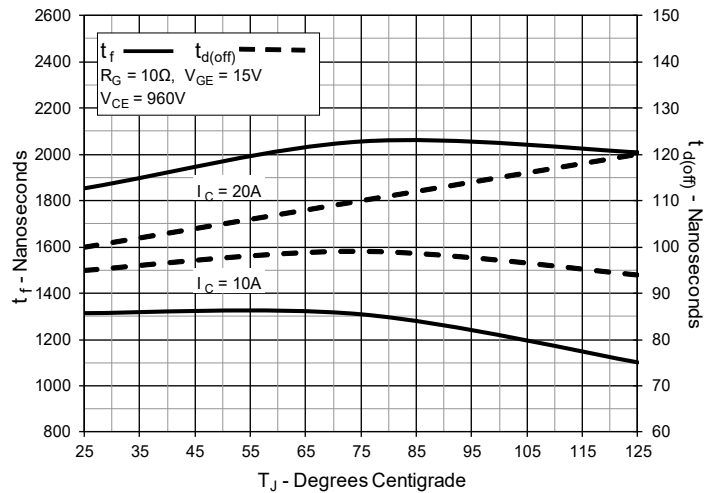
**Fig. 14. Resistive Turn-on Rise Time vs. Collector Current**



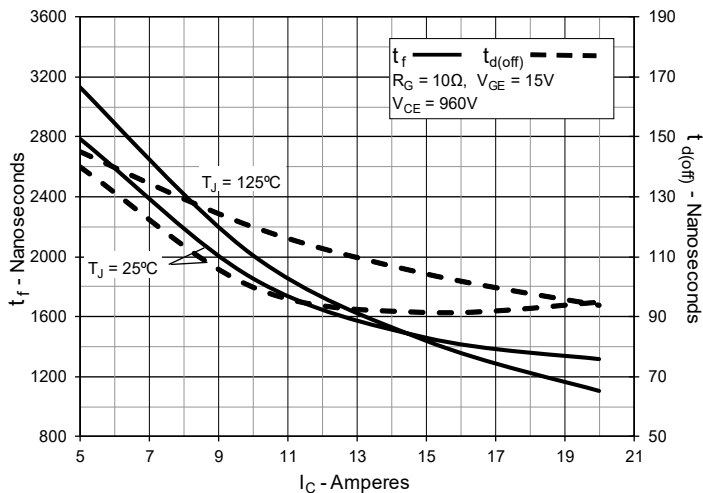
**Fig. 15. Resistive Turn-on Switching Times vs. Gate Resistance**



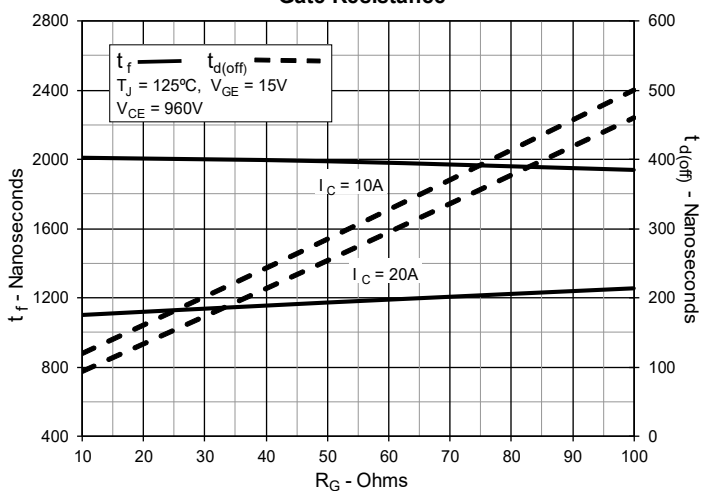
**Fig. 16. Resistive Turn-off Switching Times vs. Junction Temperature**



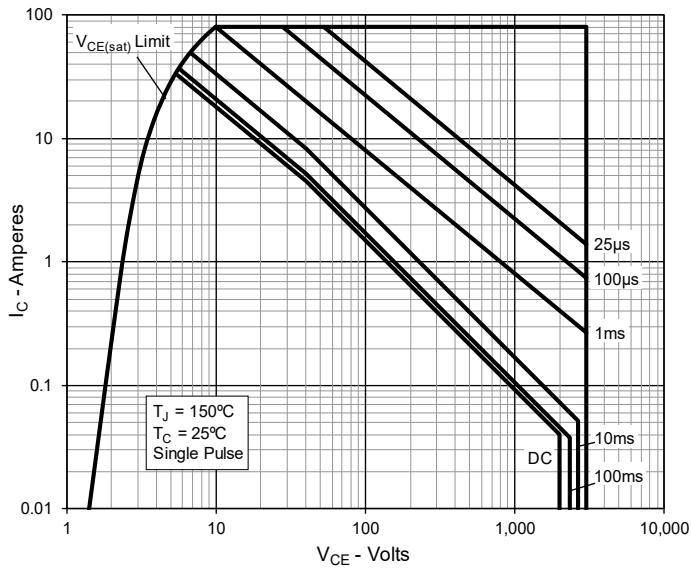
**Fig. 17. Resistive Turn-off Switching Times vs. Collector Current**



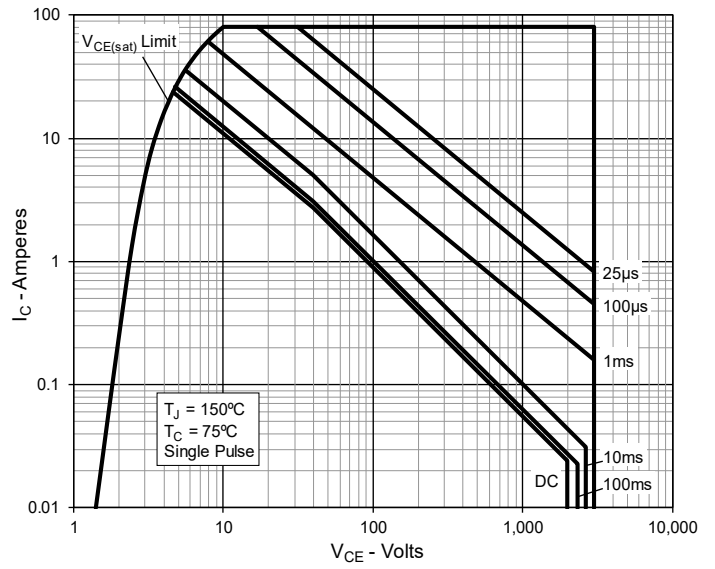
**Fig. 28. Resistive Turn-off Switching Times vs. Gate Resistance**

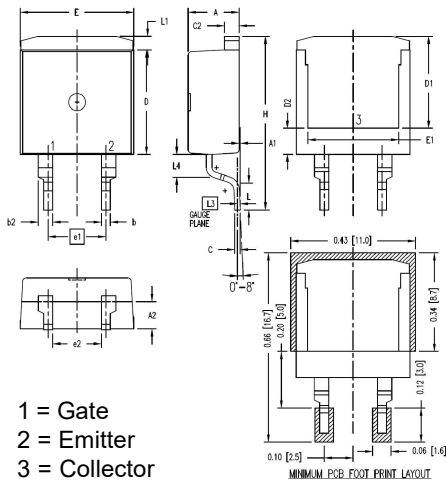


**Fig. 19. Forward-Bias Safe Operating Area  
@  $T_C = 25^\circ\text{C}$**

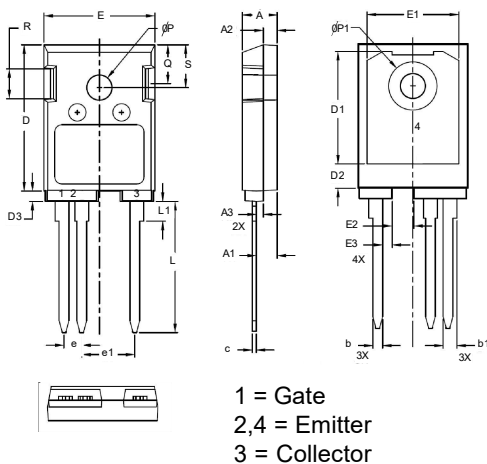


**Fig. 20. Forward-Bias Safe Operating Area  
@  $T_C = 75^\circ\text{C}$**



**TO-263HV Outline**


SYM	INCHES		MILLIMETER	
	MIN	MAX	MIN	MAX
A	.170	.185	4.30	4.70
A1	.000	.008	0.00	0.20
A2	.091	.098	2.30	2.50
b	.028	.035	0.70	0.90
b2	.046	.054	1.18	1.38
C	.018	.024	0.45	0.60
C2	.049	.055	1.25	1.40
D	.354	.370	9.00	9.40
D1	.311	.327	7.90	8.30
D2	.083	.098	2.10	2.50
E	.386	.402	9.80	10.20
E1	.307	.323	7.80	8.20
e1	.200	BSC	5.08	BSC
(e2)	.163	.174	4.13	4.43
H	.591	.614	15.00	15.60
L	.079	.102	2.00	2.60
L1	.039	.055	1.00	1.40
L3	.010	BSC	0.254	BSC
(L4)	.071	.087	1.80	2.20

**TO-247HV Outline**


SYM	INCHES		MILLIMETERS	
	MIN	MAX	MIN	MAX
A	.193	.201	4.90	5.10
A1	.114	.122	2.90	3.10
A2	.075	.083	1.90	2.10
A3	.035	.043	0.90	1.10
b	.053	.059	1.35	1.50
b1	.075	.083	1.90	2.10
c	.022	.030	0.55	0.75
D	.819	.843	20.80	21.40
D1	.638	.646	16.20	16.40
D2	.134	.146	3.40	3.70
D3	.055	.063	1.40	1.60
E	.622	.638	15.80	16.20
E1	.520	.528	13.20	13.40
E2	.118	.126	3.00	3.20
E3	.051	.059	1.30	1.50
e	.100	BSC	2.54	BSC
e1	.300	BSC	7.62	BSC
L	.724	.748	18.40	19.00
L1	.106	.118	2.70	3.00
øP	.138	.142	3.50	3.60
øP1	.272	.280	6.90	7.10
Q	.216	.224	5.50	5.70
R	.165	.169	4.20	4.30
S	.240	.248	6.10	6.30



---

Disclaimer Notice - Information furnished is believed to be accurate and reliable. However, users should independently evaluate the suitability of and test each product selected for their own applications. Littelfuse products are not designed for, and may not be used in, all applications. Read complete Disclaimer Notice at [www.littelfuse.com/disclaimer-electronics](http://www.littelfuse.com/disclaimer-electronics).

Littelfuse reserves the right to change limits, test conditions and dimensions.

---