

# OF CIRC. "XX"	"A"	"B"	"C"	"D"	MATERIAL NO. (STD)	MATERIAL NO. (-50 OPTION)
01	23.9 [1.94]	-	16.51 [1.650]	9.7 [1.381]	386906401	386907601
02	32.1 [1.27]	8.26 [1.325]	24.77 [1.975]	17.9 [1.711]	386906402	386907602
03	40.4 [1.59]	16.51 [1.650]	33.02 [1.300]	26.2 [1.031]	386906403	386907603
04	48.6 [1.92]	24.77 [1.975]	41.28 [1.625]	34.4 [1.361]	386906404	386907604
05	56.9 [2.24]	33.02 [1.300]	49.53 [1.950]	42.7 [1.681]	386906405	386907605
06	65.2 [2.57]	41.28 [1.625]	57.79 [2.275]	50.9 [2.011]	386906406	386907606
07	73.4 [2.89]	49.53 [1.950]	66.04 [2.600]	59.2 [2.331]	386906407	386907607
08	81.7 [3.22]	57.79 [2.275]	74.30 [2.925]	67.4 [2.661]	386906408	386907608
09	89.9 [3.54]	66.04 [2.600]	82.55 [3.250]	75.7 [2.981]	386906409	386907609
10	98.2 [3.87]	74.30 [2.925]	90.81 [3.575]	83.9 [3.311]	386906410	386907610
11	106.4 [4.19]	82.55 [3.250]	99.06 [3.900]	92.2 [3.631]	386906411	386907611
12	114.7 [4.52]	90.81 [3.575]	107.32 [4.225]	100.5 [3.961]	386906412	386907612
13	122.9 [4.84]	99.06 [3.900]	115.57 [4.550]	108.7 [4.281]	386906413	386907613
14	131.2 [5.17]	107.32 [4.225]	123.83 [4.875]	117.0 [4.611]	386906414	386907614
15	139.4 [5.49]	115.57 [4.550]	132.08 [5.200]	125.2 [4.931]	386906415	386907615
16	147.7 [5.82]	123.83 [4.875]	140.34 [5.525]	133.5 [5.261]	386906416	386907616
17	156.0 [6.14]	132.08 [5.200]	148.59 [5.850]	141.7 [5.581]	386906417	386907617
18	164.2 [6.47]	140.34 [5.525]	156.85 [6.175]	150.0 [5.911]	386906418	386907618
19	172.5 [6.79]	148.59 [5.850]	165.10 [6.500]	158.2 [6.231]	386906419	386907619
20	180.7 [7.12]	156.85 [6.175]	173.36 [6.825]	166.5 [6.561]	386906420	386907620
21	189.0 [7.44]	165.10 [6.500]	181.61 [7.150]	174.8 [6.881]	386906421	386907621
22	197.2 [7.77]	173.36 [6.825]	189.87 [7.475]	183.0 [7.211]	386906422	386907622
23	205.5 [8.09]	181.61 [7.150]	198.12 [7.800]	191.3 [7.531]	386906423	386907623
24	213.7 [8.42]	189.87 [7.475]	206.38 [8.125]	199.5 [7.861]	386906424	386907624
25	222.0 [8.74]	198.12 [7.800]	214.63 [8.450]	207.8 [8.181]	386906425	386907625
26	230.3 [9.07]	206.38 [8.125]	222.89 [8.775]	216.0 [8.511]	386906426	386907626
27	238.5 [9.39]	214.63 [8.450]	231.14 [9.100]	224.3 [8.831]	386906427	386907627
28	246.8 [9.72]	222.89 [8.775]	239.40 [9.425]	232.5 [9.161]	386906428	386907628
29	255.0 [10.04]	231.14 [9.100]	247.65 [9.750]	240.8 [9.481]	386906429	386907629
30	263.3 [10.37]	239.40 [9.425]	255.91 [10.075]	249.0 [9.811]	386906430	386907630
31	271.5 [10.69]	247.65 [9.750]	264.16 [10.400]	257.3 [10.131]	386906431	386907631
32	279.8 [11.02]	255.91 [10.075]	272.42 [10.725]	265.6 [10.461]	386906432	386907632

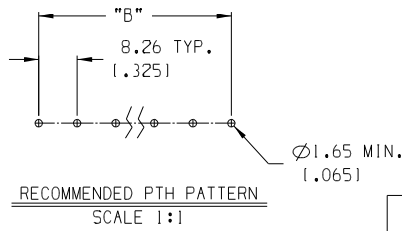
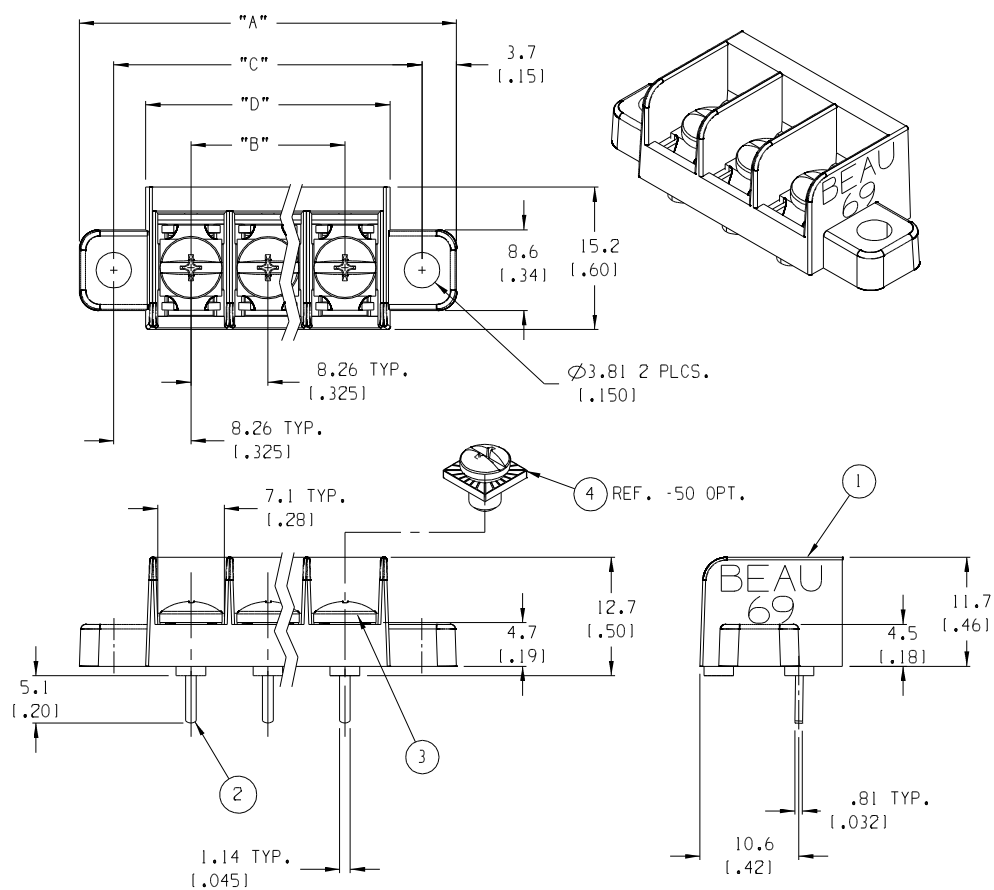

NOTES:

1. MATERIAL: SEE TABLE
2. FINISHES: SEE TABLE
3. PRODUCT SPECIFICATION: NOT REQUIRED
4. PACKAGING: NOT REQUIRED
5. MATES WITH: NONE
6. "XX" REFERS TO THE QUANTITY OF CIRCUITS.

ITEM	QTY.	DESCRIPTION	MATERIAL	FINISH
4	XX	SCREW, #6-32X.250, PAN HD, W/ SO. WASHER, -50 OPT.	STEEL	ZN, CLEAR CHROMATE
3	XX	SCREW, #6-32X.250, PAN HD, PHIL-SLOT	BRASS	NICKEL PLATE
2	XX	TERMINAL, PC	BRASS	TIN PLATE
1	1	INSULATOR, SR, CS, MOLDED MTG.	VALOX	BLACK

EC NO. RELEASED DRWIN: CLY CH: K1 APPR:	DESCRIPTION MAJOR CRITICAL SPC S	QUALITY SYMBOLS	GENERAL TOLERANCES: (UNLESS SPECIFIED) mm INCH 4 PLACES ±.0015 3 PLACES ±.038 ±.005 2 PLACES ±.13 ±.01 1 PLACE ±.3	SCALE 2:1 DESIGN UNITS <input type="checkbox"/> mm <input checked="" type="checkbox"/> INCH	THIRD ANGLE PROJECTION	DIMENSIONS: <input checked="" type="checkbox"/> mm <input type="checkbox"/> INCH <input type="checkbox"/> mm ONLY	SHT REV REVISE ON CAD ONLY
		DRAWN BY & DATE C. YORK 05-28-05	CHECKED BY & DATE	APPROVED BY & DATE	TITLE: 8.26mm [1.325"] SR BTS, CS, PC ASSY	MOLEX INCORPORATED	
		CAD FILENAME 695XX	MATERIAL NO. SEE CHART	DRAWING NO. SD-38690-002	SHEET NO. 1 OF 1	THIS DRAWING CONTAINS INFORMATION THAT IS PROPRIETARY TO MOLEX INCORPORATED AND SHOULD NOT BE USED WITHOUT WRITTEN PERMISSION.	
		DRAFT WHERE APPLICABLE MUST REMAIN WITHIN DIMENSIONS	SIZE B				