

Wide-band, dual-path directional coupler with integrated 50 ohm loaded isolated port

Datasheet – production data

Features

- 50 Ω nominal input / output impedance
- Wide operating frequency range:
 - 2400 MHz-5850 MHz
- Low insertion loss
- High ESD ruggedness
- Lead-free CSP
- Small footprint: 1670 x 1440 μm
- Very low profile (< 600 μm after reflow)

Benefits

- High RF performance
- RF module size reduction

Applications

Multi-band equipment such as:

- Power amplifier module
- Front end module
- WLAN

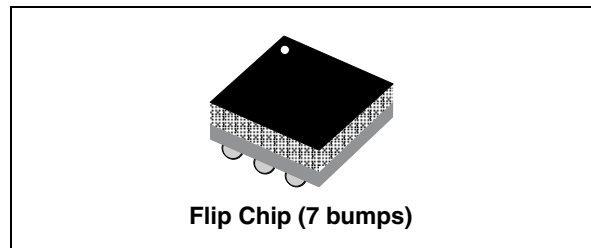
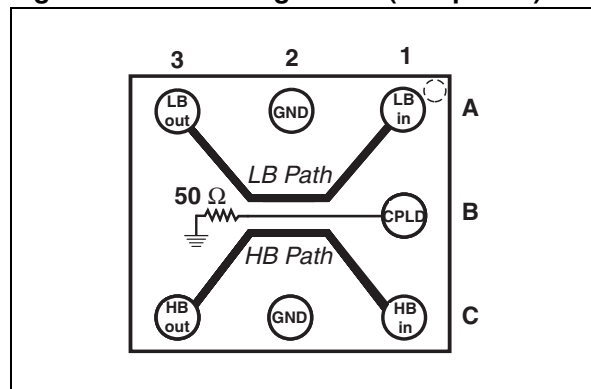

Figure 1. Pin configuration (bump view)



Description

The DCPL-WB-02D3 is a wide-band, dual-path directional coupler designed to measure transmission output power in WLAN applications. This dual path CPL has been customized for wide-band operating frequencies (2G/5G WLAN) with low insertion losses in the transmission bandwidth (2400 MHz - 5850 MHz).

This device is built with two different RF couplers (one dedicated to LB, the other dedicated to HB) sharing the same coupled ports. Isolated port is loaded with an integrated 50 Ω resistor.

The DCPL-WB-02D3 has been designed using STMicroelectronics IPD (integrated passive device) technology on non-conductive glass substrate to optimize RF performance. The device is delivered 100% tested in tape and reel.

1 Characteristics

Table 1. Absolute maximum rating (limiting values)

Symbol	Parameter	Value			Unit
		Min.	Typ.	Max.	
P_{IN}	Input Power RF_{IN} (CW mode)			25	dBm
V_{ESD} (HBM)	Human body model, JESD 22-A114F, all I/O	2			kV
V_{ESD} (MM)	Machine model, JESD 22-A115-A, all I/O	100			V
V_{ESD} (CDM)	Charge device model, JESD 22-C101-C, all I/O	500			V
T_{OP}	Operating temperature	-30		+85	°C

Table 2. Electrical characteristics - impedances ($T_{amb} = 25\text{ °C}$)

Symbol	Parameter	Value			Unit
		Min.	Typ.	Max.	
Z_{OUT}	Nominal output impedance (LB and HB paths)		50		Ω
Z_{IN}	Nominal input impedance (LB and HB paths)		50		Ω
Z_{CPL}	Nominal coupled port impedance		50		Ω

Table 3. Electrical characteristics - LB WLAN path RF performance ($T_{amb} = 25\text{ °C}$)

Symbol	Parameter	Test condition	Value			Unit
			Min.	Typ.	Max.	
f	Frequency range (bandwidth)		2400	2450	2500	MHz
IL _{LB}	LB path insertion loss	From 2400 MHz to 2500 MHz			0.2	dB
RL _{LB}	LB path return loss (IN, OUT pins)	From 2400 MHz to 2500 MHz	15			dB
CPLD _{LB}	LB path coupling factor	at 2.45 GHz	17	18	19	dB
Ripple _{LB}	Coupling ripple in LB	From 2400 MHz to 2500 MHz			0.5	dB

Table 4. Electrical characteristics - HB WLAN path RF performance ($T_{amb} = 25\text{ °C}$)

Symbol	Parameter	Test condition	Value			Unit
			Min.	Typ.	Max.	
f	Frequency range (bandwidth)		4900	5375	5850	MHz
IL _{HB}	HB path insertion loss	From 4900 MHz to 5850 MHz			0.5	dB
RL _{HB}	HB path return loss (IN, OUT pins)	From 4900 MHz to 5850 MHz	15			dB
CPLD _{HB}	HB path coupling factor	at 5.375 GHz	11	12	13	dB
Ripple _{HB}	Coupling ripple in HB	From 4900 MHz to 5850 MHz			1.2	dB

2 PCB recommendation

Figure 2. Recommended land pattern

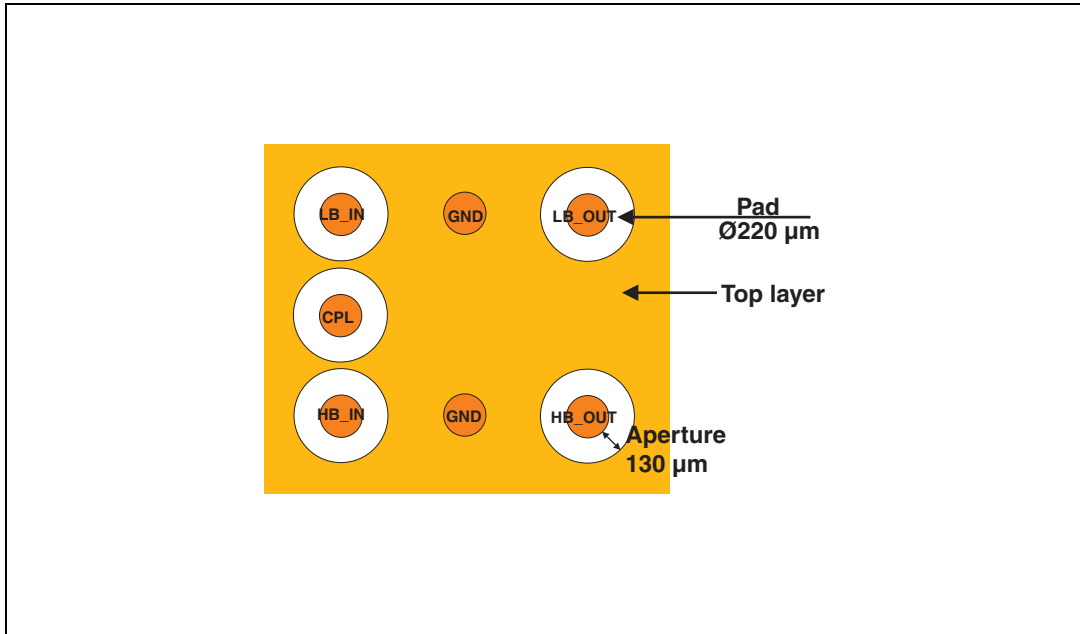

3 Ordering information scheme

Figure 3. Ordering information scheme

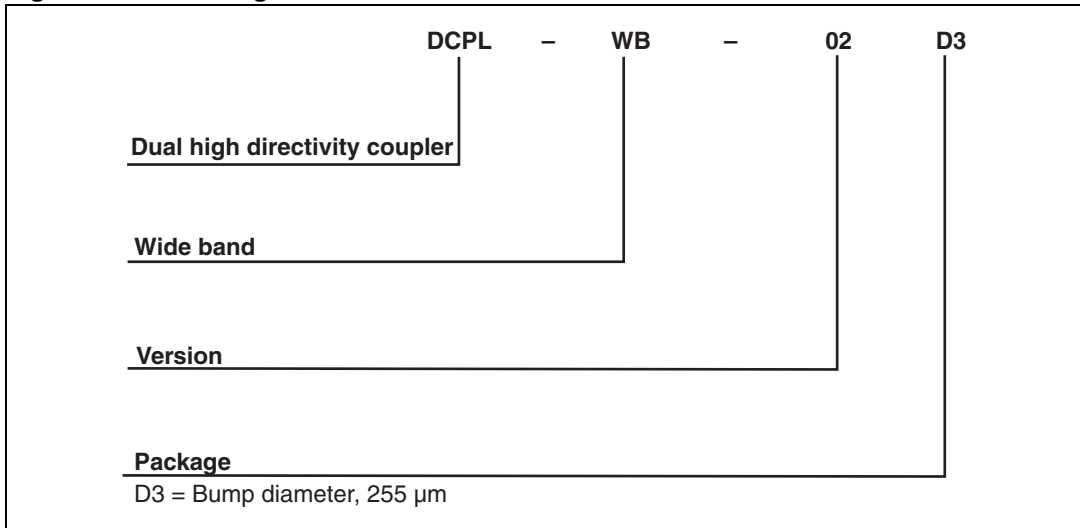

4 Package information

In order to meet environmental requirements, ST offers these devices in different grades of ECOPACK® packages, depending on their level of environmental compliance. ECOPACK® specifications, grade definitions and product status are available at: www.st.com. ECOPACK® is an ST trademark.

Figure 4. Package dimensions

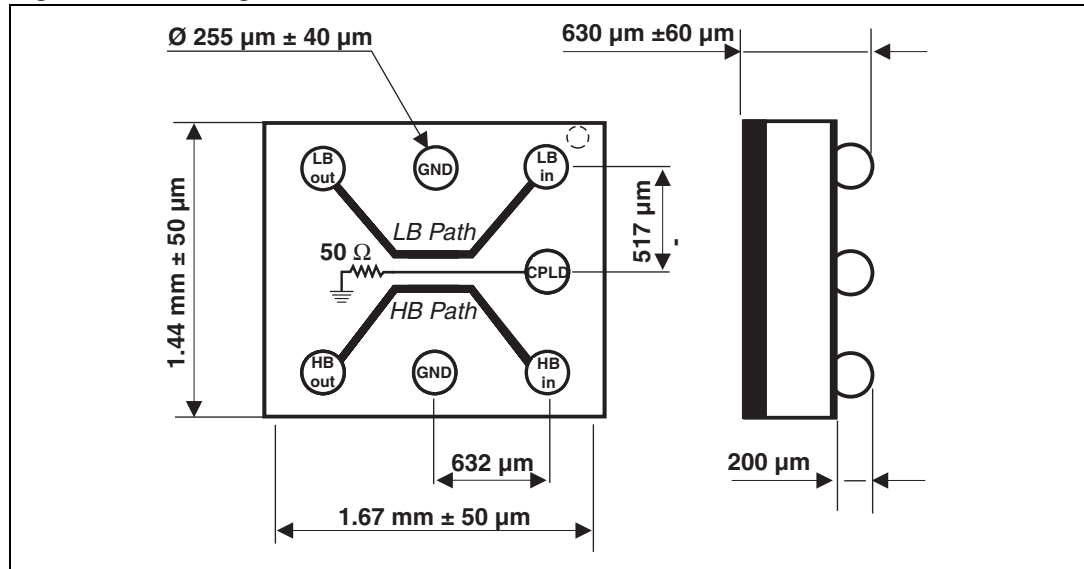

Figure 5. Footprint

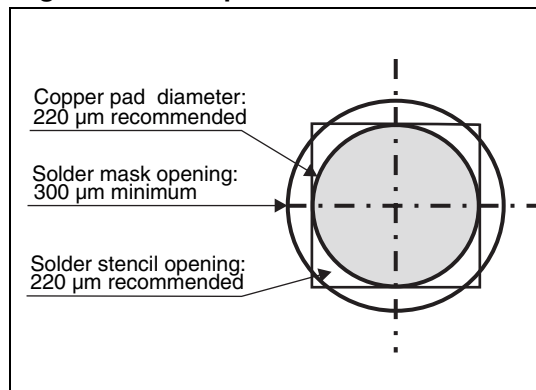

Figure 6. Marking

Dot, ST logo
 □ ECOPACK status
 xx = marking
 z = manufacturing location
 yww = datecode
 (y = year
 ww = week)

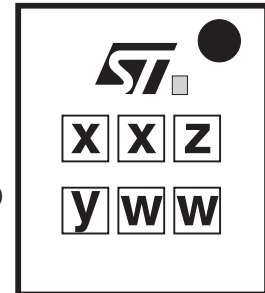
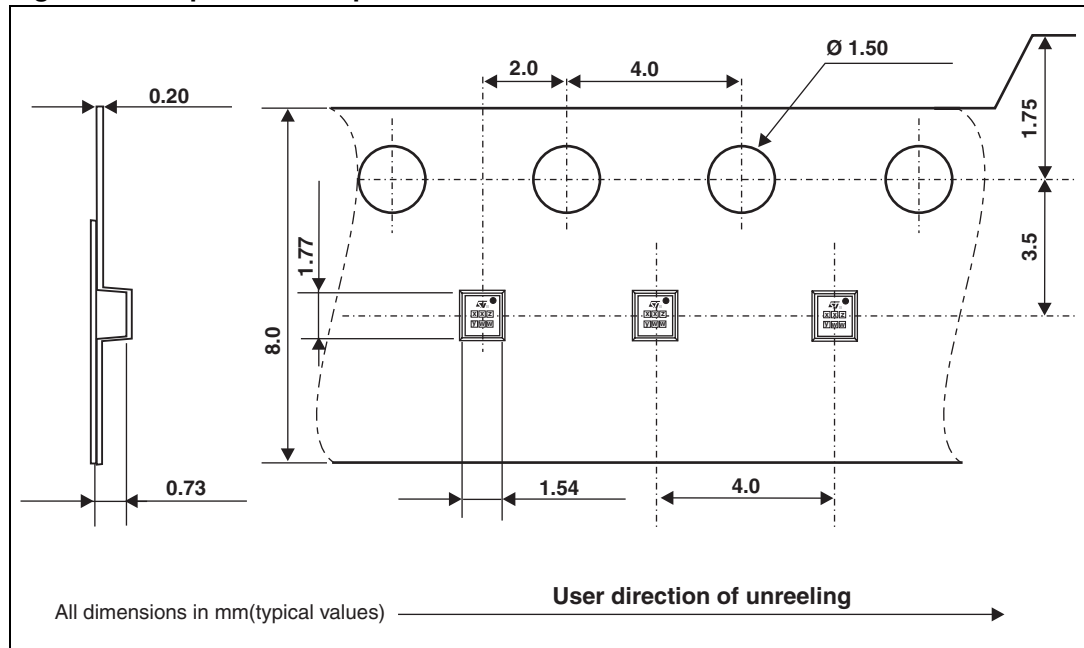

Figure 7. Tape and reel specifications



Note: More packing information is available in the STMicroelectronics Application notes:
AN2348: "IPAD™ 400 μm Flip Chip: package description and recommendations for use"
AN1751: "EMI Filters: recommendations and measurements"

5 Ordering information

Table 5. Ordering information

Order code	Marking	Package	Weight	Base qty	Delivery mode
DCPL-WB-02D3	SF	Flip Chip	2.5 mg	5000	Tape and reel 7"

6 Revision history

Table 6. Document revision history

Date	Revision	Changes
18-Jun-2012	1	Initial release

Please Read Carefully:

Information in this document is provided solely in connection with ST products. STMicroelectronics NV and its subsidiaries ("ST") reserve the right to make changes, corrections, modifications or improvements, to this document, and the products and services described herein at any time, without notice.

All ST products are sold pursuant to ST's terms and conditions of sale.

Purchasers are solely responsible for the choice, selection and use of the ST products and services described herein, and ST assumes no liability whatsoever relating to the choice, selection or use of the ST products and services described herein.

No license, express or implied, by estoppel or otherwise, to any intellectual property rights is granted under this document. If any part of this document refers to any third party products or services it shall not be deemed a license grant by ST for the use of such third party products or services, or any intellectual property contained therein or considered as a warranty covering the use in any manner whatsoever of such third party products or services or any intellectual property contained therein.

UNLESS OTHERWISE SET FORTH IN ST'S TERMS AND CONDITIONS OF SALE ST DISCLAIMS ANY EXPRESS OR IMPLIED WARRANTY WITH RESPECT TO THE USE AND/OR SALE OF ST PRODUCTS INCLUDING WITHOUT LIMITATION IMPLIED WARRANTIES OF MERCHANTABILITY, FITNESS FOR A PARTICULAR PURPOSE (AND THEIR EQUIVALENTS UNDER THE LAWS OF ANY JURISDICTION), OR INFRINGEMENT OF ANY PATENT, COPYRIGHT OR OTHER INTELLECTUAL PROPERTY RIGHT.

UNLESS EXPRESSLY APPROVED IN WRITING BY TWO AUTHORIZED ST REPRESENTATIVES, ST PRODUCTS ARE NOT RECOMMENDED, AUTHORIZED OR WARRANTED FOR USE IN MILITARY, AIR CRAFT, SPACE, LIFE SAVING, OR LIFE SUSTAINING APPLICATIONS, NOR IN PRODUCTS OR SYSTEMS WHERE FAILURE OR MALFUNCTION MAY RESULT IN PERSONAL INJURY, DEATH, OR SEVERE PROPERTY OR ENVIRONMENTAL DAMAGE. ST PRODUCTS WHICH ARE NOT SPECIFIED AS "AUTOMOTIVE GRADE" MAY ONLY BE USED IN AUTOMOTIVE APPLICATIONS AT USER'S OWN RISK.

Resale of ST products with provisions different from the statements and/or technical features set forth in this document shall immediately void any warranty granted by ST for the ST product or service described herein and shall not create or extend in any manner whatsoever, any liability of ST.

ST and the ST logo are trademarks or registered trademarks of ST in various countries.

Information in this document supersedes and replaces all information previously supplied.

The ST logo is a registered trademark of STMicroelectronics. All other names are the property of their respective owners.

© 2012 STMicroelectronics - All rights reserved

STMicroelectronics group of companies

Australia - Belgium - Brazil - Canada - China - Czech Republic - Finland - France - Germany - Hong Kong - India - Israel - Italy - Japan - Malaysia - Malta - Morocco - Philippines - Singapore - Spain - Sweden - Switzerland - United Kingdom - United States of America

www.st.com