

DKSV210

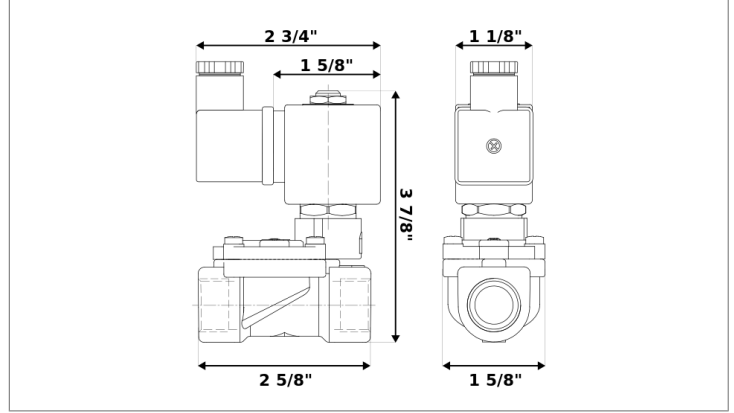

Normally closed, pilot operated, 2-way solenoid valve with brass body and 1/2" connections



Valve	
Pipe size:	1/2" NPT
Operating pressure:	3–230 psi
Flow coefficient:	4.9 Cv
Media temperature:	15–195 °F
Ambient temperature:	15–105 °F
Suggested usage:	Air, inert gas, water
Operation:	2-way, normally closed solenoid valve
Mechanism:	Pilot operated
Manual override:	No
Pipe gender:	Female
Orifice size:	1/2"
Design pressure:	360 psi
Media viscosity:	12 cSt

Electrical	
Power:	24 V dc
Wattage:	8 W
Connection:	Cable gland (PG9)
Consumption:	0.33 A
Voltage tolerances:	+10% -5%
Coil inner diameter:	1/2"
Coil molding:	Polyamide (PA)
Coil rating:	15–310 °F (Class F)
Duty cycle:	Continuous, 100% ED
Enclosure:	NEMA 4, IP65

Materials	
Body:	Brass
Seal:	Buna-N rubber (NBR)
Orifice:	Brass
Core tube:	Stainless steel 300
Fixed core:	Stainless steel 400
Plunger:	Stainless steel 400
Spring:	Stainless steel 300
Shading ring:	Copper

Spare parts		
CORE TUBE	REPAIR KIT	COIL/CONNECTOR
AT-A001	RK-W001	C-D29
		
<ul style="list-style-type: none"> Core tube Plunger 	<ul style="list-style-type: none"> Diaphragm O-ring Plunger 	<ul style="list-style-type: none"> 24 V dc electrical coil Cable gland connector