

## SUMMARY

### # Wires

Low voltage 4



Image is for illustrative purpose only

Series	1B
Termination type	Male solder
IP rating	50
AWG wire size	30.00 - 22.00
Cable Ø	4.30 - 5.20 mm
Status	active
Matching parts	<a href="#">EGG.1B.304.CLL</a> <a href="#">PHG.1B.304.CLLD52</a>

### Download

- [Request a quote](#)
- [Eplan](#)
- [Catalog](#)
- [See video assembly instructions](#)

## TECHNICAL DETAILS

### Mechanics

Shell Style/Model	FG*: Straight plug, cable collet
Keying	1 key (alpha=0, plug: male contacts, receptacle: female contacts)
Housing Material	Brass (chrome plated [SAE AMS 2460]) shell and collet nut, nickel plated [SAE AMS QQ N 290] brass latch sleeve and mid pieces
Weight	16.05 g

### Performance

Configuration	1B.304 : 4 Low Voltage
Insulator	L: PEEK (UL 94 / V-0/1.5)
Rated Current	10 Amps

### Specifications

- Contact Type: Solder
- Contact Dia.: 0.9 mm (0.035in)
- Bucket Dia.: 0.8 mm (0.031in)
- Max. Solid Conductor: 0.34 mm<sup>2</sup> (AWG 22)
- Max. Stranded Conductor: 0.34 mm<sup>2</sup> (AWG 22)
- R (max): 4.8 mOhm
- Vtest (contact-shell): 1450 V (AC), 2050 V (DC)
- Vtest (contact-contact): 1350 V (AC), 1910 V (DC)

LEMO products and services are provided "as is". LEMO makes no warranties or representations with regard to LEMO product & services or use of them, express, implied or statutory, including for accuracy, completeness, or security. The user is fully responsible for his products and applications using LEMO components.

## Others

Endurance (Shell): 5000  
Temp (min / max): -55° C / +250° C  
Humidity (max): <=95% [at 60 deg C / 140 F]  
Vibration: 15 g [10 Hz - 2000 Hz]  
Shock Resistance: 100 g [ 6 ms]  
Climatical Category: 50/175/21  
Shielding (min): 75 dB (10 MHz)  
Shielding (min): 40 dB (1 GHz)  
Salt Spray Corrosion: >1000 hr

## DRAWINGS

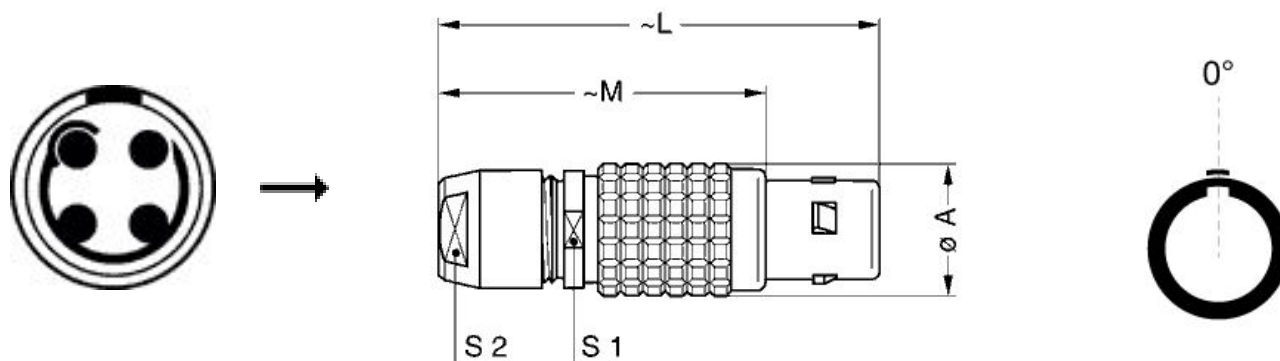

## Dimensions

	A	L	M	S1	S2
mm.	12	43	32	10	9
in.	0,47	1,69	1,26	0,39	0,35

## RECOMMENDED BY LEMO







### Tools

Spanner wrench: [DCD.1B.ZZZ.PA090](#)

Caps: [BFG.1B.100.PCSG](#)

*LEMO products and services are provided "as is". LEMO makes no warranties or representations with regard to LEMO product & services or use of them, express, implied or statutory, including for accuracy, completeness, or security. The user is fully responsible for his products and applications using LEMO components.*

## Cables

CMN.04.T22.047QGC	TPR	Grey	
CMN.04.T22.048QGZE	TPR (medical)	Grey	
140240	PVC	Black	
140250	PVC	Grey	
40260	PVC	Black	
4080	PVC	Grey	
4221	PVC	Black	
4280	PVC	Black	
80080	PVC	Grey	
80082	PVC	Red	
80084	PVC	Black	

LEMO products and services are provided "as is". LEMO makes no warranties or representations with regard to LEMO product & services or use of them, express, implied or statutory, including for accuracy, completeness, or security. The user is fully responsible for his products and applications using LEMO components.