

## N-Channel Enhancement Mode Power MOSFET

### Description

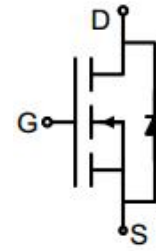
The G3404LL uses advanced trench technology to provide excellent  $R_{DS(ON)}$ , low gate charge. It can be used in a wide variety of applications.

### General Features

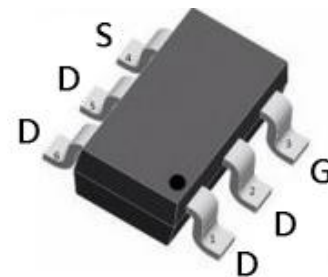
- $V_{DS}$  30V
- $I_D$  (at  $V_{GS} = 10V$ ) 6A
- $R_{DS(ON)}$  (at  $V_{GS} = 10V$ ) < 22m $\Omega$
- $R_{DS(ON)}$  (at  $V_{GS} = 4.5V$ ) < 35m $\Omega$
- 100% Avalanche Tested
- RoHS Compliant

### Application

- Power switch
- DC/DC converters



Schematic diagram



SOT-23-6L

### Ordering Information

Device	Package	Marking	Packaging
G3404LL	SOT-23-6	G3404	3000psc/Reel

### Absolute Maximum Ratings $T_C = 25^\circ C$ , unless otherwise noted

Parameter	Symbol	Value	Unit
Drain-Source Voltage	$V_{DS}$	30	V
Continuous Drain Current	$I_D$	6	A
Pulsed Drain Current (note1)	$I_{DM}$	24	A
Gate-Source Voltage	$V_{GS}$	$\pm 20$	V
Power Dissipation	$P_D$	1.2	W
Operating Junction and Storage Temperature Range	$T_J, T_{stg}$	-55 To 150	$^\circ C$

### Thermal Resistance

Parameter	Symbol	Value	Unit
Thermal Resistance, Junction-to-Ambient	$R_{thJA}$	104	$^\circ C/W$

Specifications $T_J = 25^\circ\text{C}$ , unless otherwise noted						
Parameter	Symbol	Test Conditions	Value			Unit
			Min.	Typ.	Max.	
<b>Static Parameters</b>						
Drain-Source Breakdown Voltage	$V_{(BR)DSS}$	$V_{GS} = 0V, I_D = 250\mu A$	30	--	--	V
Zero Gate Voltage Drain Current	$I_{DSS}$	$V_{DS} = 30V, V_{GS} = 0V$	--	--	1	$\mu A$
Gate-Source Leakage	$I_{GSS}$	$V_{GS} = \pm 20V$	--	--	$\pm 100$	nA
Gate-Source Threshold Voltage	$V_{GS(th)}$	$V_{DS} = V_{GS}, I_D = 250\mu A$	1	1.5	2	V
Drain-Source On-Resistance	$R_{DS(on)}$	$V_{GS} = 10V, I_D = 4.2A$	--	16	22	m $\Omega$
		$V_{GS} = 4.5V, I_D = 4A$	--	23	35	
Forward Transconductance	$g_{FS}$	$V_{GS} = 5V, I_D = 4.2A$	--	12	--	S
<b>Dynamic Parameters</b>						
Input Capacitance	$C_{iss}$	$V_{GS} = 0V,$ $V_{DS} = 15V,$ $f = 1.0MHz$	--	541	--	pF
Output Capacitance	$C_{oss}$		--	70	--	
Reverse Transfer Capacitance	$C_{rss}$		--	55	--	
Total Gate Charge	$Q_g$	$V_{DD} = 15V,$ $I_D = 4.2A,$ $V_{GS} = 10V$	--	12.2	--	nC
Gate-Source Charge	$Q_{gs}$		--	2.4	--	
Gate-Drain Charge	$Q_{gd}$		--	2.3	--	
Turn-on Delay Time	$t_{d(on)}$	$V_{DD} = 15V,$ $I_D = 4.2A,$ $R_G = 3\Omega$	--	28	--	ns
Turn-on Rise Time	$t_r$		--	5	--	
Turn-off Delay Time	$t_{d(off)}$		--	22	--	
Turn-off Fall Time	$t_f$		--	13	--	
<b>Drain-Source Body Diode Characteristics</b>						
Continuous Body Diode Current	$I_S$	$T_C = 25^\circ\text{C}$	--	--	6	A
Body Diode Voltage	$V_{SD}$	$T_J = 25^\circ\text{C}, I_{SD} = 4.2A, V_{GS} = 0V$	--	--	1.2	V
Reverse Recovery Charge	$Q_{rr}$	$I_F = 4.2A, V_{GS} = 0V$ $di/dt = 100A/\mu s$	--	2.6	--	nC
Reverse Recovery Time	$T_{rr}$		--	8.5	--	ns

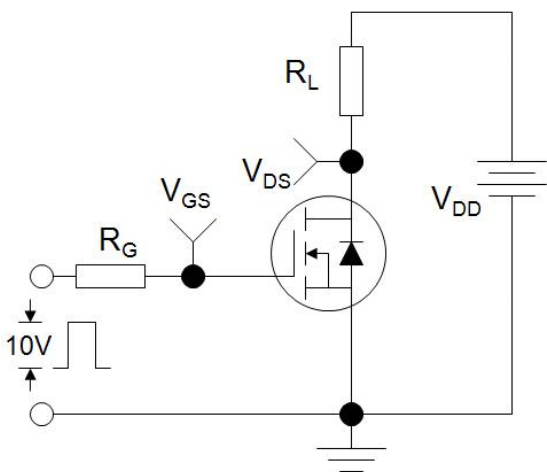
### Notes

1. Repetitive Rating: Pulse width limited by maximum junction temperature
2. Identical low side and high side switch with identical  $R_G$

### Gate Charge Test Circuit



### Switch Time Test Circuit

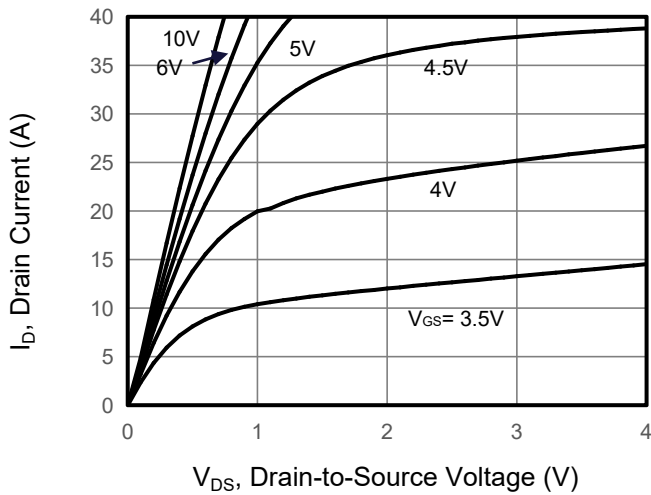


### EAS Test Circuit

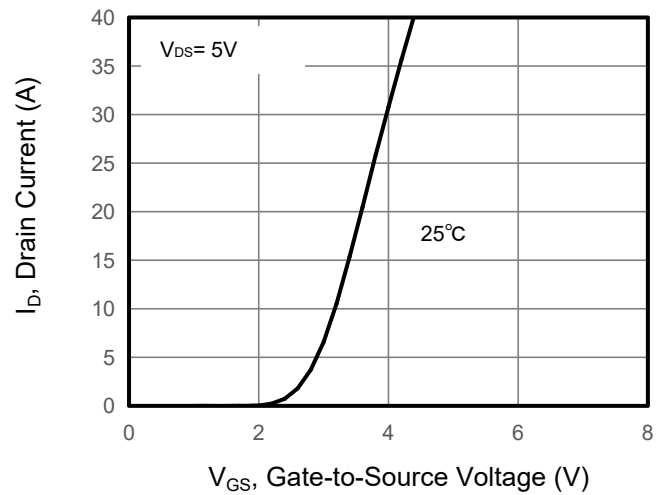


Typical Characteristics  $T_J = 25^\circ\text{C}$ , unless otherwise noted

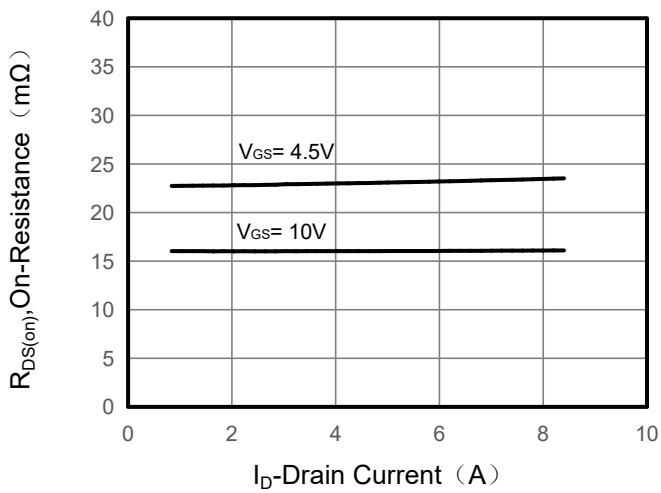
**Figure 1. Output Characteristics**



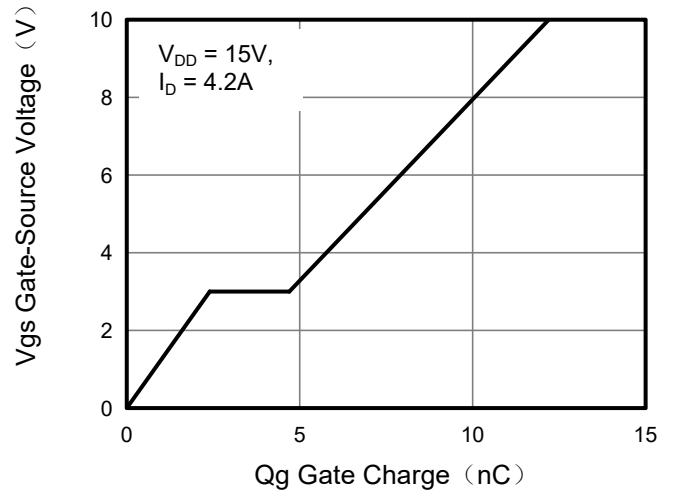
**Figure 2. Transfer Characteristics**



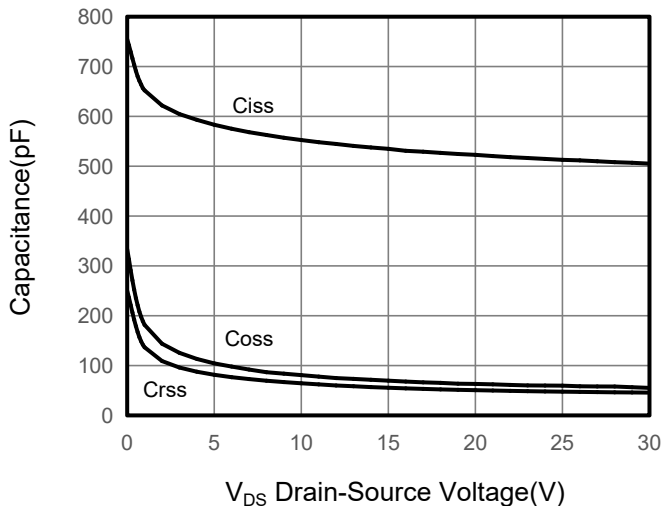
**Figure 3. Drain Source On Resistance**



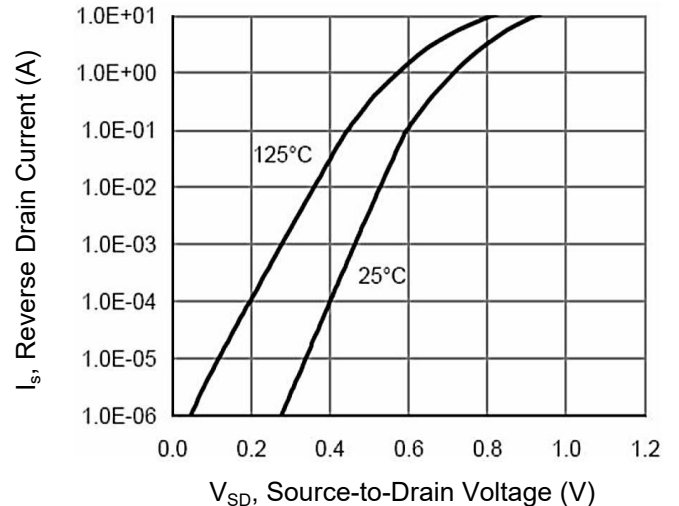
**Figure 4. Gate Charge**



**Figure 5. Capacitance**

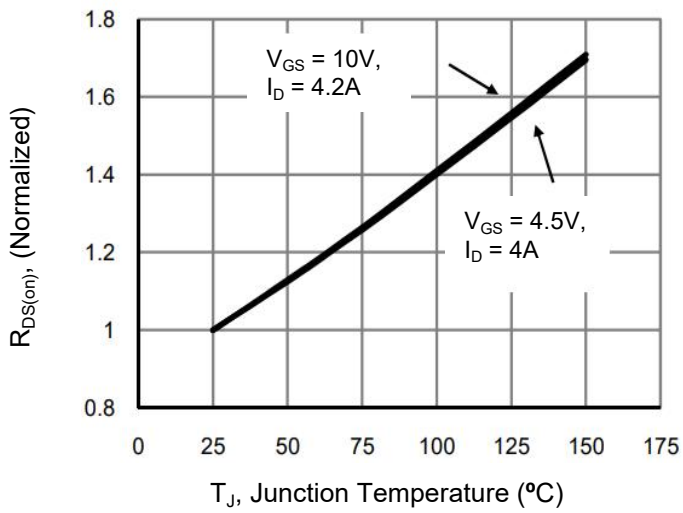


**Figure 6. Source-Drain Diode Forward**

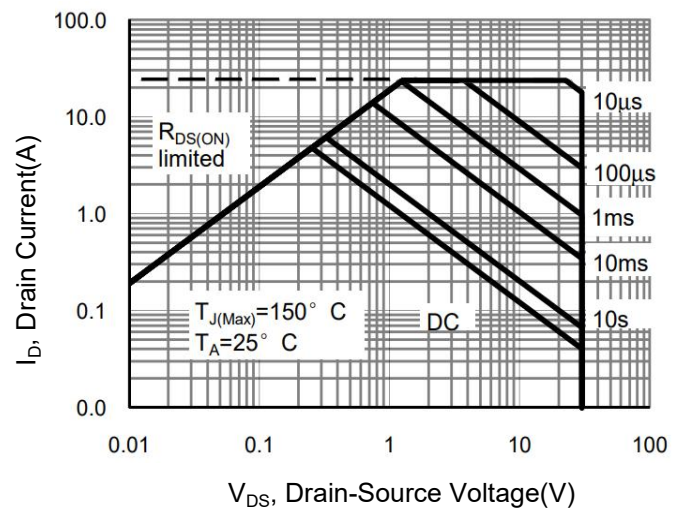


## Typical Characteristics $T_J = 25^\circ\text{C}$ , unless otherwise noted

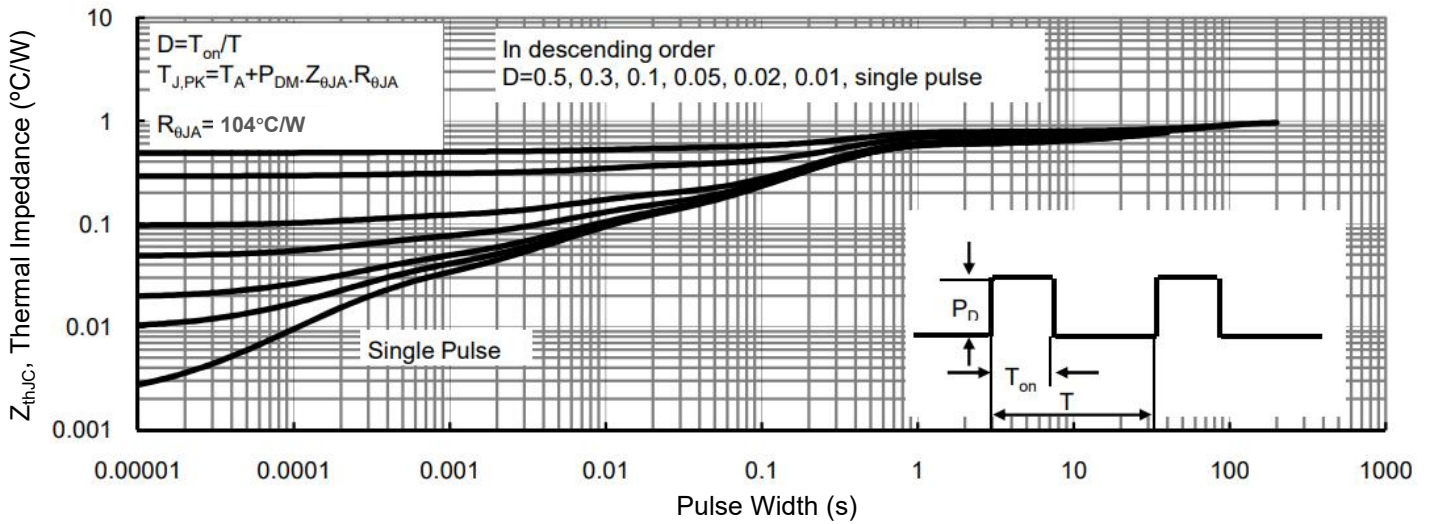
**Figure 7. Drain-Source On-Resistance**



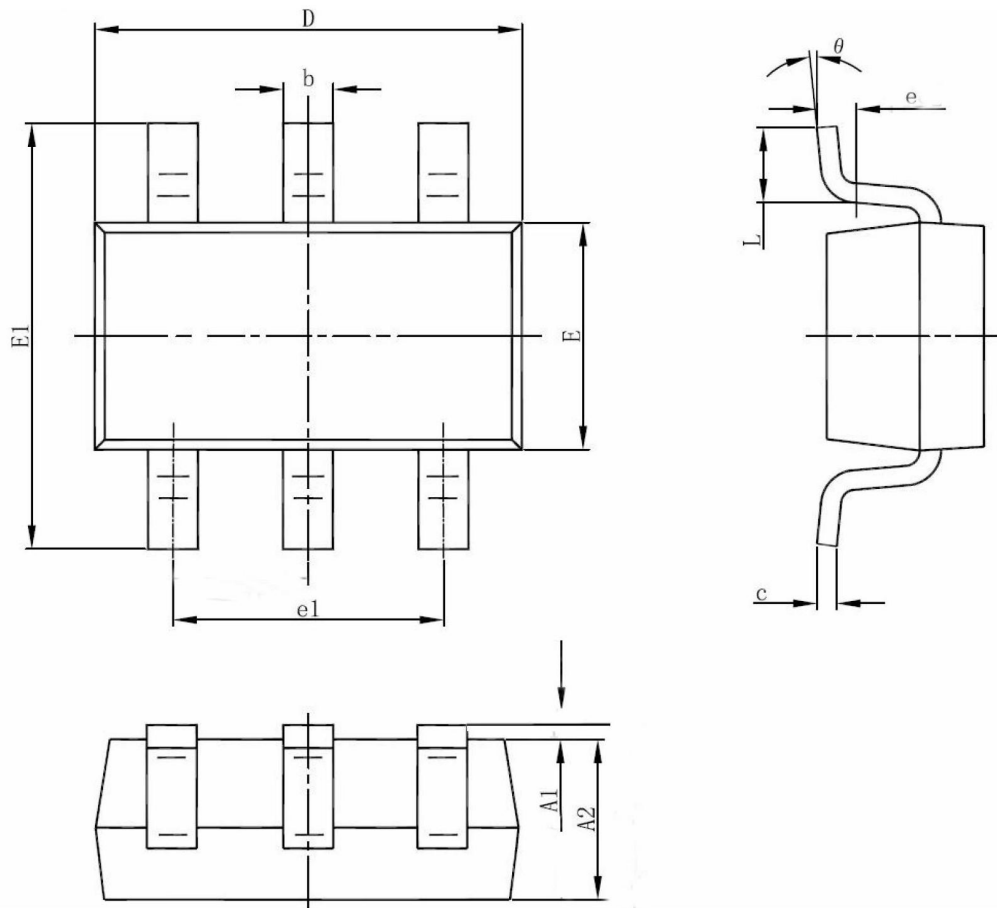
**Figure 8. Safe Operation Area**



**Figure 9. Normalized Maximum Transient Thermal Impedance**



## SOT-23-6L Package Information



DIM	MIN	NOM	MAX
A1	0.00	-	0.10
A2	1.00	1.10	1.20
b	0.30	0.40	0.50
c	0.10	0.15	0.20
D	2.80	2.90	3.00
E	1.50	1.60	1.70
E1	2.60	2.80	3.00
e	0.2GAUGE PLANE		
e1	-	1.90	-
L	0.30	0.45	0.60
$\theta$	0°	-	8°
All Dimensions in mm			