

S15C Bimodal Discrete to IO-Link Device Converter

Datasheet

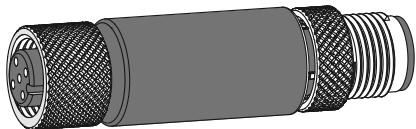

- Compact bimodal to IO-Link device converter that connects discrete inputs and sends the value to the IO-Link Master
- Enables additional logic functions such as delays, totalizer, count, EPM, duration, and mirroring
- Outputs a discrete value as received from IO-Link Master Process Data Out
- Discrete input/output can be independently configured as NPN or PNP
- Rugged over-molded design meets IP65, IP67, and IP68
- Connects directly to a sensor or anywhere in-line for ease of use
- S15C IO-Link converters are a quick, easy, and economical way to integrate non-IO-Link devices into an IO-Link system

Models

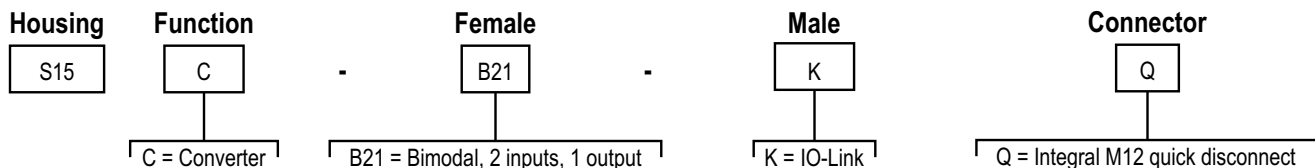

Configuration

For more information, see P/N 220757 *S15C-B21-KQ IO-Link Data Reference Guide* and P/N 220758 *S15C-B21-KQ IODD Files*.

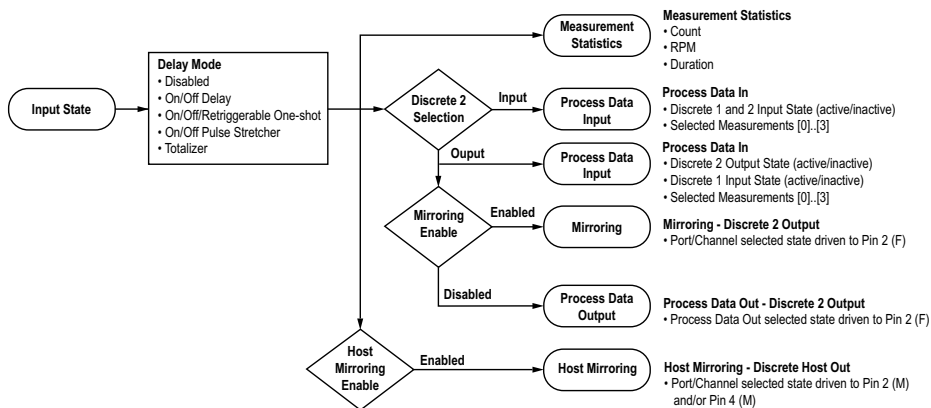

Figure 1: Logic Flow

Table 1: Measurements – Female Pins

Pin Number – Description	IO Metric	Description
Pin 4 – Discrete 1	Count Value	Running count of the received input pulses
	Duration Value	Duration of the last input pulse in μs with 50 μs granularity
	Events per Minute Value	Instantaneous rate counter in the units of events per minute Range: 1 to 300,000 Max Counter Input Frequency: 5 kHz
	Reset Metrics	<ul style="list-style-type: none"> • Do Not Reset • Reset
Pin 2 – Discrete 2	Count Value	Running count of the received input pulses
	Duration Value	Duration of the last input pulse in μs with 50 μs granularity
	Events per Minute Value	Instantaneous rate counter in the units of events per minute Range: 1 to 300,000 Max Counter Input Frequency: 5 kHz
	Reset Metrics	<ul style="list-style-type: none"> • Do Not Reset • Reset

Table 2: Pin Configuration – Female Input

Pin Number – Description	Name	Values
Pin 4 – Discrete 1	I/O Selection	<ul style="list-style-type: none"> NPN Input PNP Input
	Discrete 1 Delay Mode	<ul style="list-style-type: none"> Disabled On/Off Delay On One-shot Off One-shot On Pulse-stretcher Off Pulse-stretcher Retriggerable On One-shot Retriggerable Off One-shot Totalizer
	Discrete 1 Delay Timer 1	Discrete 1 On Delay, One-shot, Pulse-Stretcher Time, or Totalizer Count
	Discrete 1 Delay Timer 2	Discrete 1 Off Delay or Totalizer Time
Pin 2 – Discrete 2	I/O Selection	<ul style="list-style-type: none"> NPN Input PNP Input NPN Output with Pull Up PNP Output with Pull Down NPN Output with Push/Pull PNP Output with Push/Pull
	Discrete 2 Delay Mode	<ul style="list-style-type: none"> Disabled On/Off Delay On One-shot Off One-shot On Pulse-stretcher Off Pulse-stretcher Retriggerable On One-shot Retriggerable Off One-shot Totalizer
	Discrete 2 Delay Timer 1	Discrete 2 On Delay, One-shot, Pulse-stretcher Time, Or Totalizer Count
	Discrete 2 Delay Timer 2	Discrete 2 Off Delay or Totalizer Time
	Mirroring Enable	<ul style="list-style-type: none"> Disabled Enabled
	Mirroring Channel Selection	<ul style="list-style-type: none"> Pin 4 – Discrete 1 Pin 2 – Discrete 2
	Mirroring Inversion	<ul style="list-style-type: none"> Not Inverted Inverted

Table 3: Pin Configuration – Male Output

Pin Number – Description	Name	Values
Pin 2 – Discrete Host Out Pin 4 – Discrete Host Out	Host Mirroring Enable	<ul style="list-style-type: none"> Disabled Enabled
	Host Mirroring Channel Selection	<ul style="list-style-type: none"> Pin 4 – Discrete 1 Pin 2 – Discrete 2
	Host Mirroring Inversion	<ul style="list-style-type: none"> Not Inverted Inverted
	Host Mirroring Polarity	<ul style="list-style-type: none"> PNP NPN
	Host Mirroring Output Type	<ul style="list-style-type: none"> Internal Pull Up/Down (Pin 2 only) Open Collector Push/Pull

IO-Link®

IO-Link® is a point-to-point communication link between a master device and a sensor and/or light. It can be used to automatically parameterize sensors or lights and to transmit process data. For the latest IO-Link protocol and specifications, please visit www.io-link.com.

For the latest IODD files, please refer to the Banner Engineering Corp website at: www.bannerengineering.com.

Wiring Diagrams

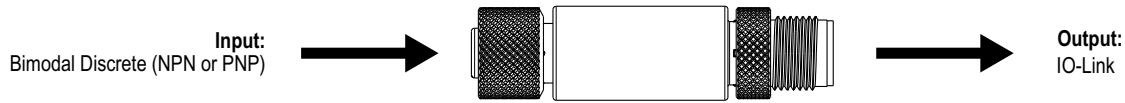

Male	Female	Pin	Wire Color
		1	Brown
		2	White
		3	Blue
		4	Black

Connecting Devices with Discrete Outputs

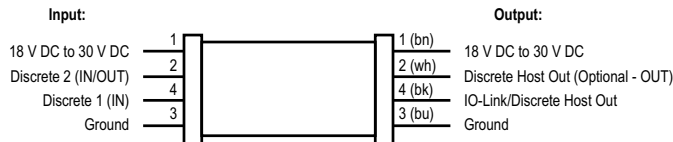

Status Indicators

Power LED Indicator (Green)

- Solid Green = Power On
- Off = Power Off

IO-Link Communication LED Indicator (Amber)

- Flashing Amber (900 ms On, 100 ms Off) = IO-Link communications are active
- Off = IO-Link communications are not present

Discrete LED Indicator (Amber)

- Solid Amber = Discrete OUT is active
- Off = Discrete OUT is inactive

Specifications

Supply Voltage

18 V DC to 30 V DC at 50 mA maximum

Power Pass-Through Current

1 A maximum

Discrete Output Load Rating

50 mA

Supply Protection Circuitry

Protected against reverse polarity and transient voltages

Leakage Current Immunity

400 μ A

Discrete Output Ratings

OFF-state leakage current:
 NPN: 300 μ A
 PNP: 10 μ A
 ON-state saturation voltage:
 NPN: 2 V at 50 mA
 PNP: 2 V at 50 mA

Indicators

Green: Power
 Amber: IO-Link communications
 Amber: Discrete OUT active

Required Overcurrent Protection

Connections

Integral male/female 4-pin M12 quick disconnect

Construction

Coupling Material: Nickel-plated brass
 Connector Body: PVC translucent black

Vibration and Mechanical Shock

Meets IEC 60068-2-6 requirements (Vibration: 10 Hz to 55 Hz, 0.5 mm amplitude, 5 minutes sweep, 30 minutes dwell)
 Meets IEC 60068-2-27 requirements (Shock: 15G 11 ms duration, half sine wave)

Environmental Rating

IP65, IP67, IP68
 NEMA/UL Type 1

Operating Conditions

Temperature: -40 °C to +70 °C (-40 °F to +158 °F)
 90% at +70 °C maximum relative humidity (non-condensing)
Storage Temperature: -40 °C to +80 °C (-40 °F to +176 °F)

WARNING: Electrical connections must be made by qualified personnel in accordance with local and national electrical codes and regulations.

Overcurrent protection is required to be provided by end product application per the supplied table.
 Overcurrent protection may be provided with external fusing or via Current Limiting, Class 2 Power Supply.
 Supply wiring leads < 24 AWG shall not be spliced.
 For additional product support, go to www.bannerengineering.com.

Supply Wiring (AWG)	Required Overcurrent Protection (A)	Supply Wiring (AWG)	Required Overcurrent Protection (A)
20	5.0	26	1.0
22	3.0	28	0.8
24	1.0	30	0.5

Certifications



Banner Engineering BV Park Lane,
 Culliganlaan 2F bus 3, 1831 Diegem,
 BELGIUM



Turck Banner LTD Blenheim House,
 Blenheim Court, Wickford, Essex
 SS11 8YT, Great Britain



FCC Part 15 Class B

This equipment has been tested and found to comply with the limits for a Class B digital device, pursuant to part 15 of the FCC Rules. These limits are designed to provide reasonable protection against harmful interference in a residential installation. This equipment generates, uses and can radiate radio frequency energy and, if not installed and used in accordance with the instructions, may cause harmful interference to radio communications. However, there is no guarantee that interference will not occur in a particular installation. If this equipment does cause harmful interference to radio or television reception, which can be determined by turning the equipment off and on, the user is encouraged to try to correct the interference by one or more of the following measures:

- Reorient or relocate the receiving antenna.
- Increase the separation between the equipment and receiver.
- Connect the equipment into an outlet on a circuit different from that to which the receiver is connected.
- Consult the dealer or an experienced radio/TV technician for help.

Industry Canada

This device complies with CAN ICES-3 (B)/NMB-3(B). Operation is subject to the following two conditions: 1) This device may not cause harmful interference; and 2) This device must accept any interference received, including interference that may cause undesired operation.

Cet appareil est conforme à la norme NMB-3(B). Le fonctionnement est soumis aux deux conditions suivantes : (1) ce dispositif ne peut pas occasionner d'interférences, et (2) il doit tolérer toute interférence, y compris celles susceptibles de provoquer un fonctionnement non souhaité du dispositif.

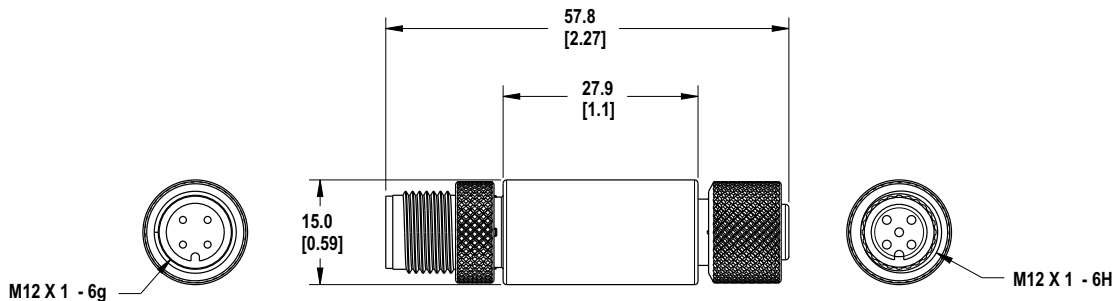

Dimensions

All measurements are listed in millimeters [inches], unless noted otherwise.

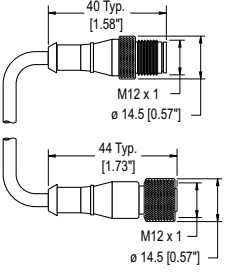

Accessories

Cordsets

4-Pin Threaded M12 Cordsets—Double Ended				
Model	Length	Style	Dimensions	Pinout
MQDEC-401SS	0.31 m (1 ft)	Male Straight/Female Straight		Female
MQDEC-403SS	0.91 m (2.99 ft)			
MQDEC-406SS	1.83 m (6 ft)			
MQDEC-412SS	3.66 m (12 ft)			<p>1 = Brown 2 = White 3 = Blue 4 = Black</p>
MQDEC-420SS	6.10 m (20 ft)			
MQDEC-430SS	9.14 m (30.2 ft)			
MQDEC-450SS	15.2 m (49.9 ft)			

Banner Engineering Corp Limited Warranty

Banner Engineering Corp. warrants its products to be free from defects in material and workmanship for one year following the date of shipment. Banner Engineering Corp. will repair or replace, free of charge, any product of its manufacture which, at the time it is returned to the factory, is found to have been defective during the warranty period. This warranty does not cover damage or liability for misuse, abuse, or the improper application or installation of the Banner product.

THIS LIMITED WARRANTY IS EXCLUSIVE AND IN LIEU OF ALL OTHER WARRANTIES WHETHER EXPRESS OR IMPLIED (INCLUDING, WITHOUT LIMITATION, ANY WARRANTY OF MERCHANTABILITY OR FITNESS FOR A PARTICULAR PURPOSE), AND WHETHER ARISING UNDER COURSE OF PERFORMANCE, COURSE OF DEALING OR TRADE USAGE.

This Warranty is exclusive and limited to repair or, at the discretion of Banner Engineering Corp., replacement. **IN NO EVENT SHALL BANNER ENGINEERING CORP. BE LIABLE TO BUYER OR ANY OTHER PERSON OR ENTITY FOR ANY EXTRA COSTS, EXPENSES, LOSSES, LOSS OF PROFITS, OR ANY INCIDENTAL, CONSEQUENTIAL OR SPECIAL DAMAGES RESULTING FROM ANY PRODUCT DEFECT OR FROM THE USE OR INABILITY TO USE THE PRODUCT, WHETHER ARISING IN CONTRACT OR WARRANTY, STATUTE, TORT, STRICT LIABILITY, NEGLIGENCE, OR OTHERWISE.**

Banner Engineering Corp. reserves the right to change, modify or improve the design of the product without assuming any obligations or liabilities relating to any product previously manufactured by Banner Engineering Corp. Any misuse, abuse, or improper application or installation of this product or use of the product for personal protection applications when the product is identified as not intended for such purposes will void the product warranty. Any modifications to this product without prior express approval by Banner Engineering Corp will void the product warranties. All specifications published in this document are subject to change; Banner reserves the right to modify product specifications or update documentation at any time. Specifications and product information in English supersede that which is provided in any other language. For the most recent version of any documentation, refer to: www.bannerengineering.com.

For patent information, see www.bannerengineering.com/patents.

Document title: S15C Bimodal Discrete to IO-Link Device Converter - Datasheet
 Part number: 220754
 Revision: D
 Original Instructions
 © Banner Engineering Corp. All rights reserved.

