

# Bridgelux ES Rectangle Array Series

## Product Data Sheet DS24

**BXRA-xxx0800, BXRA-xxx1200, BXRA-xxx2000, BXRA-40Exxxx,  
BXRA-5xC1100, BXRA-5xC1600, BXRA-5xC2600**

### Introduction

The Bridgelux family of LED Array products delivers high performance, compact and cost-effective solid-state lighting solutions to serve the general lighting market. These products combine the higher efficacy, lifetime, and reliability benefits of LEDs with the light output levels of many conventional lighting sources. The Bridgelux ES Array Series enables lamp and luminaire designs surpassing efficacy and quality of light requirements driven by regulatory standards with reasonable system design margins, enabling lighting product compliance to Energy Star, DLC, Title 24, Part L and other global standards.

The Bridgelux ES Array products are a high performance alternative to conventional solid state solutions, delivering between 700 and 3000 lumens under application conditions in warm, neutral and cool white color temperatures. These compact high flux density light sources deliver uniform high quality illumination without pixilation or the multiple shadow effect caused by LED component based solutions. To simplify system design for appropriate light output, Bridgelux LED Arrays are specified to deliver performance under typical use conditions.

These integrated plug and play solutions reduce system complexity and enable miniaturized cost-effective lamp and luminaire designs. Lighting system designs incorporating these LED Arrays deliver comparable performance to that of 60-200 Watt incandescent and halogen, 7-42 Watt compact fluorescent, and 18-50 Watt HID based luminaires and feature increased system level efficacy and service life. Typical applications include replacement lamps, task, accent, spot, retail, track, down light, low bay, wide area, security, wall pack and street lighting.

### Features

- Compact high flux density light source
- Uniform high quality illumination
- Minimum 70, 80 and 90 CRI options
- Streamlined thermal path
- Energy Star / ANSI compliant color binning structure with 3SDCM options
- More energy efficient than incandescent, halogen and fluorescent lamps
- Low voltage DC operation
- Instant light with unlimited dimming
- 5-Year warranty
- RoHS compliant and Pb free

### Benefits

- Enhanced optical control
- Clean white light without pixilation
- High quality true color reproduction
- Significantly reduced thermal resistance and increased operating temperatures
- Uniform consistent white light
- Lower operating costs
- Increased safety
- Easy to use with daylight and motion detectors to enable increased energy savings
- Reduced maintenance costs
- Environmentally friendly, no disposal issue



---

Table of Contents	Page
Product Nomenclature	3
Average Lumen Maintenance Characteristics	3
IES LM-80 Test Data	3
Environmental Compliance	4
UL Recognition	4
Minor Product Change Policy	4
Cautionary Statements	4
Case Temperature Measurement Point	5
Selection Guide	6
The following configurations are available:	6
Flux Characteristics	6
Optical Characteristics	9
Electrical Characteristics	10
Absolute Minimum and Maximum Ratings	11
Absolute Minimum and Maximum Ratings (continued)	12
Typical Performance at Alternative Drive Currents	13
Typical Performance at Alternative Drive Currents (continued)	14
Mechanical Dimensions	15
Typical Radiation Pattern	16
Wavelength Characteristics at Rated Test Current, $T_j=25^{\circ}\text{C}$	17
Typical Light Output Characteristics vs. Temperature	19
Typical Chromaticity Characteristics vs. Temperature	20
Forward Current Characteristics	21
Forward Current Characteristics (continued)	22
Color Binning Information	23
Design Resources	26

---

## Product Nomenclature

The part number designation for Bridgelux LED Arrays is explained as follows:

BXRA – AB C DEFG – H – IJ - KLM

Where:

BXRA – Designates product family

AB – Designates the nominal ANSI color temperature; 27 = 2700K; 30 = 3000K, etc.

C - Designates minimum CRI; C = 70, E = 80, G = 90

DEFG - Designates Nominal Flux; 0800 = 800lm, 1200 = 1200lm, 2000 = 2000lm, etc.

H – Designates array configuration

IJ – Designates CCT Bin options

3000K as an example:

00 = Full ANSI: Q3, Q4, R3, R4

03 = 3 SDCM

KLM – Designates wire option

## Average Lumen Maintenance Characteristics

Bridgelux projects that its family of LED Array products will deliver, on average, greater than 70% lumen maintenance after 50,000 hours of operation at the rated forward test current. This performance assumes constant current operation with case temperature maintained at or below 85°C. For use beyond these typical operating conditions please consult your Bridgelux sales representative for further assistance.

These projections are based on a combination of package test data, semiconductor chip reliability data, a fundamental understanding of package related degradation mechanisms, and performance observed from products installed in the field using Bridgelux die technology. Bridgelux conducts lumen maintenance tests per LM80. Observation of design limits is required in order to achieve this projected lumen maintenance.

## IES LM-80 Test Data

Bridgelux has carried out extensive testing on multiple LED arrays according to the IES LM-80 test protocols. LM80 data is available to support all BXRA LED array products.

The IES LM-80 qualification test method is required for an LED light source. The LM-80 test method does not apply to an LED luminaire light fixture. LM-80 is a rigorous test procedure that has been designed to provide LED light source test data to support an ENERGY STAR rating for a luminaire light fixture.

When a manufacturer requires an ENERGY STAR rating for a fixture, the manufacture must have the luminaire light fixture tested to LM-79 by an accredited test facility. This test ensures that the fixture meets the photometric performance required for the ENERGY STAR rating under the specified operating conditions of the fixture.

The fixture manufacturer must provide an LM-80 report with the appropriate test data to support the operating conditions of the fixture that is to be submitted. Bridgelux can supply an LM-80 report for specific requests, contact your local Bridgelux sales representative.

---

## Environmental Compliance

Bridgelux is committed to providing environmentally friendly products to the solid-state lighting market. Bridgelux LED Arrays comply with the European Union directives on the restriction of hazardous substances in electronic equipment, namely the RoHS directive. Bridgelux does not intentionally add the following restricted materials to LED Array products: lead, mercury, cadmium, hexavalent chromium, polybrominated biphenyls (PBB) or polybrominated diphenyl ethers (PBDE).

## UL Recognition

Bridgelux secures UL Recognition for all the LED Array products. Please refer to the UL file E333389 for the latest list of UL Recognized Arrays. Bridgelux uses UL Recognized materials with suitable flammability ratings in the LED Array to streamline the process for customers to secure UL listing of the final luminaire product. Bridgelux recommends that luminaires are designed with a Class 2 Driver to facilitate the UL listing process.

## Minor Product Change Policy

The rigorous qualification testing on products offered by Bridgelux provides performance assurance. Slight cosmetic changes that do not affect form, fit, or function may occur as Bridgelux continues product optimization.

## Cautionary Statements

### CAUTION: CONTACT WITH OPTICAL AREA

Avoid any contact with the optical area. Do not touch the optical area of the LED Array or apply stress to the yellow phosphor resin area – it could damage to the LED Array.

Optics and reflectors must not be mounted in contact with the yellow phosphor resin area or the white ring that surrounds the yellow phosphor area. Using the white ring to secure optics can result in damage to the LED Array as the ring is not designed to act as a mechanical locating feature. Optical devices may be mounted on the top surface of the LED Array substrate outside of the white ring maximum OD as specified in the product data sheet. Use the mechanical features of the LED Array substrate edges and/or mounting holes to locate and secure the optical device as needed.

### CAUTION: EYE SAFETY

Eye safety classification for the use of Bridgelux LED Arrays is in accordance with IEC specification EN62471: Photobiological Safety of Lamps and Lamp Systems. Bridgelux LED Arrays are classified as Risk Group 1 (Low Risk) when operated at or below their rated test current. Please use appropriate precautions. It is important that employees working with LEDs are trained to use them safely.

### CAUTION: RISK OF BURN

Do not touch the LED Array or resin area during operation. Allow the LED Array to cool for a sufficient period of time before handling. The LED Array may reach elevated temperatures such that it can burn skin when touched.

---

## CAUTION: CHEMICAL EXPOSURE HAZARD

Exposure to some chemicals commonly used in luminaire manufacturing and assembly can cause damage to the LED Array. Please consult Application Note AN11 for additional information.

### Case Temperature Measurement Point

A case temperature measurement point location is included on the top surface of the Bridgelux LED Arrays. The location of this measurement point is indicated in the mechanical dimensions section of this data sheet.

The purpose of this measurement point is to allow the user access to a measurement point closely linked to the true case temperature on the back surface of the LED Array. Once the LED Array is installed, it is challenging to measure the back surface of the array, or true case temperature. Measuring the top surface of the product can lead to inaccurate results due to the poor thermal conductivity of the top layers of the array such as the solder mask and other materials.

Bridgelux has provided the case temperature measurement location in a manner which closely ties it to the true case temperature of the LED Array under steady state operation. Deviations between thermal measurements taken at the point indicated and the back of the LED Array differ by less than 1 °C, providing a robust method to testing thermal operation once the product is installed.

## Selection Guide

The following configurations are available

Table 1: Selection Guide for ES Rectangular Arrays

<b>BXRA Part Number<sup>[1]</sup></b>	<b>CCT</b> (Nominal)	<b>CRI</b> (min)	<b>Typical DC Flux</b> <b>T<sub>case</sub>=70°C</b> (lm)	<b>Typical Pulsed Flux</b> <b>T<sub>j</sub>=25°C</b> (lm)	<b>Test Current</b> (mA)	<b>V<sub>f</sub></b> (Typ) (V)	<b>Power</b> (Typ) (W)	<b>Efficacy</b> (Typ at T <sub>j</sub> 25°C) (lm/W)
BXRA-27E0800-B-00	2700	80	855	950	500	20.7	10.4	92
BXRA-27G0800-B-00	2700	90	730	810	500	20.7	10.4	78
BXRA-27E1200-B-00	2700	80	1260	1400	500	29.6	14.8	95
BXRA-27G1200-B-00	2700	90	1070	1190	500	29.6	14.8	80
BXRA-27E2000-B-00	2700	80	2010	2260	700	37.0	25.9	87
BXRA-27G2000-B-00	2700	90	1750	1975	700	37.0	25.9	76
BXRA-30E0800-B-00	3000	80	900	1010	500	20.7	10.4	98
BXRA-30G0800-B-00	3000	90	800	890	500	20.7	10.4	86
BXRA-30E1200-B-00	3000	80	1320	1475	500	29.6	14.8	100
BXRA-30G1200-B-00	3000	90	1170	1300	500	29.6	14.8	88
BXRA-30E2000-B-00	3000	80	2130	2400	700	37.0	25.9	93
BXRA-30G2000-B-00	3000	90	1780	2000	700	37.0	25.9	77
BXRA-35E0800-B-00	3500	80	980	1095	500	20.7	10.4	106
BXRA-35E1200-B-00	3500	80	1430	1595	500	29.6	14.8	108
BXRA-35E2000-B-00	3500	80	2270	2550	700	37.0	25.9	98
BXRA-40E0950-B-00	4000	80	1030	1150	500	20.7	10.4	111
BXRA-40E1350-B-00	4000	80	1520	1690	500	29.6	14.8	114
BXRA-40E2200-B-00	4000	80	2450	2750	700	37.0	25.9	106
BXRA-50C1100-B-00	5000	70	1180	1320	500	20.7	10.4	128
BXRA-50C1600-B-00	5000	70	1725	1920	500	29.6	14.8	130
BXRA-50C2600-B-00	5000	70	2760	3100	700	37.0	25.9	120
BXRA-56C1100-B-00	5600	70	1180	1320	500	20.7	10.4	128
BXRA-56C1600-B-00	5600	70	1725	1920	500	29.6	14.8	130
BXRA-56C2600-B-00	5600	70	2760	3100	700	37.0	25.9	120

<sup>1</sup>3SDCM (3-step) color control available on certain configurations

## Color Control Options

ES LED Series Arrays are available in the following color control options.

Table 2: Color Control Options

Product	CCT	CRI	7SDCM Part Number	3SDCM Part Number
ES LED Array	2700K	80	BXRA-27E0800-B-00	BXRA-27E0800-B-03
ES LED Array	2700K	90	BXRA-27G0800-B-00	BXRA-27G0800-B-03
ES LED Array	2700K	80	BXRA-27E1200-B-00	BXRA-27E1200-B-03
ES LED Array	2700K	90	BXRA-27G1200-B-00	BXRA-27G1200-B-03
ES LED Array	2700K	80	BXRA-27E2000-B-00	BXRA-27E2000-B-03
ES LED Array	2700K	90	BXRA-27G2000-B-00	BXRA-27G2000-B-03
ES LED Array	3000K	80	BXRA-30E0800-B-00	BXRA-30E0800-B-03
ES LED Array	3000K	90	BXRA-30G0800-B-00	BXRA-30G0800-B-03
ES LED Array	3000K	80	BXRA-30E1200-B-00	BXRA-30E1200-B-03
ES LED Array	3000K	90	BXRA-30G1200-B-00	BXRA-30G1200-B-03
ES LED Array	3000K	80	BXRA-30E2000-B-00	BXRA-30E2000-B-03
ES LED Array	3000K	90	BXRA-30G2000-B-00	BXRA-30G2000-B-03
ES LED Array	3500K	80	BXRA-35E0800-B-00	BXRA-35E0800-B-03
ES LED Array	3500K	80	BXRA-35E1200-B-00	BXRA-35E1200-B-03
ES LED Array	3500K	80	BXRA-35E2000-B-00	BXRA-35E2000-B-03
ES LED Array	4000K	80	BXRA-40E0950-B-00	BXRA-40E0950-B-03
ES LED Array	4000K	80	BXRA-40E1350-B-00	BXRA-40E1350-B-03
ES LED Array	4000K	80	BXRA-40E2200-B-00	BXRA-40E2200-B-03
ES LED Array	5000K	70	BXRA-50C1100-B-00	Not Available
ES LED Array	5000K	70	BXRA-50C1600-B-00	Not Available
ES LED Array	5000K	70	BXRA-50C2600-B-00	Not Available
ES LED Array	5600K	70	BXRA-56C1100-B-00	Not Available
ES LED Array	5600K	70	BXRA-56C1600-B-00	Not Available
ES LED Array	5600K	70	BXRA-56C2600-B-00	Not Available

PRELIMINARY

## Flux Characteristics

Table 3: Flux Characteristics

Color	ANSI CCT (K)	BXRA Part Number	CRI (min) <sup>[4]</sup>	Typical DC Flux T <sub>case</sub> =70°C (lm) <sup>[1,3]</sup>	Minimum Pulsed Flux T <sub>j</sub> =25°C (lm) <sup>[1,2]</sup>	Typical Pulsed Flux T <sub>j</sub> =25°C (lm) <sup>[1,2]</sup>	Test Current (mA) <sup>[2]</sup>
Warm White	2700	BXRA-27E0800-B-00	80	855	850	950	500
		BXRA-27G0800-B-00	90	730	720	810	500
		BXRA-27E1200-B-00	80	1260	1200	1400	500
		BXRA-27G1200-B-00	90	1070	1020	1190	500
		BXRA-27E2000-B-00	80	2010	1980	2260	700
		BXRA-27G2000-B-00	90	1750	1730	1975	700
	3000	BXRA-30E0800-B-00	80	900	900	1010	500
		BXRA-30G0800-B-00	90	800	790	890	500
		BXRA-30E1200-B-00	80	1320	1270	1475	500
		BXRA-30G1200-B-00	90	1170	1120	1300	500
		BXRA-30E2000-B-00	80	2130	2110	2400	700
		BXRA-30G2000-B-00	90	1780	1850	2000	700
	3500	BXRA-35E0800-B-00	80	980	970	1095	500
		BXRA-35E1200-B-00	80	1430	1370	1595	500
		BXRA-35E2000-B-00	80	2270	2280	2550	700
Neutral White	4000	BXRA-40E0950-B-00	80	1030	1030	1150	500
		BXRA-40E1350-B-00	80	1520	1450	1690	500
		BXRA-40E2200-B-00	80	2450	2400	2750	700
Cool White	5000	BXRA-50C1100-B-00	70	1180	1170	1320	500
		BXRA-50C1600-B-00	70	1725	1650	1920	500
		BXRA-50C2600-B-00	70	2760	2740	3100	700
	5600	BXRA-56C1100-B-00	70	1180	1170	1320	500
		BXRA-56C1600-B-00	70	1725	1650	1920	500
		BXRA-56C2600-B-00	70	2760	2740	3100	700

Notes for Table 3:

1. Bridgelux maintains a  $\pm 7\%$  tolerance of flux measurements.
2. Parts are tested in pulsed conditions,  $T_j = 25^\circ\text{C}$ . Pulse width is 10 ms at rated test current.
3. Typical performance when driven at DC (direct current) test current with LED Array case temperature maintained at  $70^\circ\text{C}$ , mounted to heat sink with thermal interface material. Please contact a Bridgelux sales representative for additional details.
4. Typical R9 value for 90 CRI product options is 50.
5. Reference Table 8 and 9 for typical performance at other driver currents (including those commonly available in the market).



## Optical Characteristics

Table 4: Optical Characteristics

Color	ANSI CCT (K)	BXRA Part Number	Color Temperature (CCT) <sup>[1], [2], [3]</sup>			Minimum Color Rendering Index	Typical Viewing Angle (Degrees) $2\theta^{1/2}$ <sup>[4]</sup>	Typical Center Beam Candle Power (cd) <sup>[5]</sup>
			Min	Typ	Max			
Warm White	2700	BXRA-27E0800-B-00	2580 K	2725 K	2870 K	80	120	300
		BXRA-27G0800-B-00	2580 K	2725 K	2870 K	90	120	255
		BXRA-27E1200-B-00	2580 K	2725 K	2870 K	80	120	445
		BXRA-27G1200-B-00	2580 K	2725 K	2870 K	90	120	380
		BXRA-27E2000-B-00	2580 K	2725 K	2870 K	80	120	720
		BXRA-27G2000-B-00	2580 K	2725 K	2870 K	90	120	625
	3000	BXRA-30E0800-B-00	2870 K	3045 K	3220 K	80	120	320
		BXRA-30G0800-B-00	2870 K	3045 K	3220 K	90	120	280
		BXRA-30E1200-B-00	2870 K	3045 K	3220 K	80	120	470
		BXRA-30G1200-B-00	2870 K	3045 K	3220 K	90	120	410
		BXRA-30E2000-B-00	2870 K	3045 K	3220 K	80	120	760
		BXRA-30G2000-B-00	2870 K	3045 K	3220 K	90	120	630
3500	BXRA-35E0800-B-00	3220 K	3465 K	3710 K	80	120	350	
	BXRA-35E1200-B-00	3220 K	3465 K	3710 K	80	120	500	
	BXRA-35E2000-B-00	3220 K	3465 K	3710 K	80	120	810	
Neutral White	4000	BXRA-40E0950-B-00	3700 K	4000 K	4250 K	80	120	360
		BXRA-40E1350-B-00	3700 K	4000 K	4250 K	80	120	535
		BXRA-40E2200-B-00	3700 K	4000 K	4250 K	80	120	875
Cool White	5000	BXRA-50C1100-B-00	5028 K	5100 K	5665 K	70	120	420
		BXRA-50C1600-B-00	5028 K	5100 K	5665 K	70	120	610
		BXRA-50C2600-B-00	5028 K	5100 K	5665 K	70	120	985
	5600	BXRA-56C1100-B-00	5310 K	5665 K	6020 K	70	120	420
		BXRA-56C1600-B-00	5310 K	5665 K	6020 K	70	120	610
		BXRA-56C2600-B-00	5310 K	5665 K	6020 K	70	120	985

Notes for Table 4:

1. Parts are tested in pulsed conditions,  $T_j = 25^\circ\text{C}$ . Pulse width is 10 ms at rated test current.
2. Refer to Flux Characteristic Table for test current data.
3. Product is binned for color in x y coordinates.
4. Viewing angle is the off axis angle from the centerline where  $I_v$  is  $\frac{1}{2}$  of the peak value.
5. Center beam candle power is a calculated value based on lambertian radiation pattern at nominal test current.

## Electrical Characteristics

Table 5: Electrical Characteristics

Color	Base Part Number <sup>[1]</sup>	Forward Voltage Vf (V) <sup>[2]</sup>			Test Current (mA) <sup>[1]</sup>	Power	Typical Coefficient of Forward Voltage (mV/°C) $\Delta V_f/\Delta T_j$	Typical Thermal Resistance Junction to Case (°C/W) $R_{\theta_j-c}$
		Min	Typ	Max				
Warm White	BXRA-27E0800-B-00	18.6	20.7	22.8	500	10.4	-7 to -21	0.95
	BXRA-27G0800-B-00	18.6	20.7	22.8	500	10.4	-7 to -21	0.95
	BXRA-27E1200-B-00	26.6	29.6	32.6	500	14.8	-10 to -30	0.80
	BXRA-27G1200-B-00	26.6	29.6	32.6	500	14.8	-10 to -30	0.80
	BXRA-27E2000-B-00	33.3	37.0	40.7	700	25.9	-12 to -36	0.65
	BXRA-27G2000-B-00	33.3	37.0	40.7	700	25.9	-12 to -36	0.65
	BXRA-30E0800-B-00	18.6	20.7	22.8	500	10.4	-7 to -21	0.95
	BXRA-30G0800-B-00	18.6	20.7	22.8	500	10.4	-7 to -21	0.95
	BXRA-30E1200-B-00	26.6	29.6	32.6	500	14.8	-10 to -30	0.80
	BXRA-30G1200-B-00	26.6	29.6	32.6	500	14.8	-10 to -30	0.80
	BXRA-30E2000-B-00	33.3	37.0	40.7	700	25.9	-12 to -36	0.65
	BXRA-30G2000-B-00	33.3	37.0	40.7	700	25.9	-12 to -36	0.65
	BXRA-35E0800-B-00	18.6	20.7	22.8	500	10.4	-7 to -21	0.95
	BXRA-35E1200-B-00	26.6	29.6	32.6	500	14.8	-10 to -30	0.80
BXRA-35E2000-B-00	33.3	37.0	40.7	700	25.9	-12 to -36	0.65	
Neutral White	BXRA-40E0950-B-00	18.6	20.7	22.8	500	10.4	-7 to -21	0.95
	BXRA-40E1350-B-00	26.6	29.6	32.6	500	14.8	-10 to -30	0.80
	BXRA-40E2200-B-00	33.3	37.0	40.7	700	25.9	-12 to -36	0.65
Cool White	BXRA-50C1100-B-00	18.6	20.7	22.8	500	10.4	-7 to -21	0.95
	BXRA-50C1600-B-00	26.6	29.6	32.6	500	14.8	-10 to -30	0.80
	BXRA-50C2600-B-00	33.3	37.0	40.7	700	25.9	-12 to -36	0.65
	BXRA-56C1100-B-00	18.6	20.7	22.8	500	10.4	-7 to -21	0.95
	BXRA-56C1600-B-00	26.6	29.6	32.6	500	14.8	-10 to -30	0.80
	BXRA-56C2600-B-00	33.3	37.0	40.7	700	25.9	-12 to -36	0.65

Notes for Table 5:

1. Parts are tested in pulsed conditions,  $T_j = 25^\circ\text{C}$ . Pulse width is 10 ms at rated test current.
2. Bridgelux maintains a tester tolerance of  $\pm 0.10$  V on forward voltage measurements.

## Absolute Minimum and Maximum Ratings

Table 6: Maximum Current and Reverse Voltage Ratings

Color	Base Part Number	Maximum DC Forward Current (mA)	Maximum Peak Pulsed Current (mA) <sup>[1]</sup>	Maximum Reverse Voltage (Vr) <sup>[2]</sup>
Warm White	BXRA-27E0800-B-00	750	1000	-35
	BXRA-27G0800-B-00	750	1000	-35
	BXRA-27E1200-B-00	750	1000	-50
	BXRA-27G1200-B-00	750	1000	-50
	BXRA-27E2000-B-00	750	1000	-60
	BXRA-27G2000-B-00	750	1000	-60
	BXRA-30E0800-B-00	750	1000	-35
	BXRA-30G0800-B-00	750	1000	-35
	BXRA-30E1200-B-00	750	1000	-50
	BXRA-30G1200-B-00	750	1000	-50
	BXRA-30E2000-B-00	750	1000	-60
	BXRA-30G2000-B-00	750	1000	-60
	BXRA-35E0800-B-00	750	1000	-35
	BXRA-35E1200-B-00	750	1000	-50
	BXRA-35E2000-B-00	750	1000	-60
Neutral White	BXRA-40E0950-B-00	750	1000	-35
	BXRA-40E1350-B-00	750	1000	-50
	BXRA-40E2200-B-00	750	1000	-60
Cool White	BXRA-50C1100-B-00	750	1000	-35
	BXRA-50C1600-B-00	750	1000	-50
	BXRA-50C2600-B-00	750	1000	-60
	BXRA-56C1100-B-00	750	1000	-35
	BXRA-56C1600-B-00	750	1000	-50
	BXRA-56C2600-B-00	750	1000	-60

Notes for Table 6:

1. Bridgelux recommends a maximum duty cycle of 10% when operating LED Arrays at the maximum peak pulsed current specified.
2. Light emitting diodes are not designed to be driven in reverse voltage.

---

Absolute Minimum and Maximum Ratings (continued)

Table 7: Maximum Ratings

<b>Parameter</b>	<b>Maximum Rating</b>
LED Junction Temperature	150 °C
Storage Temperature	-40 °C to +105 °C
Operating Case Temperature	105 °C
Soldering Temperature*	350 °C or lower for a maximum of 3.5 seconds

\*See Bridgelux Application Note AN15: Reflow Soldering of Bridgelux LED Arrays for solder procedure ([www.Bridgelux.com](http://www.Bridgelux.com))

## Typical Performance at Alternative Drive Currents

Bridgelux LED Arrays are tested to the specifications shown in Tables 3, 4 and 5. Arrays may also be driven at alternative drive currents dependent on the specific application. Typical performance at any drive current can be derived from the flux vs. current characteristics shown in Figures 5 and 6 and from the current vs. voltage characteristics shown in Figures 10, 11 and 12. Typical performance at common drive currents is summarized in Tables 8 and 9.

Table 8: Typical Product Performance at Alternative Drive Currents

Color	ANSI CCT (K)	BXRA Part Number	CRI	Typical DC Luminous Flux $\Phi_v$ (lm) $T_{case} = 70^\circ C$	Typical Pulsed Luminous Flux $\Phi_v$ (lm) $T_j = 25^\circ C$	Typical Forward Voltage $V_f$ (V)	Forward Current (mA) <sup>[2]</sup>
Warm White	2700	BXRA-27E0800-B-00	80	620	680	20.0	350
				<b>865</b>	<b>950</b>	<b>20.7</b>	<b>500</b>
		BXRA-27G0800-B-00	90	525	580	20.0	350
				<b>735</b>	<b>810</b>	<b>20.7</b>	<b>500</b>
		BXRA-27E1200-B-00	80	960	1055	28.6	350
				<b>1260</b>	<b>1400</b>	<b>29.6</b>	<b>500</b>
	BXRA-27G1200-B-00	90	775	850	28.6	350	
			<b>1070</b>	<b>1190</b>	<b>29.6</b>	<b>500</b>	
	BXRA-27E2000-B-00	80	1085	1195	34.3	350	
			1500	1665	35.5	500	
			<b>1990</b>	<b>2260</b>	<b>37.0</b>	<b>700</b>	
	BXRA-27G2000-B-00	90	950	1045	34.3	350	
			1310	1455	35.5	500	
			<b>1735</b>	<b>1975</b>	<b>37.0</b>	<b>700</b>	
	3000	BXRA-30E0800-B-00	80	655	720	20.0	350
				<b>920</b>	<b>1010</b>	<b>20.7</b>	<b>500</b>
		BXRA-30G0800-B-00	90	580	640	20.0	350
				<b>810</b>	<b>890</b>	<b>20.7</b>	<b>500</b>
BXRA-30E1200-B-00		80	965	1060	28.6	350	
			<b>1325</b>	<b>1475</b>	<b>29.6</b>	<b>500</b>	
BXRA-30G1200-B-00	90	845	930	28.6	350		
		<b>1170</b>	<b>1300</b>	<b>29.6</b>	<b>500</b>		
BXRA-30E2000-B-00	80	1155	1270	34.3	350		
		1590	1770	35.5	500		
		<b>2110</b>	<b>2400</b>	<b>37.0</b>	<b>700</b>		
BXRA-30G2000-B-00	90	950	1050	34.3	350		
		1325	1475	35.5	500		
		<b>1750</b>	<b>2000</b>	<b>37.0</b>	<b>700</b>		

Typical Performance at Alternative Drive Currents (continued)

Table 9: Typical Product Performance at Alternative Drive Currents

Color	ANSI CCT (K)	BXRA Part Number	CRI	Typical DC Luminous Flux $\Phi_v$ (lm) $T_{case} = 70^\circ C$	Typical Pulsed Luminous Flux $\Phi_v$ (lm) $T_j = 25^\circ C$	Typical Forward Voltage $V_f$ (V)	Forward Current (mA) <sup>(2)</sup>
Warm White	3500	BXRA-35E0800-B-00	80	750	825	20.0	350
				<b>995</b>	<b>1095</b>	<b>20.7</b>	<b>500</b>
		BXRA-35E1200-B-00	80	1040	1145	28.6	350
				<b>1435</b>	<b>1595</b>	<b>29.6</b>	<b>500</b>
		BXRA-35E2000-B-00	80	1225	1350	34.8	350
				<b>2225</b>	<b>2550</b>	<b>37.0</b>	<b>700</b>
Neutral White	4000	BXRA-40E0950-B-00	80	785	865	20.7	350
				<b>1045</b>	<b>1150</b>	<b>20.7</b>	<b>500</b>
		BXRA-40E1350-B-00	80	1100	1210	28.6	350
				<b>1520</b>	<b>1690</b>	<b>29.6</b>	<b>500</b>
		BXRA-40E2200-B-00	80	1320	1450	34.3	350
				<b>2420</b>	<b>2750</b>	<b>37.0</b>	<b>700</b>
Cool White	5000	BXRA-50C1100-B-00	70	860	945	20.0	350
				<b>1200</b>	<b>1320</b>	<b>20.7</b>	<b>500</b>
		BXRA-50C1600-B-00	70	1275	1400	28.6	350
				<b>1725</b>	<b>1920</b>	<b>29.6</b>	<b>500</b>
		BXRA-50C2600-B-00	70	1475	1625	34.3	350
				<b>2725</b>	<b>3100</b>	<b>37.0</b>	<b>700</b>
	5600	BXRA-56C1100-B-00	70	860	945	20.0	350
				<b>1200</b>	<b>1320</b>	<b>20.7</b>	<b>500</b>
		BXRA-56C1600-B-00	70	1275	1400	28.6	350
				<b>1725</b>	<b>1920</b>	<b>29.6</b>	<b>500</b>
		BXRA-56C2600-B-00	70	1475	1625	34.3	350
				<b>2725</b>	<b>3100</b>	<b>37.0</b>	<b>700</b>

Notes for Table 8 and 9:

1. Product is tested and binned at the specified drive current.
2. Operating these LED Arrays at or below the drive currents listed in Tables 8 and 9, with a case temperature maintained at or below 70°C, will enable the average lumen maintenance projection outlined earlier in this Product Data Sheet.

## Mechanical Dimensions

Figure 1: Drawing for ES Rectangular Arrays

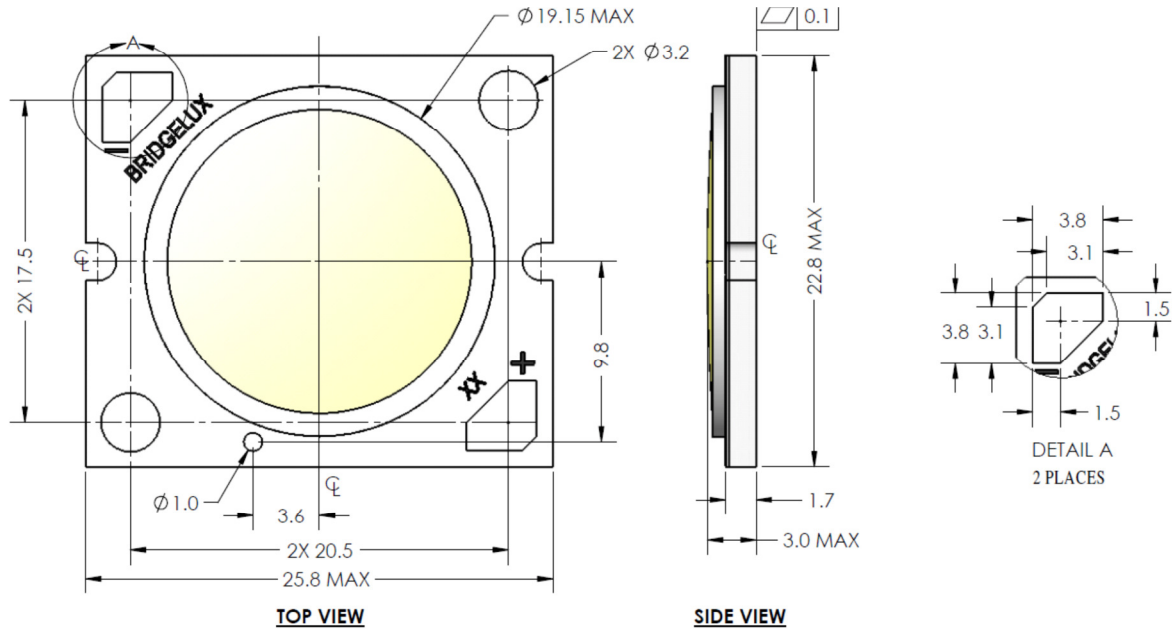

### Notes for Figure 1:

1. Mounting holes are for M2.5 or #4 screws.
2. Solder pads are labeled "+" and "-" to denote positive and negative, respectively.
3. Drawings are not to scale.
4. Drawing dimensions are in millimeters.
5. Bridgelux recommends two tapped holes for mounting screws with  $26.92 \pm 0.10$ mm center-to-center spacing.
6. Unless otherwise specified, tolerances are  $\pm 0.10$ mm.
7. Refer to product Application Notes AN10 and AN11 for product handling, mounting and heat sink recommendations.
8. The optical center of the LED Array is defined by the mechanical center of the array.
9. Bridgelux maintains a flatness of 0.1 mm across the mounting surface of the array. Refer to Application Notes AN10 and AN11 for product handling, mounting and heat sink recommendations.

## Typical Radiation Pattern

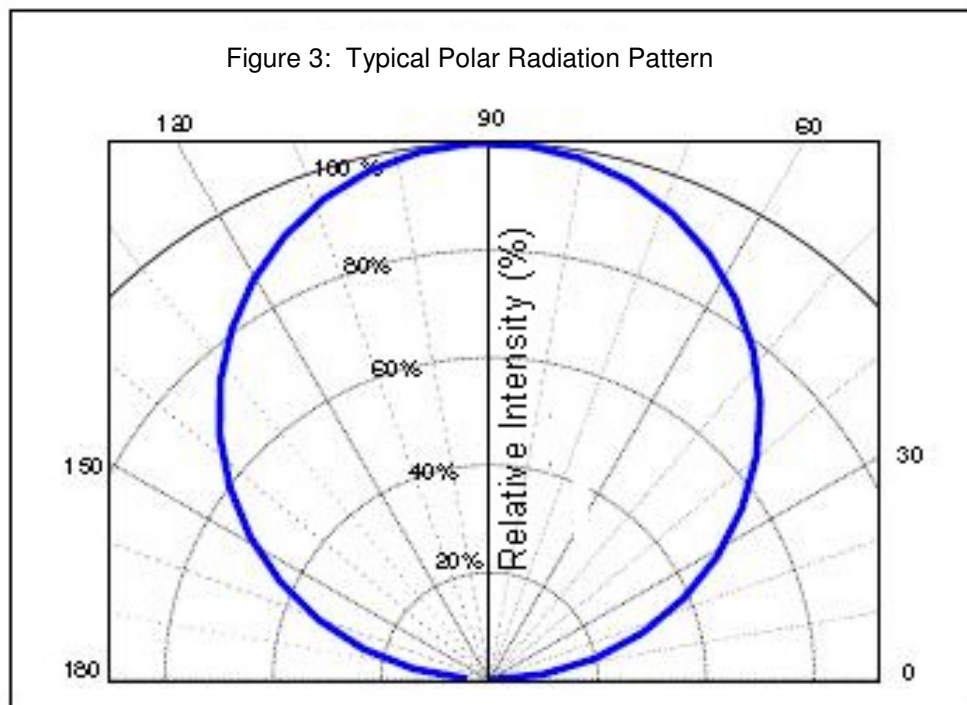
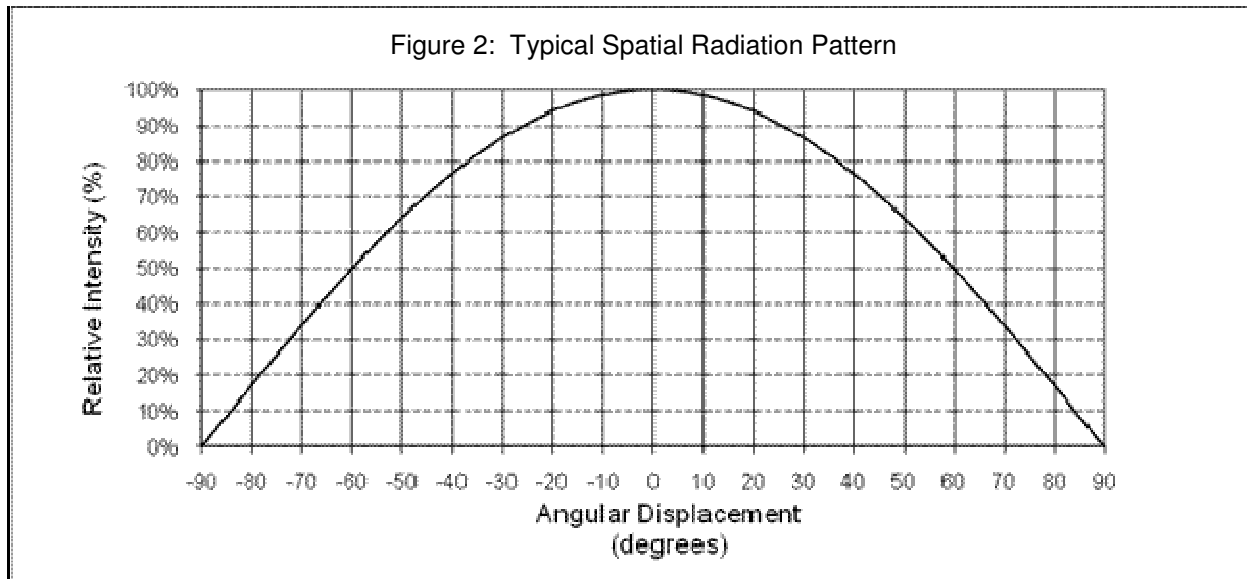



Wavelength Characteristics at Rated Test Current,  $T_j=25^\circ\text{C}$

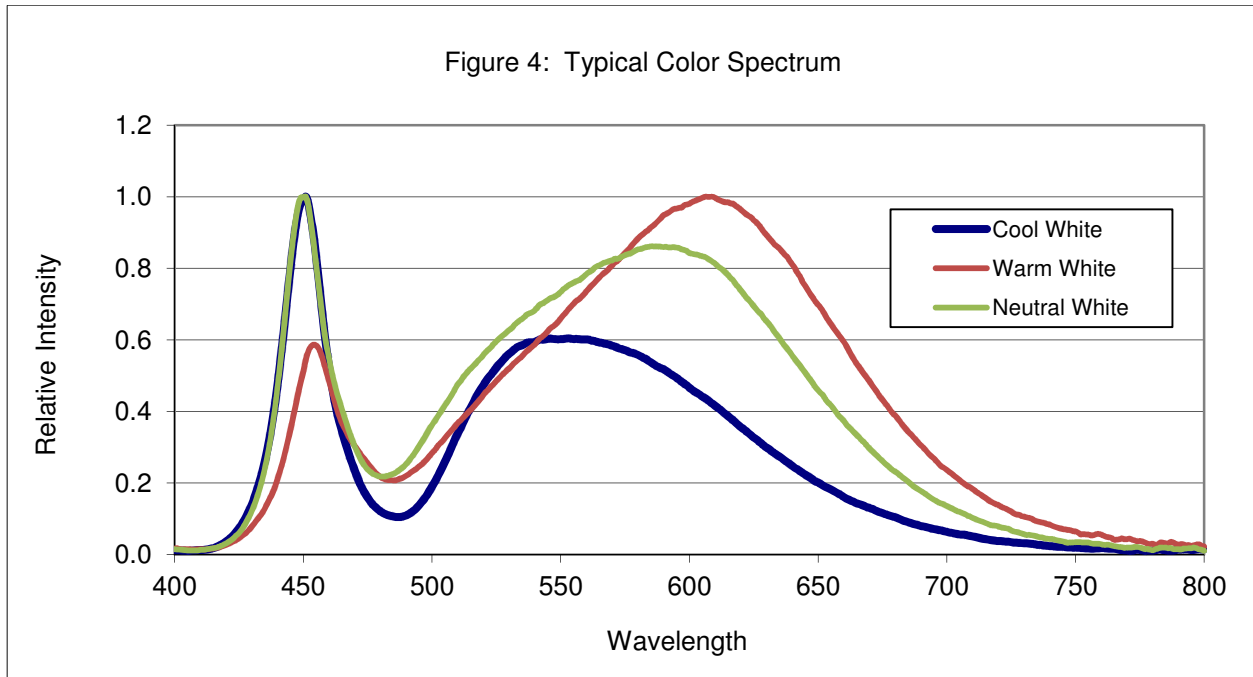

PRELIMINARY

Typical Relative Luminous Flux vs. Current, T<sub>j</sub>=25 °C

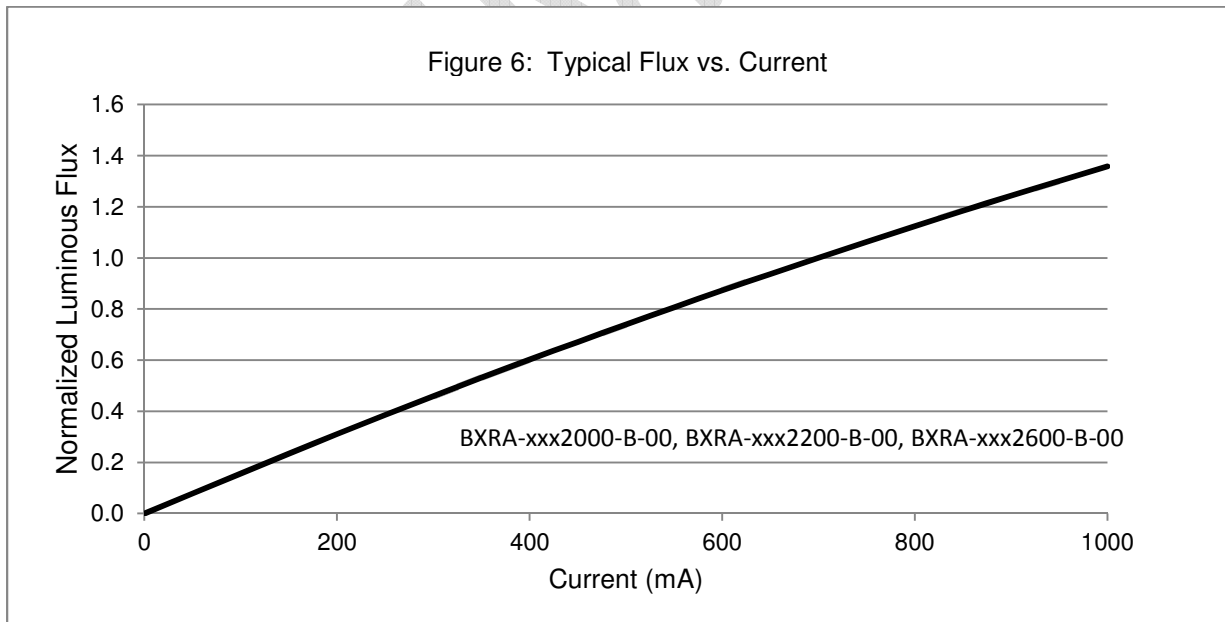
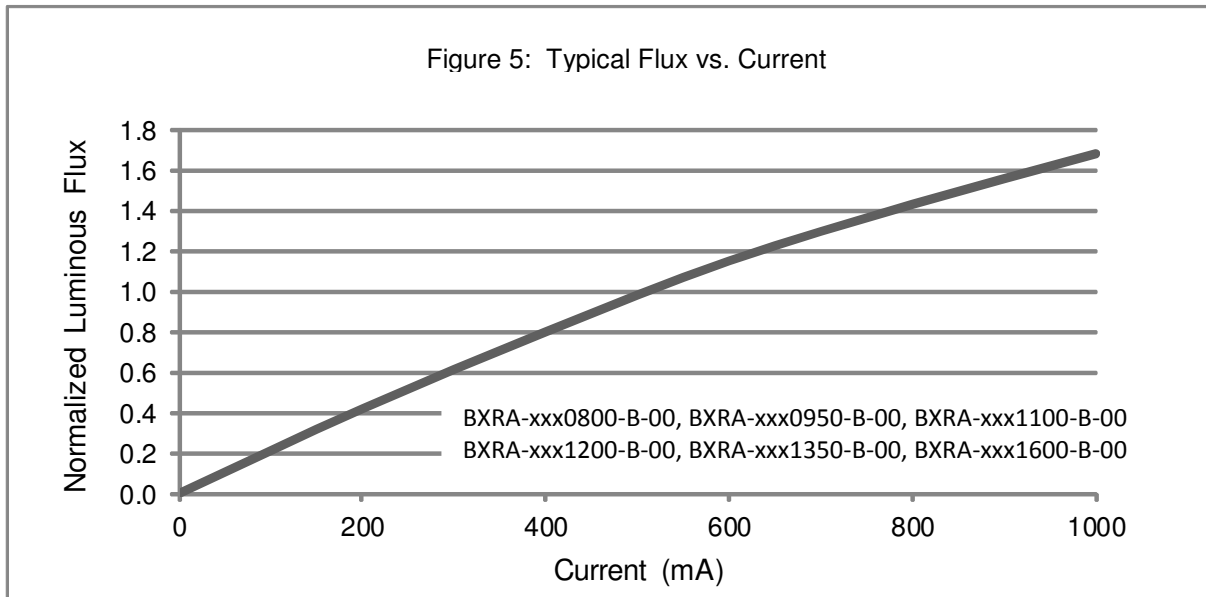

## Typical Light Output Characteristics vs. Temperature

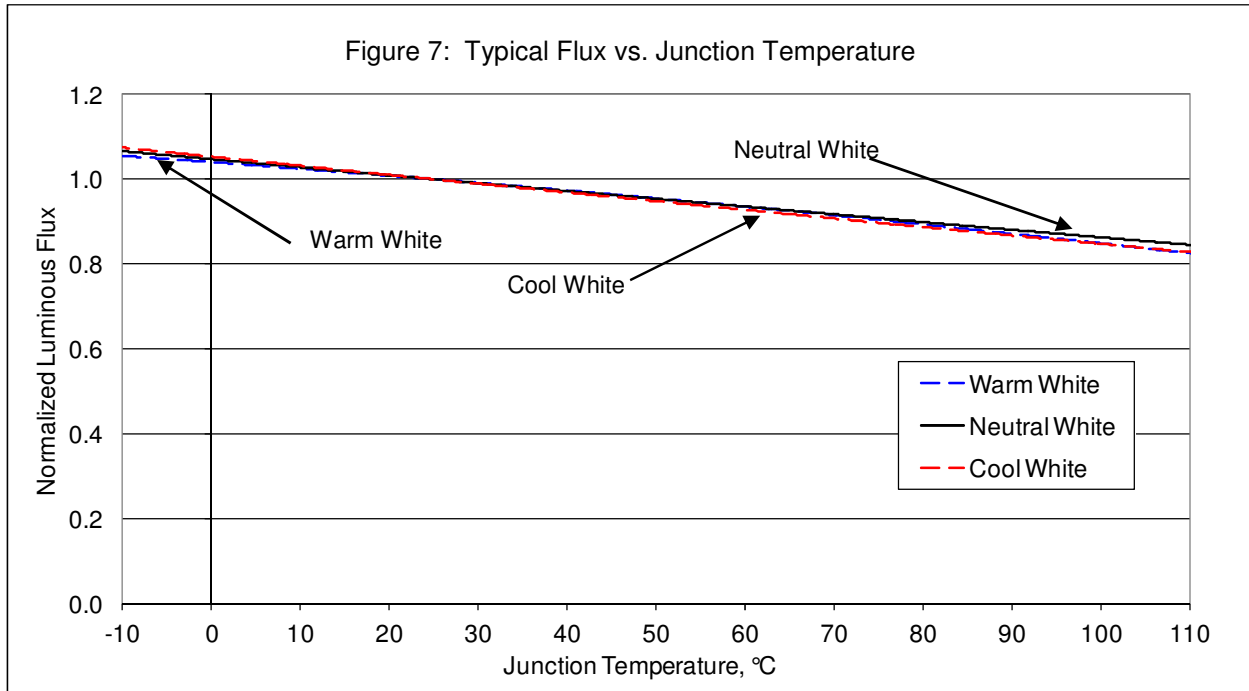

## Typical Chromaticity Characteristics vs. Temperature

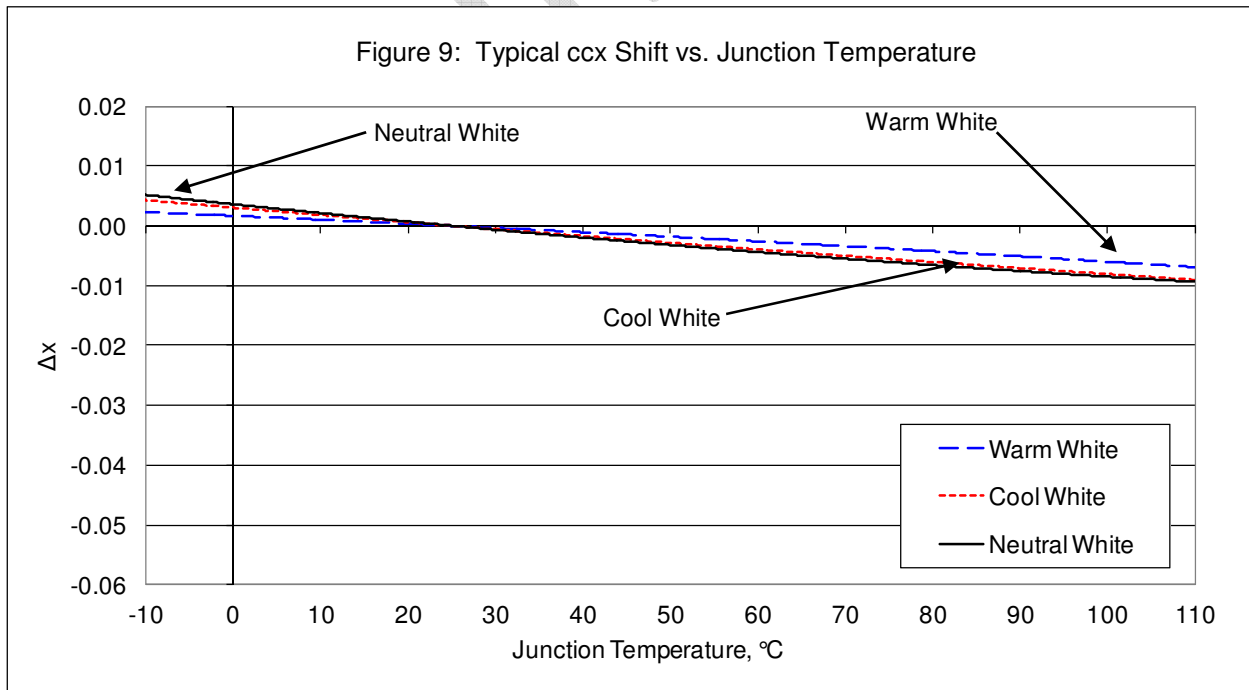
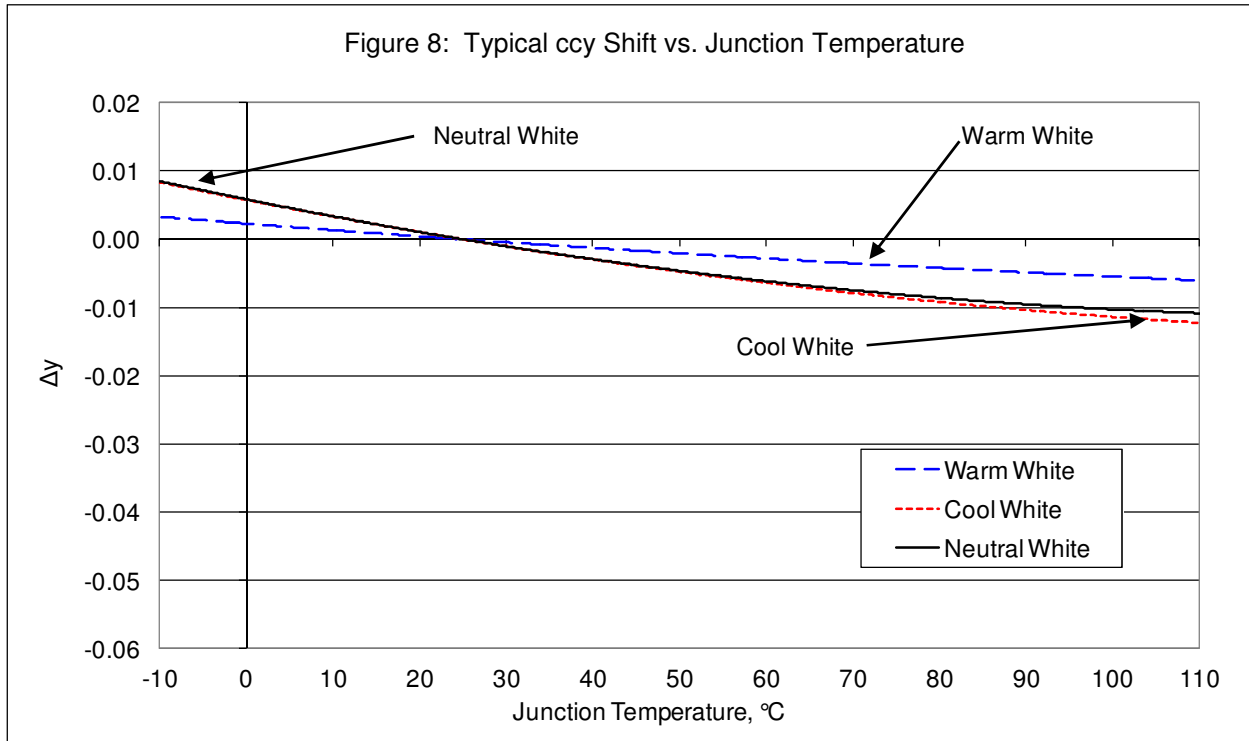

Forward Current Characteristics

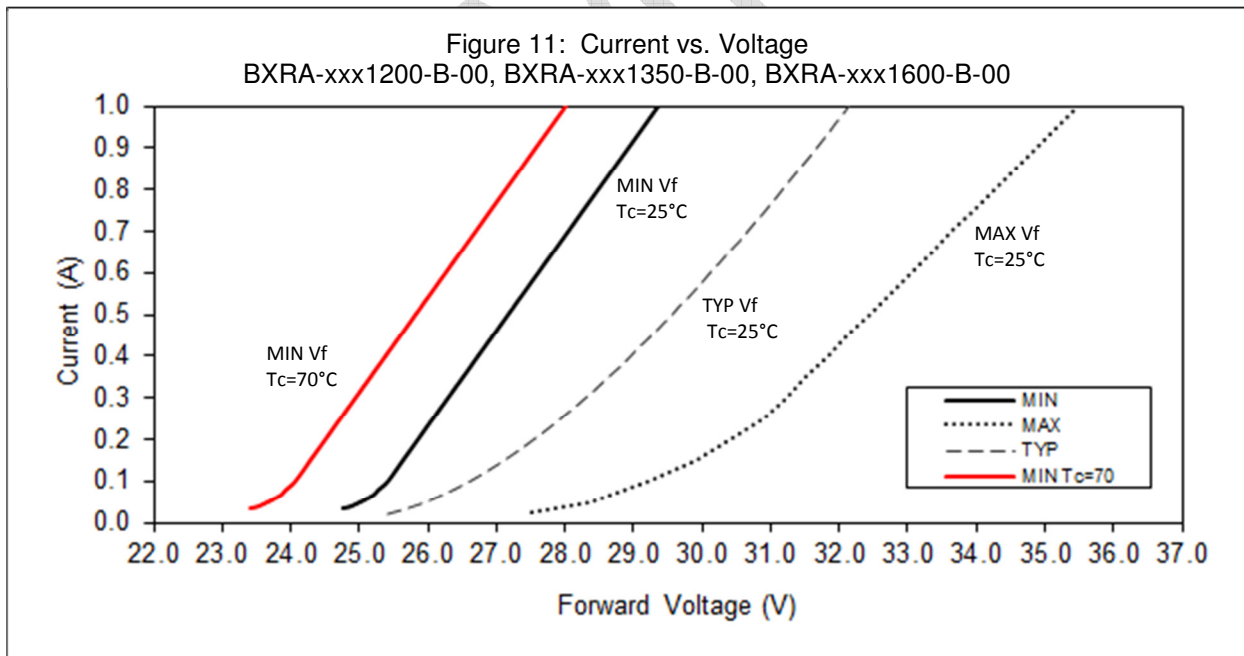
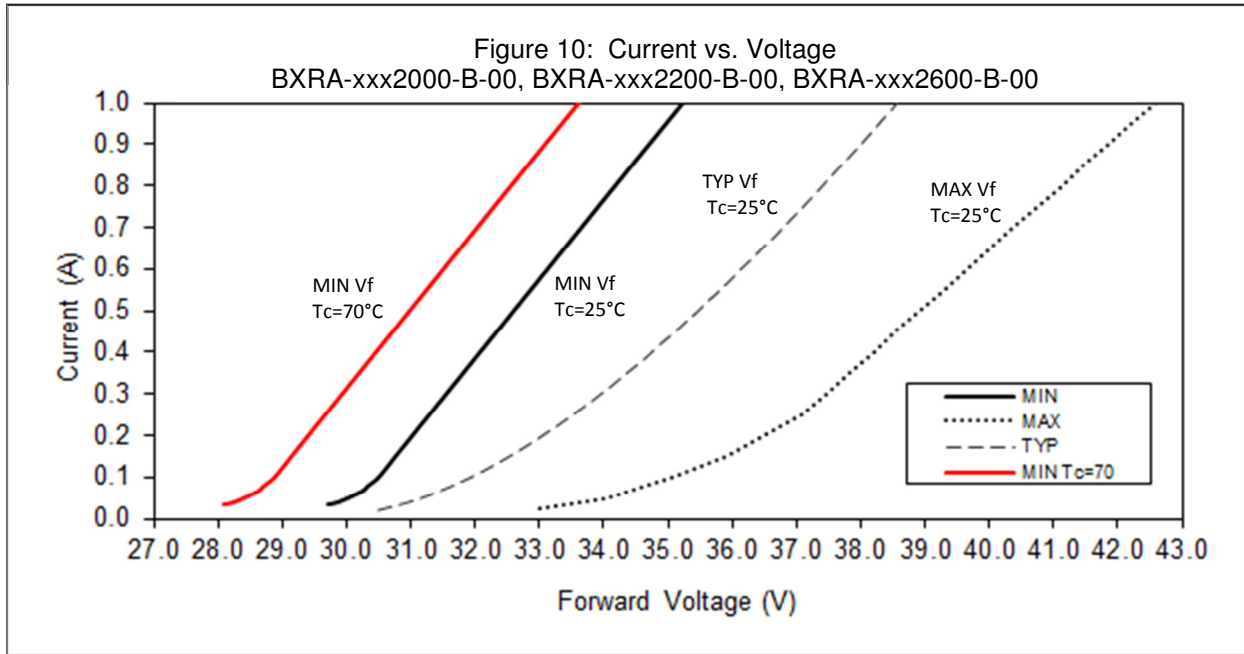

Forward Current Characteristics (continued)

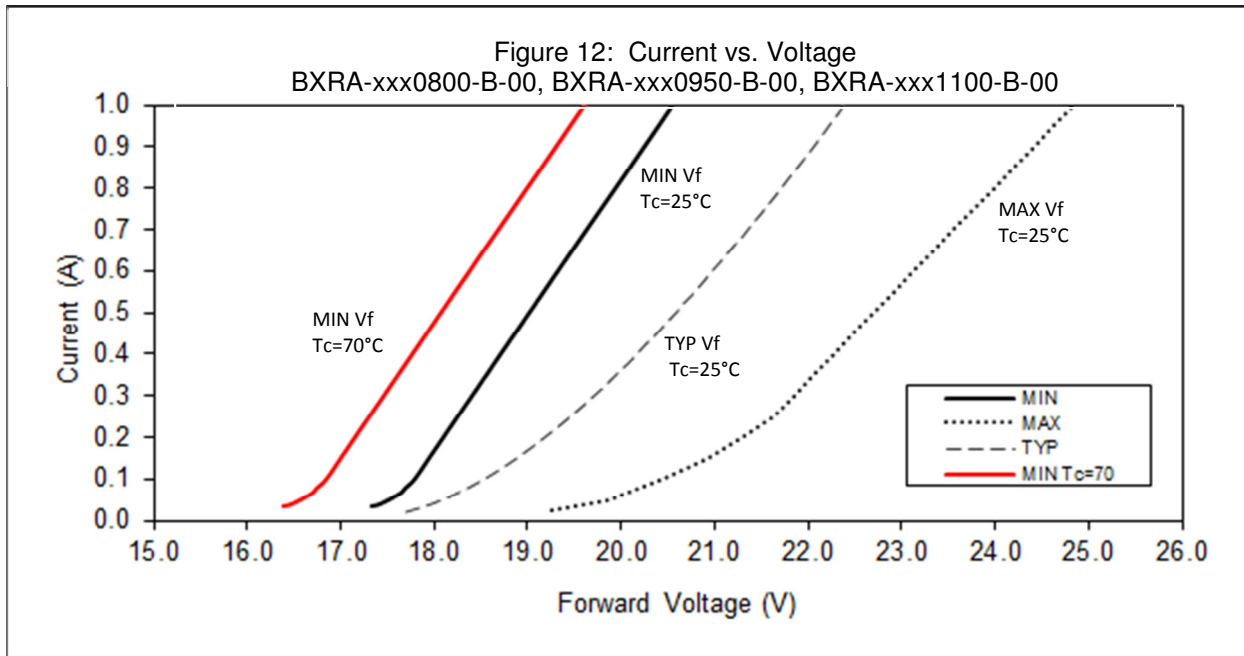

## Color Binning Information

Figure 13: Graph of Warm White Test Bins in xy Color Space

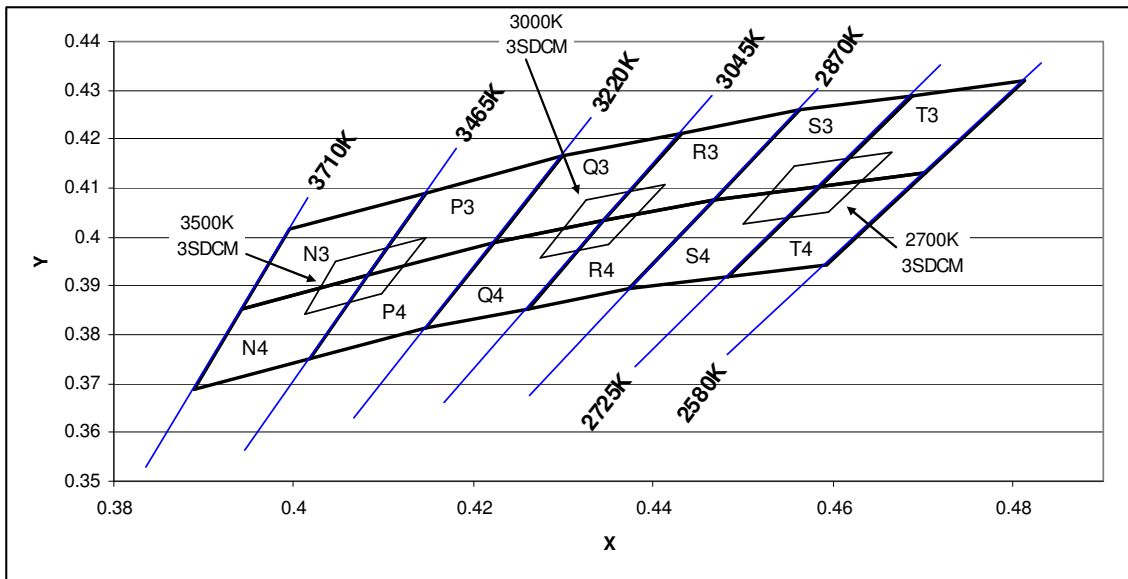

Table 10: Warm White xy Bin Coordinates and Associated Typical CCT

Bin Code	X	Y	ANSI CCT (K)	Bin Code	X	Y	ANSI CCT (K)	Bin Code	X	Y	ANSI CCT (K)
Q3	0.4223	0.3990	3000	S3	0.4468	0.4077	2700	N4	0.3943	0.3853	3500
	0.4299	0.4165			0.4562	0.4260			0.3996	0.4015	
	0.4431	0.4213			0.4688	0.4290			0.4148	0.4090	
	0.4345	0.4033			0.4585	0.4104			0.4083	0.3921	
Q4	0.4147	0.3814	3000	S4	0.4373	0.3893	2700	N3	0.3889	0.3690	3500
	0.4223	0.3990			0.4468	0.4077			0.3943	0.3853	
	0.4345	0.4033			0.4585	0.4104			0.4083	0.3921	
	0.4260	0.3854			0.4483	0.3919			0.4018	0.3752	
R3	0.4345	0.4033	3000	T4	0.4585	0.4104	2700	P3	0.4083	0.3921	3500
	0.4431	0.4213			0.4688	0.4290			0.4148	0.4090	
	0.4562	0.4260			0.4813	0.4319			0.4299	0.4165	
	0.4468	0.4077			0.4703	0.4132			0.4223	0.3990	
R4	0.4260	0.3854	3000	T3	0.4483	0.3919	2700	P4	0.4018	0.3752	3500
	0.4345	0.4033			0.4585	0.4104			0.4083	0.3921	
	0.4468	0.4077			0.4703	0.4132			0.4223	0.3990	
	0.4373	0.3893			0.4593	0.3944			0.4147	0.3814	
X3 (3SDCM)	0.4413	0.4107	3000	X3 (3SDCM)	0.4656	0.4174	2700	X3 (3SDCM)	0.4148	0.4000	3500
	0.4325	0.4075			0.4573	0.4154			0.4047	0.3950	
	0.4274	0.3958			0.4510	0.4032			0.4012	0.3841	
	0.4350	0.3984			0.4583	0.4049			0.4098	0.3883	

Color Binning Information (continued)

Figure 14: Graph of Neutral White Test Bins in xy Color Space

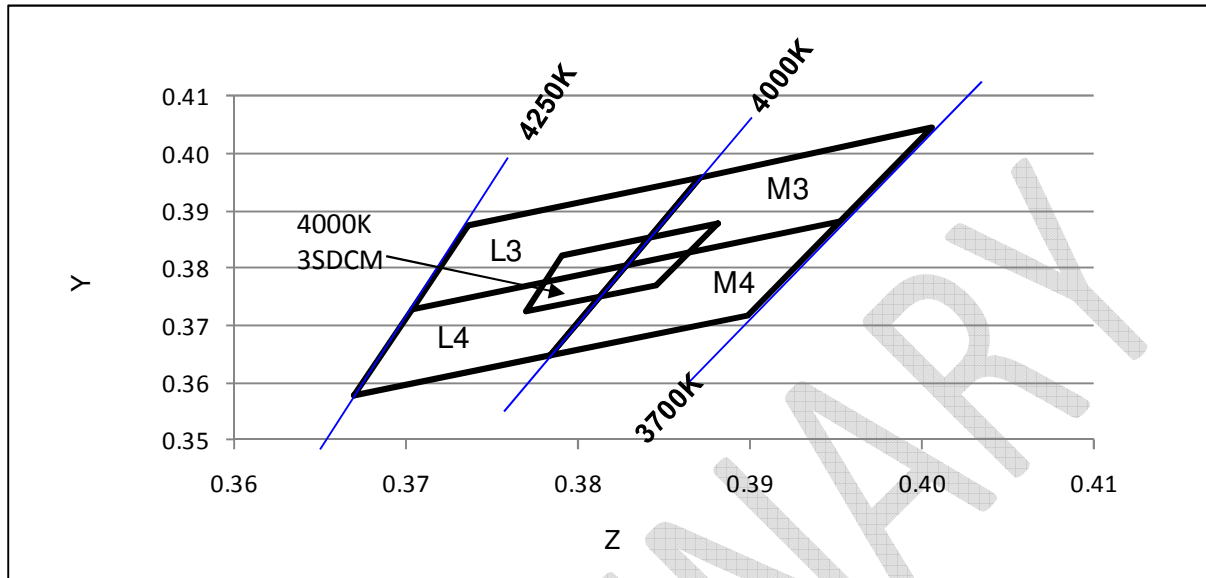

Table 11: Neutral White xy Bin Coordinates and Associated Typical CCT

Bin Code	X	Y	ANSI CCT (K)
L3	0.3703	0.3726	4000
	0.3736	0.3874	
	0.3871	0.3959	
	0.3828	0.3803	
L4	0.3670	0.3578	4000
	0.3703	0.3726	
	0.3828	0.3803	
	0.3784	0.3647	
M3	0.3828	0.3803	4000
	0.3871	0.3959	
	0.4006	0.4044	
	0.3952	0.3880	
M4	0.3784	0.3647	4000
	0.3828	0.3803	
	0.3952	0.3880	
	0.3898	0.3716	
X3 (3SDCM)	0.3881	0.3879	4000
	0.3791	0.3823	
	0.3769	0.3724	
	0.3845	0.3770	



Color Binning Information (continued)

Figure 15: Graph of Cool White Test Bins in xy Color Space

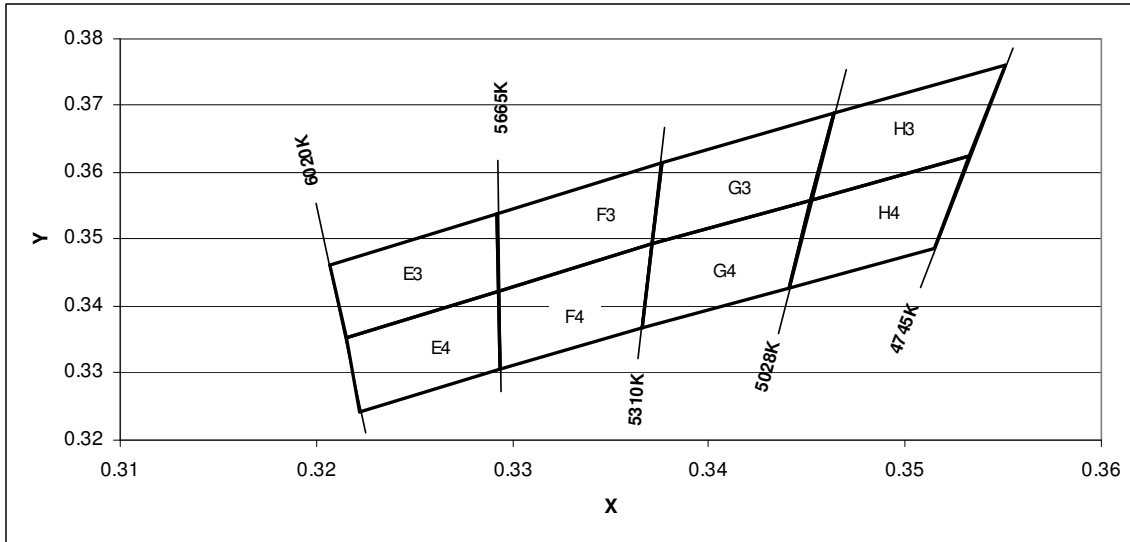

Table 12: Cool White xy Bin Coordinates and Associated Typical CCT

Bin Code	X	Y	ANSI CCT (K)
G3	0.3376	0.3616	5000
	0.3464	0.3688	
	0.3452	0.3558	
	0.3371	0.3493	
G4	0.3371	0.3493	5000
	0.3452	0.3558	
	0.3441	0.3428	
	0.3366	0.3369	
H3	0.3464	0.3688	5000
	0.3551	0.376	
	0.3533	0.3624	
	0.3452	0.3558	
H4	0.3452	0.3558	5000
	0.3533	0.3624	
	0.3515	0.3487	
	0.3441	0.3428	
E3	0.3215	0.3353	5600
	0.3293	0.3423	
	0.3292	0.3539	
	0.3207	0.3462	
E4	0.3222	0.3243	5600
	0.3294	0.3306	
	0.3293	0.3423	
	0.3215	0.3353	
F3	0.3292	0.3539	5600
	0.3293	0.3423	
	0.3371	0.3493	
	0.3376	0.3616	
F4	0.3294	0.3306	5600
	0.3366	0.3369	
	0.3371	0.3493	
	0.3293	0.3423	

---

## Design Resources

Bridgelux has developed a comprehensive set of application notes and design resources to assist customers in successfully designing with Bridgelux LED Array products. Included below is a list of available resources which can be downloaded from the Bridgelux web site under the Design Resources section. These documents are updated regularly as new information becomes available, including complimentary infrastructure products such as commercially available secondary optics and electronic driver solutions.

### Application Notes

- AN10: Effective Thermal Management of Bridgelux LED Arrays
- AN11: Assembly Considerations for Bridgelux LED Arrays
- AN12: Electrical Drive Considerations for Bridgelux LED Arrays
- AN14: Reliability Data Sheet for Bridgelux LED Arrays
- AN15: Reflow Soldering of Bridgelux LED Arrays
- AN16: Optical Considerations for Bridgelux LED Arrays

### Optical Source Models

Optical source models and ray set files are available for all Bridgelux LED Array products, and can be downloaded directly from the Bridgelux web site. The list below contains the formats currently available. If you require a specific format not included in this list, please contact your Bridgelux sales representative for assistance.

- Zemax
- ASAP
- IESNA
- LightTools
- LucidShape
- OPTIS SPEOS
- PHOTOPIA
- TracePro
- Radiant Imaging Source Model

### 3D CAD Models

Three dimensional CAD models depicting the product outline of all Bridgelux LED Arrays are available in both SAT and STEP formats. These CAD files can be downloaded directly from the Bridgelux web site.

---

## About Bridgelux

Bridgelux is a leading developer and manufacturer of technologies and solutions transforming the \$40 billion global lighting industry into a \$100 billion market opportunity. Based in Livermore, California, Bridgelux is a pioneer in solid-state lighting (SSL), expanding the market for light-emitting diode (LED) technologies by driving down the cost of LED lighting systems. Bridgelux's patented light source technology replaces traditional technologies (such as incandescent, halogen, fluorescent and high intensity discharge lighting) with integrated, solid-state lighting solutions that enable lamp and luminaire manufacturers to provide high performance and energy-efficient white light for the rapidly growing interior and exterior lighting markets, including street lights, commercial lighting and consumer applications. With more than 550 patent applications filed or granted worldwide, Bridgelux is the only vertically integrated LED manufacturer and developer of solid-state light sources that designs its solutions specifically for the lighting industry.

For more information about the company, please visit [www.bridgelux.com](http://www.bridgelux.com)

© 2012 Bridgelux, Inc. All rights reserved. Product specifications are subject to change without notice.

