



WTB4FT-1G31120ZZZ

W4F

MINIATURE PHOTOELECTRIC SENSORS

**SICK**  
Sensor Intelligence.



Illustration may differ



### Ordering information

Type	Part no.
WTB4FT-1G311120ZZZ	1113178

Other models and accessories → [www.sick.com/W4F](http://www.sick.com/W4F)

### Detailed technical data

#### Features

<b>Functional principle</b>	Photoelectric proximity sensor
<b>Functional principle detail</b>	Background suppression, DoubleLine
<b>Sensing range</b>	
Sensing range min.	7 mm
Sensing range max.	120 mm
Adjustable switching threshold for background suppression	15 mm ... 120 mm
Reference object	Object with 90% remission factor (complies with standard white according to DIN 5033)
Minimum distance between set sensing range and background (black 6% / white 90%)	1 mm, at a distance of 50 mm
Recommended sensing range for the best performance	30 mm ... 80 mm
<b>Emitted beam</b>	
Light source	PinPoint LED
Type of light	Visible red light
Shape of light spot	Line-shaped, two parallel line-shaped light spots
Light spot size (distance)	1.2 mm x 17 mm (50 mm)
Maximum dispersion of the emitted beam around the standardized transmission axis (squint angle)	< +/- 1.5° (at Ta = +23 °C)
<b>Key LED figures</b>	
Normative reference	EN 62471:2008-09   IEC 62471:2006, modified

LED risk group marking	Free group
Wave length	635 nm
Average service life	100,000 h at $T_a = +25\text{ °C}$
<b>Smallest detectable object (MDO) typ.</b>	1 mm (At 50 mm distance (object with 90% remission (complies with standard white according to DIN 5033)))
<b>Adjustment</b>	
Teach-Turn adjustment	BluePilot: For setting the sensing range
<b>Indication</b>	
LED blue	BluePilot: sensing range indicator
LED green	Operating indicator Static on: power on
LED yellow	Status of received light beam Static on: object present Static off: object not present
<b>Special applications</b>	Detecting flat objects, Detecting objects wrapped in film, Detecting perforated objects, Detecting uneven, shiny objects

### Safety-related parameters

<b>MTTF<sub>D</sub></b>	661 years
<b>DC<sub>avg</sub></b>	0 %
<b>T<sub>M</sub> (mission time)</b>	20 years (EN ISO 13849) Rate of use: 60 %

### Electrical data

<b>Supply voltage U<sub>B</sub></b>	10 V DC ... 30 V DC <sup>1)</sup>
<b>Ripple</b>	≤ 5 V <sub>pp</sub>
<b>Usage category</b>	DC-12 (According to EN 60947-5-2) DC-13 (According to EN 60947-5-2)
<b>Current consumption</b>	≤ 25 mA, without load. At U <sub>B</sub> = 24 V
<b>Protection class</b>	III
<b>Digital output</b>	
Number	1
Type	Push-pull: PNP/NPN
Signal voltage PNP HIGH/LOW	Approx. U <sub>B</sub> -2.5 V / 0 V
Signal voltage NPN HIGH/LOW	Approx. U <sub>B</sub> / < 2.5 V
Output current I <sub>max.</sub>	≤ 100 mA
Circuit protection outputs	Reverse polarity protected Overcurrent protected Short-circuit protected
Response time	≤ 1,000 μs <sup>2)</sup>
Repeatability (response time)	240 μs
Switching frequency	500 Hz <sup>3)</sup>
<b>Pin/Wire assignment</b>	

<sup>1)</sup> Limit values.

<sup>2)</sup> Signal transit time with resistive load in switching mode.

<sup>3)</sup> With light/dark ratio 1:1.

Function of pin 4/black (BK)	Digital output, light switching, object present → output Q HIGH
------------------------------	---

- 1) Limit values.
- 2) Signal transit time with resistive load in switching mode.
- 3) With light/dark ratio 1:1.

**Mechanical data**

<b>Housing</b>	Rectangular
<b>Dimensions (W x H x D)</b>	16 mm x 40.1 mm x 12.1 mm
<b>Connection</b>	Cable, 3-wire, 2 m
<b>Connection detail</b>	
Deep-freeze property	Do not bend below 0 °C
Conductor size	0.14 mm <sup>2</sup>
Cable diameter	Ø 3.4 mm
Length of cable (L)	2 m
<b>Material</b>	
Housing	Plastic, VISTAL®
Front screen	Plastic, PMMA
Cable	PVC
<b>Weight</b>	Approx. 30 g
<b>Maximum tightening torque of the fixing screws</b>	0.4 Nm

**Ambient data**

<b>Enclosure rating</b>	IP66 (EN 60529) IP67 (EN 60529)
<b>Ambient operating temperature</b>	-40 °C ... +60 °C
<b>Ambient temperature, storage</b>	-40 °C ... +75 °C
<b>Typ. Ambient light immunity</b>	Artificial light: ≤ 50,000 lx Sunlight: ≤ 50,000 lx
<b>Shock resistance</b>	30 g, 11 ms (3 positive and 3 negative shocks along X, Y, Z axes, 18 total shocks (EN60068-2-27))
<b>Vibration resistance</b>	10 Hz ... 1,000 Hz (Amplitude 1 mm, 3 x 30 min (EN60068-2-6))
<b>Air humidity</b>	35 % ... 95 %, Relative humidity (no condensation)
<b>Electromagnetic compatibility (EMC)</b>	EN 60947-5-2
<b>Resistance to cleaning agent</b>	ECOLAB
<b>UL File No.</b>	NRKH.E181493 & NRKH7.E181493

**Classifications**

<b>eCl@ss 5.0</b>	27270904
<b>eCl@ss 5.1.4</b>	27270904
<b>eCl@ss 6.0</b>	27270904
<b>eCl@ss 6.2</b>	27270904
<b>eCl@ss 7.0</b>	27270904
<b>eCl@ss 8.0</b>	27270904
<b>eCl@ss 8.1</b>	27270904
<b>eCl@ss 9.0</b>	27270904

<b>eCl@ss 10.0</b>	27270904
<b>eCl@ss 11.0</b>	27270904
<b>eCl@ss 12.0</b>	27270903
<b>ETIM 5.0</b>	EC002719
<b>ETIM 6.0</b>	EC002719
<b>ETIM 7.0</b>	EC002719
<b>ETIM 8.0</b>	EC002719
<b>UNSPSC 16.0901</b>	39121528

## Connection type

Cable, 3-wire

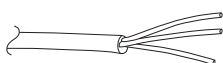

## Connection diagram

Cd-043

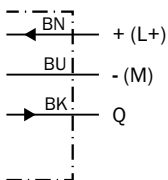

## Truth table

Push-pull: PNP/NPN – dark switching  $\bar{Q}$

	Dark switching $\bar{Q}$ (normally closed (upper switch), normally open (lower switch))	
	Object not present → Output HIGH	Object present → Output LOW
Light receive	✗	✔
Light receive indicator	✗	☀
Load resistance to L+	✗	⚠
Load resistance to M	⚠	✗

### Push-pull: PNP/NPN - light switching Q

	Light switching Q (normally open (upper switch), normally closed (lower switch))	
	Object not present → Output LOW	Object present → Output HIGH
Light receive	⊗	☑
Light receive indicator	⊗	☑
Load resistance to L+	⚠	⊗
Load resistance to M	⊗	⚠

### Characteristic curve

Minimum distance in mm (y) between the set sensing range and white background (90 % remission)

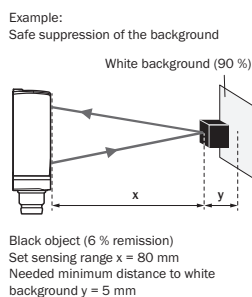
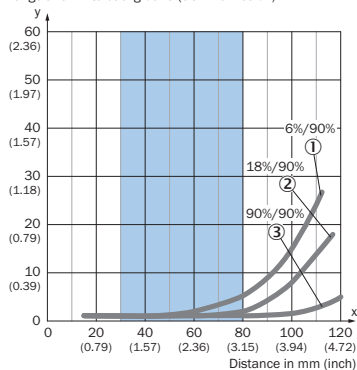

Recommended sensing range for the best performance

- ① Black object, 6% remission factor
- ② Gray object, 18% remission factor
- ③ White object, 90% remission factor

### Light spot size

#### Vertical

Dimensions in mm (inch)

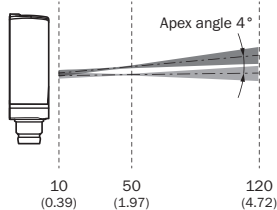
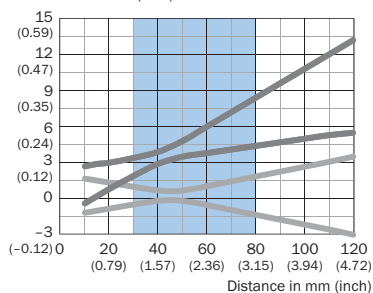

Recommended sensing range for the best performance

Horizontal

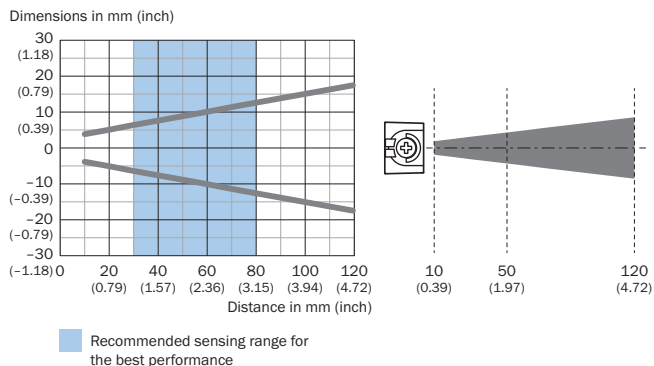

Sensing range diagram

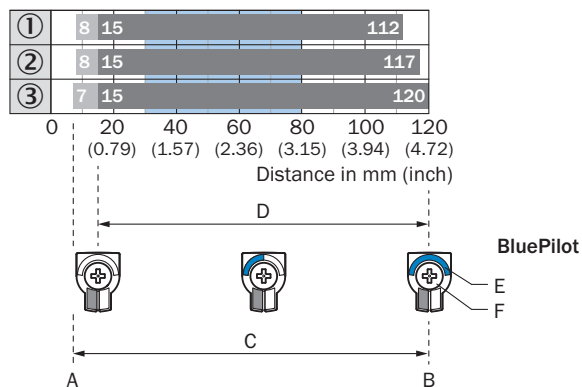

- A = Sensing range min. in mm
- B = Sensing range max. in mm
- C = Viewing range
- D = Adjustable switching threshold for background suppression
- E = Sensing range indicator
- F = Teach-Turn adjustment

Recommended sensing range for the best performance

- ① Black object, 6% remission factor
- ② Gray object, 18% remission factor
- ③ White object, 90% remission factor

## Adjustments

Display and adjustment elements

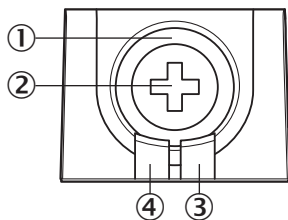

- ① LED blue
- ② Teach-Turn adjustment
- ③ LED yellow
- ④ LED green

## Dimensional drawing (Dimensions in mm (inch))

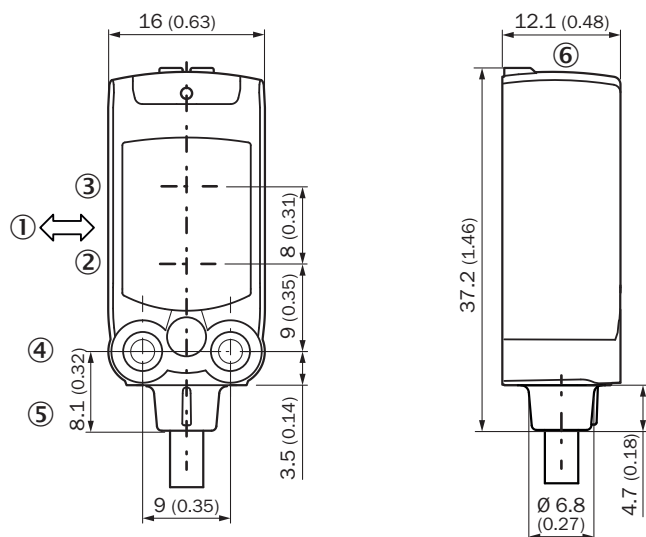

- ① Standard direction of the material being detected
- ② Center of optical axis, sender
- ③ Center of optical axis, receiver
- ④ M3 mounting hole
- ⑤ Connection
- ⑥ Display and adjustment elements

## Recommended accessories

Other models and accessories → [www.sick.com/W4F](http://www.sick.com/W4F)

	Brief description	Type	Part no.
Mounting brackets and plates			
	Mounting bracket for wall mounting, Stainless steel 1.4571, mounting hardware included	BEF-W4-A	2051628



	<b>Brief description</b>	<b>Type</b>	<b>Part no.</b>
Plug connectors and cables			
	Head A: male connector, M8, 3-pin, straight Cable: unshielded	STE-0803-G	6037322

## SICK AT A GLANCE

SICK is one of the leading manufacturers of intelligent sensors and sensor solutions for industrial applications. A unique range of products and services creates the perfect basis for controlling processes securely and efficiently, protecting individuals from accidents and preventing damage to the environment.

We have extensive experience in a wide range of industries and understand their processes and requirements. With intelligent sensors, we can deliver exactly what our customers need. In application centers in Europe, Asia and North America, system solutions are tested and optimized in accordance with customer specifications. All this makes us a reliable supplier and development partner.

Comprehensive services complete our offering: SICK LifeTime Services provide support throughout the machine life cycle and ensure safety and productivity.

For us, that is “Sensor Intelligence.”

## WORLDWIDE PRESENCE:

Contacts and other locations –[www.sick.com](http://www.sick.com)