

1 2 3 4 5 6

A

B

C

D

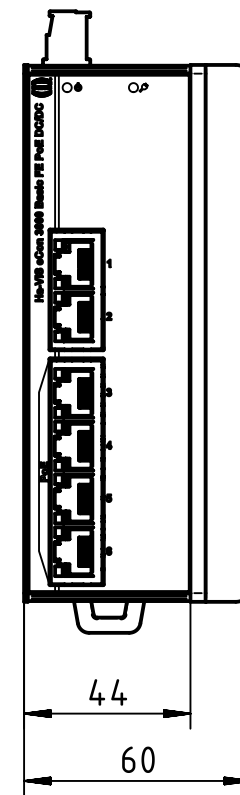
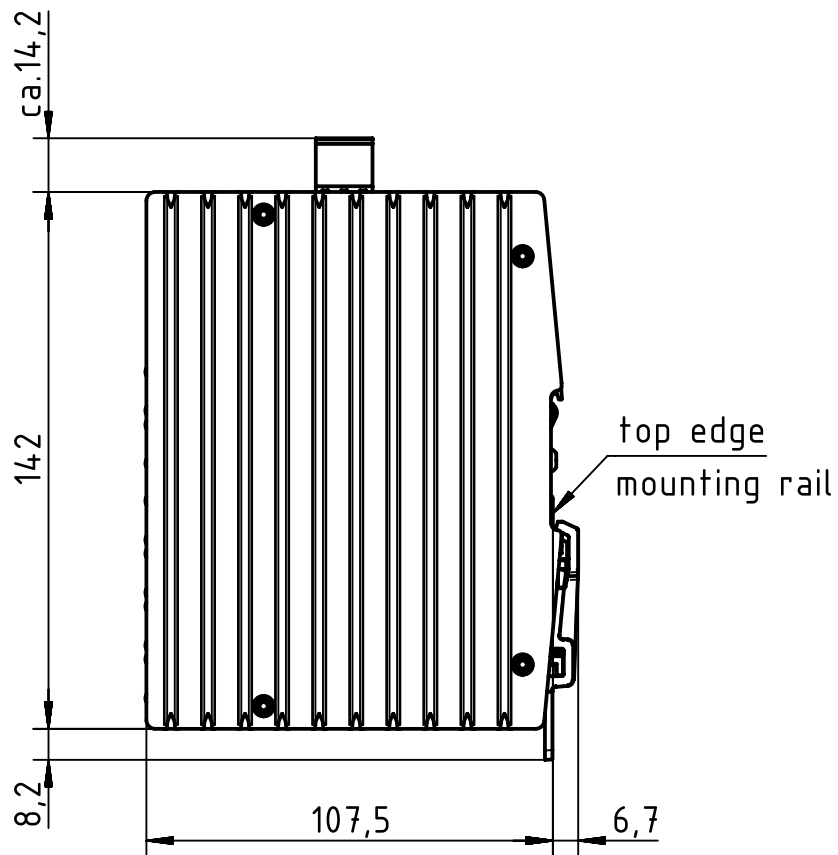
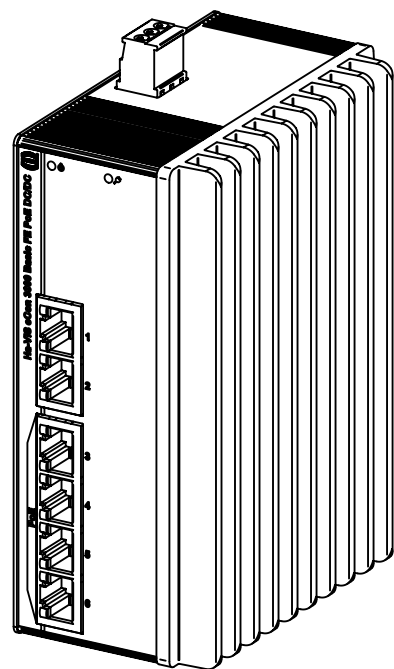

for mounting rail acc. to DIN EN 60715

	All Dimensions in mm Original Size DIN A4		Scale 1:2	Free size tol.		Ref. Sub.			
		All rights reserved Department EL PD - DE		Created by STICKFORTH	Inspected by WULF	Standardisation RUETERA	Date 2015-07-23	State Final Release	
HARTING Electric GmbH & Co. KG D-32339 Espelkamp				Title Ha-VIS eCon 3060B-A-PP			Doc-Key / ECM-Nr. 100627441/UGD/002/A 500000092178		
				Type TB	Number 24 03 106 0030			Rev. A	Page 1/1