

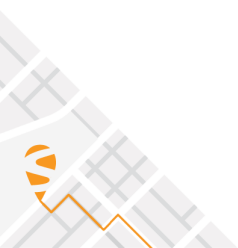

mosaic-X5 Reference Guide

Applicable to version 4.8.2 of the Firmware



mosaic-X5 Reference Guide

2020-12-03

Applicable to version 4.8.2 of the Firmware

© Copyright 2000-2020-12-03 Septentrio NV/SA. All rights reserved.

Septentrio NV
Greenhill Campus, Interleuvenlaan 15i
3001 Leuven, Belgium

<http://www.septentrio.com>

Phone: +32 16 300 800

Fax: +32 16 221 640

 @Septentrio

List of Contents

CONTENTS	6
SCOPE	7
LIST OF ACRONYMS	8
1 How To...	12
1.1 CONNECT TO THE RECEIVER	13
1.1.1 Via COM Ports	13
1.1.2 Via USB	13
1.1.3 Via a TCP/IP Port.....	13
1.1.3.1 Ethernet	13
1.1.3.2 Ethernet-over-USB	14
1.1.3.3 Point-to-Point Link	14
1.1.4 Via a Web Browser	14
1.1.5 Connection Descriptors	15
1.2 UNDERSTAND THE OUTPUT OF THE RECEIVER	16
1.2.1 Proprietary Binary Output (SBF).....	16
1.2.2 NMEA	16
1.2.3 RTCM and CMR	17
1.3 DEFINE AN SBF OUTPUT STREAM	18
1.4 SAVE THE CONFIGURATION IN NON-VOLATILE MEMORY	19
1.5 CONFIGURE THE RECEIVER IN DGPS/RTK-BASE MODE	20
1.5.1 Static Base Station Mode.....	20
1.5.2 RTK Moving Base Station Mode	21
1.6 CONFIGURE THE RECEIVER IN DGPS/RTK-ROVER MODE	23
1.7 DETERMINE A GNSS-BASED ATTITUDE FROM A MOVING BASE	24
1.8 CONFIGURE THE RECEIVER IN NTRIP SERVER MODE	26
1.9 CONFIGURE THE RECEIVER IN NTRIP CLIENT MODE	27
1.10 USE THE BUILT-IN NTRIP CASTER	28
1.10.1 Broadcasting Local Streams	28
1.10.2 Broadcasting Remote Streams	28
1.11 CONFIGURE AN IP SERVER PORT	30
1.12 CONFIGURE AN IP RECEIVE PORT	31
1.13 LOG SBF OR NMEA	32
1.14 LOG RINEX FILES	33

1.15	DOWNLOAD LOG FILES FROM THE RECEIVER	34
1.16	FTP PUSH LOG FILES.....	36
1.17	COMMUNICATE WITH EXTERNAL EQUIPMENT	37
1.18	GENERATE A "PULSE PER SECOND" SIGNAL	38
1.19	TIME TAG EXTERNAL EVENTS.....	39
1.20	MONITOR THE RF SPECTRUM	40
1.21	MANAGE USERS	41
1.22	UPGRADE THE RECEIVER.....	42
1.23	CHECK THE CAPABILITIES OF YOUR RECEIVER	43
1.24	CHECK OR CHANGE THE PERMISSION FILE.....	44
2	Operation Details	45
2.1	CHANNEL ALLOCATION AND SIGNAL SELECTION	45
2.2	GENERATION OF MEASUREMENTS	45
2.2.1	Pilot vs. Data Component.....	46
2.3	TIME MANAGEMENT	47
2.3.1	Free-Running Clock	47
2.3.2	Clock Steering.....	48
2.4	COMPUTATION OF POSITION, VELOCITY, AND TIME (PVT SOLUTION)	49
2.4.1	SBAS Positioning	50
2.4.2	DGPS Positioning.....	50
2.4.3	RTK Positioning	50
2.4.3.1	Integer Ambiguities (RTK-fixed).....	51
2.4.3.2	Floating Ambiguities (RTK-float)	51
2.4.3.3	Moving Base.....	51
2.4.4	Transition between PVT Modes	52
2.4.5	Datum Transformation	52
2.4.5.1	Transformation to Regional Datum	52
2.4.5.2	Transformation to Local Datum	52
2.5	ANTENNA EFFECTS	53
2.5.1	Antenna Effects in Rover Mode	54
2.5.2	Antenna Effects in Base Mode.....	54
3	Command Line Reference	55
3.1	COMMAND LINE INTERFACE OUTLINE	56
3.1.1	Command Types	56
3.1.2	Command Line Syntax.....	56
3.1.3	Command Replies.....	57
3.1.4	Command Syntax Tables	58
3.2	COMMAND DEFINITIONS	61
3.2.1	Receiver Administration.....	61
3.2.2	Standby and Sleep Configuration	78
3.2.3	User Management	79
3.2.4	Tracking and Measurement Generation	84

3.2.5	Frontend and Interference Mitigation	96
3.2.6	Navigation Filter	100
3.2.7	Attitude Determination.....	125
3.2.8	Datum Definition	128
3.2.9	Transformation to Local Coordinates	133
3.2.10	Timing and Time Management.....	137
3.2.11	Station Settings	143
3.2.12	General Input/Output	146
3.2.13	NTRIP Settings	165
3.2.14	NMEA Configuration	172
3.2.15	SBF Configuration	178
3.2.16	RTCM v2.x Settings	185
3.2.17	RTCM v3.x Settings	192
3.2.18	CMR v2.0 Settings	200
3.2.19	Internal Disk Logging	205
3.2.20	FTP Push of Log Files.....	216
3.2.21	MSS/L-Band Configuration	219
3.2.22	PinPoint-GIS RX Configuration.....	222
3.2.23	Cosmos Configuration.....	232
4	SBF Reference	233
4.1	SBF OUTLINE.....	234
4.1.1	SBF Block Header Format	234
4.1.2	SBF Block Names and Numbers.....	234
4.1.3	SBF Block Time Stamp (TOW and WNC)	235
4.1.4	Sub-blocks.....	236
4.1.5	Padding Bytes.....	236
4.1.6	SBF Revision Number	236
4.1.7	Do-Not-Use Value	236
4.1.8	Output Rate	236
4.1.9	Satellite ID and GLONASS Frequency Number	237
4.1.10	Signal Type	238
4.1.11	Channel Numbering	239
4.1.12	Decoding of SBF Blocks.....	239
4.2	SBF BLOCK DEFINITIONS.....	241
4.2.1	Measurement Blocks	241
4.2.2	Navigation Page Blocks.....	256
4.2.3	GPS Decoded Message Blocks.....	271
4.2.4	GLONASS Decoded Message Blocks.....	276
4.2.5	Galileo Decoded Message Blocks	279
4.2.6	BeiDou Decoded Message Blocks.....	288
4.2.7	QZSS Decoded Message Blocks	293
4.2.8	SBAS L1 Decoded Message Blocks.....	296
4.2.9	Position, Velocity and Time Blocks	310
4.2.10	GNSS Attitude Blocks	348
4.2.11	Receiver Time Blocks	351
4.2.12	External Event Blocks	353
4.2.13	Differential Correction Blocks	368
4.2.14	L-Band Demodulator Blocks	373
4.2.15	Status Blocks.....	376
4.2.16	Miscellaneous Blocks	401

4.2.17 PinPoint-GIS RX	409
4.3 SBF CHANGE LOG	411
A Attitude Angles	413
B List of SBF Blocks	415
C List of NMEA Sentences	419
C.1 PROPRIETARY NMEA SENTENCES	420
C.1.1 HRP : Heading, Roll Pitch	420
C.1.2 RBD : Rover-Base Direction	421
C.1.3 RBP : Rover-Base Position	421
C.1.4 RBV : Rover-Base Velocity	422
C.1.5 SNC : NTRIP Client Status	422
C.1.6 TFM : Used RTCM Coordinate Transformation Messages	423
D List of CMR and RTCM Messages	424
D.1 CMR MESSAGES	424
D.2 RTCM v2.X MESSAGES	424
D.3 RTCM v3.X MESSAGES	425
INDEX OF COMMANDS	428
INDEX OF SBF BLOCKS	438

Scope

This document contains reference information about the receiver firmware.

Chapter 1 provides a set of step-by-step "how-to's" to help you find your way around the receiver's commands and logs.

Chapter 2 provides some background on the main algorithms running in the receiver and on the way to configure them.

Chapter 3 contains the complete description of the user command interface.

Chapter 4 contains the complete description of the SBF format.

Typographical Conventions

- abc** User command name. Clicking a command name redirects to the full command description.
- abc* Command argument name.
- abc Command replies.
- abc SBF block name or SBF field name. Clicking an SBF block name redirects to the full SBF block description.

List of Acronyms

Abbreviation	Description
AGC	Automatic Gain Control
ARP	Antenna Reference Point
ASCII	American Standard Code for Information Interchange
ASN.1	Abstract Syntax Notation One
BeiDou	BeiDou Navigation System
BGD	Broadcast Group Delay
CA	Coarse Acquisition
CGGTTS	Common GPS GLONASS Time Transfer Standard
CMR	Compact Measurement Record
COG	Course Over Ground
CPU	Central Processing Unit
CRC	Cyclic Redundancy Check
CSV	Comma-Separated Values
DGPS	Differential GPS
DHCP	Dynamic Host Configuration Protocol
DLL	Dynamically Linked Library
DNS	Domain Name Server
DOP	Dilution Of Precision
DVS	Data Validity Status
ECEF	Earth-Centered Earth-Fixed
EGNOS	European Geostationary Navigation Overlay System
ENU	East-North-Up
FTP	File Transfer Protocol

GEO	Geostationary Earth Orbiter
GIS	Geographical Information System
GLONASS	Global Orbiting Navigation Satellite System
GNSS	Global Navigation Satellite System
GPS	Global Positioning System
GST	Galileo System Time
GUI	Graphical User Interface
HDOP	Horizontal DOP
HMI	Hazardously Misleading Information
HPCA	HMI Probability Computation Algorithm
HPL	Horizontal Protection Level
HS	Health Status
ICD	Interface Control Document
IEEE	Institute of Electrical and Electronics Engineers
IERS	International Earth Rotation Service
IF	Intermediate Frequency
IGP	Ionospheric Grid Point
IGS	International GPS Service
IMU	Inertial Measurement Unit
INS	Inertial Navigation System
IODC	Issue of Data - Clock
IODE	Issue Of Data Ephemeris
IP	Internet Protocol
IRNSS	Indian Regional Navigational Satellite System
ITRF	International Terrestrial Reference Frame
ITRS	International Terrestrial Reference System
LBand	L-Band Receiver
L1	L1 carrier
L2	L2 carrier
L2C	L2C code
LED	Light Emitting Diode
LSB	Least Significant Bit
MIB	Management Information Base

MSB	Most Significant Bits
MT	Message Type
NATO	North Atlantic Treaty Organisation
NAV	Navigation
NavIC	Navigation with Indian Constellation
NAVSTAR	Navigation Satellite Timing And Ranging
NMEA	National Marine Electronics Association
P	P(Y) code
P1	P1 code
P2	P2 code
PC	Phase Center
PDOP	Position DOP
PLL	Phase Locked Loop
PPP	Precise Point Positioning
PPS	Pulse Per Second
PRC	Pseudorange Correction
PRN	Pseudo Random Noise
PVT	Position, Velocity and Time
QZSS	Quasi-Zenith Satellite System
RAIM	Receiver Autonomous Integrity Monitoring
RINEX	Receiver Independent Exchange Format
RTCA	Radio Technical Commission for Aeronautics
RTCM	Radio Technical Commission for Maritime Services
RTK	Real-Time Kinematic
SBAS	Space-Based Augmentation System
SBF	Septentrio Binary Format
SIS	Signal In Space
SISA	Signal in Space Accuracy
SNMP	Simple Network Management Protocol
SV	Space Vehicle
SVID	Space Vehicle ID
TDOP	Time DOP
TOW	Time Of Week

UDRE	User Differential Range Error
UERE	User Equivalent Range Error
UHF	Ultra High Frequency
URA	User Range Accuracy
USB	Universal Serial Bus
UTC	Coordinated Universal Time
VDOP	Vertical DOP
VPL	Vertical Protection Level
VRS	Virtual Reference Station
WAAS	Wide Area Augmentation System
WGS84	World Geodetic System 1984
WN	Week Number
WNc	Week number
XERL	External Reliability Levels
XOR	Exclusive OR

Chapter 1

How To...

This chapter contains step-by-step instructions to help you with typical tasks. It will help you to familiarize yourself with the receiver commands without going into too much detail.

For a comprehensive description of the command set, refer to chapter 3. You can also click on any command or SBF block name in this manual to be redirected to the full description of that command or SBF block.

You can enter user commands in many different ways:

- Commands can be accessed graphically through menus in RxControl and in the web interface (see section 1.1.4).
- Using the Data Link program provided in the RxTools suite (or any suitable terminal emulation program), you can enter commands manually through one of the receiver input ports (see section 1.1). In this chapter, user commands are referred to by their full name for readability. When typing the command, you can always use the short mnemonic equivalent to save typing effort. For instance, instead of typing **setCOMSettings**, you can type **scs**.
- You can type commands or mnemonics in the console window of RxControl (menu *Tools > Expert Console*) or of the web interface (menu *Admin > Expert Console*).



Depending on the capabilities of your particular receiver (see section 1.23), some of the user commands, SBF blocks or communication interfaces described in this document may not be supported.

1.1 Connect to the Receiver

1.1.1 Via COM Ports

A simple way to communicate with the receiver is to connect one of its COM-ports to a COM-port of your host computer. You can use the provided COM cable for this purpose. The default COM-port settings are:

Parameter	Value
baud rate	115200
data bits	8
parity	no
stop bits	1
flow control	none

The baud rate can be modified at any time by using the **setCOMSettings** command.

RxControl and Data Link can communicate with the receiver over a COM-port connection: select *Serial Connection* option when opening the connection to the receiver.

1.1.2 Via USB

The Windows USB driver provided with your receiver emulates two virtual serial ports, which can be used as standard COM ports to access the receiver. The Windows USB driver can be installed through the RxTools software suite. On Linux, the standard Linux CDC-ACM driver is suitable. Most terminal emulation programs will make no distinction between virtual and native COM ports. Note that the port settings (baud rate, etc) for virtual serial ports are not relevant, and can be left in their default configuration in the terminal emulation program.

1.1.3 Via a TCP/IP Port

TCP/IP connections allow remote control of the receiver and are potentially much faster than serial connections. Up to eight independent TCP/IP connections can be opened in parallel through port 28784 (the port number can be changed with the command **setIPPortSettings**).

RxControl and Data Link can communicate with remote receivers over a TCP/IP connection: select *TCP/IP Connection* option when opening the connection to the receiver.

TCP/IP connections can be made over the following interfaces.

1.1.3.1 Ethernet

Over the Ethernet interface, the receiver can be configured for dynamic or fixed IP address allocation. The default is dynamic address allocation, using the DHCP protocol. The host-

name is `mosaic-x5-xxxxxxx`, where `xxxxxxx` consists of the last seven digits of the serial number of the receiver.

Dynamic IP address allocation requires the availability of a DHCP server in your local network. In the absence of a DHCP server, or when a fixed IP address is desirable, it is possible to disable the DHCP client and use a fixed address. This is done using the **setIPSettings** command.

1.1.3.2 Ethernet-over-USB

When an USB cable is connected, the receiver supports Ethernet-over-USB. The IP address allocated to the Ethernet-over-USB interface is `192.168.3.1`. That address cannot be changed, so that this feature is only to be used when a single receiver is connected to your computer.

1.1.3.3 Point-to-Point Link

The receiver incorporates a point-to-point protocol server, by which it can accept TCP/IP connections over a serial link.

Configuring the point-to-point server is done with the **setPointToPoint** command. For example, to set up a point-to-point communication over COM1, with the server (i.e. the receiver) having address `192.168.60.1` and the client having address `192.168.60.2`, and using CHAP authentication with password "mypwd", use this command:

```
setPointToPoint, P2PP1, Server, COM1, 192.168.60.2, 192.168.60.1, CHAP, mypwd <CR>
```

If the client is a Linux computer, make sure the password is set in the `/etc/ppp/chap-secrets` file. For example, the contents of that file could be as follows:

```
# Secrets for authentication using CHAP
# client      server  secret          IP addresses
*             *      mypwd          192.168.60.1
```

Assuming that the serial cable is connected to the first serial port of your PC, and that the receiver's COM1 port is left in its default configuration (115200 baud and no hardware flow control), the client PPP daemon can be started with the following Linux command:

```
pppd /dev/ttyS0 115200 nocrtscts local
```

After a few seconds, the PPP link is established and it is possible to access the receiver at IP address `192.168.60.1`.

1.1.4 Via a Web Browser

The receiver can be controlled and configured using a web browser. The hostname or fixed IP address is defined as explained in section 1.1.3.

For example, if your receiver's hostname is `mosaic-x5-1234567`, simply use the following URL in your preferred web browser:

`http://mosaic-x5-1234567`

or, for a secure connection:

`https://mosaic-x5-1234567`

The `https` certificate (`.pem` file) can be uploaded through the *Communication > Web Server/TLS* menu of the web interface.

Most user commands described in section 3.2 can be accessed graphically from the web interface. You can also go to *Admin > Expert Control > Expert Console* to manually type ASCII commands and view replies.

By default, the web interface provides unrestricted read and write access to the receiver. This can be changed, as further explained in section 1.21 of this document.

Note that a lightweight (text only) version of the web interface is available by appending `/lite` to the URL, for example:

`http://mosaic-x5-1234567/lite`

1.1.5 Connection Descriptors

Receiver connections are identified by their connection descriptor (CD). The different connection descriptors are shown in the table below. The three rightmost columns indicate the direction (input or output or both), and whether the connection can accept user command input.

CD	Description	In	Out	Cmd
COMx	one of the serial ports	•	•	•
USBx	one of the USB-device serial ports	•	•	•
DSK1	the internal disk. See section 1.13		•	
IP1x	one of the TCP/IP connections	•	•	•
NTRx	one of the NTRIP connections. Input in NTRIP client mode (section 1.9), output in NTRIP server mode (section 1.8)	•	•	
IPSx	one of the IP server connections. See section 1.11	•	•	•
IPRx	one of the IP receive connections. See section 1.12	•	•	•

1.2 Understand the Output of the Receiver

The receiver outputs proprietary and standardized messages. Each proprietary message begins with a two-character identifier, which identifies the message type.

Proprietary messages	First two characters
ASCII command replies and command error notification	\$R
ASCII transmissions (e.g. periodic output of the status screen), terminated by a prompt. Two sub-types are defined: <ul style="list-style-type: none"> • \$TD : ASCII display generated by the receiver; • \$TE : event notification (e.g. receiver is shutting down). 	\$T
Formatted information blocks (e.g. formal command description)	\$-
SNMP' binary command replies (Septentrio proprietary)	\$&
Proprietary binary data (SBF)	\$@

1.2.1 Proprietary Binary Output (SBF)

The binary messages conform to the SBF definition. The data are arranged in SBF blocks identified by block IDs. All the blocks begin with the SBF identifier \$@. Please refer to section 4 for a description of the SBF format.

The benefit of SBF is completeness. This format should be your first choice if you wish to receive detailed information from the receiver.

The list of supported SBF messages can be found in appendix B

SBF Converter, provided in the RxTools package is an intuitive GUI which allows SBF conversion into e.g. RINEX, KML, GPX or ASCII.

1.2.2 NMEA

The receiver can generate a set of approved NMEA sentences, which conform to the NMEA Standard (version 3.01⁽¹⁾ and version 4.10⁽²⁾ are supported). The benefit of the NMEA format is that it is standardized. Many electronic devices and software packages support NMEA. The drawback of NMEA is a relatively low level of detail.

NMEA output is configured with the **setNMEAOutput** command, and the NMEA version (3.01 or 4.10) is selected with the **setNMEAVersion** command.

The list of supported NMEA sentences can be found in appendix C.

⁽¹⁾ NMEA 0183, Standard for Interfacing Marine Electronic Devices, Version 3.01, National Marine Electronics Association, 2002

⁽²⁾ NMEA 0183, Standard for Interfacing Marine Electronic Devices, Version 4.10, National Marine Electronics Association, 2012

1.2.3 RTCM and CMR

The receiver can operate as DGPS and/or RTK base station and output the corresponding RTCM or CMR messages. The instructions to set the receiver in base station mode can be found in section 1.5.

The list of supported RTCM and CMR messages can be found in appendix D.

1.3 Define an SBF Output Stream

As an example, this section explains how to use the command line interface to configure the receiver to output the `MeasEpoch` SBF block at 10 Hz, the `PVTCartesian` SBF block at 1 Hz, and the `GPSNav` block at its On-Change rate (see section 4.1.8 for more details on the SBF output rate). In this example, we will assume that these blocks must be output through the USB2 connection.

1. First make sure that the USB2 connection is configured for SBF output (this is the default). In case this is not so, you should invoke:

```
setDataInOut, USB2, , +SBF <CR>
```

2. Scheduling SBF blocks for output is done by defining so-called "SBF streams". At least 10 SBF streams can be defined by the user. A stream consists of a set of SBF blocks that need to be output at a given rate through a given connection. By default, all streams are empty, and no SBF blocks are output. For our example, we will need to use two streams. Defining these SBF streams involves the `setSBFOutput` command:

```
setSBFOutput, Stream1, USB2, MeasEpoch+GPSNav, msec100 <CR>
```

```
setSBFOutput, Stream2, USB2, PVTCartesian, sec1 <CR>
```

Note that the rate specified with the `setSBFOutput` command (`msec100` or `sec1` above) only applies to the blocks that support a flexible output rate (see appendix B). The `GPSNav` block does not support flexible rate: it is always output at its "On-Change" rate regardless of the stream rate. For this reason, in the above example, we could equally have enabled `GPSNav` in `Stream2`.

3. To stop outputting SBF on a given connection, you can either redefine or empty the corresponding streams:

```
setSBFOutput, Stream1, USB2, none <CR>
```

```
setSBFOutput, Stream2, USB2, none <CR>
```

A second possibility is to disable all SBF messages on that connection:

```
setDataInOut, USB2, , -SBF <CR>
```

Note that the `exeSBFOnce` command can be used to output a set of blocks once, instead of at regular interval. This is typically used to output all currently available satellite ephemerides at once. For example, the following command instructs the receiver to output all known GPS, GLONASS, Galileo and BeiDou ephemerides over USB2:

```
exeSBFOnce, USB2, GPS+GLO+GAL+BDS <CR>
```

This is a one-time action: the requested blocks are inserted in the stream, and then the normal flow of blocks as defined with `setSBFOutput` resumes. When logging the SBF stream for post-processing, it is a good practice to request all satellite ephemerides with the `exeSBFOnce` command when starting a new log file. Make sure however not to request measurement or PVT blocks with `exeSBFOnce` when these blocks are also enabled with `setSBFOutput` as it could cause the same epoch to be duplicated in the log file. Some post-processing tools may not work properly when the same epoch is repeated twice.

1.4 Save the Configuration in Non-Volatile Memory

The receiver configuration includes all the user-selectable parameters, such as the elevation mask, the PVT mode, the COM port settings,...

By default, the receiver starts up in its factory default configuration. The factory defaults for each of the receiver parameters are underlined for each argument of each command in section 3.2

The current receiver configuration can be checked with the **lstConfigFile** command:
lstConfigFile, Current <CR>

At any time, it is possible to save the current configuration into non-volatile memory, in order to force the receiver to always start up in that configuration. To do so, the following command should be entered:

exeCopyConfigFile, Current, Boot <CR>

To revert to the default setting where the receiver starts in the default configuration, you should use:

exeCopyConfigFile, RxDefault, Boot <CR>

1.5 Configure the Receiver in DGPS/RTK-Base Mode

The receiver can generate and output DGPS and/or RTK corrections in the RTCM and CMR formats. The list of supported RTCM and CMR messages can be found in appendix D.

1.5.1 Static Base Station Mode

To configure the receiver in static base station mode, the following has to be done:

1. For accurate and repetitive absolute positioning, you must provide the accurate coordinates of the antenna reference point (ARP). The ARP usually corresponds to the center of the bottom of the antenna (see also section 2.5). For example, assuming the WGS84 position of the ARP is 50.5°N, 4°E and its altitude above the WGS84 ellipsoid is 100m, use:

```
setStaticPosGeodetic,Geodetic1,50.5,4,100 <CR>  
setPVTMode,Static,,Geodetic1 <CR>
```

If you are only interested in accurate determination of the base-rover baseline, with the absolute position of the rover being of lesser importance, accurate positioning of the base station is not required, and you may simply let the receiver determine its fixed position autonomously ("auto-base" mode), by typing:

```
setPVTMode,Static,,auto <CR>
```

2. For RTCM 3.x, the antenna information in message types 1007, 1008 and 1033 can be specified using the **setAntennaOffset** command, with the serial number as sixth argument, and the antenna type (called "antenna descriptor" in RTCM) as fifth argument (see also section 2.5). For instance:

```
setAntennaOffset,Main,,,,,"AT2775-54SW","5684" <CR>
```

3. Use the commands **setRTCMv2Interval**, **setRTCMv2IntervalObs**, **setRTCMv3Interval** or **setCMRv2Interval** to specify the message interval (default is one second for most messages). For instance, to change the interval at which RTCM 3.x message type 1033 is generated to 10 seconds, type:

```
setRTCMv3Interval,RTCM1033,10 <CR>
```

4. Use the commands **setRTCMv2Formatting**, **setRTCMv3Formatting** or **setCMRv2Formatting** to specify the base station ID. If you are setting up multiple base stations, make sure to select a unique ID for each of them. For instance:

```
setRTCMv3Formatting,496 <CR>
```

5. By default, the receiver is configured to output all RTCM and CMR messages necessary for DGPS and RTK operation. If necessary, the set of output messages can be specified with the commands **setRTCMv2Output**, **setRTCMv3Output** or **setCMRv2Output**. For instance, to output RTCM3.x messages 1006, 1033 and 1074 on COM2, use:

```
setRTCMv3Output,COM2,RTCM1006+RTCM1033+RTCM1074 <CR>
```

If you are using the RTCM3.x MSM messages (see appendix D), you can use the **setRTCMv3Formatting** command to configure the signal types that need to be

encoded in MSM.

- The RTCM stream can be output through any output connection listed in section 1.1.5. For instance, to enable RTCM 3.x output through COM2, use:

```
setDataInOut, COM2, , RTCMv3 <CR>
```

- When sending differential corrections over a serial port, do not forget to specify the baud rate. For instance if the differential correction stream needs to be output on COM2 at 9600 baud, use:

```
setCOMSettings, COM2, baud9600 <CR>
```

To stop transmitting RTCM messages, enter the following command:

```
setDataInOut, COM2, , none <CR>
```

Note that, even in static mode, the receiver computes a PVT solution to estimate the clock bias.

1.5.2 RTK Moving Base Station Mode

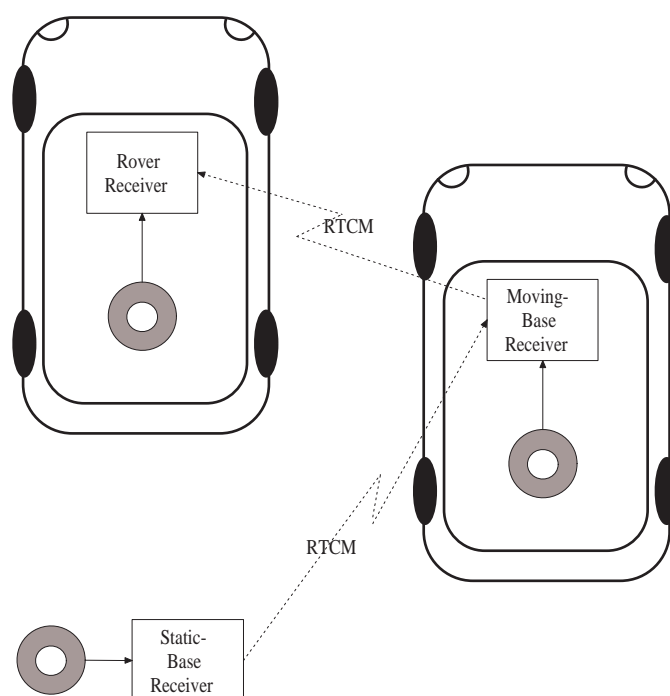

Figure 1-2: Example of a RTK moving-base configuration where the moving base receives RTCM corrections from a static base and transmits RTCM corrections to the rover.

To configure the receiver in RTK moving base, follow the steps below:

- The PVT engine must be set in one of the rover modes (standalone, DGPS, SBAS, RTK). The type of the PVT mode at the moving base station will determine the absolute position accuracy of the RTK rover receiver. On the other hand, the accuracy of the relative position of the rover with respect to the moving base is not influenced by the

PVT mode at the moving base station.

For instance, to let the moving base station compute a simple standalone PVT, use the following:

```
setPVTMode, Rover, StandAlone <CR>
```

If accurate absolute and relative positioning of the rover is required, the moving base can operate in RTK-rover positioning mode and receive RTCM or CMR corrections from a static base station, as illustrated in Figure 1-2. Refer to section 1.6 to configure the moving-base receiver in RTK-rover mode.

2. From now on, follow the same procedure as for a static base station, starting at step 2 of section 1.5.1 and taking into account the following recommendations:
 - RTCM v2.x and CMR are not recommended for moving-base applications, always use RTCM v3.x in the link between the moving base and the rover.
 - To decrease the effect of extrapolation errors, use a short RTCM or CMR message interval (see the commands **setRTCMv3Interval** and **setCMRv2Interval**). In most cases, it is safe to set the interval to its minimum value of 0.1 seconds. If the RTCM or CMR messages are sent through a COM connection, make sure that the baud rate is sufficient to support the high rate. A value of 115200baud is typical.
 - In moving base, it is recommended to send the base position and observables at the same rate.

See also section 2.4.3.3 for more details on moving-base operation.

1.6 Configure the Receiver in DGPS/RTK-Rover Mode

The receiver computes a DGPS and/or an RTK solution when it receives the relevant differential correction messages on one of its connections. The list of supported differential correction messages can be found in appendix D.

To configure the receiver in DGPS/RTK-rover mode, the following has to be done:

1. Make sure that at least one of the receiver connections is receiving differential corrections. Any input connection listed in section 1.1.5 is suitable. When using a serial connection, make sure to configure the baud rate to match the baud rate of the incoming RTCM stream. For instance if the incoming RTCM stream is received through COM2 at a baud rate of 9600 baud, use:

```
setCOMSettings,COM2,baud9600 <CR>
```

2. By default, the receiver assumes that the base station is static. If it is moving, enter the following command:

```
setDiffCorrUsage,,,,,on <CR>
```



In DGPS-rover mode, the base station must be static. Moving base stations are only supported in RTK-rover mode.

3. The receiver automatically detects the format of the differential corrections (RTCM or CMR) and switches between standalone, DGPS or RTK modes according to the type of corrections it receives, provided these modes are enabled with the **setPVTMode** command (all modes are enabled by default).

Refer to sections 2.4.2 and 2.4.3 for further details on the DGPS and RTK positioning mode.

1.7 Determine a GNSS-Based Attitude from a Moving Base

The heading and pitch of a vehicle can be derived from the orientation of the baseline between a base and a rover antenna when both antennas are attached to the vehicle. The base antenna is connected to a first receiver configured as RTK moving base station. The rover antenna is connected to a second receiver configured as RTK rover and accepting the RTCM stream from the first receiver. This is illustrated in Figure 1-3.

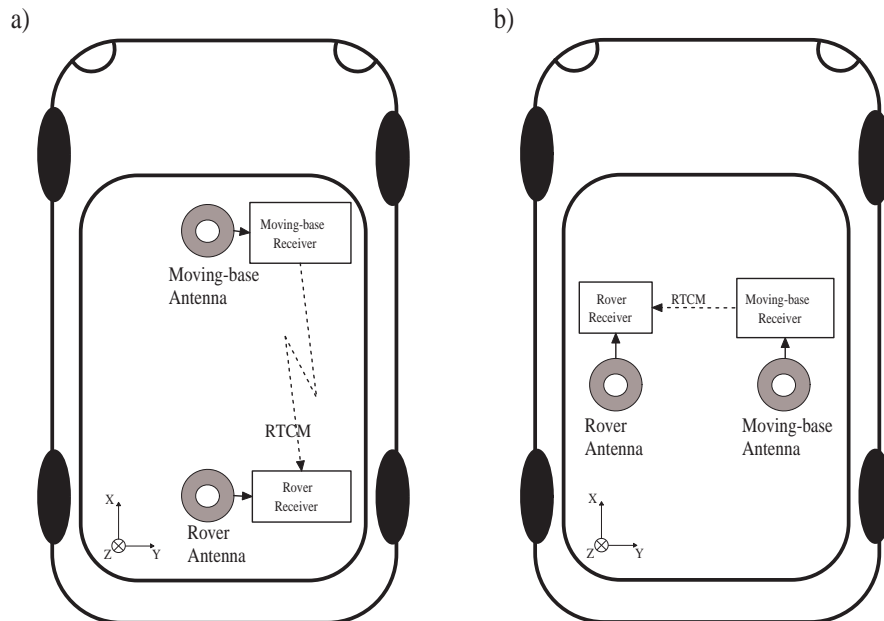

Figure 1-3: Moving-base attitude determination setup. a) default configuration. b) example of non-default configuration.

To enable moving-base attitude determination, follow the following procedure:

1. Attach two antennas to your vehicle. The default antenna configuration is as depicted in Figure 1-3 a). It consists in placing the antennas aligned with the longitudinal axis of the vehicle. If such configuration is not possible, you will have to provide additional information to the receiver, as explained below. For best accuracy, try to maximize the distance between the antennas, and avoid significant height difference between them.
2. Connect one of the antennas (preferably the one at the front of the vehicle) to the receiver that will serve as moving base. Connect the other to the receiver that will serve as rover. That latter receiver is the one where the heading and pitch will be computed.
3. Configure the moving-base receiver to send RTCM 3.x corrections to the rover. The procedure to do so is explained in section 1.5.2.
4. Configure the rover receiver to accept the RTCM corrections from the moving base, by following the steps in section 1.6.
5. By default, the attitude angles are computed assuming that the two antennas are aligned with the longitudinal axis of the vehicle, and that the moving-base antenna

is in front of the rover antenna (see Figure 1-3 a)). If you cannot place the antennas in such configuration, the reported attitude angles will be biased. There are two ways to remove these biases:

- (a) The biases can be removed by telling the receiver where the moving-base antenna is located in the vehicle reference frame (see appendix A). This is done by specifying the coordinates of the baseline between the rover antenna reference point (ARP) and the moving-base ARP in the X, Y and Z directions. For example, in the configuration b) of Figure 1-3, assuming that the distance between the antenna ARPs is 1 meter, you would issue (on the rover receiver):

```
setAntennaLocation, Base, manual, 0, 1, 0 <CR>
```

- (b) Another way to remove the biases is to provide them to the receiver. For example, if the heading and pitch angles reported by the receiver have an offset of respectively 10 and 12 degrees with respect to their expected value, you can have the receiver compensate for that offset by using the following command:

```
setAttitudeOffset, 10, 12 <CR>
```

6. Specify that the attitude has to be computed in moving-base mode by issuing the following command in the rover receiver:

```
setGNSSAttitude, MovingBase <CR>
```

The attitude angles are available from the rover receiver in the `AttEuler` SBF block or in the HDT and HRP NMEA sentences.

1.8 Configure the Receiver in NTRIP Server Mode

In the example below, we show how to configure the receiver to send RTCM 3.x corrections to an NTRIP caster using the following parameters:

- NTRIP caster hostname: ntrip.example.com
 - NTRIP caster port: 2101
 - User name/password for basic authentication: USER / PASSWD
 - Mount Point: LEUV1
 - TLS: enabled and the caster is trusted by a public certification authority
1. Configure one of the NTRIP connections (see section 1.1.5) in server mode for sending data to the NTRIP caster. Here, we assume that the first NTRIP connection (NTR1) is free and can be used for that purpose:
setNTRIPSettings, NTR1, Server, ntrip.example.com, 2101, USER, PASSWD, LEUV1 <CR>
 2. To enable TLS for NTR1, use:
setNtripTlsSettings, NTR1, on, "" <CR>
 3. By default, for RTCM 3.x, the receiver is configured to send message types 1004, 1006, 1012 and 1033 at an interval of one second. This can be changed by using the **setRTCMv3Output** and **setRTCMv3Interval** commands. For instance, to change the interval of RTCM1033 to 10 seconds, use:
setRTCMv3Interval, RTCM1033, 10 <CR>
 4. Enable the output of RTCM 3.x corrections on the NTR1 connection:
setDataInOut, NTR1, , RTCMv3 <CR>
 5. Closing the NTRIP connection is done with the following command:
setNTRIPSettings, NTR1, off <CR>

See also section 1.5 for more information on configuring the receiver as a base station.

The NTRIP server can also send data to the built-in caster, by specifying "localhost" as host-name. Refer to section 1.10 for details.

1.9 Configure the Receiver in NTRIP Client Mode

In this section, we show how to configure the receiver to receive and use RTK corrections from an NTRIP caster. In the example below, the NTRIP caster and Mount Point details are as follows:

- NTRIP caster hostname: ntrip.example.com
 - NTRIP caster port: 2101
 - User name/password for basic authentication: USER / PASSWD
 - Mount Point: LEUV1
 - TLS: enabled and the caster is trusted by a public certification authority
1. Configure one of the NTRIP connections (see section 1.1.5) for communication with the NTRIP caster in client mode. Here, we assume that the first NTRIP connection (NTR1) is free and can be used for that purpose:
setNTRIPSettings,NTR1,Client,ntrip.example.com,2101,USER,PASSWD,LEUV1 <CR>
 2. To enable TLS for NTR1, use:
setNtripTlsSettings,NTR1,on,"" <CR>
 3. The receiver will automatically receive and decode the RTK corrections from the NTRIP caster and switch to RTK positioning mode, unless RTK is disabled with the **setPVTMode** command.
 4. Closing the NTRIP connection is done with the following command:
setNTRIPSettings,NTR1,off <CR>

The status of the NTRIP client connection is reported in the `NTRIPClientStatus` SBF block.

1.10 Use the Built-In NTRIP Caster

The receiver contains an NTRIP caster, which is able to broadcast local data streams originating from the receiver itself, or streams from any remote NTRIP server. The hostname or IP address of the built-in caster is as defined in section 1.1.3.

1.10.1 Broadcasting Local Streams

This section explains how to use the built-in NTRIP caster to broadcast a local stream generated by the receiver's own NTRIP server.

1. Define the mount point you want to use for streaming the data. For example, the following command enables the first mount point, gives it the name "MyMP", and specify that this mount point only accepts local streams:

```
setNtripCasterMountPoints, MP1, on, MyMP, No <CR>
```

2. Define the data format. For example, if the mount point defined above is meant to stream RTCM v3.x corrections, use the following command:

```
setNtripCasterMPFormat, MP1, RTCMv3 <CR>
```

3. Define the NTRIP client accounts. For example, the command below enables an NTRIP client connecting as user "u1" and with password "p1" to receive data from the first mount point:

```
setNtripCasterUsers, User1, u1, p1, MP1 <CR>
```

4. Configure the local NTRIP server to send data to the mount point, as explained in section 1.8. To have the local NTRIP server send data to the built-in caster, the hostname has to be set to "localhost". For example, to send data to the mount point "MyMP" of the caster, use:

```
setNTRIPSettings, NTR1, Server, localhost, , , , MyMP <CR>
```

5. Enable the built-in NTRIP caster:

```
setNtripCasterSettings, on <CR>
```

1.10.2 Broadcasting Remote Streams

To configure the caster to broadcast a stream originating from a remote NTRIP server, follow the following steps.

1. Define the mount point. For example, the following command enables the first mount point, gives it the name "MyMP", and specifies the credentials that the remote NTRIP server will need to use in order to feed data to this mount point ("FeedUser" and "FeedPwd"):

```
setNtripCasterMountPoints, MP1, on, MyMP, Yes, FeedUser, FeedPwd <CR>
```

2. Define the stream data format. For example, if the mount point defined above is meant to stream RTCM v3.x corrections, use the following command:

```
setNtripCasterMPFormat, MP1, RTCMv3 <CR>
```

3. Define the NTRIP client accounts. Up to five client accounts can be configured. For example, the command below enables an NTRIP client connecting as user "u1" and with password "p1" to receive data from the first mount point:

```
setNtripCasterUsers, User1, u1, p1, MP1 <CR>
```

4. Enable the built-in NTRIP caster:

```
setNtripCasterSettings, on <CR>
```

From now on, the NTRIP caster is ready to receive a data stream from a remote NTRIP server and to distribute it to NTRIP clients.

1.11 Configure an IP Server Port

In this example, we show how to configure the receiver such that any client connecting to TCP/IP port 28785 will receive the NMEA GGA message at a 1-second interval.

1. Configure one of the IP server connections (see section 1.1.5) to listen to port 28785. Here, we assume that the first IP server connection (`IPS1`) is free:
setIPServerSettings, IPS1, 28785, TCP <CR>
2. Output the GGA NMEA message to the `IPS1` connection, at a 1-Hz rate:
setNMEAOutput, Stream1, IPS1, GGA, sec1 <CR>
3. Make sure that NMEA output is enabled on the `IPS1` connection. It is enabled by default, but in case your receiver is not in its default configuration, you should invoke:
setDataInOut, IPS1, , +NMEA <CR>

A way to check the IP server functionality is to enter the URL **http://mosaic-x5-xxxxxxx:28785** in your preferred web browser (replace `mosaic-x5-xxxxxxx` by the hostname of your particular receiver). You should see the NMEA GGA message coming every second.

Note that up to eight clients can concurrently connect to the same IP server port.

The example above showed how to set up a TCP server. It is also possible to configure the receiver in UDP server mode. For example, to broadcast the GGA message to any UDP client listening to its port 28785, the command in step 1. above must be replaced by:

setIPServerSettings, IPS1, 28785, UDP, 255.255.255.255 <CR>

Conversely, the receiver can be configured to automatically receive data from an IP server. This is explained in section 1.12.

1.12 Configure an IP Receive Port

The receiver can be configured to automatically receive data (typically differential corrections) from an IP server. In this example, we show how to connect to an IP server having the hostname `MyServer` and using port 28786.

1. Configure one of the IP receive connections (see section 1.1.5) to listen to port 28786 of `MyServer`. Here, we assume that the first IP receive connection (`IPR1`) is free:
`setIPReceiveSettings, IPR1, 28786, TCP2Way, MyServer <CR>`
2. If the data stream from the IP server contains differential corrections in CMR or RTCM format, the receiver will automatically decode them and use them in the PVT processing.
3. To close the connection, enter the following command:
`setIPReceiveSettings, IPR1, 0 <CR>`

The TCP connection initiated by the receiver is bidirectional. Once the connection is established, the receiver accepts input data from the server (as shown above), but it can also send data to the server, or process user commands from the server.

The example showed how to set up a TCP connection with the server. The receiver can also listen to incoming UDP messages. In that case, the connection is unidirectional and the server address or hostname must not be specified. For example, to listen to UDP messages on port 28786, use the command:

`setIPReceiveSettings, IPR1, 28786, UDP <CR>`

1.13 Log SBF or NMEA

The connection descriptor (see section 1.1.5) associated to the internal disk is "DSK1". Enabling SBF or NMEA logging on the internal disk involves the following steps:

1. By default, the receiver logs SBF blocks into a file named "log.sbf" and NMEA sentences into a file named "log.nma". You can specify any other fixed or auto-incrementing file name, or you can select the IGS/RINEX naming convention, where the file name automatically changes every fifteen minutes, hour, six hours or day. For instance, to let the receiver create daily files, use:

```
setFileNaming,DSK1,IGS24H <CR>
```

If the file name you selected already exists, the receiver will append new data at the end of the existing file.

2. Use the command **setSBFOutput** to define which SBF blocks need to be logged (for NMEA, use **setNMEAOutput** instead), and at which interval (see also section 1.3). For instance, to log all SBF blocks necessary to build RINEX files, with the measurements and positions being output at a 10-s interval, use:

```
setSBFOutput,Stream1,DSK1,rinex,sec10 <CR>
```

3. Start the logging by enabling SBF and NMEA output to the DSK1 connection (it is enabled by default):

```
setDataInOut,DSK1, ,+SBF+NMEA <CR>
```

4. Once the logging session is finished, stop the logging by invoking:

```
setDataInOut,DSK1, ,-SBF-NMEA <CR>
```

Refer to section 1.15 to learn how to download the logged files.

1.14 Log RINEX Files

The receiver can log RINEX observation and navigation files on its internal disk. RINEX v2.11 and 3.04 are supported.

Internal RINEX logging is typically configured as follows:

1. The RINEX file names follow the RINEX 2.11 naming convention (*ssssddd.f.yyt*), with the 4-character station name designator (*ssss*) being the first four characters of the station code as specified with the **setMarkerParameters** command. For example, to set the station name designator to "LEUV", use:

```
setMarkerParameters, , , , LEUV <CR>
```

2. The fields in the RINEX observation header are specified with the **setMarkerParameters**, **setObserverParameters** and **setAntennaOffset** commands. For example, if the observer's name is "MyName" and its agency is "MyAgency", use the command:

```
setObserverParameters, MyName, MyAgency <CR>
```

3. The reference marker position to put in the "APPROX POSITION XYZ" header line is defined with the *RefPos* argument of **setPVTMode**, with the marker-to-ARP offset being defined with **setAntennaOffset**. For example, assuming the WGS84 position of the ARP is 50.5°N, 4°E and its altitude above the WGS84 ellipsoid is 100m, and the ARP is 1.5 meters above the marker, use:

```
setStaticPosGeodetic, Geodetic1, 50.5, 4, 100 <CR>
```

```
setPVTMode, , , Geodetic1 <CR>
```

```
setAntennaOffset, Main, 0, 0, 1.5 <CR>
```

4. Use the **setRINEXLogging** command to specify the file duration (fifteen minutes, one hour, six hours or one day), the observation interval and the type of observables to include in the RINEX file. For example, to generate daily RINEX files with the observation file containing only GPS L1CA data at a 30-s interval, use:

```
setRINEXLogging, DSK1, Hour24, sec30, GPSL1CA <CR>
```

In this command, *DSK1* refers to the internal disk.

5. The command **setDiskFullAction** specifies what to do when the internal disk becomes full. For example, you could ask the receiver to automatically delete the oldest file to free up disk space. To do so, use:

```
setDiskFullAction, DeleteOldest <CR>
```

Instead of logging RINEX files inside the receiver, you can also convert an SBF file to RINEX using the *sbf2rin* program or the *SBFConverter* graphical tool.

1.15 Download Log Files from the Receiver

There are different ways to download or delete files from the internal disk:

1. Using RxControl. Select *Logging > Download Internal Files* to download files to your computer, and *Logging > Remove Internal File* to remove a file from the internal disk.

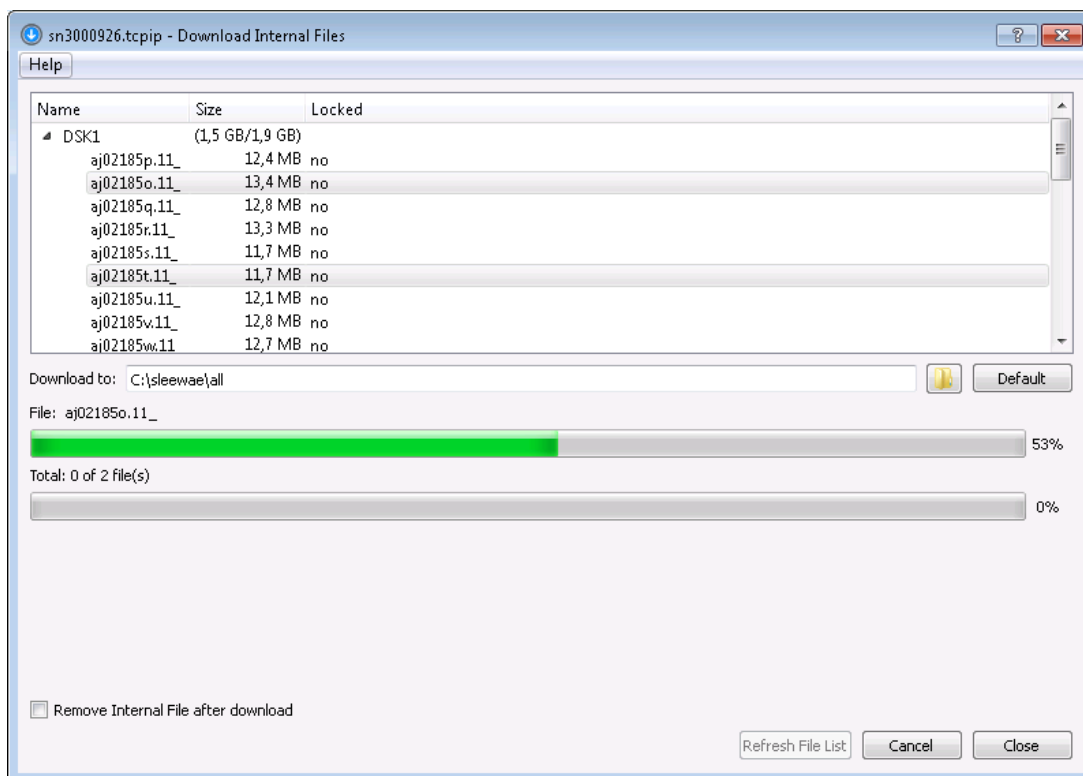

Figure 1-4: Download Internal Files from RxControl.

2. Using FTP or SFTP. The hostname or fixed IP address is defined as explained in section 1.1.3. For example, if your receiver's hostname is `mosaic-x5-1234567`, you can type the following URL in your preferred web browser to open a session as anonymous user:

ftp://mosaic-x5-1234567

User authentication for SFTP access can be done by entering a password or using an ssh public key, as defined with the `setUserAccessLevel` command.

By default, anonymous users can download and delete files. This can be changed as explained in section 1.21.

3. Using `rsync`. If an `rsync` client is available on your computer, you can use `rsync` to download files or directories from the receiver. The hostname or IP address is the same as for (S)FTP, see above.

For example, to download the contents of the `log.sbf` file of the internal disk (DSK1) to the current folder on your local computer, you could invoke `rsync` as follows:

`rsync -r anonymous@mosaic-x5-1234567:DSK1/SSN/GRB0051/log.sbf .`
when prompted for a password, just press the enter key as no password is required for

anonymous accesses.

If the same command is issued again at a later stage, `rsync` will only transfer the deltas with respect to the files already present on the local machine, significantly reducing the number of bytes sent compared to retransmitting the entire files.

User authentication can be done by entering a password, or using an ssh public key, as defined with the **`setUserAccessLevel`** command.

By default, `rsync` is enabled for anonymous users. This can be changed with the **`setDefaultAccessLevel`** command.

4. Using the web interface (select the *Logging* tab).

1.16 FTP Push Log files

It is possible to configure the receiver to automatically send internally-logged files to a remote FTP server (FTP Push). This is done with the **setFTPPushSBF** and **setFTPPushRINEX** commands respectively.

For example, to automatically FTP RINEX files to the directory `mydata/rin/YYDDD` (with `YY` and `DDD` the year and day-of-year) on the remote server `myftp.com`, with username `myname` and password `mypwd`, you would enter the following command:

```
setFTPPushRINEX, myftp.com, mydata/rin/%y%j, myname, mypwd <CR>
```

To FTP push SBF files to the same location, you would use:

```
setFTPPushSBF, myftp.com, mydata/rin/%y%j, myname, mypwd <CR>
```

FTP push will create the folder on the remote server if it does not exist yet.

1.17 Communicate with External Equipment

The receiver can send periodical queries to external equipment (such as a meteo sensor) connected to one of its serial ports, and log the replies from that sensor. In the following example, we show how to retrieve meteo data every 10 seconds from a meteo sensor connected to the receiver's COM2 port.

1. Tell the receiver which command to use to query the external sensor, and the interval at which this command must be sent to the sensor. For instance, for a MET3/MET4-compatible sensor, the command `*0100P9<CR><LF>` queries the meteo data. Assuming you want to get meteo data at a 10-second interval, enter the following command:

```
setPeriodicEcho, com2, A:*0100P9%%CR%%LF, sec10 <CR>
```

2. Enable unformatted ASCII input on COM2 (to receive the replies from the meteo sensor):

```
setDataInOut, COM2, ASCIIIn <CR>
```

The replies from the meteo sensor (containing the temperature, pressure and humidity) are available in the `ASCIIIn` SBF block.

You can convert an SBF file containing `ASCIIIn` SBF blocks to RINEX using the `sbf2rin` program or the `SBFConverter` graphical tool. To be able to generate a RINEX file, the output of the meteo sensor must be formatted according to the NMEA XDR sentence.

1.18 Generate a "Pulse Per Second" Signal

The receiver is able to generate an x-pulse-per-second (xPPS) signal aligned with either GPS, Galileo or GLONASS system time, or with UTC, or with the internal receiver time.

By default, the PPS is a positive pulse of which the leading edge is synchronous with the second boundaries of the time system selected with the `setTimingSystem` command. Check the Hardware Manual for the voltage and the duration of the pulse.

The command `setPPSPParameters` can be used to synchronize the PPS with UTC, GLONASS or the internal time, or to change the PPS interval and polarity. For instance, to synchronize the PPS with UTC and have one pulse every ten seconds, use:

```
setPPSPParameters,sec10, , ,UTC <CR>
```

When the PPS output is configured to be synchronized with a GNSS system or with UTC, the antenna and cable delays will cause the PPS to be offset from its correct position. The third argument of the `setPPSPParameters` command can be used to specify the overall antenna and cable delay, in order to allow the receiver to compensate for them.

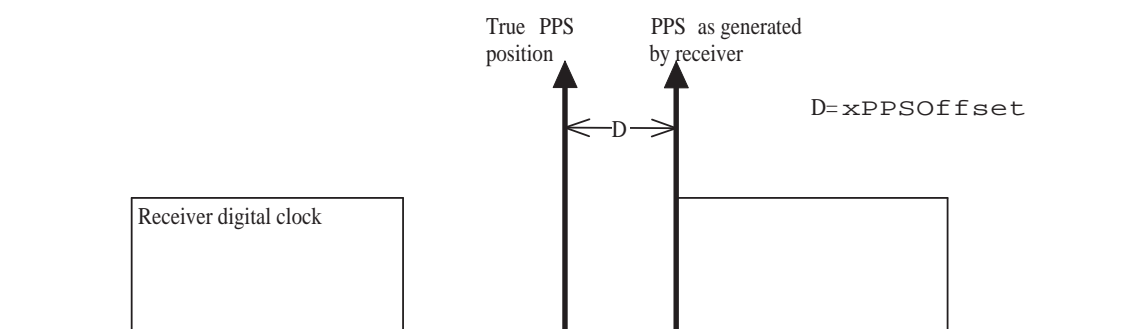

Figure 1-5: xPPS output granularity.

Although the position of the PPS pulse is computed accurately by the receiver, the actual pulse is generated at the nearest "tick" of the internal receiver digital clock, as illustrated in the figure above. This leaves an offset (noted "D" in the figure) between the true xPPS pulse and the one actually generated by the receiver. This offset can reach a few nanoseconds. It is available in real-time in the `xPPSOffset` SBF block.

To be able to align its xPPS output with the GNSS system time, the receiver needs a fresh estimate of the GNSS time from its PVT solution. If the last PVT solution is older than a prescribed timeout (set by the `setPPSPParameters` command), no PPS pulse is generated. In addition, to align its PPS with UTC, the receiver needs to have received the UTC offset parameters from the satellite navigation messages. If these parameters are not available and the user has requested to align the xPPS with UTC, no xPPS pulse is generated.

1.19 Time Tag External Events

The receiver can time-tag electrical level transitions on its EventX inputs with an accuracy of 20ns.

By default, the receiver reacts on low-to-high transitions. You can use the **setEventParameters** command to react on falling edges instead:
setEventParameters,EventA,High2Low <CR>

Upon detection of a transition, the receiver can output the time and/or the position at the instant of the event (see for example the `ExtEvent` SBF block).

The following constraints must be observed to ensure proper event detection:

- There must be no more than 20 events in any interval of 100 milliseconds, all event pins considered.
- The minimum time between two events on the same EventX input must be at least 5ms.

Missed events are flagged by the `MISSEDEVENT` bit in the `ReceiverStatus` SBF block.

1.20 Monitor the RF Spectrum

You can monitor the RF spectrum using the spectral analyzer in RxControl (go to the *View > Spectral View* menu) or in the web interface (go to the *GNSS > Spectrum* menu). This allows to detect the presence of interferences in the GNSS bands.

In the example shown below, a narrowband interference at 1180 MHz is clearly visible.

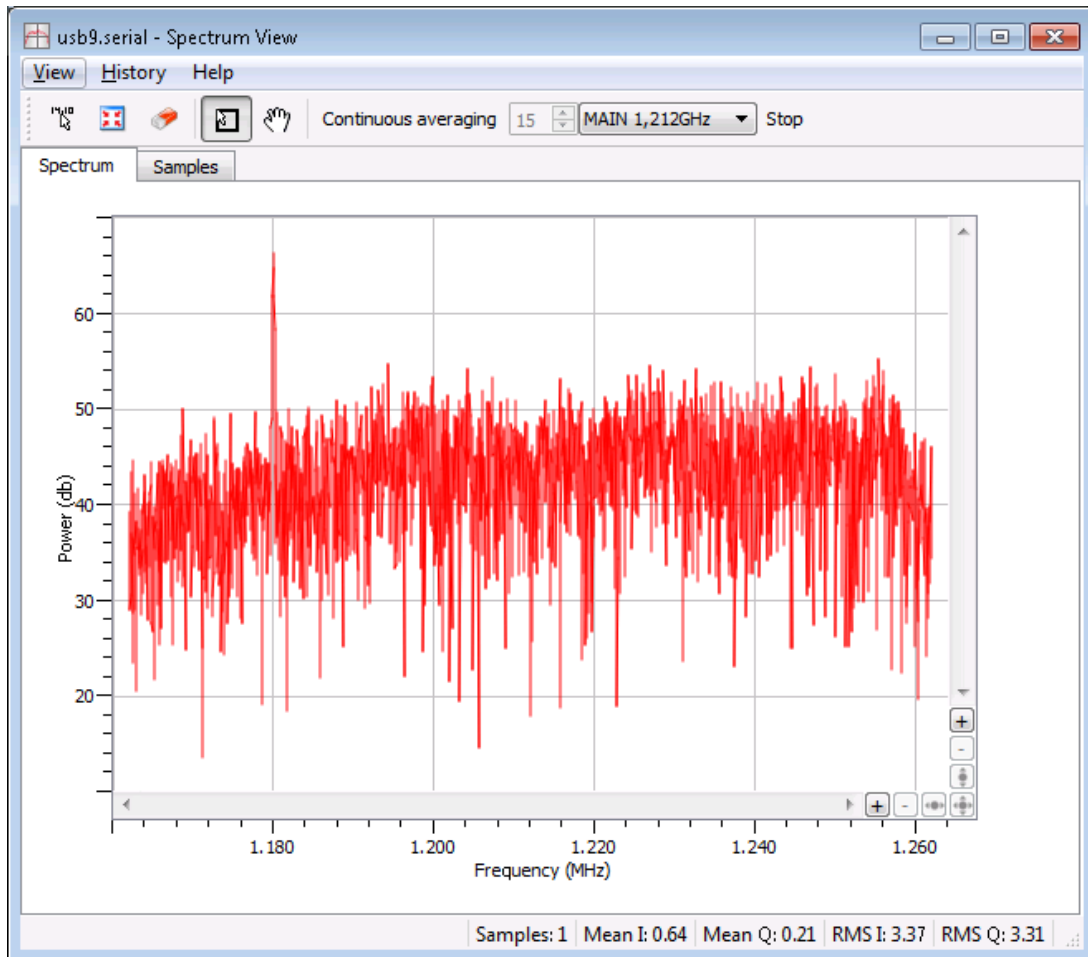

Figure 1-6: Spectral Analyser functionality of RxControl.

The spectrum is computed from baseband samples taken at the output of the receiver's analog to digital converters. These samples are available to the users in the `BBSamples` SBF block.

1.21 Manage Users

When connecting to the receiver, users can remain "anonymous", or can log in using the **login** command. What anonymous users can do depends on the connection type. By default, anonymous users have full control of the receiver. This default configuration can be changed with the **setDefaultAccessLevel** command. For example, to prevent anonymous access to the web interface and to the FTP server, you would use: **setDefaultAccessLevel, none, none <CR>**

To perform actions not allowed to anonymous users, you first need to authenticate yourself by entering a user name and a password through the **login** command. The list of user names and passwords and their respective access level is managed with the **setUserAccessLevel** command. Login fails if the provided user name or password is not in that list.

Logged-in users are granted one of the following access levels: "User" or "Viewer". The "User" level allows full control of the receiver, while the "Viewer" level only allows to view the configuration.

The following explains how to add or delete a user.

1. Check the current user list by entering the following command:

```
getUserAccessLevel <CR>
```

The reply to this command looks like:

```
UserAccessLevel, User1, "admin", "R46NCG", User
UserAccessLevel, User2, "", "", Viewer
UserAccessLevel, User3, "", "", Viewer
...
```

2. In the example shown above, only one user is defined: `User1` with user name `admin`. For security reasons, the password shown here (`R46NCG`) is random and does not correspond to the actual password. It can be seen that the level of access of the `admin` user is "User": that particular user has full control of the receiver.

To add a new user "john" with password "abc123" and to give full access to that user, select a free user index, e.g. `User2` in the above example, and type:

```
setUserAccessLevel, User2, john, abc123, User <CR>
```



3. You can add up to eight users in this way. Deleting a user involves entering an empty string ("") as user name and password. For example, to delete the "admin" user from the above list, use:

```
setUserAccessLevel, User1, "", "" <CR>
```

The user list also applies to FTP, SFTP and `rsync` accesses. Users having the "User" access right are allowed to delete files from the internal disk via FTP, SFTP or `rsync`, while "Viewer" users can only download files.

1.22 Upgrade the Receiver

Upgrading the receiver is the process of installing a new GNSS firmware, a new permission file (see section 1.24) or a new antenna calibration file (see section 2.5).

-  In some cases, upgrading the GNSS firmware can clear the receiver configuration stored in non-volatile memory (see section 1.4). It is therefore advised to recheck the configuration after the upgrade.
-  Do not switch power off during the upgrade procedure.
-  Upgrading the receiver over a serial port can be very slow and it is recommended to upgrade using a faster connection whenever possible (USB or Ethernet).

Septentrio upgrade files have the extension “.suf”. There are several ways to upgrade the receiver:

1. By double clicking the “.suf” file. This should launch the RxUpgrade program.
2. By using the RxControl graphical interface (go to the *File* menu).
3. From the web interface (go to *Admin >Upgrade*). This requires to log in as a user with the "User" access level (see section 1.21).
4. By commanding the receiver to upgrade itself by fetching the upgrade file from a remote FTP server. This is done with the command **exeFTPUpgrade**.
5. By manually downloading upgrade files to the receiver. This upgrade procedure is explained below.

To manually upgrade the receiver, follow this procedure:

1. Reset the receiver into upgrade mode by entering the following command:
exeResetReceiver, Upgrade, none <CR>
2. Wait till the receiver outputs the string: “Ready for SUF download ...”. From that moment on, the receiver is waiting for an upgrade file to be downloaded. The file download must start within 200 seconds, otherwise the receiver will restart in normal mode.
3. Download the upgrade file to the receiver. Any of the receiver connections can be used. Make sure to send the file in binary mode, i.e. without changing its contents. During the download, the receiver outputs a progress indicator at regular interval.
4. At the end of the download, the receiver automatically executes the upgrade instructions and restarts with the new firmware version. You can check the firmware version by entering the following command:
lif, Identification <CR>

Before executing the upgrade instructions, the receiver checks the integrity of the downloaded file. If the file is corrupted, or is not a valid upgrade file, the receiver discards it and restarts in normal mode.

If the download is interrupted for any reason, the receiver will restart in normal mode after a timeout period of 200 seconds.

1.23 Check the Capabilities of your Receiver

The capabilities of your receiver are defined by the set of enabled features. The capabilities depend on the hardware, the current firmware version and the current set of permissions. Permissions are further explained in section 1.24.

The command `getReceiverCapabilities` lists the capabilities. You can also check them using the web interface or RxControl (go to *Help > Receiver Interface* and select the *Permitted Capabilities* tab):

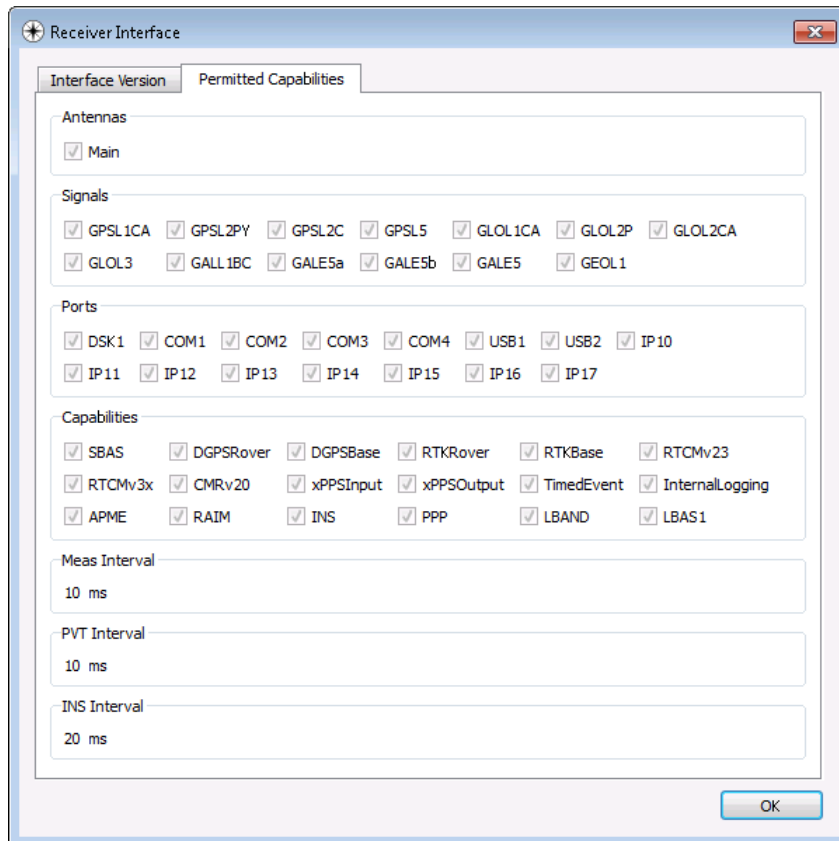

Figure 1-7: Example of receiver capabilities.

1.24 Check or Change the Permission File

The permission file lists which optional features (such as GLONASS, Galileo, RTK, ...) are permitted on your receiver, for how long they are permitted and in which region they are permitted.

The permission file is stored in the receiver's non-volatile memory, and can be checked with the command **lstInternalFile, Permissions**, or with RxControl by clicking *Help > Receiver Permissions*.

Note that, for a given feature to be enabled in the receiver, it must be permitted and the hardware and firmware version must support it. See also section 1.23.

Each receiver is delivered with a permission file applicable to that receiver only. To enable new options, the user can order a new permission file to Septentrio, and install it on his/her receiver using the standard upgrade procedure (see section 1.22).

Chapter 2

Operation Details

This chapter describes the key processes implemented in the receiver and explains how they can be configured.

2.1 Channel Allocation and Signal Selection

The receiver automatically allocates satellites to tracking channels up to the limit of the number of channels. It is possible to override this automatic channel allocation by forcing a satellite to a given channel with the **setChannelAllocation** command. Also, a subset of satellites or a whole constellation can be disabled with the **setSatelliteTracking** command.

For each satellite, the receiver tries to track all signal types enabled with the **setSignalTracking** command. For example, if that command enables the GPSL1CA, GPSL2PY and GLOL1CA signals, GPS satellites will be tracked in dual-frequency mode (GPSL1CA and GPSL2PY) and GLONASS satellites will be tracked in single-frequency mode (GLOL1CA only). It is a good practice to only enable those signal types that are needed for your application to avoid wasting tracking channels.

2.2 Generation of Measurements

For each tracked GNSS signal, the receiver generates a "measurement set", mainly consisting of the following observables:

- a pseudorange in meters;
- a carrier phase in cycles;
- a Doppler in Hertz;
- a carrier-to-noise ratio in dB-Hz.

All data in a measurement set, and all measurement sets are taken at the same time, which is referred to as the "measurement epoch". All the measurement sets taken at a given measurement epoch are output in a `MeasEpoch` SBF block.

Several commands affect the way the receiver produces and outputs measurements:

- The **setHealthMask** command can be used to filter out measurements from unhealthy satellites: these measurements will not be used by the PVT algorithm, nor will they be included in the `MeasEpoch` SBF block.
- To further reduce the code measurement noise, the receiver can be ordered to smooth the pseudorange by the carrier phase. This technique, sometimes referred to as a "Hatch filtering", allows to reduce the pseudorange noise and multipath. It is controlled by the **setSmoothingInterval** command and is disabled by default.
- The **setMultipathMitigation** command can be used to enable or disable the mitigation of multipath errors on the pseudorange and carrier phase measurements. It is enabled by default.

For advanced applications or in-depth signal analysis, the `MeasExtra` SBF block contains various additional data complementing the `MeasEpoch` SBF block. Among other things, this block reports the multipath correction applied to the pseudorange (allowing one to recompute the original pseudorange), and the observable variances.

2.2.1 Pilot vs. Data Component

Most modern GNSS signals consist of two components: a so-called pilot component and a data component. For such signals, the measurements are based on the pilot component for optimal performance. In particular, the reported C/N_0 value is that of the pilot component only.

For all signals having a pilot and a data component, the table below indicates which component is tracked by Septentrio receivers. Note that your particular receiver model may not support all of these signals.

Signal	Signal component being used for measurement generation
GPS/QZSS L1C	L1C-P
GPS/QZSS L2C	L2C-L
GPS/QZSS L5	L5-Q
GLONASS L3	L3-Q
Galileo E1	E1-C
Galileo E6	E6-C
Galileo E5a	E5a-Q
Galileo E5b	E5b-Q
Galileo E5AltBOC	E5AltBOC-Q
BeiDou B1C	B1C_pilot
BeiDou B2a	B2a_pilot
BeiDou B2b	B2b_I

See also the corresponding RINEX observation code in section 4.1.10.

2.3 Time Management

All time tags in the receiver refer to the receiver time scale. The receiver is designed in such a way that the receiver time is kept as close as possible to the selected GNSS system time (GPS or Galileo as prescribed by the **setTimingSystem** command). Internally, the receiver time is kept in two counters: the time-of-week counter in integer milliseconds (TOW) and the week number counter (WNC). WNC counts the number of complete weeks elapsed since January 6, 1980 (even if the selected GNSS system time is not GPS). The TOW and WNC counters are reported in all SBF blocks.

The synchronization of TOW and WNC with the GNSS system time involves the following steps:

- Upon powering up the receiver, TOW and WNC are assumed unknown, and set to a "Do-Not-Use value" in the SBF blocks.
- The transmission time-of-week and week number are decoded from the GNSS satellites:
 - As soon as the first time-of-week is decoded from the satellites, the TOW counter is initialized to within 20 ms of GNSS system time and starts counting. This is also the time when the receiver starts generating GNSS measurements (pseudoranges and carrier phases).
 - As soon as the week number is decoded from the satellites (which can be either simultaneously with the time-of-week, or several seconds later), the WNC counter is set and starts counting.
- After the first position and time fix has been computed (for which measurements from at least 4 satellites are required), TOW is set to within X milliseconds of GNSS time. This is done by introducing a jump of an integer number of milliseconds in the TOW counter. X is the maximal allowed offset between the receiver time and GNSS time, and is set by the **setClockSyncThreshold** command (by default, X=0.5ms). This initial clock synchronization leads to a simultaneous jump in all the pseudorange and carrier phase measurements.

The level to which the receiver time is synchronized with the GNSS system time is given by three status bits (TOWSET, WNCSET and FINETIME) available both in the `ReceiverTime` SBF block and the `ReceiverStatus` SBF block.

The receiver clock can be configured in free-running mode, or in steered mode using the command **setClockSyncThreshold**.

2.3.1 Free-Running Clock

In free-running mode, the receiver time slowly drifts with respect to GNSS time. The receiver continuously monitors this time offset: this is the clock bias term computed in the PVT solution, as provided in the `RxClkBias` field of the `PVTCartesian` and `PVTGeodetic` SBF blocks. A clock jump of an integer number of milliseconds is imposed on the receiver clock each time the clock bias exceeds X milliseconds by an absolute value (X is set by **setClockSyncThreshold**). This typically results in a saw-tooth profile similar to that shown in Figure 2-1. In this example, X=0.5ms and each time the clock bias becomes greater than 0.5ms, a jump of 1ms is applied.

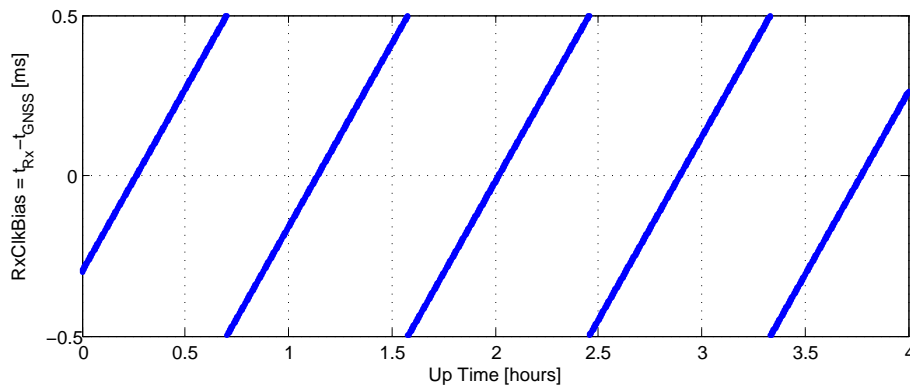

Figure 2-1: Example of the evolution of the receiver time offset with respect to the GNSS time in free-running mode.

When a receiver clock jump occurs, all measurements jump simultaneously. For example, a clock jump of 1ms will cause all the pseudoranges to jump by $0.001s * \text{velocity_of_light} = 299792.458m$. The jump is applied on both the pseudoranges and the carrier phase measurements, and hence will not be seen on a code-minus-phase plot.

The cumulated clock jumps since the last reset of the receiver is reported in the `CumClkJumps` field of the `MeasEpoch` SBF block.

2.3.2 Clock Steering

In steered mode, the receiver time is continuously steered to GNSS time to within a couple of nanoseconds. In the example of Figure 2-1, if the user would have enabled clock steering one hour after start up of the receiver, the clock bias would have been like in Figure 2-2 below.

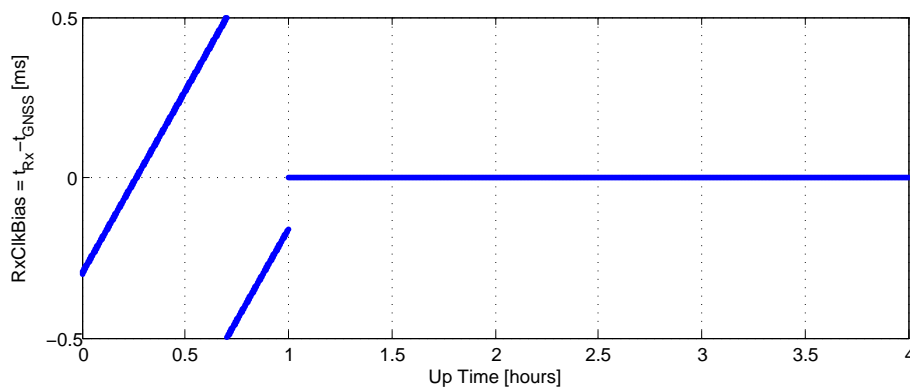

Figure 2-2: Effect of clock steering on the clock bias (clock steering enabled at an up time of 1 hour).

Clock steering accuracy is dependent on the satellite visibility, and it is recommended to only enable it under open-sky conditions.

Bit 3 of the `CommonFlags` field of the `MeasEpoch` SBF block indicates whether clock steering is active or not.



Note for the users of a GNSS constellation simulator:

When using a constellation simulator, make sure to set the simulation time after January 01, 2016. The receiver time will be incorrect before that date.

For correct time determination, it is mandatory to reset the receiver before every (re)start of the simulation.

2.4 Computation of Position, Velocity, and Time (PVT Solution)

The receiver computes the position, velocity and time (PVT) based on the pseudoranges, the Doppler measurements and, if applicable, the differential corrections.

The availability of the PVT depends on:

- the number of available pseudoranges and Doppler measurements, equal to the number of tracked satellites, or a subset of them as specified by the **setSatelliteUsage** command;
- the number of valid sets of broadcast ephemerides, which are needed to compute the position, velocity, and clock bias for each tracked satellite;
- the number of valid sets of fast and long-term SBAS corrections and their age in the case of SBAS-aided positioning;
- the number of valid differential corrections and their age in the case of DGPS/RTK positioning.

A position fix requires a minimum of 4 tracked satellites with associated ephemerides. When a PVT solution is not available, PVT-related SBF blocks are still output with all the numeric fields set to Do-Not-Use values, and with the `ERROR` field set to indicate the source of the problem.

The accuracy of the PVT depends on:

- The signal level.
- The geometry of the satellite constellation expressed in the DOP values: these values indicate the ratio of positional errors to range errors and are computed on the basis of the error propagation theory. When the DOP is high, the accuracy of positioning will be low.
- The number of available satellites: the more satellites are available, the lower the DOP. Measurement redundancy also enables better outlier detection.
- Multipath errors on the pseudorange measurements: multipath errors can be largely attenuated by enabling the APME multipath mitigation method (see **setMultipathMitigation**) and/or using code smoothing (see **setSmoothingInterval**).
- The PVT mode as set by the **setPVTMode** command.
- The data available to compute ionospheric delays (see **setIonosphereModel**).
- The choice of the dynamics model: if the dynamics parameter set by the **setReceiverDynamics** command does not correspond to the actual dynamics of the receiver platform, the position estimation will be sub-optimal.

The a-posteriori accuracy estimate of the computed position is reported in the variance-covariance matrix, which comes in the `PosCovCartesian` and `PosCovGeodetic` SBF blocks. This accuracy estimate is based on the assumed measurement noise model and may differ from actual errors due to many external factors, most of all multipath.

2.4.1 SBAS Positioning

SBAS, which stands for 'Space Based Augmentation System', enables differential operation over a large area with associated integrity information. System errors are computed from a dataset recorded over a continental area and disseminated via a geostationary satellite. The operation of SBAS is documented in the RTCA DO 229 standard. SBAS improves over DGPS corrections, in that it provides system corrections (ionosphere corrections and ephemeris long-term corrections) next to range corrections (the "fast corrections" in the DO 229 terminology).

The receiver provides an SBAS-aided position when it has sufficient satellites with at least fast and long-term corrections. The corrections are used as long as their applicability has not timed out. During the time-out interval the receiver applies correction degradation using the information received in message type (MT) 07 and 10.

By default, the receiver selects the SBAS satellite with the most SBAS corrections available. With the `setSBASCorrections` command, it is possible to force the receiver to use a particular SBAS satellite or a particular SBAS provider.

2.4.2 DGPS Positioning

DGPS (Differential GPS) is a pseudorange-based positioning technique where GNSS system errors are reduced by the use of range corrections. To work in DGPS rover mode, the receiver needs to receive differential corrections in the RTCM or CMR format.

Note on the RTCM v2.x corrections: the receiver takes the τ_{gd} parameter transmitted by the GPS satellites into account during the computation of the pseudorange corrections, as prescribed in v2.2 and v2.3 of the RTCM standard. The RTCM standard version 2.1 is ambiguous in this respect: it does neither prescribe nor discourage the use of τ_{gd} . The receiver can be configured in both modes using the command `setRTCMv2Compatibility`.

2.4.3 RTK Positioning

Real-Time Kinematic (RTK) is a carrier phase positioning method where the carrier phase ambiguities are estimated in a kinematic mode.

To work in RTK mode, the receiver requires the reception of RTK messages. Both the RTCM and the CMR message formats are supported. The base station providing these RTK messages can be either static or moving. Multiple-base RTK is not supported: by default, the receiver selects the nearest base station if more than one base station is available.

In RTK mode, the absolute position is reported in the `PVTCartesian` or `PVTGeodetic` SBF blocks, and the baseline vector is reported in the `BaseVectorCart` and `BaseVectorGeod` SBF blocks.

2.4.3.1 Integer Ambiguities (RTK-fixed)

The key to high-accuracy carrier phase positioning is the fixing of the carrier phase integer ambiguities. Under normal circumstances the receiver will compute the integer ambiguities within several seconds and yield an RTK-fixed solution with centimeter-level accuracy. The less accurate pseudorange measurements will not be used. As long as no cycle slips or loss-of-lock events occurs, the carrier phase position is readily available.

RTK with fixed ambiguities is also commonly referred to as phase positioning using 'On-The-Fly' (OTF) ambiguity fixing. The RTK positioning engine of the receiver uses the LAMBDA method⁽¹⁾ developed at Delft University, department of Geodesy.

2.4.3.2 Floating Ambiguities (RTK-float)

When data availability is low (e.g. low number of satellites) or when the data are not of sufficient quality (high multipath), the receiver will not fix the carrier phase ambiguities to their integer value, but will keep them floating. At the start of the RTK-float convergence process, the position accuracy is equal to that of code-based DGPS. Over the course of several minutes the positional accuracy will converge from several decimeters to several centimeters as the floating ambiguities become more accurate.

2.4.3.3 Moving Base

In RTK, the base station does not necessarily need to be static. In some applications, one is interested in the relative positioning of two moving vehicles. In that case, both base and rover receivers are mounted on moving platforms and the RTK engine computes the baseline between them. If both base and rover receivers are mounted on the same vehicle, the baseline can be used to determine the orientation of the vehicle (see section 1.7). If accurate absolute positioning is required in addition to relative positioning, the moving base receiver can operate in RTK mode and get RTK correction from a fixed base station (see section 1.5.2).

With the command `setDiffCorrUsage`, the rover receiver must be informed that the base is moving. The baseline coordinates and orientation is contained in the `BaseVectorCart` and `BaseVectorGeod` SBF blocks.

Due to delays in the generation and transmission of the RTK data (base station position and measurements) from the base to the rover, the RTK data has a certain "age" when received by the rover. When operating with a moving base station, the RTK engine is of the "low-latency" type. This means that, when the rover computes its RTK position at time t_0 , it extrapolates the most recently received RTK data from the base to time t_0 . The accuracy of this extrapolation, and hence the accuracy of the final RTK solution, degrades with the age of the RTK data. Therefore it is essential that the base sends its position and measurements at a sufficient rate.

The default rate of 1 Hz is adequate in the case of a static base station, but is generally too low for a moving base with a non-constant velocity. In moving base operation, it is recommended to set the RTK data rate to its maximum allowed value of 10 Hz. Not only the RTK data rate,

⁽¹⁾ Teunissen, P.J.G., and C.C.J.M. Tiberius (1994) Integer least-squares estimation of the GPS phase ambiguities. Proceedings of International Symposium on Kinematic Systems in Geodesy, Geomatics and Navigation KIS'94, Banff, Canada, August 30-September 2, pp. 221-231.

but also the communication link latency is important. Especially in moving base, it is essential to have a low-latency communication link between base and rover.

2.4.4 Transition between PVT Modes

Whenever possible, the transitions from a more accurate PVT mode to a less accurate PVT mode are smooth. For example, when switching from RTK to DGPS mode, the position does not exhibit a sudden jump, but slowly degrades from RTK to DGPS accuracy.

2.4.5 Datum Transformation

By default the datum to which the coordinates refer depends on the positioning mode. For standalone and SBAS positioning for example, the coordinates refer to a global datum: WGS84 or ITRS. When using DGPS or RTK corrections from a DGPS/RTK provider, the coordinates usually refer to a regional datum (e.g. ETRS89 in Europe).

Recent realisations of WGS84 and ITRS are closely aligned and the difference can be neglected in most cases. The receiver considers them equivalent. However, regional datums may significantly differ from WGS84/ITRS, which may lead to coordinate jumps when switching between different positioning modes.

2.4.5.1 Transformation to Regional Datum

It is possible to avoid this datum shift by configuring the receiver to transform all coordinates to the regional datum used by the RTK base stations. This is done with the `setGeodeticDatum` command. The receiver knows the transformation parameters applicable to the most common datums (e.g. ETRS89 or NAD83), but user datums can also be defined with the `setUserDatum` command.

Coordinates in the `PVTCartesian` and `PVTGeodetic` SBF blocks refer to the datum selected in `setGeodeticDatum`. The datum can be checked by decoding the `Datum` field of these blocks.

2.4.5.2 Transformation to Local Datum

Sometimes it is needed to relate the coordinates to a local datum. Some RTK networks provide the necessary transformation and projection parameters as part of their RTCM stream, in message types 1021 to 1027.

The local geodetic coordinates (latitude, longitude and height) are reported in the `PosLocal` SBF block, and the plane grid coordinates (easting, northing, height) are reported in the `PosProjected` SBF block.

The following conditions must be met for the receiver to provide local coordinates from the information sent by the RTK network:

- the usage of RTCM v3.x MT1021-1027 must be enabled by the command `setRTCMv3Usage` (these messages are enabled by default).

- the local coordinate operations must be set to `NETWORK` with the `setLocalCoordOperation` command (this is the default).
- the complete set of datum transformation messages must have been received from the network. Plane grid coordinates are only available if the network supports one of the messages in the 1025-1027 range. Otherwise, only the local latitude, longitude and height are available.
- the position must be in the area of validity of the transformation parameters.
- to continue to get unbiased local coordinates when the positioning mode is not DGPS or RTK, the network regional datum must be set with the `setGeodeticDatum` command. See section 2.4.5.1.

A number of local datum transformations are preloaded in the receiver (the list can be retrieved with the `1stLocalCoordOperations` command). If your local datum belongs to this list, local coordinates can be computed without information from the RTK network. See the `setLocalCoordOperation` command for details.

2.5 Antenna Effects

To achieve the highest positioning precision, it is essential to take antenna effects into account.

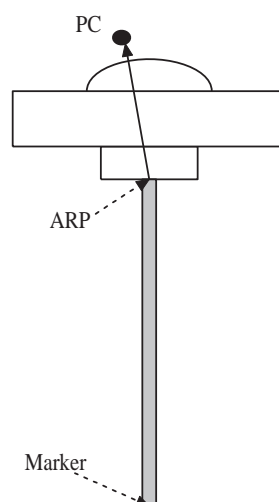

Figure 2-3: Antenna mount.

The GNSS measurements (pseudoranges and carrier phases observables) refer to a theoretical point in space called the phase center (noted PC in Figure 2-3). The position of this point is dependent on the elevation of the satellite and on the frequency band. It varies with time and it is different for the different GNSS frequency bands. The phase center variation can reach a few centimeters.

If no correction is applied, the computed position refers to an average phase center with no easy link with the antenna physical element. This average phase center fluctuates with time and cannot be used for accurate millimeter-level positioning.

For high-precision positioning, the GNSS measurements need to be corrected in such a way that they all refer to a common and stable point in space. That point is referred to as the antenna reference point (ARP). For convenience, it is usually selected at the center of the

bottom surface of the antenna. PC to ARP calibration tables are available on Internet for a large number of geodetic-grade antennas. For example, the National Geodetic Survey (NGS) publishes calibration tables that can be downloaded from the following URL:

<https://www.ngs.noaa.gov/ANTCAL/>.

The antenna naming convention in such table is the one adopted by the IGS Central Bureau.

The receiver has a similar table in its non-volatile memory. This table can be upgraded following the standard upgrade procedure as described in section 1.22 (the upgrade file is named `ant_info.suf`).

2.5.1 Antenna Effects in Rover Mode

If the user specifies the type of his/her antenna using the `setAntennaOffset` command, the receiver compensates for the phase center variation in all rover positioning modes. If the antenna is not specified, or the antenna type is not present in the built-in antenna calibration file, the receiver cannot make the distinction between phase center and ARP, and the position accuracy is slightly degraded, especially in the height component.

The point to be positioned is the "marker" (see Figure 2-3). The offset between the ARP and the marker is a function of the antenna monumentation. It must be measured by the user and specified with the `setAntennaOffset` command.

The absolute position reported in the `PVTCartesian` and `PVTGeodetic` SBF blocks is always the marker position.

In DGPS or RTK modes, the receiver needs to know the type of antenna used at the base station in order to properly compensate for the phase center variation at the base. This information is typically included in the correction stream received from the base station.

The base-to-rover baseline coordinates in the `BaseVectorCart` and `BaseVectorGeod` SBF blocks is from ARP to ARP unless the receiver is not able to properly compensate for the phase center variation at base or rover. Refer to the description of the `BaseVectorCart` SBF blocks for details.

2.5.2 Antenna Effects in Base Mode

Phase center compensation always happens at the rover side. The base station sends uncompensated measurements in its differential correction messages, together with its ARP position and antenna type. The antenna type information allows the rover to apply the appropriate phase center compensation to the base measurements.

When setting up a base station, it is therefore important that the coordinates entered with the `setStaticPosGeodetic` or the `setStaticPosCartesian` commands refer to the ARP. The coordinates are encoded without change in the relevant differential correction messages. The antenna type must be provided with the `setAntennaOffset` command.

Chapter 3

Command Line Reference

3.1 Command Line Interface Outline

The receiver outputs a prompt when it is ready to accept a user command. The prompt is of the form:

```
CD>
```

where `CD` is the connection descriptor of the current connection, e.g. `COM1` (see section 1.1.5).

The prompt indicates the termination of the processing of a given command. When sending multiple commands to the receiver, it is necessary to wait for the prompt between each command.

Sometimes a connection is not configured to accept user commands, for example because it is put into differential correction input mode. A way to force a connection to accept commands is to send a succession of ten "S" characters to that connection and then to press the enter key (`SSSSSSSSSS<CR>`). See also the description of the `setDataInOut` command.

3.1.1 Command Types

Most commands fall into one of the following categories:

- set**-commands to change one or more configuration parameters;
- get**-commands to get the current value of one or more configuration parameters;
- exe**-commands to initiate some action;
- lst**-commands to retrieve the contents of internal files or list the commands.

Each **set**-command has its **get**-counterpart, but the opposite is not true. For instance, the `setNMEAOutput` command has a corresponding `getNMEAOutput`, but `getReceiverCapabilities` has no **set**-counterpart. Each **exe**-command also has its **get**-counterpart which can be used to retrieve the parameters of the last invocation of the command.

3.1.2 Command Line Syntax

Each ASCII command line consists of a command name optionally followed by a list of arguments and terminated by `<CR>`, `<LF>` or `<CR><LF>` character(s) usually corresponding to pressing the "Enter" key on the keyboard.

To minimize typing effort when sending commands by hand, the command name can be replaced by its 3-5 character mnemonic. For instance, `grc` can be used instead of `getReceiverCapabilities`.

The receiver is case insensitive when interpreting a command line.

The maximum length of any ASCII command line is 2000 characters.

For commands requiring arguments, the comma "," must be used to separate the arguments from each other and from the command's name. Any number of spaces can be inserted before and after the comma.

Each argument of a **set**-command corresponds to a single configuration parameter in the receiver. Usually, each of these configuration parameters can be set independently of the others, so most of the **set**-command's arguments are optional. Optional arguments can be omitted but if omitted arguments are followed by non-omitted ones, a corresponding number of commas must be entered. Omitted arguments always keep their current value.

3.1.3 Command Replies

The reply to ASCII commands always starts with "\$R" and ends with <CR><LF> followed by the prompt corresponding to the connection descriptor you are connected to.

The following types of replies are defined for ASCII commands:

- For comment lines (user input beginning with "#") or empty commands (just pressing "Enter"), the receiver replies with the prompt.

```
COM1> # This is a comment! <CR>
COM1>
```

- For invalid commands, the reply is an error message, always beginning with the keyword "\$R?" followed by an error message.
- For all valid **set**-, **get**- and **exe**-commands, the first line of the reply is an exact copy of the command as entered by the user, preceded with "\$R:". One or more additional lines are printed depending on the command. These lines report the configuration of the receiver after execution of the command.

```
COM1>setNMEAOutput, stream1, com1, GGA, sec1 <CR>
$R: setNMEAOutput, stream1, com1, GGA, sec1
  NMEAOutput, stream1, com1, GGA, sec1
COM1>
```

For commands which reset or halt the receiver (e.g. **exeResetReceiver**), the reply is terminated by "STOP>" instead of the standard prompt, to indicate that no further command can be entered.

- For all valid **lst**-commands, the first line of the reply is an exact copy of the command as entered by the user, preceded with "\$R;". The second line is a pseudo-prompt "---->" and the remaining of the reply is a succession of formatted blocks, each of them starting with "\$-- BLOCK".

ASCII replies to **set-**, **get-** and **exe-**commands, including the terminating prompt, are atomic: they cannot be broken by other messages from the receivers. For the **lst-**commands, the replies may consist of several atomic formatted blocks which can be interleaved with other output data. If more than one formatted block is output for a **lst-**command, each of the intermediate blocks is terminated with a pseudo-prompt "**----->**". The normal prompt will only be used to terminate the last formatted block of the reply so that one single prompt is always associated with one command.

3.1.4 Command Syntax Tables

All ASCII commands are listed in section 3.2. Each command is introduced by a compact formal description of it called a "syntax table". Syntax tables contain a complete list of arguments with their possible values and default settings when applicable.

The conventions used in syntax tables are explained below by taking a fictitious **setCommandName** command as example. The syntax table for that command is:

scn gcn	setCommandName getCommandName	Cd Cd	Distance	Time	Message (120)	Password (40)	Mode	PRN
		+ Com1 + Com2 all	-20.00 ... <u>0.00</u> ... 20.00 m	1 ... 50 sec	<u>Unknown</u>		<u>on</u> off	none + G01 ... G32 + S120 ... S138 + SBAS + <u>GPS</u> all

[GUI: Navigation > Receiver Operation > Example](#)

The associated **set-** and **get-**commands are always described in pairs, and the same holds for the associated **exe-** and **get-**commands. The command name and its equivalent 3-5 character mnemonic are printed in the first two columns. The list of arguments for the **set-** and **get-**commands is listed in the first and second row respectively. In our example, **setCommandName** can accept up to 6 arguments and **getCommandName** only accepts one argument. Mandatory arguments are printed in bold face. Besides the mandatory arguments, at least one of the optional arguments must be provided in the command line.

The list of possible values for each argument is printed under each of them. Default values for optional arguments are underlined.

The link printed in blue under the syntax table shows under which GUI menu the command can be found.

The fictitious command above contains all the possible argument types:

- *Cd* serves as an index for all following arguments. This can be noticed by the possibility to use this argument in the **get-**command. This argument is mandatory in the **set-**command. The accepted values are **COM1**, **COM2** and **all**, corresponding to the first or second serial ports, or to both of them respectively. The "+" sign before the first two values indicates that they can be combined to address both serial ports in the same command.

Examples: `COM1`, `COM1+COM2`, `all` (which is actually an alias for `COM1+COM2`).

- *Distance* is a number between `-20` and `20` with a default value of `0`, and up to 2 decimal digits. An error is returned if more digits are provided. The "m" indicates that the value is expressed in meters. Note that this "m" should not be typed when entering the command.

Examples: `20`, `10.3`, `-2.34`

- *Time* is a number between `1` and `50`, with no decimal digit (i.e. this is an integer value). This value is expressed in seconds.

Examples: `1`, `10`

- *Message* is a string with a maximum length of 120 characters. The default value of that argument is "Unknown". When spaces must to be used, the string has to be put between quotes and these enclosing quotes are not considered part of the string. The list of allowed characters in strings is:

```

ABCDEFGHIJKLMNPOQRSTUVWXYZabcdefghijklmnopqrstuvwxyz0123456789
!#%&()*+,-./:;<=>?[\]^_`{|}~
  
```

Example: `"Hello World!"`

- *Password* is a password argument with a maximum length of 20 characters (40/2). Password arguments are always named *Password* or *Key*. Only half of the total password length is available to the user, the other half being reserved by the system. Passwords are obfuscated by the receiver so that they cannot be read back in command replies. In addition to the characters above (see the *Message* argument), special characters are allowed in passwords using the corresponding escape sequence:
 - Type `%%DQ` to obtain `"`
 - Type `%%SQ` to obtain `'`
 - Type `%%DL` to obtain `$`
 - Type `%%AM` to obtain `&`
 - Type `%%CM` to obtain `,`

Example: `"ab%%AM123"`

- *Mode* is a range of individual values that cannot be combined (they are not preceded by a "+" sign). Either `off` or `on` can be selected for that argument and the default value is `on`.

Example: `on`

- *PRN* is a range of values that can be combined together with the "+" sign. The default value `GPS` is an alias for `G01+G02+ ... +G32`, `SBAS` is an alias for `S120+ ... +S138` and `all` an alias for `GPS+SBAS`. A "+" sign can be set before the argument to indicate to add the specified value(s) to the current list. If the value "none" is supported (which is the case in this example), a "-" sign can be set before the argument to remove the specified value(s) from the current list. It is possible to add or remove multiple values at once by "adding" or "subtracting" them with the "+" or "-" operator. However, "+" and "-" can never be combined in a single argument.

Examples: `G01+G02`, `+G03`, `GPS+S120`, `+G04+G05`, `-S122-S123`, `-GPS`

3.2 Command Definitions

3.2.1 Receiver Administration

lai	IstAntennaInfo	Antenna								
		Overview Main [antenna name]								

Use this command with the argument *Antenna* set to *Overview* to get a list of all antenna names for which the receiver knows the phase center variation parameters (see section 2.5).

Use this command with the argument *Antenna* set to one of the antenna names returned by **lstAntennaInfo**, **Overview** to retrieve the complete phase center variation parameters for that particular antenna. Do not forget to enclose the name between double quotes if it contains whitespaces.

Using the values *Main* will return the phase center variation parameters corresponding to the main antenna type as specified in the command **setAntennaOffset**.

Examples

```
COM1> lai, Overview <CR>
$R; lai, Overview
<?xml version="1.0" encoding="ISO-8859-1" ?>
<AntennaInfo version="0.1">
  <Antenna ID="AERAT1675_29      NONE"/>
  <Antenna ID="AERAT2775_150    NONE"/>
  <Antenna ID="AERAT2775_159    "/>
  <Antenna ID="AERAT2775_159    SPKE"/>
  <Antenna ID="AERAT2775_160    "/>
  ...
  <Antenna ID="TRM_R8_GNSS      "/>
</AntennaInfo>
COM1>
```

```
COM1> lai, "AERAT2775_159 SPKE"<CR>
$R; lai,"AERAT2775_159  SPKE"
<?xml version="1.0" encoding="ISO-8859-1" ?>
<AntennaInfo version="0.1">
  <Antenna ID="AERAT2775_159  SPKE"/>
  <L1>
    <offset north="0.4" east="0.1" up="77.2"/>
    <phase elevation="90" value="0.0"/>
    <phase elevation="85" value="-0.2"/>
    ...
    <phase elevation=" 5" value="0.0"/>
    <phase elevation=" 0" value="0.0"/>
  </L1>
</AntennaInfo>
COM1>
```

help	lstCommandHelp	Action (255)								
		Overview								

Use this command to retrieve a short description of the ASCII command-line interface.

When invoking this command with the `Overview` argument, the receiver returns the list of all supported **set-**, **get-** and **exe-**commands. The `lstCommandHelp` command can also be called with any supported **set-**, **get-** or **exe-**command (the full name or the mnemonic) as argument.

The reply to this command is free-formatted and subject to change in future versions of the receiver's software. This command is designed to be used by human users. When building software applications, it is recommended to use the formal `lstMIBDescription`.

Examples

```
COM1> help, Overview <CR>
```

```
$R; help, Overview
```

```
$-- BLOCK 1 / 0
```

```
MENU: communication
```

```
GROUP: ioSelection
```

```
sdio, setDataInOut
```

```
gdio, getDataInOut
```

```
...
```

```
COM1>
```

```
COM1> help, getReceiverCapabilities <CR>
```

```
$R; help, getReceiverCapabilities
```

```
... Here comes a description of getReceiverCapabilities ...
```

```
COM1>
```

```
COM1> help, grc <CR>
```

```
$R; help, grc
```

```
... Here comes a description of getReceiverCapabilities ...
```

```
COM1>
```

lcf	IstConfigFile	File								
		Current Boot RxDefault User1 User2								

Use this command to list the contents of a configuration file. A configuration file contains the list of user commands needed to bring the receiver from factory default to a certain non-default configuration.

The following configuration files are available:

File	Description
Current	The current configuration.
Boot	The configuration that is loaded at boot time, after a power cycle or after a hard reset (see also the exeResetReceiver command).
RxDefault	The default configuration.
User1	A user-defined configuration.
User2	A user-defined configuration.

See also the related **exeCopyConfigFile** command to learn how to manage configuration files.

Example

```

COM1> smp, TestMarker <CR>
$R: smp, TestMarker
    MarkerParameters, "TestMarker"
COM1> lcf, Current <CR>
$R; lcf, Current
$-- BLOCK 1 / 1
    setMarkerParameters, "TestMarker"
COM1>
    
```

eccf gccf	exeCopyConfigFile getCopyConfigFile	Source	Target							
		Current Boot User1 User2 RxDefault	Current Boot User1 User2							

RxControl: File > Copy Configuration

Use this command to manage the configuration files. See the **lstConfigFile** command for a description of the different configuration files.

With this command, the user can copy configurations files into other configuration files. For instance, copying the `Current` file into the `Boot` file makes that the receiver will always boot in the current configuration.

Examples

To save the current configuration in the `Boot` file, use:

```
COM1> eccf, Current, Boot <CR>
$R: eccf, Current, Boot
    CopyConfigFile, Current, Boot
COM1>
```

To load the configuration stored in `User1`, use:

```
COM1> eccf, User1, Current <CR>
$R: eccf, User1, Current
    CopyConfigFile, User1, Current
COM1>
```

seth	setEthernetMode	<i>Enable</i>								
geth	getEthernetMode									
		off on								

RxControl: Communication > Network Settings > General

Use this command to turn the Ethernet interface on or off. Turning Ethernet off reduces the receiver power consumption.



Before turning Ethernet off, make sure that the receiver will still be accessible through another interface (serial, USB,...). This is especially important for remote receivers. It will not be possible to access the receiver over Ethernet after invoking the **setEthernetMode, off** command.

Example

```
COM1> seth, on<CR>
$R: seth, on
    EthernetMode, on
COM1>
```

efup	exeFTPUpgrade	Server (32)	Path (64)	Login (12)	Password (24)					
gfup	getFTPUpgrade			anonymous						

RxControl: File > Upgrade Receiver using FTP

Use this command to upgrade the receiver by fetching the upgrade file from an FTP server. The arguments specify the FTP server, the path to the upgrade file (.SUF format), and the login and password to use.

This procedure always resets the receiver, even if the upgrade file does not exist.

Before resetting, the receiver broadcasts a "\$TE ResetReceiver" message to all active communication ports, to inform all users of the imminent reset.

After a reset, the user may have to adapt the communication settings of his/her terminal program as they may be reset to their default values.

Example

```
COM1> efup, myftp.com, /tst.suf, user, password<CR>
$R: efup, myftp.com, /tst.suf, user, password
    FTPUpgrade, "myftp.com", "/tst.suf", "user",
        "I301I5B8DG8E7QTT6RZT7IQ"
STOP>
$TE ResetReceiver Upgrade
STOP>
```

sgpf ggpf	setGPIOFunctionality getGPIOFunctionality	GPPin GPPin	Mode	Input	Output					
		+ GP1 + GP2 all	Output	none	LevelLow LevelHigh					

[RxControl: Navigation > Receiver Operation > GPIO](#)

Use these commands to define/inquire the functionality assigned to every GPIO pin.

Currently, only the output pins (GP_x) can be controlled by this command, and the *Mode* and *Input* arguments can only take the values `Output` and `none` respectively. The argument *Output* sets the electrical level to be applied to the pin specified in *GPPin*.

In housed products, the number of GPIO pins configurable by this command is larger than the number of GPIO pins available to the user. The extra pins are used for internal purposes, and their settings should not be modified. Please refer to the Hardware Manual or the User Manual of your product to check which GPIO pins are available.

Example

To set the signal on GP2 to a logical 1, use:

```
COM1> sgpf, GP2, Output, , LevelHigh <CR>
$R: sgpf, GP2, Output, , LevelHigh
    GPIOFunctionality, GP2, Output, none, LevelHigh
COM1>
```

lif	IstInternalFile	File								
		Permissions Identification Debug Error SisError DiffCorrError SetupError IPParameters RxMessages								

Use this command to retrieve the contents of one of the receiver internal files:

File	Description
Permissions	List of permitted options in your receiver.
Identification	Information about the different components being part of the receiver (e.g. serial number, firmware version, etc.).
Debug	Program flow information that can help support engineers to debug certain issues.
Error	Last internal error reports.
SisError	Last detected signal-in-space anomalies.
DiffCorrError	Last detected anomalies in the incoming differential correction streams.
SetupError	Last detected anomalies in the receiver setup.
IPParameters	Hostname, MAC and IP addresses, DNS addresses, netmask and gateway.
RxMessages	Event log from the receiver. This is the list of the recent event log messages. These messages are also available in the RxMessage SBF block.

Example

```
COM1> lif, Permissions <CR>
$R; lif, Permissions
---->
$-- BLOCK 1 / 1
... here follows the permission file ...
COM1>
```

slm	setLEDMode	GPLED								
glm	getLEDMode									
		DIFFCORLED								
		PVTLED								
		TRACKLED								
		LOGLED								

[RxControl: Navigation > Receiver Operation > GPIO](#)

Use these commands to define/inquire the blinking mode of the General Purpose LED (GPLED).

The different LED blinking modes are described in the Hardware Manual or in the User Manual of your receiver.

Example

```
COM1> slm, DIFFCORLED <CR>
$R: slm, DIFFCORLED
    LEDMode, DIFFCORLED
COM1>
```

lmd	lstMIBDescription	File (255)								
		Overview SBFTable								

Use this command to retrieve the ASN.1-compliant syntax of the user command interface. The name of the command refers to the MIB (Management Information Base), which holds the whole receiver configuration. There is a one-to-one relationship between the formal MIB description and the ASCII command-line interface for all **exe-**, **get-** and **set-**commands.

When the value `Overview` is used, the general syntax of the interface is returned. With the value `SBFTable`, the receiver will output the list of supported SBF blocks and whether they can be output at a user-selectable rate or not. The **lstMIBDescription** command can also be called with every supported **set-**, **get-** or **exe-**command (the full name or the mnemonic) as argument.

No formal description of the **lst-**commands can be retrieved with **lstMIBDescription**.

Examples

```
COM1> lmd, Overview <CR>
$R; lmd, Overview
... Here comes the generic command syntax ...
COM1>
```

```
COM1> lmd, grc <CR>
$R; lmd, grc
... Here comes the description of getReceiverCapabilities ...
COM1>
```

grc	getReceiverCapabilities									
-----	-------------------------	--	--	--	--	--	--	--	--	--

[RxControl: Help > Receiver Interface > Permitted Capabilities](#)

Use this command to retrieve the so-called "capabilities" of your receiver. The first returned value is the list of supported antenna(s), followed by the list of supported signals, the list of available communication ports and the list of enabled features.

The three values at the end of the reply line correspond to the default measurement interval, the default PVT interval and the default integrated INS/GNSS interval respectively. This is the interval at which the corresponding SBF blocks are output when the `OnChange` rate is selected with the `setSBFOutput` command. These values are expressed in milliseconds.

Each of the above-mentioned lists contain one or more of the elements in the tables below.

Antennas	Description
Main	The receiver's main antenna.

Signals	Description
GPSL1CA	GPS L1 C/A signal.
GPSL1PY	GPS L1 P(Y) signal.
GPSL2PY	GPS L2 P(Y) signal.
GPSL2C	GPS L2 C signal.
GPSL5	GPS L5 signal.
GLOL1CA	GLONASS L1 C/A signal.
GLOL2P	GLONASS L2 P signal.
GLOL2CA	GLONASS L2 C/A signal.
GLOL3	GLONASS L3 signal.
GALL1BC	Galileo L1 BC signal.
GALE5a	Galileo E5a signal.
GALE5b	Galileo E5b signal.
GALE5	Galileo E5 AltBOC signal.
GEOL1	SBAS L1 C/A signal.
GEOL5	SBAS L5 signal.
BDSB1I	BeiDou B1I signal.
BDSB2I	BeiDou B2I signal.
BDSB3I	BeiDou B3I signal.
BDSB1C	BeiDou B1C signal.
BDSB2a	BeiDou B2a signal.
QZSL1CA	QZSS L1 C/A signal.
QZSL2C	QZSS L2 C signal.
QZSL5	QZSS L5 signal.

Signals (Continued)	Description
LBAND	MSS L-Band signal.
NAVICL5	NavIC/IRNSS L5 signal.

ComPorts	Description
COM1	Serial port 1.
COM2	Serial port 2.
COM3	Serial port 3.
COM4	Serial port 4.
USB1	USB-device virtual serial port 1.
USB2	USB-device virtual serial port 2.
IP10	TCP/IP port 1.
IP11	TCP/IP port 2.
IP12	TCP/IP port 3.
IP13	TCP/IP port 4.
IP14	TCP/IP port 5.
IP15	TCP/IP port 6.
IP16	TCP/IP port 7.
IP17	TCP/IP port 8.
NTR1	NTRIP port 1.
NTR2	NTRIP port 2.
NTR3	NTRIP port 3.
NTR4	NTRIP port 4.
IPS1	IP Server port 1.
IPS2	IP Server port 2.
IPS3	IP Server port 3.
IPS4	IP Server port 4.
IPS5	IP Server port 5.
IPI1	IP Receive port 1.
IPI2	IP Receive port 2.
IPI3	IP Receive port 3.
IPI4	IP Receive port 4.
IPI5	IP Receive port 5.

Capabilities	Description
SBAS	Positioning with SBAS corrections.
DGPSRover	Positioning with DGPS corrections.
DGPSBase	Generation of DGPS corrections.
RTKRover	Positioning with RTK corrections.

Capabilities (Continued)	Description
RTKBase	Generation of RTK corrections.
RTCMv23	Generation/decoding of RTCM v2.3 corrections.
RTCMv3x	Generation/decoding of RTCM v3.x corrections.
CMRv20	Generation/decoding of CMR v2.0 corrections.
TimeSync	Internal clock synchronisation to external PPS signal.
xPPSOutput	Generation of xPPS output signal.
TimedEvent	Accurate time mark of event signals.
InternalLogging	Internal logging.
APME	A-Posteriori Multipath Estimator.
RAIM	Receiver Autonomous Integrity Monitoring.
MovingBase	Usage of Moving Base.
MeasAv	Measurement availability.
IM	Interference mitigation.
FreqSync	External frequency input.
DataCollection	Onboard data collection.
Sapcorda	Sapcorda SSR corrections.

Example

```

COM1> grc <CR>
$R: grc
  ReceiverCapabilities, Main, GPSL1CA+GEOL1, COM1+COM2+COM3+COM4+
    USB1+USB2,
  APME+SBAS, 100, 100, 100
COM1>
  
```

gri	getReceiverInterface	Item								
		+ RxName + SNMPLanguage + SNMPVersion all								

[RxControl: Help > Receiver Interface > Interface Version](#)

Use this command to retrieve the version of the receiver command-line interface. The reply to this command is a subset of the reply returned by the **lstInternalFile, Identification** command.

Example

```

COM1> gri <CR>
$R: gri
  ReceiverInterface, RxName, AsterRx1
  ReceiverInterface, SNMPLanguage, English
  ReceiverInterface, SNMPVersion, 20060308
COM1>
    
```

era gra	exeRegisteredApplications getRegisteredApplications	Cd Cd	Application (12)							
		+ COM1 + COM2 + COM3 + COM4 + USB1 + USB2 + IP10 ... IP17 all	<u>Unknown</u>							

RxControl: Communication > Registration

Use these commands to define/inquire the name of the application that is currently using a given connection descriptor (*Cd* - see 1.1.5).

Registering an application name for a connection does not affect the receiver operation, and is done on a voluntary basis. Application registration can be useful to developers of external applications when more than one application is to communicate with the receiver concurrently. Whether or not this command is used, and the way it is used is up to the developers of external applications.

Example

```
COM1> era, com1, MyApp <CR>
$R: era, com1, MyApp
  RegisteredApplications, COM1, "MyApp"
  RegisteredApplications, COM2, "Unknown"
  RegisteredApplications, COM3, "Unknown"
  RegisteredApplications, USB1, "Unknown"
  RegisteredApplications, USB2, "Unknown"
COM1>
```

erst grst	exeResetReceiver getResetReceiver	<i>Level</i>	<i>EraseMemory</i>							
		Soft Hard Upgrade	none + Config + PVTData + SatData + HTTSPCertificate all							

RxControl: File > Reset Receiver

Use this command to reset the receiver and to erase some previously stored data. The first argument specifies which level of reset you want to execute:

Level	Description
Soft	This is a reset of the receiver's firmware. After a few seconds, the receiver will restart operating in the same configuration as before the command was issued, unless the "Config" value is specified in the second argument.
Hard	This is similar to a power off/on sequence. After hardware reset, the receiver will use the configuration saved in the boot configuration file.
Upgrade	Set the receiver into upgrade mode. After a few seconds, the receiver is ready to accept an upgrade file (SUF format) from any of its connections.

The second argument specifies which part of the non-volatile memory should be erased during the reset. The following table contains the possible values for the *EraseMemory* argument:

EraseMemory	Description
Config	<p>The receiver's configuration is reset to the factory default, with the following exceptions.</p> <p>The IP settings set by the setIPSettings and setIPPortSettings commands keep their value.</p> <p>The UHF table set by the setUHFChannelTable command is maintained.</p> <p>After reset, the <code>Current</code> and <code>Boot</code> configuration files are erased (see the exeCopyConfigFile command), but the <code>User1</code> and <code>User2</code> configuration files are kept unchanged.</p>
PVTData	The latest computed PVT data stored in non-volatile memory is erased.
SatData	All satellite navigation data (ephemeris, almanac, ionosphere parameters, UTC, ...) stored in non-volatile memory is erased.
HTTSPCertificate	Remove current HTTPS certificate. It will be replaced by a self-signed certificate at boot.

Before resetting, the receiver broadcasts a "\$TE ResetReceiver" message to all active communication ports, to inform all users of the imminent reset.

After a reset, the user may have to adapt the communication settings of his/her terminal program as they may be reset to their default values.

Example

```
COM1> erst, soft, none <CR>
$R: erst, soft, none
  ResetReceiver, Soft, none
STOP>
$TE ResetReceiver Soft
STOP>
```

3.2.2 Standby and Sleep Configuration

epwm	exePowerMode	<i>Mode</i>								
gpwm	getPowerMode									
		StandBy								

RxControl: File > Power Mode > Shut Down

Use this command to set the receiver in sleep or standby mode, in which it consumes only a fraction of its normal operational power.

When in standby mode, the receiver can be awoken by sending the appropriate signal to one of its input pins (see the receiver Hardware Manual or User Manual for details).

Upon waking up, the receiver applies the configuration that is stored in the boot configuration file (see the **1stConfigFile** command).

Before entering standby mode, the receiver broadcasts a "\$TE PowerMode" message to all active communication ports, to inform all users of the imminent halt.

Example

```
COM1> epwm, Standby <CR>
$R: epwm, Standby
    PowerMode, StandBy
STOP>
$TE PowerMode Standby
STOP>
```

3.2.3 User Management

lcu	lstCurrentUser									

Use this command to check which user is currently logged in on this port, if any. See also the **login** command.

Example

```
COM1> lcu <CR>
$R! lstCurrentUser
    Not logged in.
COM1> login, admin, admin <CR>
$R! LogIn
    User admin logged in.
COM1> lcu <CR>
$R! lstCurrentUser
    Logged in as admin.
COM1>
```

sdal	setDefaultAccessLevel	Web	FileTransfer	Ip	Com	Usb				
gdal	getDefaultAccessLevel	none	none	none	none	none				
		Viewer	Viewer	Viewer	Viewer	Viewer				
		User	User	User	User	User				

RxControl: File > User Management

This command defines what an anonymous user is authorized to do when connected to the receiver. An anonymous user is one who has not logged in with the **login** command.

The anonymous authorization level can be set independently for the different interfaces.

For all arguments except *FileTransfer*, setting the authorization level to `User` grants full control of the receiver to the anonymous user connected through the corresponding connection. The `Viewer` level allows the anonymous user to view the receiver configuration without changing it (i.e. to only issue **get**-commands). `none` prevents anonymous users from viewing or changing the configuration.

For the *FileTransfer* argument, `Viewer` means that the anonymous user is allowed to download log files from the receiver using FTP, but not to delete them. `User` means that the anonymous user can both download and delete files, and `none` disables anonymous accesses.

To perform actions not allowed to anonymous users, you first need to authenticate yourself by entering a *UserName* and *Password* through the **login** command.

See also the commands **setUserAccessLevel** to learn how to define user accounts.

This command does not change the status of existing connections. For example, for *Com* or *Usb* connections, it will only take effect after a reset.

Example

```
COM1> sdal, User, none, User, Viewer, none<CR>
$R: sdal, User, none, User, Viewer, none
    DefaultAccessLevel, User, none, User, Viewer, none
COM1>
```

login	Login	UserName (16)	Password (32)							

Use this command to authenticate yourself. When initially connecting to the receiver, a user is considered "anonymous". The level of control granted to anonymous users is defined by the command **setDefaultAccessLevel**.

To perform actions not allowed to anonymous users, you need to authenticate yourself by entering a *UserName* and *Password* through the **login** command.

The list of user names and passwords and their respective access level can be managed with the **setUserAccessLevel** command. Login fails if the provided *UserName* or *Password* is not in that list.

The **logout** command returns to unauthenticated (anonymous) access. The **lstCurrentUser** command can be invoked to find out which user is logged in on the current port.

It is not necessary to log out before logging in as a different user.

Examples

To log in as user "admin" with password "admin", use

```
COM1> login, admin, admin <CR>
$R! LogIn
  User admin logged in.
COM1>
```

Logging in with a wrong username or password gives an error:

```
COM1> login, foo, foo <CR>
$R? LogIn: Wrong username or password!
COM1>
```

If the user does not have sufficient access right, some commands may give an error:

```
COM1> sso, Stream1, COM1, MeasEpoch, sec1 <CR>
$R? SBFOutput: Not authorized!
COM1>
```

logout	LogOut									

Use this command to return to anonymous access. It is the reverse of **login**.

Example

The following sequence of commands logs in as user "admin" with password "admin", reconfigures SBF output, and logs out again:

```
COM1> login, admin, admin <CR>
$R! LogIn
    User admin logged in.
COM1> sso, Stream1, COM1, PVTCartesian, sec1 <CR>
$R: sso, Stream1, COM1, PVTCartesian, sec1
    SBFOutput, Stream1, COM1, PVTCartesian, sec1
COM1> logout <CR>
$R! LogOut
    User admin logged out.
COM1>
```

sual gual	setUserAccessLevel getUserAccessLevel	UserID UserID	UserName (16)	Password (32)	UserLevel	SSHKey (232)				
		+ User1 ... User8 all			Viewer User					

RxControl: File > User Management

Use these commands to manage the user accounts and their access rights on the receiver. Up to eight user accounts can be defined (User1 to User8).

Each user is identified with a *UserName* and *Password*, and has a certain level of access (*UserLevel*). If *UserLevel* is `User`, the user has full control of the receiver. If it is `Viewer`, the user can only issue **get**-commands.

The *SSHKey* argument can be used to associate an SSH public key to a user. RSA and ECDSA PEM-encoded (base64) public keys conforming to RFC 4716 are supported. The number of bits in the key must be such that the corresponding base64 public key does not exceed 232 characters. RSA keys need to be at least 1024 bits long. Whenever possible, using the 521-bit ECDSA key is recommended for enhanced security. The corresponding base64 public key is a 232-character string.

When an SSH key is defined with the *SSHKey* argument, a user can download log files using SFTP or `rsync` without the need for entering a password, provided the matching private key is known by the key agent running on his machine.

To delete an user account, use the empty string "" as *UserName* and *Password*.

Note that the receiver encrypts the password so that it cannot be read back with the command **getUserAccessLevel**.

Example

```
COM1> sual, User3, Mildred, mypwd, Viewer, AAAAE2VjZH ...
a9YSdPMw==<CR>
$R: sual, User3, Mildred, mypwd, Viewer, AAAAE2VjZH ... a9YSdPMw==
UserAccessLevel, User3, Mildred, mypwd, Viewer, AAAAE2VjZH ...
a9YSdPMw==
COM1>
```

3.2.4 Tracking and Measurement Generation

sca	setChannelAllocation	Channel	Satellite	Search	Doppler	Window				
gca	getChannelAllocation	Channel								
		+ Ch01 ... Ch60 all	auto G01 ... G32 F01 ... F14 E01 ... E36 S120 ... S158 C01 ... C63 J01 ... J07 I01 ... I14	auto manual	-50000 ... 0 ... 50000 Hz	1 ... 16000 ... 100000 Hz				

[RxControl: Navigation > Advanced User Settings > Channel Allocation](#)

Use these commands to define/inquire the satellite-to-channel allocation of the receiver.

The action of the **setChannelAllocation** command is to force the allocation of a particular satellite on the set of channels identified with the *Channel* argument, thereby overruling the automatic channel allocation performed by the receiver. It is possible to allocate the same satellite to more than one channel. If you assign a satellite to a given channel, any other channel that was automatically allocated to the same satellite will be stopped and will be reallocated.

The values *Gxx*, *Exx*, *Fxx*, *Cxx*, *Ixx*, *Jxx* and *Sxxx* for the *Satellite* argument represent GPS, Galileo, GLONASS, BeiDou, NavIC/IRNSS, QZSS and SBAS satellites respectively. For GLONASS, the frequency number (with an offset of 8) should be provided, and not the slot number (hence the "F"). Setting the *Satellite* argument to `auto` brings the channel back in auto-allocation mode.

The user can specify the Doppler window in which the receiver has to search for the satellite. This is done by setting the *Search* argument to `manual`. In that case, the *Doppler* and *Window* arguments can be provided: the receiver will search for the signal within an interval of *Window* Hz centred on *Doppler* Hz. The value to be provided in the *Doppler* argument is the expected Doppler at the GPS L1 carrier frequency (1575.42MHz). This value includes the geometric Doppler and the receiver and satellite frequency biases. Specifying a Doppler window can speed up the search process in some circumstances. A satellite already in tracking that falls outside of the prescribed window will remain in tracking.

If *Search* is set to `auto`, the receiver applies its usual search procedure, as it would do for auto-allocated satellites, and the *Doppler* and *Window* arguments are ignored.

Be aware that this command may disturb the normal operation of the receiver and is intended only for expert-level users.

Examples

```
COM1> sca, Ch05, G01 <CR>
$R: sca, Ch05, G01
    ChannelAllocation, Ch05, G01, auto, 0, 16000
COM1>
```

```
COM1> gca, Ch05 <CR>
$R: gca, Ch05
    ChannelAllocation, Ch05, G01, auto, 0, 16000
```

COM1>

scm	setCN0Mask	Signal	Mask						
gcm	getCN0Mask	Signal							
		+GPSL1CA	0...10...60 dB-Hz						
		+Reserved1							
		+Reserved2							
		+GPSL2C							
		+GPSL5							
		+GLOL1CA							
		+GLOL2P							
		+GLOL2CA							
		+GLOL3							
		+GALL1BC							
		+GALE5a							
		+GALE5b							
		+GALE5							
		+GEOL1							
		+GEOL5							
		+BDSB1I							
		+BDSB2I							
		+BDSB3I							
		+BDSB1C							
		+BDSB2a							
		+QZSL1CA							
		+QZSL2C							
		+QZSL5							
		+NAVICL5							
		all							

RxControl: Navigation > Receiver Operation > Masks

Use these commands to define/inquire the carrier-to-noise ratio mask for the generation of measurements. The receiver does not generate measurements for those signals of which the C/N_0 is under the specified mask, and does not include these signals in the PVT computation. However, it continues to track these signals and to decode and use the navigation data as long as possible, regardless of the C/N_0 mask.

The mask can be set independently for each of the signal types supported by the receiver, except for the GPS P-code, of which the mask is fixed at 1 dB-Hz (this is because of the codeless tracking scheme needed for GPS P-code).

Examples

```
COM1> scm, GEOL1, 30 <CR>
$R: scm, GEOL1, 30
    CN0Mask, GEOL1, 30
COM1>
```

```
COM1> gcm, GEOL1 <CR>
$R: gcm, GEOL1
    CN0Mask, GEOL1, 30
COM1>
```

smm	setMultipathMitigation	Code	Carrier							
gmm	getMultipathMitigation									
		off	off							
		on	on							

[RxControl: Navigation > Receiver Operation > Tracking and Measurements > Multipath](#)

Use these commands to define/inquire whether multipath mitigation is enabled or not.

The arguments *Code* and *Carrier* enable or disable the A-Posteriori Multipath Estimator (APME) for the code and carrier phase measurements respectively. APME is a technique by which the receiver continuously estimates the multipath error and corrects the measurements accordingly.

This multipath estimation process slightly increases the thermal noise on the pseudoranges. However, this increase is more than compensated by the dramatic decrease of the multipath noise.

Examples

```
COM1> smm, on, off <CR>
$R: smm, on, off
  MultipathMitigation, on, off
COM1>
```

```
COM1> gmm <CR>
$R: gmm
  MultipathMitigation, on, off
COM1>
```

sst	setSatelliteTracking	Satellite							
gst	getSatelliteTracking								
		none +G01 ... G32 +R01 ... R30 +E01 ... E36 +S120 ... S158 +C01 ... C37 +C38 ... C63 +J01 ... J07 +I01 ... I14 +GPS +GLONASS +GALILEO +SBAS +BEIDOU +QZSS +NAVIC all							

[RxControl: Navigation > Advanced User Settings > Tracking > Satellite Tracking](#)

Use these commands to define/inquire which satellites are allowed to be tracked by the receiver. It is possible to enable or disable a single satellite (e.g. G01 for GPS PRN1), or a whole constellation. Gxx, Exx, Rxx, Cxx, Ixx, Jxx and Sxxx refer to a GPS, Galileo, GLONASS, BeiDou, NavIC/IRNSS, QZSS or SBAS satellite respectively. GLONASS satellites must be referenced by their slot number in this command.

For a satellite to be effectively tracked by the receiver, make sure that at least one of its signals is enabled in the **setSignalTracking** command.

A satellite which is disabled by this command is not considered anymore in the automatic channel allocation mechanism, but it can still be forced to a given channel, and tracked, using the **setChannelAllocation** command.

Tracking a satellite does not automatically mean that the satellite will be included in the PVT computation. The inclusion of a satellite in the PVT computation is controlled by the **setSatelliteUsage** command.

Examples

To only enable the tracking of GPS satellites, use:

```
COM1> sst, GPS <CR>
$R: sst, GPS
  SatelliteTracking, G01+G02+G03+G04+G05+G06+G07+G08+G09+G10+G11
  +G12+G13+G14+G15+G16+G17+G18+G19+G20+G21+G22+G23+G24+G25+G26+G27
  +G28+G29+G30+G31+G32
COM1>
```

To add all SBAS satellites in the list of satellites to be tracked, use:

```
COM1> sst, +SBAS <CR>
$R: sst, +SBAS
  SatelliteTracking, G01+G02+G03+G04+G05+G06+G07+G08+G09+G10+G11
  +G12+G13+G14+G15+G16+G17+G18+G19+G20+G21+G22+G23+G24+G25+G26+G27
  ...
COM1>
```

To remove SBAS PRN120 from the list of allowed satellites, use:

```
COM1> sst, -S120 <CR>
$R: sst, -S120
  SatelliteTracking, G01+G02+G03+G04+G05+G06+G07+G08+G09+G10+G11
  +G12+G13+G14+G15+G16+G17+G18+G19+G20+G21+G22+G23+G24+G25+G26+G27
  ...
COM1>
```

snt gnt	setSignalTracking getSignalTracking	Signal								
		+GPSL1CA +GPSL1PY +GPSL2PY +GPSL2C +GPSL5 +GLOL1CA +GLOL2P +GLOL2CA +GLOL3 +GALL1BC +GALE5a +GALE5b +GALE5 +GEOL1 +GEOL5 +BDSB1I +BDSB2I +BDSB3I +BDSB1C +BDSB2a +QZSL1CA +QZSL2C +QZSL5 +NAVICL5 +GPS +GLONASS +GALILEO +SBAS +BEIDOU +QZSS +NAVIC all								

RxControl: Navigation > Advanced User Settings > Tracking > Signal Tracking

Use these commands to define/inquire which signals are allowed to be tracked by the receiver. The signals can be addressed individually, or all signals from a constellation can be addressed at once. For example, `GALILEO` is an alias for all Galileo signals.

Note that some signals can only be enabled together with other signals:

- enabling `GPSL1PY` has no effect unless `GPSL1CA` and `GPSL2PY` are enabled as well;
- enabling `GPSL2PY` has no effect unless `GPSL1CA` is enabled as well;
- enabling `GLOL2P` has no effect unless `GLOL2CA` is enabled as well;
- enabling `GLOL3` has no effect unless `GLOL1CA` is enabled as well;

Invoking this command causes all tracking loops to stop and restart.

Examples

To configure the receiver in a single-frequency L1 GPS+SBAS mode, use:

```
COM1> snt, GPSL1CA+GEOL1 <CR>
$R: snt, GPSL1CA+GEOL1
    SignalTracking, GPSL1CA+GEOL1
COM1>
```

```
COM1> gnt <CR>
$R: gnt
    SignalTracking, GPSL1CA+GEOL1
```

COM1>

ssi gsi	setSmoothingInterval getSmoothingInterval	Signal Signal	Interval	Alignment					
		+GPSL1CA +GPSL2PY +GPSL2C +GPSL5 +GLOL1CA +GLOL2P +GLOL2CA +GLOL3 +GALL1BC +GALE5a +GALE5b +GALE5 +GEOL1 +GEOL5 +BDSB1I +BDSB2I +BDSB3I +BDSB1C +BDSB2a +QZSL1CA +QZSL2C +QZSL5 +NAVICL5 all	0...1000 s	0...1000 s					

[RxControl: Navigation > Receiver Operation > Tracking and Measurements > Smoothing](#)

Use these commands to define/inquire the code measurement smoothing interval.

The *Interval* argument defines the length of the smoothing filter that is used to smooth the code measurements by the carrier phase measurements. It is possible to define a different interval for each signal type. If *Interval* is set to 0, the code measurements are not smoothed. The smoothing interval can vary from 1 to 1000 seconds.

To prevent transient effect from perturbing the smoothing filter, smoothing is disabled during the first ten seconds of tracking, i.e. when the lock time is lower than 10s. Likewise, the smoothing effectively starts with a delay of 10 seconds after entering the **setSmoothingInterval** command.

Code smoothing allows reducing the pseudorange noise and multipath. It has no influence on the carrier phase and Doppler measurements. The smoothing filter has an incremental effect; the noise of the filtered pseudorange will decrease over time and reach its minimum after *Interval* seconds. For some applications, it may be necessary to wait until this transient effect is over before including the measurement in the PVT computation. This is the purpose of the *Alignment* argument. If *Alignment* is not set to 0, measurements taken during the first *Alignment*+10 seconds of tracking will be discarded. The effective amount of *Alignment* is never larger than *Interval*, even if the user sets it to a larger value.

Examples

```
COM1> ssi, GPSL1CA, 300 <CR>
$R: ssi, GPSL1CA, 300
    SmoothingInterval, GPSL1CA, 300, 0
COM1>
```

```
COM1> gsi, GPSL1CA <CR>
$R: gsi, GPSL1CA
```

```
SmoothingInterval, GPSL1CA, 300, 0  
COM1>
```

stlp gtlp	setTrackingLoopParameters getTrackingLoopParameters	Signal Signal	DLLBandwidth	PLLBandwidth	MaxTpDLL	MaxTpPLL	Adaptive			
		+ GPSL1CA + Reserved1 + Reserved2 + GPSL2C + GPSL5 + GLOL1CA + GLOL2P + GLOL2CA + GLOL3 + GALL1BC + GALE5a + GALE5b + GALE5 + GEOL1 + GEOL5 + BDSB1I + BDSB2I + BDSB3I + BDSB1C + BDSB2a + QZSL1CA + QZSL2C + QZSL5 + NAVICL5 all	0.01 ... 0.25 ... 5.00 Hz	1 ... 15 ... 100 Hz	1 ... 100 ... 500 ms	1 ... 10 ... 200 ms	off on			

[RxControl: Navigation > Advanced User Settings > Tracking > Tracking Loop Parameters](#)

Use these commands to define/inquire the tracking loop parameters for each individual signal type.

The *DLLBandwidth* and *PLLBandwidth* arguments define the single-sided DLL and PLL noise bandwidth, in Hz.

The *MaxTpDLL* argument defines the maximum DLL pre-detection time, in millisecond. The actual pre-detection time applied by the receiver (*TpDLL*) depends on the presence of a pilot component. For signals having a pilot component (e.g. GPS L2C), *TpDLL* = *MaxTpDLL*. For signals without pilot component (e.g. GPS L1CA), *TpDLL* is the largest divider of the symbol duration smaller than or equal to *MaxTpDLL*.

The *MaxTpPLL* argument defines the maximal PLL pre-detection time, in millisecond. The actual pre-detection time in the receiver (*TpPLL*) is computed in the same way as indicated for the *MaxTpDLL* argument.

Setting the *Adaptive* argument to `on` allows the receiver to dynamically change the loop parameters in order to optimize performance in specific conditions.

After entering this command, all active tracking loops stop and restart with the new settings.

This command should only be used by expert users who understand the consequences of modifying the default values. In some circumstances, changing the tracking parameters may result in the impossibility for the receiver to track a specific signal, or may significantly increase the processor load. It is recommended that the product of *TpPLL* (in milliseconds) and *PLLBandwidth* (in Hz) be kept between 100 and 200.

Note that decreasing the predetection times increases the load on the processor.

Example

```
COM1> stlp, GPSL1CA, 0.20, 12, , , off <CR>  
$R: stlp, GPSL1CA, 0.20, 12, , , off  
    TrackingLoopParameters, GPSL1CA, 0.20, 12, 100, 10, off  
COM1>
```

3.2.5 Frontend and Interference Mitigation

sam gam	setAGCMode getAGCMode	Band Band	Mode	Gain						
		+ L1 + L2 + L5 + LBand all	auto frozen manual	0 ... 35 ... 70 dB						

[RxControl: Navigation > Advanced User Settings > Frontend and Interference Mitigation > Frontend Settings](#)

Use these commands to define/inquire the operation mode of the Automatic Gain Control (AGC) in the receiver frontend. The AGC is responsible for amplifying the input RF signal to an appropriate level.

By default (*Mode* is set to `auto`), the AGC automatically adjusts its gain in function of the input signal power. In `frozen` mode, the AGC gain is kept constant at its current value (after a ten-second stabilisation period) and does not follow any subsequent variation of the input signal power. In `manual` mode, the user can set the gain to a fixed value specified by the *Gain* argument. The *Gain* argument is ignored in `auto` and `frozen` modes.

The first argument (*Band*) specifies for which frequency band the settings apply.

Example

```
COM1> sam, all, frozen <CR>
$R: sam, all, frozen
    AGCMode, L1, frozen, 30
COM1>
```

sbbs	setBBSamplingMode	<i>Mode</i>								
gbbs	getBBSamplingMode									
		BeforeIM								
		AfterIM								

[RxControl: Navigation > Advanced User Settings > Frontend and Interference Mitigation > Frontend Settings](#)

Use this command to configure the baseband samples (ADC samples) logged in the `BBSamples` SBF block.

The following sampling modes are defined:

Mode	Description
BeforeIM	The samples in the <code>BBSamples</code> SBF block are taken before interference mitigation (see the setNotchFiltering command). All frequency bands are sampled in turn.
AfterIM	The samples in the <code>BBSamples</code> SBF block are taken after interference mitigation (see the setNotchFiltering command). All frequency bands are sampled in turn.

Example

```
COM1> sbbs, BeforeIM <CR>
$R: sbbs, BeforeIM
    BBSamplingMode, BeforeIM
COM1>
```

snf gnf	setNotchFiltering getNotchFiltering	Notch Notch	Mode	CenterFreq	Bandwidth					
		+ Notch1 + Notch2 + Notch3 all	auto off manual	1100.000 ... 1700.000 MHz	30 ... 1600 kHz					

[RxControl: Navigation > Advanced User Settings > Frontend and Interference Mitigation > Frontend Settings](#)

Use these commands to set the position of the notch filter(s) in the receiver's frontend. Notch filters are used to cancel narrowband interferences.

The *Mode* argument is used to enable or disable the notch filter specified in the first argument. When set to `auto`, the receiver performs automatic detection of the region of the spectrum affected by interference if any. In `manual` mode, the user forces a certain region of the spectrum to be blanked by the notch filter. That region must be specified by the arguments *CenterFreq* and *Bandwidth*. *Bandwidth* is the double-sided bandwidth centered at *CenterFreq*. Specifying a region outside of a GNSS band has no effect.

In some cases, changing the operating mode of the notch filters (i.e. modifying the *Mode* argument) can cause the tracking loops to reset.

Example

```
COM1> snf, Notch1, manual, 1227.0, 30<CR>
$R: snf, Notch1, manual, 1227.0, 30
    NotchFiltering, Notch1, manual, 1227.000, 30
COM1>
```

swbi	setWBIMitigation	Mode								
gwbi	getWBIMitigation									
		off								
		on								

RxControl: Navigation > Advanced User Settings > Frontend and Interference Mitigation > Frontend Settings

Use this command to enable or disable the mitigation of wideband interferences, including swept-frequency or pulsed interferences. When enabled (argument *Mode* set to `on`), the interference mitigation is done automatically and can be monitored with the `RFStatus SBF` block.

Invoking this command causes all tracking loops to stop and restart.

Example

```
COM1> swbi, off<CR>
$R: swbi, off
    WBIMitigation, off
COM1>
```

3.2.6 Navigation Filter

sao	setAntennaOffset	Antenna	DeltaE	DeltaN	DeltaU	Type (20)	SerialNr (20)	SetupID		
gao	getAntennaOffset	Antenna								
		+ Main	-1000.0000	-1000.0000	-1000.0000	Unknown	Unknown	0...255		
		all	... 0.0000	... 0.0000	... 0.0000					
			... 1000.0000 m	... 1000.0000 m	... 1000.0000 m					

[RxControl: Navigation > Receiver Setup > Antennas](#)

Use these commands to define/inquire the parameters that are associated with the antenna connected to your receiver.

The arguments *DeltaE*, *DeltaN* and *DeltaU* are the offsets of the antenna reference point (ARP, see section 2.5) with respect to the marker, in the East, North and Up (ENU) directions respectively, expressed in meters. All absolute positions reported by the receiver are marker positions, obtained by subtracting this offset from the ARP. The purpose is to take into account the fact that the antenna may not be located directly on the surveying point of interest.

Use the argument *Type* to specify the type of your antenna. For best positional accuracy, it is recommended to select a type from the list returned by the command **lstAntennaInfo, Overview**. This is the list of antennas for which the receiver can compensate for phase center variation (see section 2.5). If *Type* does not match any entry in the list returned by **lstAntennaInfo, Overview**, the receiver will assume that the phase center variation is zero at all elevations and frequency bands, and the position will not be as accurate. If the antenna name contains whitespaces, it has to be enclosed between double quotes. For proper name matching, it is important to keep the exact same number of whitespaces and the same case as the name returned by **lstAntennaInfo, Overview**.

The argument *SerialNr* is the serial number of your particular antenna. It may contain letters as well as digits (do not forget to enclose the string between double quotes if it contains whitespaces).

The argument *SetupID* is the antenna setup ID as defined in the RTCM standard. It is a parameter for use by the service provider to indicate the particular reference station-antenna combination. The number should be increased whenever a change occurs at the station that affects the antenna phase center variations. Setting *SetupID* to zero means that the values of a standard model type calibration should be used. The value entered for this argument is used to set the setup ID field in the message type 23 of RTCM2.3, and in message types 1007, 1008 and 1033 of RTCM3. It has otherwise no effect on the receiver operation.

Example

```
COM1> sao, Main, 0.1, 0.0, 1.3, "AERAT2775_159 SPKE", 5684, 0<CR>
$R: sao, Main, 0.1, 0.0, 1.3, "AERAT2775_159 SPKE", 5684, 0
      AntennaOffset, Main, 0.1000, 0.0000, 1.3000, "AERAT2775_159
      SPKE", 5684, 0
COM1>
```

sdca gdca	setDiffCorrMaxAge getDiffCorrMaxAge	DGPSCorr	RTKCorr	PPPCorr	Iono					
		0.0 ... 400.0 ... 3600.0 s	0.0 ... 20.0 ... 3600.0 s	0.0 ... 0.0 s	0.0 ... 600.0 ... 3600.0 s					

[RxControl: Navigation > Positioning Mode > Differential Corrections](#)

Use these commands to define/inquire the maximum age acceptable for a given differential correction type. A correction is applied only if its age (aka latency) is under the timeout specified with this command and if it is also under the timeout specified with the *MaxAge* argument of the **setDiffCorrUsage** command. In other words, the command **setDiffCorrUsage** sets a global maximum timeout value, while the command **setDiffCorrMaxAge** can force shorter timeout values for certain correction types.

The argument *DGPSCorr* defines the timeout of the range corrections when the PVT is computed in DGPS mode.

The argument *RTKCorr* defines the timeout of the base station code and carrier phase measurements when the PVT is computed in RTK mode.

The argument *PPPCorr* defines the timeout of the wide-area satellite clock and orbit corrections used in PPP mode (only applicable if your receiver supports PPP positioning mode).

The argument *Iono* defines the timeout of the ionospheric corrections (such as transmitted in RTCM2.x MT15) used in DGPS PVT mode.

If the timeout is set to 0, the receiver will never apply the corresponding correction.

Note that this command does not apply to the corrections transmitted by SBAS satellites. For these corrections, the receiver always applies the timeout values prescribed in the DO229 standard.

Example

```
COM1> sdca, 10 <CR>
$R: sdca, 10
    DiffCorrMaxAge, 10.0, 20.0, 300.0, 300.0
COM1>
```

sdcu gdcu	setDiffCorrUsage getDiffCorrUsage	Mode	MaxAge	BaseSelection	BaseID	MovingBase	MaxBase	MaxBaseline		
		LowLatency	0.1 ... 3600.0 s	auto manual	0 ... 4095	off on	1 ... 10	0 ... 2500000 m		

[RxControl: Navigation > Positioning Mode > Differential Corrections](#)

Use these commands to define/inquire the usage of incoming differential corrections in DGPS or RTK rover mode.

The *Mode* argument defines the type of differential solution that will be computed by the receiver. If `LowLatency` is selected, the PVT is computed at the moment local measurements of the receiver are available and the most recently received differential corrections are extrapolated to the current time.

The *MaxAge* argument defines the maximum age of the differential corrections to be considered valid. *MaxAge* applies to all types of corrections (DGPS, RTK, satellite orbit, etc), except for those received from a SBAS satellite. See also the command **setDiffCorrMaxAge** to set different maximum ages for different correction types.

The *BaseSelection* argument defines how the receiver should select the base station(s) to be used. If `auto` is selected and the receiver is in DGPS-rover mode, it will use all available base stations. If `auto` is selected and the receiver is in RTK-rover mode, it will automatically select the nearest base station. If `manual` is selected, the receiver will only use the corrections from the base station defined by the *BaseID* argument (in both DGPS and RTK modes).

The *MovingBase* argument defines whether the base station is static or moving.

MaxBase sets the maximum number of base stations to include in the PVT solution.

MaxBaseline sets the maximum baseline length: base stations located beyond the maximum baseline length are excluded from the PVT solution.

Example

```
COM1> sdcu, LowLatency, 5.0, manual, 1011, off, 1, 10000<CR>
$R: sdcu, LowLatency, 5.0, manual, 1011, off, 1, 10000
  DiffCorrUsage, LowLatency, 5.0, manual, 1011, off, 1, 10000
COM1>
```

sem gem	setElevationMask getElevationMask	Engine Engine	Mask							
		+ Tracking + PVT all	-90 ... 0 ... 90 deg							

RxControl: Navigation > Receiver Operation > Masks

Use these commands to set or get the elevation mask in degrees. There are two masks defined: a tracking mask and a PVT mask.

Satellites under the tracking elevation mask are not tracked, and therefore there is no measurement, nor navigation data available from them. The tracking elevation mask does not apply to SBAS satellites: SBAS satellites are generally used to supply corrections and it is undesirable to make the availability of SBAS corrections dependent on the satellite elevation. The tracking elevation mask does not apply to satellites that are manually assigned with the **setChannelAllocation** command.

Satellite under the PVT mask are not included in the PVT solution, though they still provide measurements and their navigation data is still decoded and used. The PVT elevation mask do apply to the SBAS satellites: the ranges to SBAS satellites under the elevation mask are not used in the PVT, but the SBAS corrections are still decoded and potentially used in the PVT.

Although possible, it does not make sense to select a higher elevation mask for the tracking than for the PVT, as, obviously, a satellite which is not tracked cannot be included in the PVT.

The mask can be negative to allow the receiver to track satellites below the horizon. This can happen in case the receiver is located at high altitudes or if the signal is refracted through the atmosphere.

Example

```
COM1> sem, PVT, 15<CR>
$R: sem, PVT, 15
    ElevationMask, PVT, 15
COM1>
```

sgu ggu	setGeoidUndulation getGeoidUndulation	Mode	Undulation							
		auto manual	-250.000 ... 0.000 ...250.000 m							

RxControl: Navigation > Receiver Operation > Position > Earth Models

Use these commands to define/inquire the geoid undulation at the receiver position. The geoid undulation specifies the local difference between the geoid and the WGS84 ellipsoid.

If *Mode* is set to `auto`, the receiver computes the geoid undulation with respect to the WGS84 ellipsoid using the model defined in 'Technical Characteristics of the NAVSTAR GPS, NATO, June 1991', regardless of the datum specified with the `setGeodeticDatum` command. In `auto` mode, the *Undulation* argument is ignored.

The geoid undulation is included in the `PVTCartesian` and the `PVTGeodetic` SBF blocks and in the NMEA position messages.

Examples

```
COM1> sgu, manual, 25.3 <CR>
$R: sgu, manual, 25.3
    GeoidUndulation, manual, 25.3
COM1>
```

```
COM1> ggu <CR>
$R: ggu
    GeoidUndulation, manual, 25.3
COM1>
```

shm ghm	setHealthMask getHealthMask	Engine Engine	Mask							
		+ Tracking + PVT all	off on							

[RxControl: Navigation > Receiver Operation > Masks](#)

Use these commands to define/inquire whether measurements should be produced for unhealthy satellite signals, and whether these measurements should be included in the PVT solution. All satellite signals of which the health is unknown to the receiver (because the health information has not been decoded yet or is not transmitted) are considered healthy.

If *Mask* is `on` for the `Tracking` engine, no measurements are generated for unhealthy signals, but these signals will remain internally tracked and their navigation data will be decoded and processed. This is to ensure immediate reaction in the event that the signal would become healthy again.

If *Mask* is `on` for the `PVT` engine, measurements from unhealthy signals are not included in the PVT. Setting this mask to `off` must be done with caution: including a non-healthy signal in the PVT computation may lead to unpredictable behaviour of the receiver.

Although possible, it does not make sense to enable unhealthy satellites for the PVT if they are disabled for tracking.

Examples

To track unhealthy satellites/signals, use:

```
COM1> shm, Tracking, off <CR>
$R: shm, Tracking, off
    HealthMask, Tracking, off
COM1>
```

```
COM1> ghm <CR>
$R: ghm
    HealthMask, Tracking, off
    HealthMask, PVT, on
COM1>
```

sim	setIonosphereModel	Model								
gim	getIonosphereModel	Model								
		auto off Klobuchar SBAS MultiFreq KlobucharBeiDou								

[RxControl: Navigation > Receiver Operation > Position > Atmosphere](#)

Use these commands to define/inquire the type of model used to correct ionospheric errors in the PVT computation. The following models are available:

Model	Description
auto	With this selection, the receiver will, based on the available information, automatically select the best model on a satellite to satellite basis.
off	The receiver will not correct measurements for the ionospheric delay. This may be desirable if the receiver is connected to a GNSS signal simulator.
Klobuchar	This model uses the parameters as transmitted by the GPS satellites to compute the ionospheric delays.
SBAS	This model complies with the DO229 standard: it uses the near real-time ionospheric delays transmitted by the SBAS satellites in MT18 and MT26. If no such message has been received, the Klobuchar model is selected automatically.
MultiFreq	This model uses a combination of measurements on different carriers to accurately estimate ionospheric delays. It requires the availability of at least dual-frequency measurements.
KlobucharBeiDou	This model uses the parameters as transmitted by the BeiDou satellites to compute the ionospheric delays.

Unless the model is set to `auto`, the receiver uses the same model for all satellites, e.g. if the `Klobuchar` model is requested, the Klobuchar parameters transmitted by GPS satellites are used for all tracked satellites, regardless of their constellation.

If not enough data is available to apply the prescribed model to a given satellite (for instance if only single-frequency measurements are available and the model is set to `MultiFreq`), the satellite in question will be discarded from the PVT. Under most circumstances, it is recommended to leave the model to `auto`.

Examples

To disable the compensation for ionospheric delays, use:

```
COM1> sim, off <CR>
$R: sim, off
  IonosphereModel, off
COM1>
```

```
COM1> gim <CR>
$R: gim
```

```
IonosphereModel, off  
COM1>
```

smv gmv	setMagneticVariance getMagneticVariance	Mode	Variance							
		auto manual	-180.0...0.0 ...180.0 deg							

[RxControl: Navigation > Receiver Operation > Position > Earth Models](#)

Use these commands to define the magnetic variance (a.k.a. magnetic declination) at the current position. The magnetic variance specifies the local offset of the direction to the magnetic north with respect to the geographic north. The variance is positive when the magnetic north is east of the geographic north.

By default (the argument *Mode* is set to `auto`), the receiver automatically computes the variance according to the 12th generation of the International Geomagnetic Reference Field (IGRF) model, using the IGRF2015 coefficients corrected for the secular variation.

Note that the magnetic variance is used solely in the generation of NMEA messages.

Examples

```
COM1> smv, manual, 1.1 <CR>
$R: smv, manual, 1.1
  MagneticVariance, manual, 1.1
COM1>
```

```
COM1> gmv <CR>
$R: gmv
  MagneticVariance, manual, 1.1
COM1>
```

snrc	setNetworkRTKConfig	<i>NetworkType</i>								
gnrc	getNetworkRTKConfig									
		auto								
		VRS								

RxControl: Navigation > Positioning Mode > Differential Corrections

Use these commands to define/inquire the type of the RTK network providing the differential corrections.

In most cases, it is recommended to leave the *Type* argument to `auto` to let the receiver autodetect the network type. For some types of VRS networks (especially for those having long baselines between the base stations), optimal performance is obtained by forcing the type to `VRS`.

Example

```
COM1> snrc, VRS <CR>
$R: snrc, VRS
    NetworkRTKConfig, VRS
COM1>
```

spm gpm	setPVTMode getPVTMode	Mode	RoverMode	RefPos						
		Static Rover	+ StandAlone + SBAS + DGPS + RTKFloat + RTKFixed + RTK all	auto Geodetic1 Geodetic2 Geodetic3 Geodetic4 Geodetic5 Cartesian1 Cartesian2 Cartesian3 Cartesian4 Cartesian5						

[RxControl: Navigation > Positioning Mode > PVT Mode](#)

Use these commands to define/inquire the main PVT mode of the receiver. The argument *Mode* specifies the general positioning mode. If *Rover* is selected, the receiver assumes that it is moving and it computes the best PVT allowed by the *RoverMode* argument. If *Static* is selected, the receiver assumes that it is static and it reports a constant position. The static position can be specified by the user or computed by the receiver, according to the settings of the *RefPos* argument.

The argument *RoverMode* specifies the allowed PVT modes when the receiver is operating in *Rover* mode. Different modes can be combined with the "+" operator. Refer to section 2.4 for a description of the PVT modes. The value *RTK* is an alias for *RTKFloat+RTKFixed*. When more than one mode is enabled in *RoverMode*, the receiver automatically selects the mode that provides the most accurate solution with the available data.

The *RefPos* argument defines the reference position of the antenna ARP. This is the position that is encoded in the RINEX header (after application of the marker-ARP offset specified with the **setAntennaOffset** command) and in the relevant RTCM and CMR differential correction messages.

If *RefPos* is set to *Geodetic*i** or *Cartesian*i**, the fixed ARP coordinates must be provided by the user with the **setStaticPosCartesian** or the **setStaticPosGeodetic** commands.

If *RefPos* is set to *auto*, the reference ARP position is computed by the receiver. In *rover* mode, the reference position is not fixed. This is the setting that must be used on moving platforms.

Examples

```
COM1> spm, Rover, StandAlone+RTK <CR>
$R: spm, Rover, StandAlone+RTK
    PVTMode, Rover, StandAlone+RTK, auto
COM1>
```

To set up a fixed base station at a known location, use the following:

```
COM1> sspg, Geodetic1, 50.5209, 4.4245, 113.3 <CR>
$R: sspg, Geodetic1, 50.5209, 4.4245, 113.3
    StaticPosGeodetic, Geodetic1, 50.52090000, 4.42450000, 113.3000
COM1> spm, Static, , Geodetic1 <CR>
$R: spm, Static, , Geodetic1
```

```
PVTMode, Static, StandAlone+RTK, Geodetic1  
COM1>
```

srl grl	setRAIMLevels getRAIMLevels	Mode	Pfa	Pmd	Reliability					
		off on	-12... <u>4</u> ...-1	-12... <u>4</u> ...-1	-12... <u>3</u> ...-1					

RxControl: Navigation > Receiver Operation > Position > Integrity

Use these commands to define/inquire the parameters of the Receiver Autonomous Integrity Monitoring (RAIM) algorithm in rover PVT mode.

The *Mode* argument acts as an on/off switch: it determines whether RAIM is active or not.

The *Pfa* argument sets the probability of false alarm of the w-test used in the "identification" step of the RAIM algorithm. Increasing this parameter increases the integrity but may reduce the availability of the positional solution.

The *Pmd* argument sets the probability of missed detection, which the receiver uses to compute the Minimal Detectable Bias and hence the XERL values.

The *Reliability* argument sets the probability of false alarm of the Overall Model test used in the "detection" step of the RAIM algorithm.

The value to be provided in the *Pfa*, *Pmd* and *Reliability* arguments are the base-10 logarithms of the desired probabilities. For instance, if you want a probability of false alarm of 1e-6, you have to set the *Pfa* argument to -6.

Note that this command has no effect when the receiver is configured in static PVT mode with the **setPVTMode, Static** command. In static PVT mode, the RAIM algorithm uses fixed parameters that cannot be changed by the user.

Examples

To configure the receiver outlier detection with a probability of 1e-4 (0.01%) that a false alarm will be raised (type I error), a probability of 1e-4 (0.01%) that an outlier will be missed (type II error) and an Overall Model probability of false alarm of 1e-6 (0.0001%), use:

```
COM1> srl, on, -4, -4, -6 <CR>
$R: srl, on, -4, -4, -6
    RAIMLevels, on, -4, -4, -6
COM1>
```

To disable the outlier detection, use:

```
COM1> srl, off <CR>
$R: srl, off
    RAIMLevels, off, -4, -4, -6
COM1>
```

srd grd	setReceiverDynamics getReceiverDynamics	Level	Motion							
		Max High Moderate Low	Static Quasistatic Pedestrian Automotive RaceCar HeavyMachinery UAV Unlimited							

[RxControl: Navigation > Receiver Operation > Position > Motion](#)

Use these commands to set the type of dynamics the GNSS antenna is subjected to.

The *Level* argument sets the balance between noise and dynamics in the GNSS measurements and the PVT solution. If rapid displacements (such as those caused by shocks, drops, and oscillations) need to be detected, the *Level* argument can be set to `High`. In that case, high-frequency motion becomes visible at the expense of an increase in the noise. Conversely, if noise reduction is important, the *Level* argument can be set to `Low`. It is generally recommended to keep the default value (`Moderate`), where the receiver will sense the dynamics and adapt itself accordingly. The `Max` level is a special setting, for which the navigation filter is disabled and the receiver computes epoch-by-epoch independent PVT solutions. Note that the `Max` level can lead to a longer latency of the PVT output.

The *Motion* argument defines the general characteristics of the receiver motion, such as the expected speed, rotation, and vibration level. This can help the receiver to optimize certain parameters for your application.

For example, when selecting the `Pedestrian` motion, signal reacquisition will be faster after a long outage, as the position is known not to have changed much.

Motion	Description
Static	Fixed base and reference stations.
Quasistatic	Low speed, limited area motion typical of surveying applications.
Pedestrian	Low speed (<7m/s) motion. E.g. pedestrians, low-speed land vehicles, ...
Automotive	Medium speed (<50m/s) motion. E.g. passenger cars, rail vehicles. This setting is generally adequate for most applications.
RaceCar	High speed terrestrial vehicle. E.g. race cars, ...
HeavyMachinery	Construction equipment, tractors, ...
UAV	Unmanned Aerial Vehicle.
Unlimited	Unconstrained motion.

Example

```
COM1> srd, Max <CR>
$R: srd, Max
ReceiverDynamics, Max, Automotive
COM1>
```

ernf	exeResetNavFilter	<i>Level</i>								
grnf	getResetNavFilter									
		+ PVT + AmbRTK all								

RxControl: Navigation > Receiver Initialization > Reset Navigation Filter

Use this command to reset the different navigation filters in the receiver. The user can reset each navigation filter independently or together with the value `all`.

The following values for *Level* are defined:

Level	Description
PVT	Reset the whole PVT filter such that all previous positioning information is discarded, including the RTK ambiguities and the INS/GNSS integration filter when applicable.
AmbRTK	Only reset the ambiguities used in RTK positioning to float status.

Example

```
COM1> ernf, PVT <CR>
$R: ernf, PVT
    ResetNavFilter, PVT
COM1>
```

SSU GSU	setSatelliteUsage getSatelliteUsage	Satellite								
		none +G01 ... G32 +R01 ... R24 +R25 +R26 +R27 +R28 +R29 +R30 +E01 ... E36 +S120 ... S158 +C01 ... C63 +GPS +GLONASS +GALILEO +SBAS +BEIDOU all								

RxControl: Navigation > Advanced User Settings > PVT > Satellite Usage

Use these commands to define/inquire which satellites are allowed to be included in the PVT computation. It is possible to enable or disable a single satellite (e.g. G01 for GPS PRN1), or a whole constellation. Gxx, Exx, Rxx, Cxx and Sxxx refer to a GPS, Galileo, GLONASS, BeiDou and SBAS satellite respectively. GLONASS satellites must be referenced by their slot number in this command.

Examples

To only use GPS measurements in the PVT computation, use:

```
COM1> ssu, GPS <CR>
$R: ssu, GPS
    SatelliteUsage, G01+G02+G03+G04+G05+G06+G07+G08+G09+G10+G11
    +G12+G13+G14+G15+G16+G17+G18+G19+G20+G21+G22+G23+G24+G25+G26
    +G27+G28+G29+G30+G31+G32
COM1>
```

To add the usage of SBAS measurements in the PVT, use:

```
COM1> ssu, +SBAS <CR>
$R: ssu, +SBAS
    SatelliteUsage, G01+G02+G03+G04+G05+G06+G07+G08+G09+G10+G11
    +G12+G13+G14+G15+G16+G17+G18+G19+G20+G21+G22+G23+G24+G25+G26
    ...
COM1>
```

To remove the measurement of one satellite from the PVT, use:

```
COM1> ssu, -S120 <CR>
$R: ssu, -S120
    SatelliteUsage, G01+G02+G03+G04+G05+G06+G07+G08+G09+G10+G11
    +G12+G13+G14+G15+G16+G17+G18+G19+G20+G21+G22+G23+G24+G25+G26
    ...
CM1>
```

ssbc gsbc	setSBASCORRECTIONS getSBASCORRECTIONS	Satellite	SISMode	NavMode	DO229Version					
		auto EGNOS WAAS MSAS GAGAN SDCM S120 ... S158	Test Operational	EnRoute PrecApp MixedSystems	auto DO229C					

RxControl: Navigation > Positioning Mode > SBAS Corrections

Use these commands to define/inquire the details on the usage of SBAS data in the PVT computation. This command does not define whether SBAS corrections are to be used or not in the PVT (this is done by the **setPVTMode** command), but it specifies how these corrections should be used.

The *Satellite* argument defines the provider of SBAS corrections, being either an individual satellite or a satellite system. If EGNOS, WAAS, MSAS, GAGAN or SDCM is selected, the receiver restricts the automatic selection of a satellite to those that are part of the EGNOS, WAAS, MSAS, GAGAN or SDCM system. When `auto` is selected for the *Satellite* argument, the receiver will automatically select a satellite on the basis of the location of the receiver and on the availability of SBAS corrections.

The *SISMode* argument defines the interpretation of a "Do Not Use for Safety Applications" message.

When set to `Operational`, the receiver will discard all SBAS corrections received from a satellite upon reception of a MT00 from that satellite. Note that MT02 content encoded in a MT00 message will be interpreted by the receiver as a MT02 message: only MT00 with all '0' symbols will be interpreted as a true "Do Not Use for Safety Applications". When the argument *SISMode* is set to `Test`, the receiver will ignore the reception of a "Do Not Use for Safety Applications" message. This provides the possibility to use a signal from a SBAS system in test mode.

The SBAS standards, which have their origin in aviation, make a distinction between two positioning applications: en-route and precision approach. The choice between both applications influences the length of the interval during which the SBAS corrections are valid. During a precision approach the validity of the data is much shorter. The receiver can operate in both modes, which is controlled by the *NavMode* argument.

In `EnRoute` or in `PrecApp` mode, the receiver only uses the satellite systems for which SBAS corrections are available. For best positioning accuracy, it is typically preferable to include all satellites in the position computation, even if they are not corrected by SBAS. This is achieved by the `MixedSystems` mode.

The *DO229Version* argument can be used to specify which version of the DO 229 standard to conform to.

Example

To force the receiver to use corrections from PRN 122 and ignore message MT00:

```
COM1> ssbc, S122, Test <CR>
$R: ssbc, S122, Test
      SBASCORRECTIONS, S122, Test, MixedSystems, auto
```

COM1>

snu gnu	setSignalUsage getSignalUsage	PVT	NavData							
		+GPSL1CA +GPSL1PY +GPSL2PY +GPSL2C +GPSL5 +GLOL1CA +GLOL2P +GLOL2CA +GLOL3 +GALL1BC +GALE5a +GALE5b +GALE5 +GEOL1 +GEOL5 +BDSB1I +BDSB2I +BDSB3I +BDSB1C +BDSB2a all	+GPSL1CA +GPSL1PY +GPSL2PY +GPSL2C +GPSL5 +GLOL1CA +GLOL2P +GLOL2CA +GLOL3 +GALL1BC +GALE5a +GALE5b +GALE5 +GEOL1 +GEOL5 +BDSB1I +BDSB2I +BDSB3I +BDSB1C +BDSB2a +QZSL1CA +QZSL2C +QZSL5 all							

[RxControl: Navigation > Advanced User Settings > PVT > Signal Usage](#)

Use these commands to define/inquire which signal types are used by the receiver.

The *PVT* argument lists the signals that can be used by the PVT. Removing a signal from the list will disable the usage of the corresponding range, phase & Doppler measurements in the PVT computation.

The *NavData* argument lists the signals for which the receiver is allowed to decode the navigation message. Removing a signal from the list will disable the usage of the corresponding navigation information (ephemeris, ionosphere parameters ...).

Example

To force the receiver to only use the L1 GPS C/A measurements and navigation information in the PVT solution, use:

```
COM1> snu, GPSL1CA, GPSL1CA <CR>
$R: snu, GPSL1CA, GPSL1CA
    SignalUsage, GPSL1CA, GPSL1CA
COM1>
```

sspc gspc	setStaticPosCartesian getStaticPosCartesian	Position Position	X	Y	Z	Datum				
		+ Cartesian1	-8000000.0000	-8000000.0000	-8000000.0000	WGS84				
		+ Cartesian2	...0.0000	...0.0000	...0.0000	ETRS89				
		+ Cartesian3	...8000000.0000	...8000000.0000	...8000000.0000	NAD83				
		+ Cartesian4	m	m	m	NAD83_PA				
		+ Cartesian5				NAD83_MA				
		all				GDA94				
						GDA2020				
						User1				
						User2				
						Other				

RxControl: Navigation > Positioning Mode > PVT Mode

Use these commands to define/inquire a set of Cartesian coordinates. This command should be used in conjunction with the **setPVTMode** command to specify a reference position. The Cartesian coordinates in the X, Y and Z arguments must refer to the antenna reference point (ARP), and not to the marker.

The argument *Datum* specifies the datum to which the coordinates refer. When the PVT engine is in static mode (**setPVTMode**, **Static** command), the specified datum is reflected in the *Datum* field of the position-related SBF blocks (e.g. *PVTCartesian*). Note that the receiver does not apply any datum transformation to the X, Y and Z coordinates. In particular, the coordinates are encoded without change into the relevant differential correction messages.

Datum	Description
WGS84	WGS84 or ITRFxx (the receiver does not make a distinction between them)
ETRS89	European ETRS89 (ETRF2000 realization)
NAD83	NAD83(2011), North American Datum (2011)
NAD83_PA	NAD83(PA11), North American Datum, Pacific plate (2011)
NAD83_MA	NAD83(MA11), North American Datum, Marianas plate (2011)
GDA94	GDA94(2010), Geocentric Datum of Australia (2010)
GDA2020	GDA2020, Geocentric Datum of Australia 2020
User1	First user-defined datum. The corresponding ellipsoid must be defined with the setUserEllipsoid command.
User2	Second user-defined datum
Other	Datum not in the list or unknown

Example

To set up a static base station in Cartesian coordinates:

```
COM1> sspc, Cartesian1, 4019952.028, 331452.954, 4924307.458 <CR>
$R: sspc, Cartesian1, 4019952.028, 331452.954, 4924307.458
      StaticPosCartesian, Cartesian1, 4019952.0280, 331452.9540,
      4924307.4580, WGS84
COM1> spm, Static, , Cartesian1 <CR>
$R: spm, Static, , Cartesian1
```

```
PVTMode, Static, StandAlone+SBAS+DGPS+RTKFloat+RTKFixed,  
    Cartesian1  
COM1>
```

sspg gspg	setStaticPosGeodetic getStaticPosGeodetic	Position Position	Latitude	Longitude	Altitude	Datum				
		+ Geodetic1 + Geodetic2 + Geodetic3 + Geodetic4 + Geodetic5 all	-90.000000000 ... 0.000000000 ... 90.000000000 deg	-180.000000000 ... 0.000000000 ... 180.000000000 deg	-1000.0000 ... 0.0000 ... 30000.0000 m	WGS84 ETRS89 NAD83 NAD83_PA NAD83_MA GDA94 GDA2020 User1 User2 Other				

RxControl: Navigation > Positioning Mode > PVT Mode

Use these commands to define/inquire a set of geodetic coordinates. This command should be used in conjunction with the **setPVTMode** command to specify a reference position. The geodetic coordinates in the *Latitude*, *Longitude* and *Altitude* arguments must refer to the antenna reference point (ARP), and not to the marker.

The argument *Datum* specifies the datum to which the coordinates refer. See the **setStaticPosCartesian** command for a short description of the supported datums.

Example

To set up a static base station in geodetic coordinates:

```
COM1> sspg, Geodetic1, 50.86696443, 4.71347657, 114.880 <CR>
$R: sspg, Geodetic1, 50.86696443, 4.71347657, 114.880
    StaticPosGeodetic, Geodetic1, 50.86696443, 4.71347657, 114.8800,
    WGS84
COM1> spm, Static, , Geodetic1 <CR>
$R: spm, Static, , Geodetic1
    PVTMode, Static, StandAlone+SBAS+DGPS+RTKFloat+RTKFixed,
    Geodetic1
COM1>
```

stm gtm	setTroposphereModel getTroposphereModel	<i>ZenithModel</i>	<i>MappingModel</i>							
		off Saastamoinen MOPS	Niell MOPS							

RxControl: Navigation > Receiver Operation > Position > Atmosphere

Use these commands to define/inquire the type of model used to correct tropospheric errors in the PVT computation.

The *ZenithModel* parameter indicates which model the receiver uses to compute the dry and wet delays for radio signals at 90 degree elevation. The modelled zenith tropospheric delay depends on assumptions for the local air total pressure, the water vapour pressure and the mean temperature. The following zenith models are defined:

ZenithModel	Description
off	The measurements will not be corrected for the troposphere delay. This may be desirable if the receiver is connected to a GNSS signal simulator.
Saastamoinen	Saastamoinen, J. (1973). "Contributions to the theory of atmospheric refraction". In three parts. Bulletin Geodesique, No 105, pp. 279-298; No 106, pp. 383-397; No. 107, pp. 13-34.
MOPS	Minimum Operational Performance Standards for Global Positioning/Wide Area Augmentation System Airborne Equipment RTCA/DO-229C, November 28, 2001.

The *Saastamoinen* model uses user-provided values of air temperature, total air pressure referenced to the Mean Sea Level and relative humidity (see **setTroposphereParameters** command) and estimates actual values adjusted to the receiver height.

The MOPS model neglects the user-provided values and instead assumes a seasonal model for all the climatic parameters. Local tropospheric conditions are estimated based on the coordinates and time of the year.

The use of the *Saastamoinen* model can be recommended if external information on temperature, pressure, humidity is available. Otherwise it is advisable to rely on climate models.

The zenith delay is mapped to the current elevation for each satellite using the requested *MappingModel*. The following mapping models are defined:

MappingModel	Description
Niell	Niell, A.E. (1996). Global Mapping Functions for the atmosphere delay at radio wavelengths, Journal of Geophysical Research, Vol. 101, No. B2, pp. 3227-3246.
MOPS	Minimum Operational Performance Standards for Global Positioning/Wide Area Augmentation System Airborne Equipment RTCA/DO-229C, November 28, 2001.

```
COM1> stm, MOPS, MOPS <CR>  
$R: stm, MOPS, MOPS  
    TroposphereModel, MOPS, MOPS  
COM1>
```

```
COM1> gtm <CR>  
$R: gtm  
    TroposphereModel, MOPS, MOPS  
COM1>
```

stp	setTroposphereParameters	Temperature	Pressure	Humidity						
gtp	getTroposphereParameters									
		-100.0 ... 15.0 ... 100.0 degC	800.00 ... 1013.25 ... 1500.00 hPa	0 ... 50 ... 100 %						

[RxControl: Navigation > Receiver Operation > Position > Atmosphere](#)

Use these commands to define/inquire the climate parameters to be used when the zenith troposphere is estimated using the Saastamoinen model (see the **setTroposphereModel** command).

The troposphere model assumes the climate parameters to be valid for a receiver located at the Mean Sea Level (MSL). If you want to use your receiver with a weather station, you have to convert the measured *Temperature*, *Pressure* and *Humidity* to MSL.

Example

```
COM1> stp, 25, 1013, 60<CR>
$R: stp, 25, 1013, 60
  TroposphereParameters, 25.0, 1013.00, 60
COM1>
```

3.2.7 Attitude Determination

sal gal	setAntennaLocation getAntennaLocation	Antenna Antenna	Mode	DeltaX	DeltaY	DeltaZ				
		+ Base	auto	-1000.0000	-1000.0000	-1000.0000				
		all	manual	... 0.0000	... 0.0000	... 0.0000				
				... 1000.0000 m	... 1000.0000 m	... 1000.0000 m				

[RxControl: Navigation > Positioning Mode > GNSS Attitude](#)

Use this command to define/inquire the relative location of the antennas in the vehicle reference frame in the context of attitude determination. See appendix A for a description of the vehicle reference frame.

The attitude of a vehicle (more precisely the heading and pitch angles) can be determined from the orientation of the baseline between two antennas attached to the vehicle. These two antennas must be connected to two receivers configured in moving-base RTK operation. Use the command **setGNSSAttitude** to enable attitude determination.

In moving-base attitude, **setAntennaLocation** should be invoked at the rover receiver with the *Antenna* argument set to `Base` to specify the relative position of the base antenna with respect to the rover antenna.

In `auto` mode, the receiver determines the attitude angles assuming that the baseline between the antenna ARPs is parallel to the longitudinal axis of the vehicle, and that the base antenna is in front of the rover antenna (i.e. towards the direction of movement). The length of the baseline is automatically computed by the receiver, and the baseline may be flexible. The *DeltaX*, *DeltaY* and *DeltaZ* arguments are ignored in `auto` mode.

In `manual` mode, the user can specify the exact position of the base antenna with respect to the rover antenna in the vehicle reference frame. Selecting `manual` mode implies that the baseline is rigid. The *DeltaX*, *DeltaY* and *DeltaZ* coordinates are ARP-to-ARP.

Example

In the case of moving-base attitude determination, if the moving-base antenna is located one meter to the left of the rover antenna, and 10 cm below, you should use:

```
COM1> sal, Base, manual, 0, -1, 0.1 <CR>
$R: sal, Base, manual, 0, 1, 0.1
    AntennaLocation, Base, manual, 0.0000, -1.0000, 0.1000
COM1>
```

sto	setAttitudeOffset	<i>Heading</i>	<i>Pitch</i>							
gto	getAttitudeOffset									
		-360.000...0.000 ...360.000 deg	-90.000...0.000 ...90.000 deg							

[RxControl: Navigation > Positioning Mode > GNSS Attitude](#)

Use this command to specify the offsets that the receiver applies to the computed attitude angles.

The attitude of a vehicle can be determined from the orientation of the baseline between two antennas attached to the vehicle. By default, the receiver determines the attitude angles assuming that the baseline between the antenna ARPs is parallel to the longitudinal axis of the vehicle. Attitude biases appear when this is not the case. The user can use this command to provide the value of the biases, such that the receiver can compensate for them before outputting the attitude. The receiver subtracts the provided biases from the attitude angles before encoding them in NMEA or SBF.

Another way to avoid attitude biases is to provide the accurate position of the antennas in the vehicle reference frame. See the command **setAntennaLocation** for more details.

Example

```
COM1> sto, 93.2, -0.4<CR>
$R: sto, 93.2, -0.4
  AttitudeOffset, 93.200, -0.400
COM1>
```

sga	setGNSSAttitude	<i>Source</i>								
gga	getGNSSAttitude									
		none								
		MovingBase								

RxControl: Navigation > Positioning Mode > GNSS Attitude

Use this command to define/inquire the way GNSS-based attitude is computed.

The attitude of a vehicle (more precisely the heading and pitch angles) can be determined from the orientation of the baseline between two antennas attached to the vehicle. See also the **setAntennaLocation** command.

The *Source* argument specifies how to compute the GNSS-based attitude:

Source	Description
none	GNSS attitude computation is disabled.
MovingBase	Attitude is computed from the baseline between antennas connected to two receivers configured in moving-base RTK operation (moving-base attitude).

Example

```
COM1> sga, MovingBase <CR>
$R: sga, MovingBase
    GNSSAttitude, MovingBase, Fixed
COM1>
```

3.2.8 Datum Definition

sgd ggd	setGeodeticDatum getGeodeticDatum	TargetDatum								
		WGS84 ETRS89 NAD83 NAD83_PA NAD83_MA GDA94 GDA2020 Default User1 User2								

[RxControl: Navigation > Receiver Operation > Position > Datum](#)

Use this command to define the datum to which you want the coordinates to refer.

TargetDatum	Description
WGS84	Equivalent to <code>Default</code>
ETRS89	European ETRS89 (ETRF2000 realization)
NAD83	NAD83(2011), North American Datum (2011)
NAD83_PA	NAD83(PA11), North American Datum, Pacific plate (2011)
NAD83_MA	NAD83(MA11), North American Datum, Marianas plate (2011)
GDA94	GDA94(2010), Geocentric Datum of Australia (2010)
GDA2020	GDA2020, Geocentric Datum of Australia 2020
Default	Default datum, which depends on the positioning mode as explained below except when a built-in local coordinate operation is manually selected with the setLocalCoordOperation command. In that case, the datum is set accordingly to the selected coordinate operation.
User1	First user-defined datum. The corresponding transformation parameters must be specified by the setUserDatum and setUserDatumVel commands, while the corresponding ellipsoid must be defined by the setUserEllipsoid command.
User2	Second user-defined datum

By default (argument *TargetDatum* set to `Default`), the datum depends on the positioning mode. For standalone and SBAS positioning, the coordinates refer to a global datum: WGS84 or ITRF (recent realisations of WGS84 and ITRF are closely aligned and the receiver considers them equivalent). When using DGNSS or RTK corrections from a regional DGNSS/RTK provider, the coordinates usually refer to a regional datum (e.g. ETRS89 in Europe or NAD83 in North America).

With this command, the user can select the datum the coordinates should refer to. In case you are using corrections from a regional DGNSS/RTK provider, the datum to be specified here must be the datum used by your correction provider.

When a non-default datum is selected, the receiver transforms all the WGS84/ITRF coordinates to the specified datum. Positions obtained using local or regional DGNSS/RTK corrections are not transformed, as it is assumed that the selected datum is the one used by the DGNSS/RTK provider.

In the current firmware version, the `WGS84` value for the *TargetDatum* argument has no effect, but it is kept for backwards compatibility reasons. Setting *TargetDatum* to `WGS84` is equivalent to setting it to `Default`.

Example

```
COM1> sgd, ETRS89 <CR>
$R: sgd, ETRS89
    GeodeticDatum, ETRS89
COM1>
```

sud gud	setUserDatum getUserDatum	Datum Datum	T_x	T_y	T_z	R_x	R_y	R_z	D	
		+ User1	-2000000.00	-2000000.00	-2000000.00	-100.0000	-100.0000	-100.0000	-100.000000	...
		+ User2	... 0.00	... 0.00	... 0.00	... 0.0000	... 0.0000	... 0.0000	... 0.000000	...
		all	... 2000000.00 mm	... 2000000.00 mm	... 2000000.00 mm	... 100.0000 mas	... 100.0000 mas	... 100.0000 mas	... 100.000000 ppb	

[RxControl: Navigation > Receiver Operation > Position > Datum](#)

Use these commands to define datum transformation parameters from the global WGS84/ITRF datum to the user datum identified by the first argument.

The receiver applies the linearized form of the Helmert similarity transformation. The coordinates in WGS84/ITRF are transformed to the user datum using the following formula:

$$\begin{pmatrix} X \\ Y \\ Z \end{pmatrix}_{User} = \begin{pmatrix} T_x \\ T_y \\ T_z \end{pmatrix} + \begin{pmatrix} D+1 & -R_z & R_y \\ R_z & D+1 & -R_x \\ -R_y & R_x & D+1 \end{pmatrix} \cdot \begin{pmatrix} X \\ Y \\ Z \end{pmatrix}_{WGS84/ITRF}$$

where T_x , T_y and T_z are the three translation components, R_x , R_y and R_z are the rotation angles and D is the scale factor. Note that the rotation angles are expressed in radians in the above formula, but they must be provided in milliarcsecond (1 mas = $2\pi/360/3600000$ radians) in the arguments of the command. The sign convention corresponds to that of the IERS Conventions (2010), Technical Note No. 36.

The time derivative of the transformation parameters can be specified with the command **setUserDatumVel**.

For the receiver to apply the transformation parameters, the corresponding user datum must be selected in the **setGeodeticDatum** command.

Example

```
COM1> sud, User1, 52.1, 49.3, -58.5, 0.891, 5.390, -8.712,
      1.34<CR>
$R: sud, User1, 52.1, 49.3, -58.5, 0.891, 5.390, -8.712, 1.34
      UserDatum, User1, 52.10, 49.30, -58.50, 0.8910, 5.3900, -8.7120,
      1.34000
COM1>
```

sudv gudv	setUserDatumVel getUserDatumVel	Datum Datum	TxVel	TyVel	TzVel	RxVel	RyVel	RzVel	DVel	RefYear
		+ User1 + User2 all	-2000.00 ... 0.00 ... 2000.00 mm/yr	-2000.00 ... 0.00 ... 20000.00 mm/yr	-2000.00 ... 0.00 ... 2000.00 mm/yr	-10.0000 ... 0.0000 ... 10.0000 mas/yr	-10.0000 ... 0.0000 ... 10.0000 mas/yr	-10.0000 ... 0.0000 ... 10.0000 mas/yr	-1.00000 ... 0.00000 ... 1.00000 ppb/yr	1900.00 ... 2000.00 ... 2100.00 yr

[RxControl: Navigation > Receiver Operation > Position > Datum](#)

Use these commands to define the time derivative of the seven datum transformation parameters defined with the **setUserDatum** command.

For instance, *TxVel* is the yearly change of the X-translation component. At the epoch specified with *RefYear* (in decimal years), the X-translation component is *Tx* as defined in **setUserDatum**. One year later, the X-translation component is $Tx + TxVel$, etc.

Refer to the **setUserDatum** command for a description of the datum transformation formula implemented in the receiver.

Example

```
COM1> sudv, User1, 0.1, 0.1, -1.8, 0.081, 0.49, -0.792, 0.08,
      2000<CR>
$R: sudv, User1, 0.1, 0.1, -1.8, 0.081, 0.49, -0.792, 0.08, 2000
      UserDatumVel, User1, 0.10, 0.10, -1.80, 0.0810, 0.4900, -0.7920,
      0.08000, 2000.00
COM1>
```

sue gue	setUserEllipsoid getUserEllipsoid	Datum Datum	A	Invf						
		+ User1	6300000.000	290.000000000						
		+ User2	... 6378137.000	... 298.257223563						
		all	... 6400000.000 m	... 305.000000000						

RxControl: Navigation > Receiver Operation > Position > Datum

Use these commands to define the ellipsoid associated with the `User1` or `User2` datum.

a is the reference ellipsoid semi-major axis and $Invf$ is the inverse of the flattening.

See also the `setGeodeticDatum` and the `setUserDatum` commands.

Example

```
COM1> sue, User1, 6378388, 297 <CR>
$R: sue, User1, 6378388, 297
      UserEllipsoid, User1, 6378388.000, 297.000000000
COM1>
```

3.2.9 Transformation to Local Coordinates

smth	setENHTransfoHorizontal	TransfoID	DeltaE	DeltaN	E0	N0	AlphaEE	AlphaEN	AlphaNE	AlphaNN
gmth	getENHTransfoHorizontal	TransfoID								
		+ lt1	-250.0000	-250.0000	-8000000.0000	-8000000.0000	-1000.0000	-1000.0000	-1000.0000	-1000.0000
		all	... 0.0000	... 0.0000	... 0.0000	... 0.0000	... 0.0000	... 0.0000	... 0.0000	... 0.0000
			... 250.0000 m	... 250.0000 m	... 8000000.0000	... 8000000.0000	... 1000.0000	... 1000.0000	... 1000.0000	... 1000.0000
					m	m	ppm	ppm	ppm	ppm

[RxControl: Navigation > Receiver Operation > Position > Local Transformations](#)

This command defines how to adjust the easting and northing coordinates if a plane grid coordinate adjustment is enabled with the *ENHTransfo* argument of the **setLocalCoordOperation** command.

If enabled, the receiver applies the following transformation as last step in the computation of the easting and northing, prior to outputting them in the *PosProjected* SBF block:

$$\begin{pmatrix} E_T \\ N_T \end{pmatrix} = \begin{pmatrix} E_S \\ N_S \end{pmatrix} + \begin{pmatrix} \delta E \\ \delta N \end{pmatrix} + \begin{pmatrix} \alpha_{EE} & \alpha_{EN} \\ \alpha_{NE} & \alpha_{NN} \end{pmatrix} \cdot \begin{pmatrix} E_S - E_0 \\ N_S - N_0 \end{pmatrix}$$

where E_S and N_S are the easting and northing prior to the transformation, and the other parameters are the arguments of this command. Note that the *alpha* arguments are expressed in ppm.

Example

```
COM1> smth, lt1, 10.904, 10.904, 156.341, 1.3, 1.34, 1.34, 1.34,
      1.34<CR>
$R: smth, lt1, 10.904, 10.904, 156.341, 1.3, 1.34, 1.34, 1.34, 1.34
      ENHTransfoHorizontal, lt1, 10.9040, 10.9040, 156.3410, 1.3000,
      1.3400, 1.3400, 1.3400, 1.3400
COM1>
```

smtv	setENHTransfoVertical	TransfoID	DeltaH	E0	N0	AlphaHE	AlphaHN			
gmtv	getENHTransfoVertical	TransfoID								
		+ lt1	-250.0000	-8000000.0000	-8000000.0000	-1000.0000	-1000.0000			
		all	... 0.0000	... 0.0000	... 0.0000	... 0.0000	... 0.0000			
			... 250.0000 m	... 8000000.0000	... 8000000.0000	... 1000.0000	... 1000.0000			
				m	m	ppm	ppm			

[RxControl: Navigation > Receiver Operation > Position > Local Transformations](#)

This command defines how to adjust the height coordinate if a plane grid coordinate adjustment is enabled with the *ENHTransfo* argument of the **setLocalCoordOperation** command.

If enabled, the receiver applies the following transformation as last step in the computation of the height, prior to outputting it in the `Alt` field of the `PosProjected` SBF block:

$$H_T = H_S + \delta H + \alpha_{HE}(E_S - E_0) + \alpha_{HN}(N_S - N_0)$$

where E_S , N_S and H_S are the easting, northing and height before transformation, in meters, and the other parameters are the arguments of this command. Note that the *alphaHE* and *alphaHN* arguments are expressed in ppm.

Example

```
COM1> smtv, lt1, 10.904, 156.341, 1.3, 1.34, 1.34<CR>
$R: smtv, lt1, 10.904, 156.341, 1.3, 1.34, 1.34
    ENHTransfoVertical, lt1, 10.9040, 156.3410, 1.3000, 1.3400,
    1.3400
COM1>
```

slco	setLocalCoordOperation	OpName (100)	ENHTransfo							
glco	getLocalCoordOperation									
		NETWORK	none lt1							

[RxControl: Navigation > Receiver Operation > Position > Local Transformations](#)

Use this command to define the set of operations needed to obtain coordinates in a local coordinate reference system (CRS). The coordinates in the local CRS can be geodetic coordinates (latitude, longitude and local height) reported in the `PosLocal` SBF block, and/or plane grid coordinates (easting, northing) reported in the `PosProjected` SBF block.

The list of possible operations, i.e. the list of valid values for the `OpName` argument, is returned by the `lstLocalCoordOperations` command. The list contains at least two entries: `NONE`, which disables the local operations, and `NETWORK`, which instructs the receiver to use the operation set provided by the DGPS/RTK service provider. In addition, a number of built-in operations are also available. The `NETWORK` operation is the default.

If the `OpName` argument does not match any entry in the list returned by `lstLocalCoordOperations`, `NONE` is assumed.

When selecting the `NETWORK` mode, it is recommended to specify the regional datum in which the network operates, using the `setGeodeticDatum` command. This allows the receiver to continue to output local coordinates during RTK/DGPS outages without datum shift issues. This is not needed when selecting one of the built-in operations.

In some cases, a final adjustment is still needed to obtain accurate plane grid coordinates. The `ENHTransfo` argument can be used for that purpose. It selects a local transformation to be applied as final step in the computation of the easting, northing and local height. The corresponding transformation parameters must be set with the `setENHTransfoHorizontal` and `setENHTransfoVertical` commands. By default, this final adjustment is disabled.

Example

```
COM1> slco, NONE, lt1<CR>
$R: slco, NONE, lt1
    LocalCoordOperation, NONE, lt1
COM1>
```

llc	IstLocalCoordOperations	Operation								
		Overview								

Use this command with the argument *Operation* set to *Overview* to get a list of all built-in local coordinate operations. See also the **setLocalCoordOperation** command.

Example

```
COM1> llc, Overview <CR>
$R; llc, Overview
... Here comes the list of known coordinate operations ...
COM1>
```

3.2.10 Timing and Time Management

scst	setClockSyncThreshold	Threshold								
gcst	getClockSyncThreshold									
		ClockSteering								
		<u>usec500</u>								
		msec1								
		msec2								
		msec3								
		msec4								
		msec5								

[RxControl: Navigation > Receiver Operation > Timing](#)

Use these commands to define/inquire the maximum allowed offset between the receiver internal clock and the system time defined by the **setTimingSystem** command.

If the argument `ClockSteering` is selected, the receiver internal clock is continuously steered to the system time to within a couple of nanoseconds. Clock steering accuracy is dependent on the satellite visibility, and it is recommended to only enable it under open-sky conditions.

If any other argument is selected, the internal clock is left free running. Synchronization with the system time is done through regular millisecond clock jumps. More specifically, when the receiver detects that the time offset is larger than *Threshold*, it initiates a clock jump of an integer number of milliseconds to re-synchronise its internal clock with the system time. These clock jumps have no influence on the generation of the xPPS pulses: the xPPS pulses are always maintained within a few nanoseconds from the requested time, regardless of the value of the *Threshold* argument.

Refer to section 2.3 for a more detailed description of the time keeping in your receiver.

Example

```
COM1> scst, msec1<CR>
$R: scst, msec1
    ClockSyncThreshold, msec1
COM1>
```

sep gep	setEventParameters getEventParameters	Event Event	Polarity	Delay						
		+ EventA + EventB all	Low2High High2Low	-500.000000 ... 0.000000 ... 500.000000 ms						

[RxControl: Navigation > Receiver Operation > Timing](#)

Use these commands to define/inquire the polarity of the electrical transition on which the receiver will react on its `Event` input(s). The polarity of each event pin can be set individually or simultaneously by using the value `all` for the `Event` argument.

The command also allows defining a time delay for each event. This can be handy when the electrical transition at the event pin is not synchronous with the actual event that needs to be timed. For example, if the electrical transition occurs 100 milliseconds prior to the actual event of interest, the `Delay` argument must be set to 100. `Delay` is positive when the event of interest occurs after the electrical transition, and negative otherwise.

The event time (corrected by the specified delay) is available in the `ExtEvent` SBF block. The position at that time is available in the `ExtEventPVTCartesian` and `ExtEventPVTGeodetic` SBF blocks and the attitude angles in the `ExtEventAttEuler` SBF block. Beware that, when using large `Delay` values in high-dynamics conditions, the position accuracy may degrade.

Note that, when an event pin is configured in `TimeSync` mode with the `setTimeSyncSource` command, the functionality of the pin changes: the `Delay` argument has no effect, and no SBF blocks are generated upon electrical transitions. See the `setTimeSyncSource` command for details.

Example

```
COM1> sep, EventA, High2Low, 10<CR>
$R: sep, EventA, High2Low, 10
    EventParameters, EventA, High2Low, 10.000000
COM1>
```

sntp gntp	setNTPServer getNTPServer	Enable								
		off on								

RxControl: Navigation > Receiver Operation > Timing

Use this command to enable or disable the built-in NTP (Network Time Protocol) server.

When enabled, the NTP server accepts UDP timestamp requests on port number 123.

Example

```
COM1> sntp, on<CR>
$R: sntp, on
      NTPServer, on
COM1>
```

spps gpps	setPPSPParameters getPPSPParameters	Interval	Polarity	Delay	TimeScale	MaxSyncAge	PulseWidth			
		off msec10 msec20 msec50 msec100 msec200 msec250 msec500 sec1 sec2 sec5 sec10	Low2High High2Low	-1000000.00 ... 0.00 ... 1000000.00 ns	TimeSys UTC RxClock GLONASS	0 ... 60 ... 3600 s	0.001 ... 5.000 ... 1000.000 ms			

[RxControl: Navigation > Receiver Operation > Timing](#)

Use these commands to define/inquire the parameters of the x-pulse-per-second (xPPS) output. Refer to section 1.18 for additional information on the xPPS functionality.

The *Interval* argument specifies the time interval between the pulses. A special value "off" is defined to disable the xPPS signal.

The *Polarity* argument defines the polarity of the xPPS signal.

The *Delay* argument can be used to compensate for the overall signal delays in the system (including antenna, antenna cable and xPPS cable). Setting *Delay* to a higher value causes the xPPS pulse to be generated earlier. For example, if the antenna cable is replaced by a longer one, the overall signal delay could be increased by, say, 20 ns. If *Delay* is left unchanged, the xPPS pulse will come 20 ns too late. To re-synchronize the xPPS pulse, *Delay* has to be increased by 20 ns.

By default, the xPPS pulses are aligned with the satellite time system (*TimeSys*) that is defined by the **setTimingSystem** command. Using the *TimeScale* argument, it is also possible to align the xPPS pulse with the local receiver time (*RxClock*), with GLONASS time or with UTC.

When *TimeScale* is set to anything else than *RxClock*, the accuracy of the position of the xPPS pulse depends on the age of the last PVT computation. During PVT outages (due for instance to signal blockage), the xPPS position is extrapolated on the basis of the last available PVT information, and may start to drift. To avoid large biases, the receiver stops outputting the xPPS pulse when the last PVT is older than the age specified in the *MaxSyncAge* argument. If *MaxSyncAge* is set to 0, or if *TimeScale* is set to *RxClock*, this timeout is disabled.

The *PulseWidth* argument sets the duration of the PPS pulse. The maximum duration of the pulse equals the PPS interval minus 100 microseconds, even if the requested *PulseWidth* is longer than that.

Example

```
COM1> spps, sec1, High2Low, 23.40, TimeSys, 60, 0.1<CR>
$R: spps, sec1, High2Low, 23.40, TimeSys, 60, 0.1
  PPSPParameters, sec1, High2Low, 23.40, TimeSys, 60, 0.100
COM1>
```

stss	setTimeSyncSource	Source								
gtss	getTimeSyncSource									
		none EventA EventB								

[RxControl: Navigation > Receiver Operation > Timing](#)

Use this command to set which event input pin to be used as TimeSync input.

When an event pin is configured as TimeSync input, the receiver will synchronize its internal time base to the electrical transitions on that pin. Instead of reporting the time of electrical transitions on the event pin in the `ExtEvent` SBF block, the receiver will synchronize itself to the transitions.

The transition polarity (rising or falling edge) is set with the **setEventParameters** command.

A typical use case of the TimeSync input is in conjunction with the REF IN input: the receiver is fed with a 10 MHz frequency reference on its REF IN input, and to a one-per-second time pulse on its TimeSync input. The 10 MHz frequency and the one-per-second time pulse originate from the same clock.

Example

```
COM1> stss, EventB<CR>
$R: stss, EventB
      TimeSyncSource, EventB
COM1>
```

sts	setTimingSystem	<i>System</i>								
gts	getTimingSystem									
		GST GPS BeiDou								

[RxControl: Navigation > Receiver Operation > Timing](#)

Use these commands to define/inquire the reference time system for the computation of the receiver clock bias.

As part of the PVT computation, the receiver determines the offset between its own time (receiver time) and the time of the GNSS system specified with the *System* argument (GST stands for Galileo System Time). This offset is reported in the `RxClkBias` field of the `PVTCartesian` and `PVTGeodetic` SBF blocks.

 Note that at least one satellite of the selected system must be visible and tracked by the receiver. Otherwise no PVT will be computed.

This command also defines the position of the PPSout pulses if the PPSout time scale is set to `TimeSys` with the **setPPSPParameters** command.

Example

```
COM1> sts, GPS<CR>
$R: sts, GPS
    TimingSystem, GPS
COM1>
```

3.2.11 Station Settings

smp	setMarkerParameters	MarkerName (60)	MarkerNumber (2)	MarkerType (20)	StationCode (10)	MonumentIdx	ReceiverIdx	CountryCode (3)		
gmp	getMarkerParameters									
		SEPT	Unknown	Unknown		0...9	0...9			

[RxControl: Navigation > Receiver Setup > Station Settings](#)

Use these commands to define/inquire the marker and station parameters.

The set of allowed characters for the *MarkerName* argument and for the *StationCode* argument is limited to:

`_0123456789ABCDEFGHIJKLMNPOQRSTUVWXYZabcdefghijklmnopqrstuvwxyz`

The *StationCode* argument is the site code associated to the station (typically four characters). *MonumentIdx* can be used to identify the monument when there are multiple monuments at the same station. *ReceiverIdx* can be used to identify the receiver when there are multiple receivers at the same monument. A three-letter ISO country code can be specified with the *CountryCode* argument.

If internal logging is enabled in one of the IGS file naming modes, the file name depends on the settings of the **setMarkerParameters** command. Refer to the description of the logging commands (**setFileNaming**, **setRINEXLogging**) for details.

The parameters set by this command are copied into the `ReceiverSetup` SBF block, which defines the file name and the header contents when converting SBF files into RINEX with the `sbf2rin` program.

Example

```
COM1> smp, Test, 356, GEODETIC, TST1, 0, 0, BEL<CR>
$R: smp, Test, 356, GEODETIC, TST1, 0, 0, BEL
    MarkerParameters, Test, 356, GEODETIC, TST1, 0, 0, BEL
COM1>
```

soc	setObserverComment	<i>Comment (120)</i>								
goc	getObserverComment									
		<u>Unknown</u>								

[RxControl: Navigation > Receiver Setup > Station Settings](#)

Use these commands to define/inquire the content of the `Comment` SBF block.

Examples

```
COM1> soc, "Data taken with choke ring antenna"<CR>
$R: soc, "Data taken with choke ring antenna"
  ObserverComment, "Data taken with choke ring antenna"
COM1>
```

```
COM1> goc <CR>
$R: goc
  ObserverComment, "Data taken with choke ring antenna"
COM1>
```

sop	setObserverParameters	<i>Observer (20)</i>	<i>Agency (40)</i>							
gop	getObserverParameters									
		<u>Unknown</u>	<u>Unknown</u>							

[RxControl: Navigation > Receiver Setup > Station Settings](#)

Use these commands to define/inquire the observer name or ID, and his/her agency. These parameters are copied in the `ReceiverSetup` SBF block and in the header of RINEX observation files.

The length of the arguments complies with the RINEX format definition.

Examples

```
COM1> sop, TestObserver, TestAgency <CR>
$R: sop, TestObserver, TestAgency
  ObserverParameters, "TestObserver", "TestAgency"
COM1>
```

```
COM1> gop <CR>
$R: gop
  ObserverParameters, "TestObserver", "TestAgency"
COM1>
```

3.2.12 General Input/Output

scia	setCheckInternetAvailability	<i>Mode</i>								
gcia	getCheckInternetAvailability									
		off								
		on								

RxControl: Communication > Network Settings > General

This command enables or disables the continuous checking of Internet access. When active, the check is done every 1 minute. Therefore, it may take up to 1 minute for changes in Internet availability to be reported.

Example

```
COM1> scia, on <CR>
$R: scia, on
    CheckInternetAvailability, on
COM1>
```

scs gcs	setCOMSettings getCOMSettings	Cd Cd	Rate	DataBits	Parity	StopBits	FlowControl			
		+ COM1	baud1200	<u>bits8</u>	No	<u>bit1</u>	<u>none</u>			
		+ COM2	baud2400				RTS CTS			
		+ COM3	baud4800							
		+ COM4	baud9600							
		all	baud19200							
			baud38400							
			baud57600							
			<u>baud115200</u>							
			baud230400							
			baud460800							
			baud500000							
			baud576000							
			baud921600							
			baud1000000							
			baud1152000							
			baud1500000							
			baud2000000							
			baud2500000							
			baud3000000							
			baud3500000							
			baud4000000							

RxControl: Communication > COM Port Settings

Use these commands to define/inquire the communication settings of the receiver's COM ports. By default, all COM ports are set to a baud rate of 115200 baud, using 8 data-bits, no parity, 1 stop-bit and no flow control.

Depending on your receiver hardware, it may be that not all COM ports support flow control. Please refer to the receiver Hardware Manual or User Manual to check which COM ports are equipped with the RTS/CTS lines.

When modifying the settings of the current connection, make sure to also modify the settings of your terminal emulation program accordingly.

Example

```
COM1> scs, COM1, baud19200, bits8, No, bit1, RTS|CTS<CR>
$R: scs, COM1, baud19200, bits8, No, bit1, RTS|CTS
    COMSettings, COM1, baud19200, bits8, No, bit1, RTS|CTS
COM1>
```

scda	setCrossDomainWebAccess	<i>Mode</i>								
gcda	getCrossDomainWebAccess									
		off								
		on								

[RxControl: Communication > Network Settings > General](#)

This command enables or disables true open access across domain boundaries according to the CORS specification (Cross-Origin Resource Sharing).

Setting the *Mode* argument to `on` enables the cross-domain access to the receiver web server, and as such it allows external client applications (e.g. your own web application) to access receiver data via HTTP requests. Please contact Septentrio support for additional information on the receiver's JavaScript libraries.

Example

```
COM1> scda, on <CR>
$R: scda, on
    CrossDomainWebAccess, on
COM1>
```

sdcm	setDaisyChainMode	DC	Mode							
gdc	getDaisyChainMode	DC								
		+ DC1	Raw							
		+ DC2	ASCII							
		all								

RxControl: Communication > Input/Output Selection

Use this command to define how data is transferred in a daisy chain configured with the **setDataInOut** command.

By default (*Mode* is `Raw`), incoming bytes are transferred in small chunks from the input to the output connector.

In some cases, it is preferred to transmit complete ASCII strings at once. This can be done by configuring the daisy chain in ASCII mode. A string is considered complete when a carriage-return and/or a line-feed character is received.

Example

```
COM1> sdcm, DC1, ASCII<CR>
$R: sdcm, DC1, ASCII
  DaisyChainMode, DC1, ASCII
COM1>
```

sdio gdio	setDataInOut getDataInOut	Cd Cd	Input	Output	Show					
		+ DSK1	none	none	(off)					
		+ COM1	CMD	+ RTCMv2	(on)					
		+ COM2	RTCMv2	+ RTCMv3	(waiting)					
		+ COM3	RTCMv3	+ CMRv2						
		+ COM4	CMRv2	+ <u>SBE</u>						
		+ USB1	DC1	+ <u>NMEA</u>						
		+ USB2	DC2	+ ASCIIIDisplay						
		+ IP10 ... IP17	ASCIIN	+ DC1						
		+ NTR1	SPARTN	+ DC2						
		+ NTR2	auto	+ Encapsulate						
		+ NTR3		+ LBandBeam1						
		+ NTR4		+ LBandBeam2						
		+ IPS1								
		+ IPS2								
		+ IPS3								
		+ IPS4								
		+ IPS5								
		+ IPR1								
		+ IPR2								
		+ IPR3								
		+ IPR4								
		+ IPR5								
		all								

RxControl: Communication > Input/Output Selection

Use these commands to define/inquire the type of data that the receiver should accept/send on a given connection descriptor (*Cd* - see 1.1.5).

The *Input* argument is used to tell the receiver how to interpret incoming bytes on the connection *Cd*. If a connection is to be used for receiving user commands or differential corrections in RTCM or CMR format, it is recommended to leave it in the default `auto` input mode. In this mode, the receiver automatically detects the input format.

It is also possible to set the input format explicitly. `CMD` means that the connection is to be used for user command input exclusively. `RTCMv2`, `RTCMv3` and `CMRv2` can be used to manually select the differential correction format, overriding the auto detection. `ASCIIN` is used for connections receiving free-formatted ASCII messages, e.g. from an external meteo sensor.

In `auto` mode, the receiver automatically detects the `CMD`, `RTCMv2`, `RTCMv3`, or `CMRv2` formats. The other input formats must be specified explicitly.

A connection that is not configured in `CMD` mode or `auto` mode will be blocked for user commands. There are two ways to re-enable the command input on a blocked connection. The first way is to reconfigure the connection by entering the command `setDataInOut` from another connection. The second way is to send the "escape sequence" consisting of a succession of ten "S" characters to the blocked connection within a time interval shorter than 5 seconds.

A connection that is configured in `auto` mode will initially accept user commands and differential corrections. However, as soon as differential corrections have been detected, the connection is blocked for user commands until the escape sequence is received.

The *Output* argument is used to select the types of data allowed as output. The receiver supports outputting different data types on the same connection. The `ASCIIIDisplay` is a textual report of the tracking and PVT status at a fixed rate of 1Hz. It can be used

to get a quick overview of the receiver operation. The `LBandBeami` option is to output the stream of bytes decoded from an L-Band beam (not available for some proprietary streams). The `Encapsulate` option has the effect of encapsulating all non-SBF output into the `EncapsulatedOutput` SBF block. For instance, setting the `Output` argument to `NMEA+Encapsulate` instructs the receiver to encapsulate all NMEA messages into the `EncapsulatedOutput` SBF block.

`DC1` and `DC2` represent two internal pipes that can be used to create a daisy-chain. Set the `Input` argument to `DCi` to connect the input of pipe *i* to the specified connection. Set the `Output` argument to `DCi` to connect the output of pipe *i* to the specified connection. The daisy-chain can operate in binary or ASCII mode, as configured with the `setDaisyChainMode` command.

After the `Cd`, `Input` and `Output` arguments, an extra read-only `Show` argument will be returned in the command reply. This last argument can take the value `on`, `off` or `waiting`, depending on whether the connection descriptor is open, close, or waiting for a connection.

The `Input` argument is ignored for output-only connections, and the `Output` argument is ignored for input-only connections. See section 1.1.5 for details.

Note that not all input connections can accept user commands, check section 1.1.5 for details.

Examples

```
COM1> sdio, COM1, CMD <CR>
$R: sdio, COM1, CMD
  DataInOut, COM1, CMD, SBF, (on)
COM1>
```

On receivers that have three COM ports, to set up a two-way daisy-chain between `COM2` and `COM3`, i.e. to have all incoming bytes from `COM2` redirected to `COM3` and all incoming bytes from `COM3` redirected to `COM2`, enter the following commands from a connection different than `COM2` and `COM3`:

```
COM1> sdio, COM2, DC1, DC2 <CR>
$R: sdio, COM2, DC1, DC2
  DataInOut, COM2, DC1, DC2, (on)
COM1> sdio, COM3, DC2, DC1 <CR>
$R: sdio, COM3, DC2, DC1
  DataInOut, COM3, DC2, DC1, (on)
COM1>
```

sdds gdds	setDynamicDNS getDynamicDNS	Provider	UserName (40)	Password (40)	Hostname (40)	Bind				
		off dyndns.org no-ip.com				auto Ethernet				

[RxControl: Communication > Network Settings > DynDNS](#)

This command configures the built-in dynamic DNS client (DynDNS or DDNS).

Before using DynDNS, you will need to create an account and define a hostname for your receiver at one of the supported DynDNS providers. The list of supported providers is shown below.

Provider	Description
off	DynDNS disabled
dyndns.org	dyndns.org
no-ip.com	no-ip.com

The *Provider* argument specifies your DynDNS provider, the *UserName* and *Password* arguments specify the account credentials at this provider, and the *Hostname* is the full hostname associated to your receiver. Setting the *Provider* to `off` disabled the DynDNS functionality.

On receivers with multiple active network interfaces, the receiver registers the public IP address of the interface with the highest priority (Ethernet first, then WiFi), unless a specific interface is forced with the *Bind* argument.

The receiver checks every 2 minutes if the public IP address has changed, and updates the DynDNS server if needed. In addition a forced DynDNS server update is performed every 30 days. This is done to prevent the expiration of a DynDNS entry.

The DynDNS settings configured by this command are applied immediately and are kept upon a power cycle and even after a reset to factory default (see command **exeResetReceiver**).

Note that this command is not shown in the output of the **lstConfigFile** command.

Example

```
COM1> sdds, dyndns.org, Bart, MyPwd, rx1.dyndns-free.com, auto<CR>
$R: sdds, dyndns.org, Bart, MyPwd, rx1.dyndns-free.com, auto
    DynamicDNS, dyndns.org, Bart, MyPwd, rx1.dyndns-free.com, auto
COM1>
```

eecm gecm	exeEchoMessage getEchoMessage	Cd	Message (242)	EndOfLine					
		DSK1 COM1 COM2 COM3 COM4 USB1 USB2 IP10 ... IP17 IPS1 IPS2 IPS3 IPS4 IPS5 IPR1 IPR2 IPR3 IPR4 IPR5 DC1 DC2	A:Unknown	none + CR + LF all					

[RxControl: Communication > Output Settings > Echo Message](#)

Use this command to send a message to one of the connections of the receiver.

The *Message* argument defines the message that should be sent on the *Cd* port. If the given message starts with "A:", the remainder of the message is considered an ASCII string that will be forwarded without changes to the requested connection. If the given message starts with "H:", the remainder of the message is considered a hexadecimal representation of a succession of bytes to be sent to the requested connection. In this case, the string should be a succession of 2-character hexadecimal values separated by a single whitespace.

Make sure to enclose the string between double quotes if it contains whitespaces. The maximum length of the *Message* argument (including the A: or H: prefix) is 242 characters.

The *EndOfLine* argument defines which end-of-line character should be sent after the message. That argument is ignored when the *Message* argument starts with H:.

To send a message at a regular interval instead of once, use the command **setPeriodicEcho**.

When the *Cd* argument is DC1 or DC2, the message is injected into one of the internal daisy-chain pipes. See the **setDataInOut** command for details.

Examples

To send the string "Hello world!" to COM2, use:

```
COM1> eecm, COM2, "A:Hello world!", none <CR>
$R: eecm, COM2, "A:Hello world!", none
EchoMessage, COM2, "A:Hello world!", none
COM1>
```

To send the same string, the following command can also be used:

```
COM1> eecm, COM2, "H:48 65 6C 6C 6F 20 77 6F 72 6C 64 21", none
<CR>
```

```
$R: eecm, COM2, "H:48 65 6C 6C 6F 20 77 6F 72 6C 64 21", none  
    EchoMessage, COM2, "H:48 65 6C 6C 6F 20 77 6F 72 6C 64 21", none  
COM1>
```

shs	setHttpsSettings	<i>Protocol</i>								
ghs	getHttpsSettings									
		+ HTTP + HTTPS all								

RxControl: Communication > Network Settings > Security

This command can be used to enable or disable http and/or https access to the receiver. By default, both http and https are enabled.

Secure http access requires the user to provide a certificate to the receiver. This is done by navigating to the "Communication > Web Server/TLS" page of the web interface, and uploading a `.pem` file containing the certificate. By default, if no user-provided certificate is available, the receiver will use a self-signed certificate instead. The user-provided certificate can be erased with **exeResetReceiver, hard, HTTPSCertificate** command, reverting to the self-signed certificate.

Note that the https certificate is also applicable to the built-in NTRIP caster in TLS mode. See also the **setNtripCasterSettings** command.

Example

```
COM1> shs, HTTP<CR>
$R: shs, HTTP
    httpsSettings, HTTP
COM1>
```

sipf gipf	setIPFiltering getIPFiltering	Mode	AddrList (200)							
		off on								

RxControl: Communication > Network Settings > Security

Use this command to configure the IP filtering functionality. When IP filtering is enabled, only the specified IP addresses are allowed to connect to the receiver.

By default, IP filtering is off (the *Mode* argument is `off`) and the receiver accepts connections from any IP address.

When enabling IP filtering (*Mode* set to `on`), the *AddrList* argument must contain a whitespace-separated list of IP addresses (IPv4) allowed to connect to the receiver. Only IP addresses are allowed here, not hostnames. To enable a whole range of IP addresses, a netmask can also be specified using the so-called "slash notation", where the IP address is followed by a forward slash (/) and the subnet mask number from 0 to 32.

After entering the command, existing IP connections are kept active, but any new connection from a non-allowed IP address will be rejected.

Example

```
COM1> sipf, on, 192.168.0.7 192.168.2.0/24<CR>
$R: sipf, on, 192.168.0.7 192.168.2.0/24
    IPFiltering, on, 192.168.0.7 192.168.2.0/24
COM1>
```

sipp	setIPPortSettings	Command	FTPControl						
gipp	getIPPortSettings								
		1 ... 28784 ... 65535	1 ... 21 ... 65535						

[RxControl: Communication > Network Settings > General](#)

Use these commands to define/inquire the port numbers where the receiver listens for incoming TCP/IP connections.

The *Command* argument defines the port where the receiver listens for user commands.

The *FTPControl* argument defines the FTP control port number.

The IP port numbers configured by this command keep their value upon a power cycle and even after a reset to factory default (see command **exeResetReceiver**).

Note that this command is not shown in the output of the **lstConfigFile** command.



When selecting a port number, make sure to avoid conflicts with other services (for example select a different port than in the **setIPServerSettings** and the **setIPReceiveSettings** commands).

Example

```
COM1> sipp, 12345, 21<CR>
$R: sipp, 12345, 21
    IPPortSettings, 12345, 21
COM1>
```

sirs	setIPReceiveSettings	Cd	Port	Mode	TCPAddress (40)					
girs	getIPReceiveSettings	Cd								
		+ IPR1 + IPR2 + IPR3 + IPR4 + IPR5 all	0...65535	TCP2Way UDP	0.0.0.0					

[RxControl: Communication > Network Settings > General](#)

This command configures the "IP receive" ports (IPR).

When *Mode* is set to `TCP2Way`, the receiver connects to the specified port of a server of which the IP address or hostname is provided in the *TCPAddress* argument. It then receives all data sent by this server on that port. The `TCP2Way` connection is bidirectional, and it is possible to send data to the server or to process commands from the server.

When *Mode* is set to `UDP`, the receiver listens for incoming UDP messages on its port identified by the *Port* argument. In `UDP` mode, the *TCPAddress* argument is ignored. Note that, contrary to the TCP connection, the UDP connection is unidirectional.

If *Port* is set to 0, the corresponding IPR connection is disabled.

This command is the counterpart of the `setIPServerSettings` command. `setIPServerSettings` configures the sender side of the communication, while `setIPReceiveSettings` configures the receiver side.



When selecting a port number, make sure to avoid conflicts with other services (for example select a different port than in the `setIPPortSettings` command).

Example

```
COM1> sirs, IPR1, 28785, TCP2Way, 192.168.10.5<CR>
$R: sirs, IPR1, 28785, TCP2Way, 192.168.10.5
    IPReceiveSettings, IPR1, 28785, TCP2Way, 192.168.10.5
COM1>
```

siss giss	setIPServerSettings getIPServerSettings	Cd Cd	Port	Mode	UDPAddress (200)					
		+ IPS1 + IPS2 + IPS3 + IPS4 + IPS5 all	0...65535	TCP UDP TCP2Way	255.255.255.255					

RxControl: Communication > Network Settings > General

By default (*Mode* set to `TCP`), this command defines the TCP/IP port where the receiver's IP Servers (IPS) listen for incoming TCP/IP connections. When a client connects to an IPS port, all output data specified for that port are streamed to the client.

In `TCP` mode, the IPS port is unidirectional: it only sends data and incoming bytes are discarded. The `TCP2Way` mode is the same as the `TCP` mode, except that the receiver will also process input data (such as user commands or differential corrections). An IPS port configured in `TCP2Way` mode can only accept a single client at a time.

When *Mode* is set to `UDP` and *UDPAddress* is set to `255.255.255.255`, the IPS works in UDP broadcast mode. In that mode, the IPS data stream is delivered to any host on the local network listening to the IP port specified by the *Port* argument.

When *Mode* is set to `UDP` and *UDPAddress* contains a whitespace-separated list of IP addresses or hostnames, the IPS data stream is only delivered to the specified hosts. Remember to enclose the *UDPAddress* argument between double quotes when it contains whitespaces.

Use the `setDataInOut` command and the various output setting commands (e.g. `setNMEAOutput`) to define the data stream to be output by the IPS connections. Note that the UDP implementation is meant to be used with small data volumes and low update rates. It is the user's responsibility to only enable short messages at low rate when using UDP, in order to prevent throughput degradation of the network.

It is possible to configure some IPS connections in UDP mode, and others in TCP mode. The *UDPAddress* argument is ignored in TCP mode.



When selecting a port number, make sure to avoid conflicts with other services (for example select a different port than in the `setIPPortSettings` command).

All IPS connections must use different ports. Set the *Port* argument to 0 to disable an IPS connection.

Example

```
COM1> siss, IPS1, 28785, UDP, 255.255.255.255<CR>
$R: siss, IPS1, 28785, UDP, 255.255.255.255
    IPServerSettings, IPS1, 28785, UDP, 255.255.255.255
COM1>
```

sips gips	setIPSettings getIPSettings	Mode	IP (16)	Netmask (16)	Gateway (16)	Domain (63)	DNS1 (16)	DNS2 (16)	MTU
		DHCP Static	0.0.0.0	255.255.255.0	0.0.0.0		0.0.0.0	0.0.0.0	0 ... 1500

RxControl: Communication > Network Settings > General

Use these commands to define the IP (Internet Protocol) settings of the receiver's Ethernet port. By default, the receiver is configured to use DHCP.

In *Static* mode, the receiver will not attempt to request an address via DHCP. It will use the specified IP address, netmask, gateway, domain name and DNS. *DNS1* is the primary DNS, and *DNS2* is the backup DNS. The arguments *IP*, *Netmask*, *Gateway*, *Domain*, *DNS1*, and *DNS2* are ignored in *DHCP* mode.

In *Static* mode, the value of *MTU* is used as the MTU of the Ethernet port. When *MTU* is set to 0, the receiver will use the default MTU. In *DHCP* mode, setting *MTU* to 0 will result in using the MTU supplied by the DHCP server. When set to any other value, *MTU* will override the DHCP Server once the link is established.

The IP settings configured by this command keep their value upon a power cycle and even after a reset to factory default (see command **exeResetReceiver**).

Note that this command is not shown in the output of the **lstConfigFile** command.

The command **getIPSettings** cannot be used to get the current IP address assigned to the receiver by the DHCP server. The current IP address can be retrieved from the command **lstInternalFile**, **IPParameters**, or from the *IPStatus* SBF block.

Example

```
COM1> sips, Static, 192.168.1.123, 255.255.252.0, 192.168.1.255,
      mydomain.local, 192.168.100.3, 192.168.100.4, 1500<CR>
$R: sips, Static, 192.168.1.123, 255.255.252.0, 192.168.1.255,
      mydomain.local, 192.168.100.3, 192.168.100.4, 1500
      IPSettings, Static, 192.168.1.123, 255.255.252.0, 192.168.1.255,
      mydomain.local, 192.168.100.3, 192.168.100.4, 1500
COM1>
```

spe gpe	setPeriodicEcho getPeriodicEcho	Cd Cd	Message (201)	Interval						
		+ COM1 + COM2 + COM3 + COM4 all	A:Unknown	off once msec100 msec200 msec500 sec1 sec2 sec5 sec10 sec15 sec30 sec60 min2 min5 min10 min15 min30 min60						

[RxControl: Communication > Output Settings > Periodic Echo message](#)

Use this command to periodically send a message to one of the connections of the receiver.

The *Message* argument defines the message that should be sent on the *Cd* port. If the given message starts with "A:", the remainder of the message is considered an ASCII string that will be forwarded to the requested connection. All occurrences of the %%CR character sequence are replaced by a single carriage return character (ASCII code 13d) and all occurrences of the %%LF character sequence are replaced by a single line feed character (ASCII code 10d). If the *Message* argument starts with "H:", the remainder of the message is considered a hexadecimal representation of a succession of bytes to be sent to the requested connection. In this case, the string should be a succession of 2-character hexadecimal values separated by a single whitespace.

Make sure to enclose the string between double quotes if it contains whitespaces. The maximum length of the *Message* argument (including the A: or H: prefix) is 201 characters.

The *Interval* argument defines the interval at which the message should be sent.

To send a message only once, set *Interval* to `once`. The only difference with the command **exeEchoMessage** is that **exeEchoMessage** cannot be stored in the boot configuration file, while **setPeriodicEcho** can. This can be used to output a message once at each reset or reboot. The third example below shows how to do this.

Examples

To send the string "Hello!<CR><LF>" to COM2 every minute, use:

```
COM1> spe, COM2, "A:Hello!%%CR%%LF", sec60 <CR>
$R: spe, COM2, "A:Hello!%%CR%%LF", sec60
    PeriodicEcho, COM2, "A:Hello!%%CR%%LF", sec60
COM1>
```

The same can be achieved with the following command:

```
COM1> spe, COM2, "H:48 65 6C 6C 6F 21 0D 0A", sec60 <CR>
$R: spe, COM2, "H:48 65 6C 6C 6F 21 0D 0A", sec60
```

```
    PeriodicEcho, COM2, "H:48 65 6C 6C 6F 21 0D 0A", sec60  
COM1>
```

To let the receiver output the string "Hello!<CR><LF>" to COM2 at each reset, use the following command sequence:

```
COM1> spe, COM2, "A:Hello!%%CR%%LF", once <CR>  
$R: spe, COM2, "A:Hello!%%CR%%LF", once  
    PeriodicEcho, COM2, "A:Hello!%%CR%%LF", once  
COM1> eccf, Current, Boot <CR>  
$R: eccf, Current, Boot  
    CopyConfigFile, Current, Boot  
COM1>
```

sp2p gp2p	setPointToPoint getPointToPoint	SessionID SessionID	Mode	Cd	ClientIP (20)	ServerIP (20)	Auth	Password (40)	ConnectTimeout	ActivityTimeout
		+ P2PP1 all	Off Server	COM1 COM2 COM3 COM4	192.168.50.2	192.168.50.1	None PAP CHAP		60 ... 300 s	10 ... 600 ...32000 s

[RxControl: Communication > Network Settings > P2P Protocol](#)

The receiver features a Point-to-Point Protocol (P2PP) server, which emulates an IP link over a serial port. To avoid confusion with Precise Point Positioning, this feature is referred to as P2PP in Septentrio receivers. This command configures the P2PP server.

In the current version, the receiver implements a single P2PP server, and the first argument (*ServerID*) can only take the value `P2PP1`.

The *Mode* argument enables the P2PP server (it is disabled by default).

Cd sets the COM port to be used for the point-to-point communication. The baud rate and hardware flow control must be configured with the `setCOMSettings` command.

ClientIP sets the IP address that will be given to the client (i.e. your local computer) when a connection is established.

ServerIP sets the IP address that will be given to the server (i.e. the receiver) when a connection is established.

Auth determines whether the client needs to authenticate itself when establishing the connection. `PAP` will use Password Authentication Protocol and `CHAP` will use Challenge Handshake Authentication Protocol. When authentication is enabled, the *Password* argument sets the password that will need to be supplied.

ConnectTimeout sets the maximum time, in seconds, that a connection attempt may consume before being refused.

ActivityTimeout sets the maximum time, in seconds, that a connection may be idle (no data transfer) before it is disconnected.

When a timeout occurs, the receiver will shut down the P2PP server and restart it. When a server is enabled, and the configuration is correct, the receiver will start the P2PP server within a maximum of 30 seconds.

Example

```
COM1> sp2p, P2PP1, Off, COM1, 255.255.255.255, 255.255.255.255,
      None, P@ssw0rd1, 60, 600<CR>
$R: sp2p, P2PP1, Off, COM1, 255.255.255.255, 255.255.255.255, None,
    P@ssw0rd1, 60, 600
    PointToPoint, P2PP1, Off, COM1, 255.255.255.255, 255.255.255.255,
    None, P@ssw0rd1, 60, 600
COM1>
```

spfw gpfw	setPortFirewall getPortFirewall	Interface Interface	OpenPorts	PortList (100)						
		+ Ethernet all	none default all PortList							

[RxControl: Communication > Network Settings > Security](#)

Use this command to configure the receiver firewall, i.e. to specify the list of IP ports which are open to receive data.

The list of open ports can be specified independently for all network interfaces. The default (*OpenPorts* is set to `default`) depends on the interface, as follows:

Interface	Description
Ethernet	By default, all ports open.

It is possible to close all ports (*OpenPorts* is `none`), to open all ports (*OpenPorts* is `all`), or to manually specify a list of ports to open (*OpenPorts* is `PortList`). In the latter case, the list of port numbers needs to be specified in the *PortList* argument. The different port numbers must be separated by whitespaces. The *PortList* argument is ignored if *OpenPorts* is not set to `PortList`.

Example

```
COM1> spfw, Ethernet, PortList, 21 80 28784<CR>
$R: spfw, Ethernet, PortList, 21 80 28784
    PortFirewall, Ethernet, PortList, 21 80 28784
COM1>
```

3.2.13 NTRIP Settings

snmp gnmp	setNtripCasterMountPoints getNtripCasterMountPoints	MountPointID MountPointID	Enable	MPName (32)	ExtServer	UserName (20)	Password (40)	ClientAuth		
		+ MP1 + MP2 + MP3 all	off on		No Yes			none basic		

[RxControl: Communication > NTRIP Settings > NTRIP Caster settings](#)

This command defines the general characteristics of the mount points available on the built-in NTRIP caster. The caster supports up to three mount points.

The *Enable* argument enables or disables a mount point. The *MPName* argument is the mount point name, as it will appear in the stream record of the caster source table. Make sure to give each enabled mount point a different name.

The *ExtServer* argument defines if the mount point is allowed to receive a stream from a remote NTRIP server (argument set to *Yes*), or if only local streams are allowed, i.e. streams originating from the receiver's own NTRIP server. The *UserName* and *Password* arguments are the credentials needed for the remote server to feed data. These arguments are ignored if *ExtServer* is set to *No*.

The *ClientAuth* argument defines the mount point client access protection. If set to *none*, all clients will be able to connect without providing credentials.

Note that the caster is reset each time a setting is changed with this command.

Example

```
COM1> snmp, MP1, on, MyMP, Yes, MyUser, MyPwd, basic<CR>
$R: snmp, MP1, on, MyMP, Yes, MyUser, MyPwd, basic
    NtripCasterMountPoints, MP1, on, MyMP, Yes, MyUser, MyPwd, basic
COM1>
```

smf gmpf	setNtripCasterMPFormat getNtripCasterMPFormat	MountPointID MountPointID	Format	ManualFt (30)	FtDetails (100)					
		+ MP1 + MP2 + MP3 all	RTCMv2 RTCMv3 CMR NMEA <u>RAW</u> manual							

[RxControl: Communication > NTRIP Settings > NTRIP Caster settings](#)

Use this command to define the format of the streams available on the caster mount points.

The *Format* argument defines the stream format, as will be reported in the `<format>` field of the sourcetable STR records. It is possible to select one of the predefined formats, or to enter a user-defined format. The latter is done by setting the *Format* argument to `manual` and by providing the format string with the *ManualFt* argument. The *ManualFt* argument is ignored when *Format* is not set to `manual`.

The *FtDetails* argument sets the contents of the `<format-details>` field of the sourcetable STR records.

When you need a comma in the *ManualFt* or *FtDetails* argument, use the `"%%CM"` escape sequence. Do not forget to enclose the string between double quotes if it contains whitespaces.

Note that the caster is reset each time a stream format is changed with this command.



When feeding a stream to the caster, make sure that the format of the stream corresponds to the settings in this command.

Example

```
COM1> smf, MP1, manual, RAW%%CMNMEA, "SBF (1s)%%CM NMEA (5s)"<CR>
$R: smf, MP1, manual, RAW%%CMNMEA, "SBF (1s)%%CM NMEA (5s)"
    NtripCasterMPFormat, MP1, manual, RAW%%CMNMEA, "SBF (1s)%%CM NMEA
      (5s)"
COM1>
```

sncs gncs	setNtripCasterSettings getNtripCasterSettings	Mode	Port	Identifier (100)	TlsPort					
		off on	0 ... 2101 ... 65535	default	0 ... 2102 ... 65535					

[RxControl: Communication > NTRIP Settings > NTRIP Caster settings](#)

Use this command to enable and configure the built-in NTRIP caster.

The *Port* argument specifies on which IP port the caster can be accessed in "unsecure" mode, and the *TlsPort* specifies on which TLS port the caster can be accessed. The TLS certificate is the same as the https certificate. See the **setHttpsSettings** command for details.

Note that, if *Port* and *TlsPort* are equal, TLS is disabled.

The *Identifier* argument is a free text that can be used to describe the caster. If *Identifier* is set to the string "default", it is replaced by the receiver name and serial number. This text will appear in the "Identifier" field of the caster record in the NTRIP source table.

Example

```
COM1> sncs, on, 2101, default, 2102<CR>
$R: sncs, on, 2101, default, 2102
  NtripCasterSettings, on, 2101, default, 2102
COM1>
```

sncu	setNtripCasterUsers	UserID	UserName (20)	Password (40)	MountPoints	MaxClients				
gncu	getNtripCasterUsers	UserID								
		+ User1 + User2 + User3 + User4 + User5 all			none + MP1 + MP2 + MP3 all	1 ... 10				

[RxControl: Communication > NTRIP Settings > NTRIP Caster settings](#)

This command defines the user accounts (user name and password) that clients can use to connect to the built-in NTRIP caster. The password must contain at least one character (empty passwords are not supported). Up to five user accounts can be defined.

The *MountPoints* argument defines the list of mount points allowed for a given user account.

The caster can accept up to 10 concurrent client connections in total. The *MaxClients* argument can be used to limit the number of clients that are allowed to concurrently connect using a particular account.

To delete a user account, enter this command with an empty *UserName* argument.

Note that the caster is reset each time a user account is added, deleted or modified with this command.

Example

```
COM1> sncu, User1, MyUser, MyPwd, all, 1<CR>
$R: sncu, User1, MyUser, MyPwd, all, 1
    NtripCasterUsers, User1, MyUser, MyPwd, all, 1
COM1>
```

snts gnts	setNtripSettings getNtripSettings	Cd Cd	Mode	Caster (40)	Port	UserName (20)	Password (40)	MountPoint (32)	Version	SendGGA
		+NTR1 +NTR2 +NTR3 +NTR4 all	off Server Client		0...2101 ...65535				v1 v2	auto off sec1 sec5 sec10 sec60

RxControl: Communication > NTRIP Settings > NTRIP Server/Client settings

Use this command to specify the parameters of the NTRIP connection referenced by the *Cd* argument.

The *Mode* argument specifies the type of NTRIP connection. In *Server* mode, the receiver is sending data to an NTRIP caster. In *Client* mode, the receiver gets data from the NTRIP caster. Set *Mode* to *off* to disable the connection.

Caster is the hostname or IP address of the NTRIP caster to connect to. To send data to the built-in NTRIP caster, use "localhost" for the *Caster* argument. *Port*, *UserName*, *Password* and *MountPoint* are the IP port number, the user name, the password and the mount point to be used when connecting to the NTRIP caster. The default NTRIP port number is 2101. Note that the receiver encrypts the password so that it cannot be read back with the command **getNtripSettings**.

The *Version* argument specifies which version of the NTRIP protocol to use (v1 or v2).

The *SendGGA* argument specifies whether or not to send NMEA GGA messages to the NTRIP caster, and at which rate. In *auto* mode (the default), the receiver automatically sends GGA messages if requested by the caster. This argument is ignored in NTRIP server mode.

Example

```
COM1> snts, NTR1, Client, ntrip.com, 2101, USER, PWD, MP1, v2,
      auto<CR>
$R: snts, NTR1, Client, ntrip.com, 2101, USER, PWD, MP1, v2, auto
      NtripSettings, NTR1, Client, ntrip.com, 2101, USER, PWD, MP1, v2,
      auto
COM1>
```

Inst	IstNTRIPSourceTable	Caster (40)	Port							
			0...2101 ...65535							

Use this command to retrieve the source table from the specified NTRIP caster.

Caster is the hostname or IP address of the NTRIP caster to connect to, and *Port* is the IP port number. The default NTRIP port number is 2101.

Example

```
COM1> inst, ntripcaster <CR>
$R; inst, ntripcaster
---->
$-- BLOCK 1 / 0 C
HTTP/1.1 200 OK
Ntrip-Version: Ntrip/2.0
Ntrip-Flags: st_filter,st_auth,st_match,st_strict
Server: NTRIP Caster/2.0.15
...
$-- BLOCK 1 / 0 C
ENDSOURCETABLE
COM1>
```

snrt gnrt	setNtripTlsSettings getNtripTlsSettings	Cd Cd	Enable	Fingerprint (96)						
		+NTR1 +NTR2 +NTR3 +NTR4 all	off on							

[RxControl: Communication > NTRIP Settings > NTRIP Server/Client settings](#)

Use this command to enable or disable TLS on the NTRIP connection referenced by the *Cd* argument.

If the caster's certificate is known by a publicly-trusted certification authority (CA), the receiver will authenticate it by following the usual CA chain of trust, starting from root certificates present on the receiver. In that case, the *Fingerprint* argument should be left empty. If the NTRIP caster uses a self-signed certificate or a certificate only known by a private CA, its SHA-256 fingerprint must be provided. The self-signed certificate of the built-in caster (localhost) is present in the trust-zone of the receiver, and so the *Fingerprint* argument can be left empty for NTRIP client or server connections to localhost.

The examples below show different formats for the *Fingerprint* argument.

Examples

```
COM1> snrt, NTR1, on, ""<CR>
$R: snrt, NTR1, on, ""
    NtripTlsSettings, NTR1, on, ""
COM1>
```

Lower and upper case characters are allowed:

```
COM1> snrt, NTR1, on, Aa:Bb:56:78:90:12: ... 78:90:12:34 <CR>
$R: snrt, NTR1, on, Aa:Bb:56:78:90:12: ... 78:90:12:34
    NtripTlsSettings, NTR1, on, "AA:BB:56:78:90:12: ... 78:90:12:34"
COM1>
```

When using whitespaces as delimiter, do not forget to enclose the fingerprint in double quotes:

```
COM1> snrt, NTR1, on, "Aa Bb 56 78 90 12 ... 78 90 12 34"<CR>
$R: snrt, NTR1, on, "Aa Bb 56 78 90 12 ... 78 90 12 34"
    NtripTlsSettings, NTR1, on, "AA:BB:56:78:90:12: ... 78:90:12:34"
COM1>
```

It is also allowed to leave out the delimiters in the fingerprint:

```
COM1> snrt, NTR1, on, AaBb56789012 ... 78901234 <CR>
$R: snrt, NTR1, on, AaBb56789012 ... 78901234
    NtripTlsSettings, NTR1, on, "AA:BB:56:78:90:12: ... 78:90:12:34"
COM1>
```

3.2.14 NMEA Configuration

enoc gnoc	exeNMEAOnce getNMEAOnce	Cd	Messages						
		DSK1	+ALM						
		COM1	+DTM						
		COM2	+GBS						
		COM3	+GGA						
		COM4	+GLL						
		USB1	+GNS						
		USB2	+GRS						
		IP10 ... IP17	+GSA						
		NTR1	+GST						
		NTR2	+GSV						
		NTR3	+HDT						
		NTR4	+RMC						
		IPS1	+ROT						
		IPS2	+VTG						
		IPS3	+ZDA						
		IPS4	+HRP						
		IPS5	+LLQ						
		IPR1	+RBP						
		IPR2	+RBV						
		IPR3	+RBD						
		IPR4	+AVR						
		IPR5	+GGK						
			+GFA						
			+GGQ						
			+LLK						
			+GMP						
			+TFM						
			+SNC						
			+THS						

RxControl: Communication > Output Settings > NMEA Output Once

Use this command to output a set of NMEA messages on a given connection. This command differs from the related **setNMEAOutput** command in that it instructs the receiver to output the specified messages only once, instead of at regular intervals.

The *Cd* argument defines the connection descriptor (see 1.1.5) on which the message(s) should be output and the *Messages* argument defines the list of messages that should be output. Refer to appendix C for a short description of the NMEA sentences.

Please make sure that the connection specified by *Cd* is configured to allow NMEA output (this is the default for all connections). See the **setDataInOut** command.

Example

To output the receiver position on COM1, use:

```
COM1> enoc, COM1, GGA <CR>
$R: enoc, COM1, GGA
  NMEAOnce, COM1, GGA
COM1>
```

sno gno	setNMEAOutput getNMEAOutput	Stream Stream	Cd	Messages	Interval				
		+ Stream1 ... Stream10 all	none DSK1 COM1 COM2 COM3 COM4 USB1 USB2 IP10 ... IP17 NTR1 NTR2 NTR3 NTR4 IPS1 IPS2 IPS3 IPS4 IPS5 IPR1 IPR2 IPR3 IPR4 IPR5	none + ALM + DTM + GBS + GGA + GLL + GNS + GRS + GSA + GST + GSV + HDT + RMC + ROT + VTG + ZDA + HRP + LLQ + RBP + RBV + RBD + AVR + GGK + GFA + GGQ + LLK + GMP + TXTbase + TFM + SNC + THS	off OnChange msec10 msec20 msec40 msec50 msec100 msec200 msec500 sec1 sec2 sec5 sec10 sec15 sec30 sec60 min2 min5 min10 min15 min30 min60				

[RxControl: Communication > Output Settings > NMEA Output > NMEA Output Intervals](#)

Use this command to output a set of NMEA messages on a given connection at a regular interval. The *Cd* argument defines the connection descriptor (see 1.1.5) on which the message(s) should be output and the *Messages* argument defines the list of messages that should be output. Refer to appendix C for a short description of the NMEA sentences.

This command is the counterpart of the **setSBFOutput** command for NMEA sentences. Please refer to the description of that command for a description of the arguments.

Examples

To output GGA at 1Hz and RMC at 10Hz on COM1, use:

```
COM1> sno, Stream1, COM1, GGA, sec1 <CR>
$R: sno, Stream1, COM1, GGA, sec1
    NMEAOutput, Stream1, COM1, GGA, sec1
COM1> sno, Stream2, COM1, RMC, msec100 <CR>
$R: sno, Stream2, COM1, RMC, msec100
    NMEAOutput, Stream2, COM1, RMC, msec100
COM1>
```

To get the list of NMEA messages currently output, use:

```
COM1> gno <CR>
$R: gno
    NMEAOutput, Stream1, COM1, GGA, sec1
```

```
NMEAOutput, Stream2, COM1, RMC, msec100  
NMEAOutput, Stream3, none, none, off  
NMEAOutput, Stream4, none, none, off  
NMEAOutput, Stream5, none, none, off  
NMEAOutput, Stream6, none, none, off  
NMEAOutput, Stream7, none, none, off  
NMEAOutput, Stream8, none, none, off  
NMEAOutput, Stream9, none, none, off  
NMEAOutput, Stream10, none, none, off  
COM1>
```

snp gnp	setNMEAPrecision getNMEAPrecision	NrExtraDigits	Compatibility	LocalDatum	MinStdDev					
		0...2...3	Nominal Mode1 Mode2	off only	0.000...0.001 ... 1.000 m					

[RxControl: Communication > Output Settings > NMEA Output > Customize](#)

Use these commands to define/inquire the number of extra digits in the latitude, longitude and altitude reported in NMEA sentences and to tune certain sentences to be compatible with third-party applications that are not fully compliant with the NMEA 0183 standard.

When *NrExtraDigits* is 0, the latitude and longitude are reported in degrees with 5 decimal digit, and altitude is reported in meters with 2 decimal digit. These default numbers of digits lead to a centimeter-level resolution of the position. To represent RTK positions with their full precision (millimeter-level), it is recommended to set *NrExtraDigits* to 2.

Note that increasing the number of digits (setting *NrExtraDigits* to a non-zero value) may cause the NMEA standard to be broken, as the total number of characters in a sentence may end up exceeding the prescribed limit of 82.

When setting the argument *Compatibility* to *Mode1*, the GPS Quality Indicator in GGA sentences is set to the value "2: Differential GPS" for all non-standalone positioning modes, the Mode Indicator in GNS sentences is set to "D: Differential" for all non-standalone positioning modes, and the Course Over Ground in the VTG sentences is not a null field for stationary receivers.

When setting the argument *Compatibility* to *Mode2*, the Course Over Ground in the VTG sentences is not a null field for stationary receivers.

The *LocalDatum* argument specifies whether transformation parameters sent out by the RTK service provider should be applied or not in NMEA sentences GGA and GNS. If *LocalDatum* is *off*, the transformation parameters are not applied, and the coordinates in GGA and GNS correspond to the coordinates in the *PVTGeodetic* SBF block. If *LocalDatum* is *only* and the relevant transformation parameters have been received, the coordinates are transformed to the local datum and correspond to the *PosLocal* SBF block. If the transformation parameters are not available, the coordinates are untransformed (in particular, the datum setting of the *setGeodeticDatum* command has no effect). The TFM proprietary NMEA sentence can be used to determine which transformation has been applied.

The *MinStdDev* argument defines the minimum standard deviation values that can be encoded in the GST sentence. If an actual standard deviation is below the value provided in *MinStdDev*, the value in *MinStdDev* is encoded instead.

Example

```
COM1> snp, 2, Mode2, off, 0.05<CR>
$R: snp, 2, Mode2, off, 0.05
  NMEAPrecision, 2, Mode2, off, 0.050
COM1>
```

snti	setNMEATalkerID	<i>TalkerID</i>								
gnti	getNMEATalkerID									
		auto GP GN								

[RxControl: Communication > Output Settings > NMEA Output > Customize](#)

Use these commands to define/inquire the "Device Talker" for NMEA sentences. The device talker allows users to identify the type of equipment from which the NMEA sentence was issued.

When the *TalkerID* argument is set to `auto`, the talker will depend on the type of solution that is output. For a GNSS solution, "GN" is used if satellites from multiple constellations are used, "GP" for a GPS only solution, "GA" for a Galileo only solution, and "BD" for a BeiDou only solution.

Note that the command is ignored for the NMEA sentences where it would conflict with the standard. For example, the GSV sentence reporting the GPS visibility will always have its device talker set to "GP" regardless of the **setNMEATalkerID** command.

Example

```
COM1> snti, GP <CR>
$R: snti, GP
    NMEATalkerID, GP
COM1>
```

snv	setNMEAVersion	<i>Version</i>								
gnv	getNMEAVersion									
		v3x v4x								

RxControl: Communication > Output Settings > NMEA Output > Customize

Use this command to set the NMEA version the receiver should comply with.

If v3x is selected, the NMEA sentences are formatted according to the 3.01 version of the standard. If v4x is selected, system ID, signal ID and navigational status fields are added in some sentences according to version 4.10 of the NMEA standard.

Example

```
COM1> snv, v4x<CR>
$R: snv, v4x
  NMEAVersion, v4x
COM1>
```

3.2.15 SBF Configuration

smrf	setMeas3MaxRefInterval	MaxIntrvl								
gmr	getMeas3MaxRefInterval									
		OnlyRef								
		msec500								
		sec1								
		sec5								
		sec10								
		sec30								
		sec60								

[RxControl: Communication > Output Settings > SBF Output > Customize](#)

Use this command to define at which interval to encode reference epochs (i.e. full measurements) into the `Meas3Ranges` SBF block. Refer to the description of the `Meas3Ranges` block for a definition of the reference epochs.

When generating the `Meas3Ranges` SBF block, the receiver automatically selects an optimal interval between reference epochs. This command allows the user to define the maximum interval allowed for his application. Setting the `MaxIntrvl` argument to `OnlyRef` forces the receiver to only encode reference epochs in `Meas3Ranges`. This will allow to decode all epochs independently of any previous epoch, at the expense of a larger average SBF block size.

Example

```
COM1> smrf, OnlyRef<CR>
$R: smrf, OnlyRef
    Meas3MaxRefInterval, OnlyRef
COM1>
```

ssgp gsgp	setSBFGroups getSBFGroups	Group Group	Messages						
		+ Group1	none						
		+ Group2	[SBF List]						
		+ Group3	+ Measurements						
		+ Group4	+ Meas3						
		all	+ RawNavBits						
			+ GPS						
			+ GLO						
			+ GAL						
			+ GEO						
			+ BDS						
			+ QZS						
			+ PVTCart						
			+ PVTGeod						
			+ PVTExtra						
			+ Attitude						
			+ Time						
			+ Events						
			+ DiffCorr						
			+ Status						
			+ LBand						
			+ PostProcess						
			+ Rinex						
			+ RinexMeas3						
			+ Support						

[RxControl: Communication > Output Settings > SBF Groups](#)

Use these commands to define/inquire user-defined groups of SBF blocks that can be re-used in the **exeSBFOnce** and the **setSBFOutput** commands. The purpose of defining groups is to ease the typing effort when the same set of SBF blocks are to be addressed regularly.

The list of supported SBF blocks [SBF List] can be found in appendix B.

A number of predefined groups of SBF blocks are available (such as `Measurements`). See the command **setSBFOutput** for a description of these predefined groups.

Example

To output the messages `MeasEpoch`, `PVTCartesian` and `DOP` as one group on COM1 at a rate of 1Hz, you could use the following sequence of commands:

```
COM1> ssgp, Group1, MeasEpoch+PVTCartesian+DOP <CR>
$R: ssgp, Group1, MeasEpoch+PVTCartesian+DOP
    SBFGroups, Group1, MeasEpoch+PVTCartesian+DOP
COM1> sso, Stream1, COM1, Group1, sec1 <CR>
$R: sso, Stream1, COM1, Group1, sec1
    SBFOutput, Stream1, COM1, Group1, sec1
COM1>
```

esoc gsoc	exeSBFOnce getSBFOnce	Cd	Messages							
		DSK1	[SBF List]							
		COM1	+ Measurements							
		COM2	+ Meas3							
		COM3	+ GPS							
		COM4	+ GLO							
		USB1	+ GAL							
		USB2	+ GEO							
		IP10 ... IP17	+ BDS							
		NTR1	+ QZS							
		NTR2	+ PVTCart							
		NTR3	+ PVTGeod							
		NTR4	+ PVTEtra							
		IPS1	+ Attitude							
		IPS2	+ Time							
		IPS3	+ Status							
		IPS4	+ LBand							
		IPS5	+ UserGroups							
		IPR1	+ PostProcess							
		IPR2	+ Rinex							
		IPR3	+ RinexMeas3							
		IPR4	+ Support							
		IPR5								

[RxControl: Communication > Output Settings > SBF Output Once](#)

Use this command to output a set of SBF blocks on a given connection. This command differs from the related **setSBFOutput** command in that it instructs the receiver to output the specified SBF blocks only once, instead of at regular intervals.

The *Cd* argument defines the connection descriptor (see 1.1.5) on which the message(s) should be output and the *Messages* argument defines the list of messages that should be output. The list of SBF blocks [SBF List] supported by the **exeSBFOnce** command can be found in appendix B.

Make sure that the connection specified by *Cd* is configured to allow SBF output (this is the default for all connections). See also the **setDataInOut** command.

Predefined groups of SBF blocks (such as *Measurements*) can be addressed in the *Messages* argument. These groups are defined in the table below.

When using this command to output a block that is also scheduled with the **setSBFOutput** command, the block will be sent twice. Note that this can cause duplicate measurement or PVT epochs in the SBF stream.

Messages	Description
Measurements	+MeasEpoch +MeasExtra +EndOfMeas
Meas3	+Meas3Ranges +Meas3CN0HiRes +Meas3Doppler +Meas3PP +Meas3MP
GPS	+GPSNav +GPSAlm +GPSIon +GPSUtc
GLO	+GLONav +GLOAlm +GLOTTime
GAL	+GALNav +GALAlm +GALIon +GALUtc +GALGstGps
GEO	+GEONav +GEOAlm
BDS	+BDSAlm +BDSNav +BDSIon +BDSUtc
QZS	+QZSNav +QZSAlm

Messages (Continued)	Description
PVTCart	+PVTCartesian +PosCovCartesian +VelCovCartesian +BaseVectorCart
PVTGeod	+PVTGeodetic +PosCovGeodetic +VelCovGeodetic +BaseVectorGeod +PosLocal
PVTEExtra	+DOP +PVTSupport +PVTSupportA +EndOfPVT
Attitude	+AttEuler +AttCovEuler +EndOfAtt
Time	+ReceiverTime
Status	+SatVisibility +ChannelStatus +ReceiverStatus +InputLink +OutputLink +IPStatus +NTRIPClientStatus +NTRIPServerStatus +CosmosStatus +QualityInd +DiskStatus +RFStatus +DynDNSStatus +P2PPStatus
LBand	+LBandTrackerStatus +LBandBeams
UserGroups	+Group1 +Group2 +Group3 +Group4
PostProcess	+MeasEpoch +MeasExtra +GPSNav +GPSIon +GPSUtc +GLONav +GLOTime +GALNav +GALIon +GALUtc +GALGstGps +GEONav +BDSNav +BDSIon +BDSUtc +QZSNav +ReceiverSetup +Commands
Rinex	+MeasEpoch +GPSNav +GPSIon +GPSUtc +GLONav +GALNav +GALUtc +GALGstGps +GEONav +BDSNav +QZSNav +PVTGeodetic +ReceiverSetup +Comment
RinexMeas3	+Meas3Ranges +GPSNav +GPSIon +GPSUtc +GLONav +GALNav +GALUtc +GALGstGps +GEONav +BDSNav +QZSNav +ReceiverSetup +Comment
Support	+MeasEpoch +MeasExtra +EndOfMeas +GPSNav +GPSAlm +GPSIon +GPSUtc +GLONav +GLOAlm +GLOTime +GALNav +GALAlm +GALIon +GALUtc +GALGstGps +GEONav +GEOAlm +BDSAlm +BDSNav +BDSIon +BDSUtc +QZSNav +PVTGeodetic +PosCovGeodetic +BaseVectorGeod +AttEuler +DOP +PVTSupport +PVTSupportA +EndOfPVT +ChannelStatus +ReceiverStatus +InputLink +OutputLink +ReceiverSetup +Commands +RxMessage +LBandTrackerStatus +IPStatus +NTRIPClientStatus +NTRIPServerStatus +CosmosStatus +QualityInd +LBandBeams +DiskStatus +RFStatus +DynDNSStatus +P2PPStatus

Example

To output the next MeasEpoch block, use:

```
COM1> esoc, COM1, MeasEpoch <CR>
$R: esoc, COM1, MeasEpoch
    SBFOnce, COM1, MeasEpoch
COM1>
```

SSO gso	setSBFOutput getSBFOutput	Stream Stream	Cd	Messages	Interval				
		+ Stream1 ... Stream10	none	none	off				
		+ Res1	DSK1	[SBF List]	OnChange				
		+ Res2	COM1	+ Measurements	msec10				
		+ Res3	COM2	+ Meas3	msec20				
		+ Res4	COM3	+ RawNavBits	msec40				
		all	COM4	+ GPS	msec50				
			USB1	+ GLO	msec100				
			USB2	+ GAL	msec200				
			IP10 ... IP17	+ GEO	msec500				
			NTR1	+ BDS	sec1				
			NTR2	+ QZS	sec2				
			NTR3	+ PVTCart	sec5				
			NTR4	+ PVTGeod	sec10				
			IPS1	+ PVTExtra	sec15				
			IPS2	+ Attitude	sec30				
			IPS3	+ Time	sec60				
			IPS4	+ Event	min2				
			IPS5	+ DiffCorr	min5				
			IPR1	+ Status	min10				
			IPR2	+ LBand	min15				
			IPR3	+ UserGroups	min30				
			IPR4	+ PostProcess	min60				
			IPR5	+ Rinex					
				+ RinexMeas3					
				+ Support					

[RxControl: Communication > Output Settings > SBF Output > SBF Output](#)

Use this command to output a set of SBF blocks on a given connection at a regular interval.

A *Stream* is defined as a list of messages that should be output with the same interval on one connection descriptor (*Cd* - see 1.1.5). In other words, one *Stream* is associated with one *Cd* and one *Interval*, and contains a list of SBF blocks defined by the *Messages* argument.

The list of supported SBF blocks [SBF List] can be found in appendix B.

Predefined groups of SBF blocks (such as *Measurements*) can be addressed in the *Messages* argument. These groups are defined in the table below.

Messages	Description
Measurements	+MeasEpoch +MeasExtra +EndOfMeas
Meas3	+Meas3Ranges +Meas3CN0HiRes +Meas3Doppler +Meas3PP +Meas3MP
RawNavBits	+GPSRawCA +GPSRawL2C +GPSRawL5 +GLORawCA +GALRawFNAV +GALRawINAV +GEORawL1 +GEORawL5 +BDSRaw +BDSRawB1C +BDSRawB2a +NAVICRaw +QZSRawL1CA +QZSRawL2C +QZSRawL5
GPS	+GPSNav +GPSAlm +GPSIon +GPSUtc
GLO	+GLONav +GLOAlm +GLOTime
GAL	+GALNav +GALAlm +GALIon +GALUtc +GALGstGps +GALSARRLM

Messages (Continued)	Description
GEO	+GEO MT00 +GEO PRNMask +GEO FastCorr +GEO Integrity +GEO FastCorrDegr +GEO Nav +GEO DegrFactors +GEO NetworkTime +GEO Alm +GEO IGPMask +GEO LongTermCorr +GEO IonDelay +GEO ServiceLevel +GEO ClockEphCovMatrix
BDS	+BDS Alm +BDS Nav +BDS Ion +BDS Utc
QZS	+QZS Nav +QZS Alm
PVTCart	+PVT Cartesian +PosCovCartesian +VelCovCartesian +BaseVectorCart
PVTGeod	+PVT Geodetic +PosCovGeodetic +VelCovGeodetic +BaseVectorGeod +PosLocal
PVTExtra	+DOP +PVT Support +PVT SupportA +EndOfPVT
Attitude	+Att Euler +Att CovEuler +EndOfAtt
Time	+ReceiverTime +xPPSOffset
Event	+ExtEvent +ExtEventPVTCartesian +ExtEventPVTGeodetic +ExtEventBaseVectGeod +ExtEventAttEuler
DiffCorr	+DiffCorrIn +BaseStation +RTCM Datum
Status	+SatVisibility +ChannelStatus +ReceiverStatus +InputLink +OutputLink +IPStatus +NTRIPClientStatus +NTRIPServerStatus +CosmosStatus +QualityInd +DiskStatus +RFStatus +DynDNSStatus +P2PPStatus
LBand	+LBandTrackerStatus +LBandBeams
UserGroups	+Group1 +Group2 +Group3 +Group4
PostProcess	+MeasEpoch +MeasExtra +GEORawL1 +GPSNav +GPSIon +GPSUtc +GLONav +GLOTime +GALNav +GALIon +GALUtc +GALGstGps +GEONav +BDSNav +BDSIon +BDSUtc +QZSNav +DiffCorrIn +ReceiverSetup +Commands +ExtEvent
Rinex	+MeasEpoch +GPSNav +GPSIon +GPSUtc +GLONav +GALNav +GALUtc +GALGstGps +GEONav +BDSNav +QZSNav +PVTGeodetic +ReceiverSetup +Comment
RinexMeas3	+Meas3Ranges +GPSNav +GPSIon +GPSUtc +GLONav +GALNav +GALUtc +GALGstGps +GEONav +BDSNav +QZSNav +ReceiverSetup +Comment

Messages (Continued)	Description
Support	+MeasEpoch +MeasExtra +EndOfMeas +GPSRawCA +GPSRawL2C +GPSRawL5 +GLORawCA +GALRawFNAV +GALRawINAV +GEORawL1 +GEORawL5 +BDSRaw +BDSRawB1C +BDSRawB2a +NAVICRaw +QZSRawL1CA +QZSRawL2C +QZSRawL5 +GPSNav +GPSAlm +GPSIon +GPSUtc +GLONav +GLOAlm +GLOTime +GALNav +GALAlm +GALIon +GALUtc +GALGstGps +GEONav +GEOAlm +BDSAlm +BDSNav +BDSIon +BDSUtc +QZSNav +QZSAlm +PVTGeodetic +PosCovGeodetic +BaseVectorGeod +AttEuler +DOP +PVTSupport +PVTSupportA +EndOfPVT +ExtEvent +DiffCorrIn +BaseStation +ChannelStatus +ReceiverStatus +InputLink +OutputLink +ReceiverSetup +Commands +RxMessage +LBandTrackerStatus +IPStatus +NTRIPClientStatus +NTRIPServerStatus +CosmosStatus +QualityInd +LBandBeams +DiskStatus +RFStatus +DynDNSStatus +P2PPStatus

The *Interval* argument defines the rate at which the SBF blocks specified in the *Messages* argument are output. If set to `off`, the SBF blocks are disabled. If set to `OnChange`, the SBF blocks are output at their natural renewal rate (see section 4.1.8). If a specific interval is specified (e.g. `sec1` corresponds to an interval of 1 second), the SBF blocks are decimated from their renewal rate to the specified interval. Some blocks can only be output at their renewal rate (e.g. the `GPSNav` block). For these blocks, the receiver ignores the value of the *Interval* argument and always assumes `OnChange`. The list of those blocks can be found in appendix B (see the "Flex Rate" column).

Please make sure that the connection specified by *Cd* is configured to allow SBF output (this is the default for all connections). See the `setDataInOut` command.

`Res1` to `Res4` are reserved values of *Stream*. These streams are not saved in the configuration files and, as a consequence, they will always be reset at boot time. For most users, it is not recommended to use these streams.

Example

To output the `MeasEpoch` block at 10Hz and the `PVTGeodetic` block at 1Hz on COM1, use the following sequence:

```
COM1> sso, Stream1, COM1, MeasEpoch, msec100 <CR>
$R: sso, Stream1, COM1, MeasEpoch, msec100
    SBFOutput, Stream1, COM1, MeasEpoch, msec100
COM1> sso, Stream2, COM1, PVTGeodetic, sec1 <CR>
$R: sso, Stream2, COM1, PVTGeodetic, sec1
    SBFOutput, Stream2, COM1, PVTGeodetic, sec1
COM1>
```

3.2.16 RTCM v2.x Settings

sr2c	setRTCMv2Compatibility	PRCType	GLOToD	RTKVersion						
gr2c	getRTCMv2Compatibility	Standard GroupDelay	Tk Tb	v2.1 v2.2orLater						

[RxControl: Communication > Input Settings > Differential Corrections > RTCMv2](#)

Use these commands to define/inquire the compatibility of the RTCM 2.x input correction stream. This command applies to rover receivers only and should be used in case the available base station correction stream is not fully compatible with the latest version of the RTCM 2.x standard.

The *PRCType* argument is used to handle a difference in the interpretation of DGPS corrections between the version 2.0 of the RTCM standard and later versions. If the base station is sending RTCM Message Type 1 based on version 2.0, the value `GroupDelay` must be selected to have a correct usage of incoming corrections.

The *GLOToD* argument specifies how to interpret the time-of-day field in the differential GLONASS correction message (MT31). Select `Tb` to be compatible with RTCM version up to 2.2, and select `Tk` to be compatible with RTCM 2.3 and later.

The *RTKVersion* argument specifies if the base station encodes RTK correction messages (MT18 to MT21) according to version 2.1 of the RTCM standard, or according to version 2.2 or above.

Example

To make to rover receiver compatible with a base station sending RTCM 2.2 corrections, use:

```
COM1> sr2c, , Tb <CR>
$R: sr2c, , Tb
    RTCMv2Compatibility, Standard, Tb, v2.2orLater
COM1>
```

sr2f gr2f	setRTCMv2Formatting getRTCMv2Formatting	ReferenceID	GLOToD							
		0...1023	Tk Tb							

[RxControl: Communication > Output Settings > Differential Corrections > RTCMv2](#)

Use these commands to define/inquire the reference station ID assigned to the receiver when operating in base station mode. The reference station ID is transmitted in the first word of each outgoing RTCM v2.x message.

The argument *GLOToD* specifies how to encode the time-of-day field in the differential GLONASS correction message (MT31). Select *Tb* to be compatible with RTCM version up to 2.2, and select *Tk* to be compatible with RTCM 2.3 and later.

Examples

```
COM1> sr2f, 345 <CR>
$R: sr2f, 345
    RTCMv2Formatting, 345, Tk
COM1>
```

```
COM1> gr2f <CR>
$R: gr2f
    RTCMv2Formatting, 345, Tk
COM1>
```

sr2i gr2i	setRTCMv2Interval getRTCMv2Interval	Message Message	ZCount							
		+ RTCM1 + RTCM3 + RTCM9 + RTCM16 + RTCM17 + RTCM22 + RTCM23 24 + RTCM31 + RTCM32 all	1...2...1000							

[RxControl: Communication > Output Settings > Differential Corrections > RTCMv2](#)

Use these commands to define/inquire at which interval the RTCM v2.x messages specified in the *Message* argument should be generated. The related **setRTCMv2IntervalObs** command must be used to specify the interval of some RTK-related messages such as messages 18 and 19.

The interval for every message is given in the *ZCount* argument, in units of 0.6 seconds. For example, to generate a message every 6 seconds, *ZCount* should be set to 10.

For the ephemerides message (RTCM17), the ephemerides are sent out one satellite at a time, at a rate specified by this command. For instance, if *ZCount* is set to 1 and there are 12 ephemerides to send out, it takes $0.6 \times 12 = 7.2$ seconds to send the whole ephemerides set.

The intervals specified with this command are not connection-specific: all the connections which output a given RTCM v2.x message will output it with the same interval.

Note that this command only defines the interval of RTCM messages. To make the receiver actually output these messages, use the **setRTCMv2Output** and **setDataInOut** commands.

Refer to appendix D for an overview of the supported RTCM v2.x messages.

Examples

```
COM1> sr2i, RTCM22, 15 <CR>
```

```
$R: sr2i, RTCM22, 15  
    RTCMv2Interval, RTCM22, 15
```

```
COM1>
```

```
COM1> gr2i <CR>
```

```
$R: gr2i  
    RTCMv2Interval, RTCM1, 2  
    RTCMv2Interval, RTCM3, 2  
    RTCMv2Interval, RTCM16, 2  
    RTCMv2Interval, RTCM22, 15  
    RTCMv2Interval, RTCM23|24, 2
```

```
COM1>
```

sr2b gr2b	setRTCMv2IntervalObs getRTCMv2IntervalObs	Message Message	Interval							
		+RTCM18 19 +RTCM20 21 all	1...600 s							

[RxControl: Communication](#) > [Output Settings](#) > [Differential Corrections](#) > [RTCMv2](#)

Use these commands to define/inquire at which interval the RTCM v2.x messages specified in the *Message* argument should be generated. The related **setRTCMv2Interval** command must be used to specify the interval of other supported RCTCM v2.x messages.

The intervals specified with this command are not connection-specific: all the connections which output a given RTCM v2.x message will output it with the same interval.

Note that this command only defines the interval of RTCM messages. To make the receiver actually output these messages, use the **setRTCMv2Output** and **setDataInOut** commands.

Examples

```
COM1> sr2b, RTCM20|21, 2 <CR>
$R: sr2b, RTCM20|21, 2
    RTCMv2IntervalObs, RTCM20|21, 2
COM1>
```

```
COM1> gr2b <CR>
$R: gr2b
    RTCMv2IntervalObs, RTCM18|19, 1
    RTCMv2IntervalObs, RTCM20|21, 2
COM1>
```

sr2m	setRTCMv2Message16	<i>Message (90)</i>								
gr2m	getRTCMv2Message16									
		<u>Unknown</u>								

[RxControl: Communication](#) > [Output Settings](#) > [Differential Corrections](#) > [RTCMv2](#)

Use these commands to define/inquire the string that will be transmitted in the RTCM v2.x message 16. The argument *Message* can contain up to 90 characters.

Note that this command only defines the content of message 16. To make the receiver actually output this message, use the **setRTCMv2Output** and **setDataInOut** commands.

Example

To send the string "Hello" in message 16 over COM2 at the default interval, use the following sequence:

```
COM1> sr2m, Hello <CR>
$R: sr2m, Hello
    RTCMv2Message16, "Hello"
COM1> sr2o, COM2, RTCM16 <CR>
$R: sr2o, COM2, RTCM16
    RTCMv2Output, COM2, RTCM16
COM1> sdio, COM2, , RTCMv2 <CR>
$R: sdio, COM2, , RTCMv2
    DataInOut, COM2, auto, RTCMv2
COM1>
```

sr2o gr2o	setRTCMv2Output getRTCMv2Output	Cd Cd	Messages						
		+COM1	none						
		+COM2	+RTCM1						
		+COM3	+RTCM3						
		+COM4	+RTCM9						
		+USB1	+RTCM16						
		+USB2	+RTCM18 19						
		+IP10 ... IP17	+RTCM20 21						
		+NTR1	+RTCM22						
		+NTR2	+RTCM23 24						
		+NTR3	+RTCM31						
		+NTR4	+RTCM32						
		+IPS1	+RTCM17						
		+IPS2	+DGPS						
		+IPS3	+RTK						
		+IPS4	all						
		+IPS5							
		+IPR1							
		+IPR2							
		+IPR3							
		+IPR4							
		+IPR5							
		all							

[RxControl: Communication > Output Settings > Differential Corrections > RTCMv2](#)

Use these commands to define/inquire which RTCM v2.x messages are enabled for output on a given connection descriptor (*Cd* - see 1.1.5). The *Messages* argument specifies the RTCM message types to be enabled. Some pairs of messages are always enabled together, such as messages 18 and 19. DGPS is an alias for "RTCM1+RTCM3+RTCM31" and RTK is an alias for "RTCM3+RTCM18|19+RTCM22+RTCM31".

Refer to appendix D for an overview of the supported RTCM v2.x messages.

Please make sure that the connection specified by *Cd* is configured to allow RTCMv2 output, which can be done with the **setDataInOut** command. The interval at which each message is output is to be specified with the **setRTCMv2Interval** or the **setRTCMv2IntervalObs** command.

Example

To enable RTCM v2.x messages 3, 18, 19 and 22 on COM2, use the following sequence:

```
COM1> sr2o, COM2, RTCM3+RTCM18|19+RTCM22 <CR>
$R: sr2o, COM2, RTCM3+RTCM18|19+RTCM22
    RTCMv2Output, COM2, RTCM3+RTCM18|19+RTCM22
COM1> sdio, COM2, , RTCMv2 <CR>
$R: sdio, COM2, , RTCMv2
    DataInOut, COM2, auto, RTCMv2
COM1>
```

sr2u gr2u	setRTCMv2Usage getRTCMv2Usage	MsgUsage								
		none + RTCM1 + RTCM3 + RTCM9 + RTCM15 + RTCM18 19 + RTCM20 21 + RTCM22 + RTCM23 24 + RTCM31 + RTCM32 + RTCM34 + RTCM17 + RTCM59 all								

[RxControl: Communication > Input Settings > Differential Corrections > RTCMv2](#)

Use this command to restrict the list of incoming RTCM v2.x messages that the receiver is allowed to use in its differential PVT computation.

A short description of the supported RTCM v2.x messages can be found in appendix D.

Example

To only accept RTCM1 and RTCM3 corrections from the base station 1011, use the following sequence:

```

COM1> sr2u, RTCM1+RTCM3 <CR>
$R: sr2u, RTCM1+RTCM3
    RTCMv2Usage, RTCM1+RTCM3
COM1> sdcu, , , manual, 1011 <CR>
$R: sdcu, , , manual, 1011
    DiffCorrUsage, LowLatency, 3600.0, manual, 1011 ...
COM1>
    
```

3.2.17 RTCM v3.x Settings

sr3t	setRTCMv3CRSTransfo	Mode	TargetName (32)							
gr3t	getRTCMv3CRSTransfo	auto								
		manual								

[RxControl: Communication > Input Settings > Differential Corrections > RTCMv3](#)

Use this command to specify how to apply the coordinate reference system (CRS) transformation parameters contained in RTCM v3.x message types 1021 to 1023.

In `auto` mode (the default), the receiver decodes and applies the coordinate transformation parameters from message types 1021-1023. If your RTK provider sends transformation parameters for more than one target CRS, the receiver selects the first transformation parameters it receives.

In `manual` mode, you can force the receiver to only apply the transformation to the target CRS specified with the second argument. The `TargetName` argument must exactly match the name used by the RTK provider. The available target datum names can be found in the `RTCMDatum` SBF block.

Example

To force using the target CRS identified as "4258" by the RTK network, use:

```
COM1> sr3t, manual, "4258"<CR>
$R: sr3t, manual, "4258"
    RTCMv3CRSTransfo, manual, "4258"
COM1>
```

sr3d	setRTCMv3Delay	Delay								
gr3d	getRTCMv3Delay									
		0.0...600.0 s								

[RxControl: Communication](#) > [Output Settings](#) > [Differential Corrections](#) > [RTCMv3](#)

Use this command to instruct the receiver to generate and output RTCM v3.x messages with a certain delay.

It is possible to impose a global delay to all RTCM v3.x messages by setting the *Delay* to a non-zero value. This can be used in situations where multiple base stations must be configured to transmit their corrections in a time-multiplexed way. For example, base station A would compute and transmit its corrections at every 10-second epoch (in the GPS time scale), and base station B would compute and transmit its corrections 5 seconds after the 10-second epochs. In that case, receiver B would be configured with the *Delay* argument set to 5.

See also the **setRTCMv3Interval** command to configure the message interval.

Example

To generate the RTCM1001 message with an interval of 10 seconds and a time shift of 2 seconds, use:

```
COM1> sr3i, RTCM1001|2, 10 <CR>
$R: sr3i, RTCM1001|2, 10
    RTCMv3Interval, RTCM1001|2, 10
COM1> sr3d, 2 <CR>
$R: sr3d, 2
    RTCMv3Delay, 2
COM1>
```

sr3f gr3f	setRTCMv3Formatting getRTCMv3Formatting	ReferenceID	MSMSignals	GLOL2	RxType (32)					
		0...4095	+GPSL1CA +GPSL1PY +GPSL2PY +GPSL2C +GPSL5 +GLOL1CA +GLOL2P +GLOL2CA +GLOL3 +GALL1BC +GALE5a +GALE5b +GALE5 +GEOL1 +GEOL5 +BDSB1I +BDSB2I +BDSB3I +QZSL1CA +QZSL2C +QZSL5 +NAVICLS all	L2CA L2P	default					

[RxControl: Communication > Output Settings > Differential Corrections > RTCMv3](#)

Use these commands to configure the RTCM v3.x message contents when operating in base station mode.

The *ReferenceID* argument specifies the reference station ID transmitted in the header of each outgoing RTCM v3.x message.

The *MSMSignals* argument specifies the signal types to be encoded in MSM messages. For an observable to be actually encoded in MSM, the corresponding signal type must be enabled with this command, the signal must be enabled for tracking (see the **setSignalTracking** command), and a suitable MSM message must be enabled with the **setRTCMv3Output** command.

The *GLOL2* argument applies to message types 1011 and 1012 (GLONASS L1 and L2 observables). It specifies which of the L2P or the L2CA observables must be encoded in RTCM1011 and RTCM1012.

The *RxType* argument can be used to change the receiver type that is transmitted in message 1033, i.e. to change the way the receiver identifies itself to the RTCM network. Setting *RxType* to "default" reverts to the default receiver type.

Example

```
COM1> sr3f, 345 <CR>
$R: sr3f, 345
    RTCMv3Formatting, 345, GPSL1CA+GPSL2PY+GLOL1CA+GLOL2CA+GALL1BC+
    GALE5a+BDSB1I+BDSB2I+QZSL1CA+QZSL2C, L2CA, default
COM1>
```

sr3i gr3i	setRTCMv3Interval getRTCMv3Interval	Message Message	Interval							
		+ RTCM1001 2 + RTCM1003 4 + RTCM1005 6 + RTCM1007 8 + RTCM1009 10 + RTCM1011 12 + RTCM1013 + RTCM1019 + RTCM1020 + RTCM1029 + RTCM1033 + RTCM1042 + RTCM1044 + RTCM1045 + RTCM1046 + RTCM1230 + MSM1 ... MSM7 all	0.1 ... 1.0 ... 600.0 s							

[RxControl: Communication > Output Settings > Differential Corrections > RTCMv3](#)

Use these commands to define/inquire at which interval RTCM v3.x messages should be generated.

The intervals specified with this command are not connection-specific: all the connections which output a given RTCM v3.x message will output it with the same interval.

Using `MSMi` for the *Message* argument sets the interval of all Multiple Signal Messages of type *i*. Refer to appendix D for an overview of the supported RTCM v3.x messages.

For the ephemerides messages (e.g. RTCM1019), the ephemerides are sent out one satellite at a time, at a rate specified by this command. For instance, if *Interval* is set to 1 and there are 12 GPS ephemerides to send out, it takes 12 seconds to send the whole GPS ephemerides set.

By default, RTCM v3.x messages are generated at integer multiples of the specified interval in the GPS time scale. The command `setRTCMv3Delay` can be used to introduce a time offset.

Note that this command only defines the interval of RTCM messages. To make the receiver actually output these messages, use the `setRTCMv3Output` and `setDataInOut` commands.

Example

```
COM1> sr3i, RTCM1001|2, 2 <CR>
$R: sr3i, RTCM1001|2, 2
    RTCMv3Interval, RTCM1001|2, 2
COM1>
```

sr3m	setRTCMv3Message1029	<i>Message (120)</i>								
gr3m	getRTCMv3Message1029									
		<u>Unknown</u>								

[RxControl: Communication](#) > [Output Settings](#) > [Differential Corrections](#) > [RTCMv3](#)

Use these commands to define/inquire the string that will be transmitted in the RTCM v3.x message 1029. The argument *Message* can contain up to 120 characters.

Note that this command only defines the content of message 1029. To make the receiver actually output this message, use the **setRTCMv3Output** and **setDataInOut** commands.

Example

To send the string "Hello" in message 1029 over COM2 at the default interval, use the following sequence:

```
COM1> sr3m, Hello <CR>
$R: sr3m, Hello
    RTCMv3Message1029, "Hello"
COM1> sr3o, COM2, RTCM1029 <CR>
$R: sr3o, COM2, RTCM1029
    RTCMv3Output, COM2, RTCM1029
COM1> sdio, COM2, , RTCMv3 <CR>
$R: sdio, COM2, , RTCMv3
    DataInOut, COM2, auto, RTCMv3
COM1>
```

sr3o gr3o	setRTCMv3Output getRTCMv3Output	Cd Cd	Messages						
		+ COM1	none						
		+ COM2	+ RTCM1001						
		+ COM3	+ RTCM1002						
		+ COM4	+ RTCM1003						
		+ USB1	+ RTCM1004						
		+ USB2	+ RTCM1005						
		+ IP10 ... IP17	+ <u>RTCM1006</u>						
		+ NTR1	+ RTCM1007 ... RTCM1013						
		+ NTR2	+ RTCM1019						
		+ NTR3	+ RTCM1020						
		+ NTR4	+ RTCM1029						
		+ IPS1	+ RTCM1033						
		+ IPS2	+ RTCM1042						
		+ IPS3	+ RTCM1044						
		+ IPS4	+ RTCM1045						
		+ IPS5	+ RTCM1046						
		+ IPR1	+ RTCM1071						
		+ IPR2	+ RTCM1072						
		+ IPR3	+ RTCM1073						
		+ IPR4	+ <u>RTCM1074</u>						
		+ IPR5	+ RTCM1075						
		all	+ RTCM1076						
			+ RTCM1077						
			+ RTCM1081						
			+ RTCM1082						
			+ RTCM1083						
			+ <u>RTCM1084</u>						
			+ RTCM1085						
			+ RTCM1086						
			+ RTCM1087						
			+ RTCM1091						
			+ RTCM1092						
			+ RTCM1093						
			+ <u>RTCM1094</u>						
			+ RTCM1095						
			+ RTCM1096						
			+ RTCM1097						
			+ RTCM1101 ... RTCM1107						
			+ RTCM1111 ... RTCM1117						
			+ RTCM1121						
			+ RTCM1122						
			+ RTCM1123						
			+ <u>RTCM1124</u>						
			+ RTCM1125						
			+ RTCM1126						
			+ RTCM1127						
			+ RTCM1131 ... RTCM1137						
			+ <u>RTCM1230</u>						
			+ MSM1						
			+ MSM2						
			+ MSM3						
			+ MSM4						
			+ MSM5						
			+ MSM6						
			+ MSM7						
			all						

[RxControl: Communication > Output Settings > Differential Corrections > RTCMv3](#)

Use these commands to define/inquire which RTCM v3.x messages are enabled for output on a given connection descriptor (*Cd* - see 1.1.5). The *Messages* argument specifies the RTCM message types to be enabled.

A short description of the supported RTCM v3.x message types can be found in appendix D. `MSMi` enables the Multiple Signal Message - Type *i* from all constellations. Make sure to disable the legacy observation messages (MT1001-1004 and MT1009-1012) when enabling MSM messages as it is not advised to mix them.

Please make sure that the connection specified by *Cd* is configured to allow RTCMv3 output, which can be done with the `setDataInOut` command. The interval at which each message is output is to be specified with the `setRTCMv3Interval` command.

Example

To enable RTCM v3.x messages 1001, 1002, 1005 and 1006 on COM2, use the following sequence:

```
COM1> sr3o, COM2, RTCM1001+RTCM1002+RTCM1005+RTCM1006 <CR>
$R: sr3o, COM2, RTCM1001+RTCM1002+RTCM1005+RTCM1006
    RTCMv3Output, COM2, RTCM1001+RTCM1002+RTCM1005+RTCM1006
COM1> sdio, COM2, , RTCMv3 <CR>
$R: sdio, COM2, , RTCMv3
    DataInOut, COM2, auto, RTCMv3
COM1>
```

sr3u gr3u	setRTCMv3Usage getRTCMv3Usage	MsgUsage								
		none + RTCM1001 ... RTCM1013 + RTCM1015 + RTCM1016 + RTCM1017 + RTCM1019 ... RTCM1027 + RTCM1029 + RTCM1033 + RTCM1037 + RTCM1038 + RTCM1039 + RTCM1042 + RTCM1044 + RTCM1045 + RTCM1046 + RTCM1071 ... RTCM1077 + RTCM1081 ... RTCM1087 + RTCM1091 ... RTCM1097 + RTCM1121 ... RTCM1127 + RTCM1230 + MSM1 + MSM2 + MSM3 + MSM4 + MSM5 + MSM6 + MSM7 all								

RxControl: Communication > Input Settings > Differential Corrections > RTCMv3

Use this command to restrict the list of incoming RTCM v3.x messages that the receiver is allowed to use in its differential PVT computation.

A short description of the supported RTCM v3.x messages can be found in appendix D. *MSM_i* is an alias to enable the Multiple Signal Message - Type *i* from all constellations at once.

Example

To only accept RTCM1001 and RTCM1002 corrections from the base station 1011, use the following sequence:

```

COM1> sr3u, RTCM1001+RTCM1002 <CR>
$R: sr3u, RTCM1001+RTCM1002
    RTCMv3Usage, RTCM1001+RTCM1002
COM1> sdcu, , , manual, 1011 <CR>
$R: sdcu, , , manual, 1011
    DiffCorrUsage, LowLatency, 3600.0, manual, 1011 ...
COM1>
    
```

3.2.18 CMR v2.0 Settings

sc2f	setCMRv2Formatting	ReferenceID								
gc2f	getCMRv2Formatting									
		0...31								

RxControl: Communication > Output Settings > Differential Corrections > CMRv2

Use these commands to define/inquire the reference station ID assigned to the receiver when operating in base station mode. The reference station ID is transmitted in the header of each outgoing CMR v2.0 message.

Examples

```
COM1> sc2f, 12 <CR>
$R: sc2f, 12
    CMRv2Formatting, 12
COM1>
```

```
COM1> gc2f <CR>
$R: gc2f
    CMRv2Formatting, 12
COM1>
```

sc2i gc2i	setCMRv2Interval getCMRv2Interval	Message Message	Interval							
		+CMR0 +CMR1 +CMR2 +CMR3 all	0.1 ... 1.0 ... 600.0 s							

[RxControl: Communication > Output Settings > Differential Corrections > CMRv2](#)

Use these commands to define/inquire at which interval CMR v2.0 messages should be generated.

The intervals specified with this command are not connection-specific: all the connections which output a given CMR v2.0 message will output it with the same interval.

Note that this command only defines the interval of CMR messages. To make the receiver actually output these messages, use the **setCMRv2Output** and **setDataInOut** commands.

Refer to appendix D for an overview of the supported CMR v2.0 messages.

Examples

```
COM1> sc2i, CMR0, 2 <CR>
$R: sc2i, CMR0, 2
    CMRv2Interval, CMR0, 2
COM1>
```

```
COM1> gc2i <CR>
$R: gc2i CMRv2Interval, CMR0, 2
    CMRv2Interval, CMR1, 1 CMRv2Interval, CMR2, 1
COM1>
```

sc2m	setCMRv2Message2	<i>ShortID (8)</i>	<i>LongID (50)</i>	<i>COGO (16)</i>						
gc2m	getCMRv2Message2									
		<u>Unknown</u>	<u>Unknown</u>	<u>Unknown</u>						

[RxControl: Communication](#) > [Output Settings](#) > [Differential Corrections](#) > [CMRv2](#)

Use these commands to define/inquire the strings that will be transmitted in the CMR v2.0 message 2.

The argument *ShortID* is the short station ID. It can contain up to 8 characters in compliance with the CMR standard. If less than 8 characters are defined, the string will be right justified and padded with spaces.

The argument *LongID* is the long station ID. It can contain up to 50 characters in compliance with the CMR standard. If less than 50 characters are defined, the string will be right justified and padded with spaces.

The argument *COGO* is the COGO code. It can contain up to 16 characters in compliance with the CMR standard. If less than 16 characters are defined, the string will be right justified and padded with spaces.

Note that this command only defines the contents of message 2. To make the receiver actually output this message, use the **setCMRv2Output** and **setDataInOut** commands.

Example

To send the string "Hello" as short station ID and send CMR2 messages through COM2, use the following sequence:

```
COM1> sc2m, Hello <CR>
$R: sc2m, Hello
    CMRv2Message2, "Hello", "Unknown", "Unknown"
COM1> sc2o, COM2, CMR2 <CR>
$R: sc2o, COM2, CMR2
    CMRv2Output, COM2, CMR2
COM1> sdio, COM2, , CMRv2 <CR>
$R: sdio, COM2, , CMRv2
    DataInOut, COM2, auto, CMRv2
COM1>
```

sc2o gc2o	setCMRv2Output getCMRv2Output	Cd Cd	Messages						
		+ COM1 + COM2 + COM3 + COM4 + USB1 + USB2 + IP10 ... IP17 + NTR1 + NTR2 + NTR3 + NTR4 + IPS1 + IPS2 + IPS3 + IPS4 + IPS5 + IPR1 + IPR2 + IPR3 + IPR4 + IPR5 all	none + <u>CMR0</u> + <u>CMR1</u> + <u>CMR2</u> + <u>CMR3</u> all						

[RxControl: Communication > Output Settings > Differential Corrections > CMRv2](#)

Use these commands to define/inquire which CMR v2.0 messages are enabled for output on a given connection descriptor (*Cd* - see 1.1.5). The *Messages* argument specifies the CMR message types to be enabled. Refer to appendix D for an overview of the supported CMR v2.0 messages.

Please make sure that the connection specified by *Cd* is configured to allow CMRv2 output, which can be done with the **setDataInOut** command. The interval at which each message is output is to be specified with the **setCMRv2Interval** command.

Example

To enable CMR v2.0 message 0 on COM2, use the following sequence:

```
COM1> sc2o, COM2, CMR0 <CR>
$R: sc2o, COM2, CMR0
    CMRv2Output, COM2, CMR0
COM1> sdio, COM2, , CMRv2 <CR>
$R: sdio, COM2, , CMRv2
    DataInOut, COM2, auto, CMRv2
COM1>
```

sc2u gc2u	setCMRv2Usage getCMRv2Usage	MsgUsage								
		none + <u>CMR0</u> + <u>CMR1</u> + <u>CMR2</u> + <u>CMR3</u> + <u>CMR0p</u> + <u>CMR0w</u> all								

RxControl: Communication > Input Settings > Differential Corrections > CMRv2

Use this command to restrict the list of incoming CMR v2.0 messages that the receiver is allowed to use in its differential PVT computation. `CMR0p` and `CMR0w` refer to the CMR+ and CMR-W variants respectively.

A short description of the supported CMR v2.0 messages can be found in appendix D.

Example

To only accept CMR0 from the base station 12, use the following sequence:

```

COM1> sc2u, CMR0 <CR>
$R: sc2u, CMR0
    CMRv2Usage, CMR0
COM1> sdcu, , , manual, 12 <CR>
$R: sdcu, , , manual, 12
    DiffCorrUsage, LowLatency, 3600.0, manual, 12 ...
COM1>
    
```

3.2.19 Internal Disk Logging

sdfa	setDiskFullAction	Disk	Action						
gdfa	getDiskFullAction	Disk	Action						
		+DSK1 all	DeleteOldest StopLogging						

[RxControl: Logging > Internal Logging Settings > Global Logging Options](#)

Use these commands to define/inquire what the receiver should do when the disk identified by *Disk* is full.

The currently supported actions are as follows:

Action	Description
DeleteOldest	The oldest file on the disk is automatically removed, unless the oldest file is also the current logging file. In that latter case, the logging stops. In incremental file naming mode, if the auto-incremented file name already exists, the existing file is overwritten.
StopLogging	All logging activity stops on the specified disk.

Examples

```
COM1> sdfa, DSK1, StopLogging <CR>
$R: sdfa, DSK1, StopLogging
    DiskFullAction, DSK1, StopLogging
COM1>
```

```
COM1> gdfa <CR>
$R: gdfa
    DiskFullAction, DSK1, StopLogging
COM1>
```

ldi	IstDiskInfo	Disk	Directory (60)							
		DSK1 all								

Use this command to retrieve information about the disk identified by the *Disk* argument. The reply to this command contains the disk size and free space in bytes and the list of all recorded files and directories.

The content of directories is not shown by default. To list the content of a directory, use the second argument to specify the directory name.

Example

```
COM1> ldi, DSK1 <CR>
$R; ldi, dsk1
---->
$-- BLOCK 1 / 0
<?xml version="1.0" encoding="ISO-8859-1" ?>
<DiskInfo version="0.1">
  <Disk name="DSK1" total="2030927872" free="2030764032" >
    <File name="log.sbf" size="16384" />
    <File name="leuv2050.07_" size="35196" />
  </Disk>
</DiskInfo>
COM1>
```

sfn gfn	setFileNaming getFileNaming	Cd Cd	NamingType	FileName (20)						
		+ DSK1 all	FileName Incremental IGS15M IGS1H IGS6H IGS24H	log						

[RxControl: Logging > Internal Logging Settings > SBF Logging and Upload](#)

Use these commands to define/inquire the file naming convention for the internal SBF, NMEA or user-message log files.

If *NamingType* is `FileName`, the file name is given by the third argument *FileName*, followed by the extension `.sbf`, `.nma` or `.ecm` for SBF, NMEA and user-message files respectively. User-message files contain messages entered by the command **exeEchoMessage** prefixed with the GPS week number and time of week in seconds.

If *NamingType* is `Incremental`, the file name is given by the first five characters of the *FileName* argument (right padded with "_" if necessary), followed by a modulo-1000 counter incrementing each time logging is stopped and restarted. The file name extension is `.sbf`, `.nma` or `.ecm` as described above. If the auto-incremented file name already exists on the disk, the receiver takes action as specified by the **setDiskFullAction** command.

The set of allowed characters for the *FileName* argument is:

`_0123456789ABCDEFGHIJKLMNPOQRSTUVWXYZabcdefghijklmnopqrstuvwxyz`

If *NamingType* is `IGS15M`, `IGS1H`, `IGS6H` or `IGS24H`, the receiver automatically creates a new file every 15 minutes, every hour, every 6 hours or every 24 hours respectively, and the file name adheres to the IGS/RINEX2.11 naming convention.

The 4-character station identifier is the first four letters of the station code as set by the **setMarkerParameters** command. If the station code is empty, the first four letters of the marker name are used.

If desired, it is also possible to add a log session ID prefix to all file names logged in IGS naming mode. This is enabled with the **setGlobalFileNamingOptions** command.

In IGS naming mode, the files are put in daily directories, the directory name being of the form `yyddd` with `yy` the 2-digit year and `ddd` the day of year. If *NamingType* is `FileName` or `Incremental`, the file is put in the root directory.

Note that the actual file name on the disk is case insensitive and only contains lower-case characters even if the user entered upper-case characters in the *FileName* argument.

If the naming convention is changed while logging is ongoing, the current file is closed and the logging continues in a new file with the name as specified.

Example

To have a fixed file name "mytest.sbf", use:

```
COM1> sfn, DSK1, FileName, mytest <CR>
$R: sfn, DSK1, FileName, mytest
```

```
FileNaming, DSK1, FileName, "mytest"  
COM1>
```

sfno	setGlobalFileNamingOptions	<i>BusyTag</i>								
gfno	getGlobalFileNamingOptions									
		off								
		on								

RxControl: Logging > Internal Logging Settings > Global Logging Options

By default, files names follow the convention described with the logging commands (**setFileNaming**, **setRINEXLogging**).

By setting the *BusyTag* argument to `on`, a ".A" suffix is added to all files that are currently written to for easy identification. The suffix is removed when the file is closed.

Example

```
COM1> sfno, on<CR>
$R: sfno, on
  GlobalFileNamingOptions, on
COM1>
```

emd gmd	exeManageDisk getManageDisk	Disk	Action							
		DSK1	Unmount Mount Format							

RxControl: Logging > Disk(s) > Disk Management

Use this command to manage the disk identified by the *Disk* argument.

Specify the action `Format` to format the disk (all data will be lost).

The `Mount` and `Unmount` actions mount and unmount the disk respectively. Unmounting an internal disk makes it available as a mass-storage device when the USB cable is connected to a PC, i.e. it makes the disk appear as a drive on most file browsers. When the disk is mounted, it cannot be accessed as a mass-storage device. Internal logging is only possible when the disk is mounted. See the `setUMSDOnConnect` command to automatically unmount the disk upon connecting the USB cable.

Prior to formatting or unmounting the disk, make sure to stop all disk activities. If the specified action could not be performed, an error message is returned.

Example

To format the first disk (DSK1), use:

```
COM1> emd, DSK1, Format <CR>
      $R: emd, DSK1, Format
      ManageDisk, DSK1, Format
COM1>
```

lrf	lstRecordedFile	Disk	FileName (60)							
		DSK1								

Use this command to retrieve the contents of one of the log files on the disk identified with the *Disk* argument.

The reply to this command consists in a succession of blocks starting with the "\$-- BLOCK" header, and terminating with the pseudo-prompt "---->" (see section Section 3.1.3, "Command Replies" for details). The decoding program must remove these headers and pseudo-prompts to recover the original file contents.

The download speed is highly influenced by the processor load. To speed up the download, it is recommended to stop the signal tracking, which can be done by typing the following command before starting the download: **setSatelliteTracking, none**.

The file download can be interrupted by sending ten uppercase "S" characters (simply by holding the "shift-S" key pressed) to the connection through which the download is taking place.

Examples

To output the contents of the internal log file named `log.sbf` on the first disk (DSK1), use:

```
COM1> lrf, DSK1, log.sbf <CR>
$R; lrf, DSK1, log.sbf
... Here comes the content of log.sbf ...
COM1>
```

If the file `log.sbf` does not exist, an error is returned:

```
COM1> lrf, DSK1, log.sbf <CR>
$R? lstRecordedFile: Argument 'FileName' could not be handled!
COM1>
```

erf grf	exeRemoveFile getRemoveFile	Disk	FileName (200)							
		DSK1	none all							

RxControl: Logging > Remove Internal File

Use this command to remove one file or an entire directory from the disk identified by the *Disk* argument.

If *FileName* is the name of a file, only that single file is removed from the disk. Files in a directory can be specified using *dirname/filename*.

If *FileName* is the name of a directory, the entire directory is deleted, except the file currently written to, if any.

If the reserved string *all* is used for the *FileName* argument, all files are removed from the selected disk, except the file currently written to, if any.

If there is no file nor directory named *FileName* on the disk or if the file is currently written to, an error message is returned.

Examples

To remove the file "ATRX2980.03_" from directory "03298", use:

```
COM1> erf, DSK1, 03298/ATRX2980.03_ <CR>
$R: erf, DSK1, 03298/ATRX2980.03_
    RemoveFile, DSK1, "03298/ATRX2980.03_"
COM1>
```

To remove all files from DSK1, use:

```
COM1> erf, DSK1, all <CR>
$R: erf, DSK1, all
    RemoveFile, DSK1, all
COM1>
```

srxi grxl	setRINEXLogging getRINEXLogging	Cd Cd	FileDuration	ObsInterval	SignalTypes	ExtraObsTypes	RINEXVersion	MixedNav		
		+ DSK1 all	none hour1 hour6 hour24 minute15	sec1 sec2 sec5 sec10 sec15 sec30 sec60	none + GPSL1CA + GPSL1PY + GPSL2PY + GPSL2C + GPSL5 + GLOL1CA + GLOL2P + GLOL2CA + GLOL3 + GALL1BC + GALE5a + GALE5b + GALE5 + GEOL1 + GEOL5 + BDSB1I + BDSB2I + BDSB3I + BDSB1C + BDSB2a + QZSL1CA + QZSL2C + QZSL5 + NAVICL5 all	none + Dx + Sx + Channel all	v2x v3x	off on		

[RxControl: Logging > Internal RINEX Logging > RINEX Logging Options](#)

Use this command to configure RINEX file logging on the disk identified with the *Cd* argument.

The argument *FileDuration* specifies whether a new RINEX file should be started every 15 minutes, every hour, 6 hours or every day. When *FileDuration* is set to `none`, RINEX logging is disabled and all following arguments are ignored.

ObsInterval specifies the interval of the observation records.

SignalTypes sets the list of signals to encode in the RINEX observation files. The more signals are selected, the bigger the RINEX files.

By default, the RINEX files contain the code and carrier phase observables. The *ExtraObsTypes* argument allows to also include the Doppler (obs code Dx), the C/N₀ (obs code Sx), or the channel number (obs code X).

The argument *RinexVersion* selects which RINEX version to use.

The argument *MixedNav* specifies whether the navigation data is stored in separate files for each constellation (*MixedNav* set to `off`), or in a single mixed file (*MixedNav* set to `on`). This argument is ignored if *RINEXVersion* is `v2x`. Note that QZSS and BeiDou navigation data are only available in the mixed navigation file.

In the RINEX file names, the 4-character station identifier is the first four letters of the station code as set by the **setMarkerParameters** command. If the station code is empty, the first four letters of the marker name are used instead.

If desired, it is also possible to add a log session ID prefix to all RINEX file names. This is enabled with the **setGlobalFileNamingOptions** command.

RINEX files are put in daily directories, the directory name being of the form `yyddd` with `yy` the 2-digit year and `ddd` the day of year.

If a RINEX file is currently being logged when issuing this command, the new settings will only be applied when the next RINEX file will be started. This occurs at a rate specified by *FileDuration*. To force the new settings to be immediately applied, RINEX logging must be temporarily stopped (*FileDuration* set to `none`) and then re-enabled. Changing the RINEX settings (e.g. changing the list of signals to be stored in RINEX) results in the past data to be overwritten in the RINEX file.

Example

To create daily RINEX files with the observation file containing only GPS L1CA data at a 30-s interval, use:

```
COM1> srxl, DSK1, hour24, sec30, GPSL1CA <CR>
$R: srxl, DSK1, hour24, sec30, GPSL1CA
  RINEXLogging, DSK1, hour24, sec30, GPSL1CA, none, v2x, on
COM1>
```

suoc	setUMSDOnConnect	Mode								
guoc	getUMSDOnConnect									
		off								
		on								

RxControl: Logging > Disk(s) > Disk Access over USB

Use this command to enable or disable automatic activation of the USB mass-storage device (UMSD) upon connecting the USB port to a computer.

When the receiver is attached to your computer through an USB cable, the internal disk (DSK1) can be accessed using a standard file browser, where it appears as a removable drive or USB mass-storage device. This requires the disk to be unmounted by the receiver so that it can be accessed by your computer's operating system. Unmounting the disk can be done manually with the **exeManageDisk** command, or can be done automatically by the receiver each time the USB cable is attached to your computer.

When the *Mode* argument is `on`, each time the USB cable is connected, the receiver stops logging data and unmounts the internal disk. The disk becomes visible in your file browser. When the USB cable is disconnected, the internal disk is automatically remounted and logging resumes.

When *Mode* is `off`, activation of the USB mass-storage device is not done automatically and requires manually unmounting the internal disk with the **exeManageDisk** command.

Example

```
COM1> suoc, off<CR>
$R: suoc, off
    UMSDOnConnect, off
COM1>
```

3.2.20 FTP Push of Log Files

sfpr	setFTPPushRINEX	Server (32)	Path (64)	User (12)	Password (24)				
gfpr	getFTPPushRINEX			anonymous					

[RxControl: Logging > Internal RINEX Logging > RINEX FTP Push Options](#)

Use this command to automatically send the onboard RINEX files to a remote FTP server (FTP Push). The arguments specify the FTP server hostname or IP address, the path to the remote directory where to put the RINEX files, and the login and password to use. Note that the receiver encrypts the password so that it cannot be read back with the command **getFTPPushRINEX**.

The RINEX files are FTPed when they are complete, as prescribed by the *FileDuration* settings in the **setRINEXLogging** command. The current files are also FTPed when the user disables RINEX logging.

The files are put in the remote directory specified in the *Path* argument. Special character sequences can be used to encode the file date in the path: %y is replaced with the 2-digit year, %Y with the 4-digit year, %m with the month, %d with the day of the month, and %j with the day of the year (starting with 001). To put a literal "%" in the path, use %%. After expansion, *Path* must not be longer than 80 characters.

If the directory specified in the *Path* argument does not exist on the remote server, it is created.

If the transfer or the directory creation fails, an error is flagged (enter the command **lstInternalFile**, **Error** to see the errors and clear the error flag).

Example

```
COM1> sfpr, ftp.mydomain.com, mydata/%Y%m%d, myname, mypwd <CR>
$R: sfpr, ftp.mydomain.com, mydata/%Y%m%d, myname, mypwd
    FTTPushRINEX, "ftp.mydomain.com", "mydata/%Y%m%d",
    "myname", "7UU5CL7W1C75DWXX2TEXD3W"
COM1>
```

sfps	setFTPPushSBF	Server (32)	Path (64)	User (12)	Password (24)					
gfps	getFTPPushSBF			anonymous						

RxControl: Logging > Internal Logging Settings > SBF Logging and Upload

Use this command to automatically send the onboard SBF files to a remote FTP server (FTP push). The arguments specify the FTP server hostname or IP address, the path to the remote directory where to put the SBF files, and the login and password to use. Note that the receiver encrypts the password so that it cannot be read back with the command **getFTPPushSBF**.

FTP push is only available in IGS file naming mode (see the **setFileNaming** command). Each time an SBF file is ready, it is FTPed to the specified server. For example, in `IGS1H` file naming mode, files are FTPed every hour. The current log file is also FTPed when the user disables internal logging.

The files are put in the remote directory specified in the *Path* argument. Special character sequences can be used to encode the file date in the path: `%y` is replaced with the 2-digit year, `%Y` with the 4-digit year, `%m` with the month, `%d` with the day of the month, and `%j` with the day of the year (starting with 001). To put a literal "%" in the path, use `%%`. After expansion, *Path* must not be longer than 80 characters.

If the directory specified in the *Path* argument does not exist on the remote server, it is created.

If the transfer or the directory creation fails, an error is flagged (enter the command **lstInternalFile**, **Error** to see the errors and clear the error flag).

Example

```
COM1> sfps, ftp.mydomain.com, mydata/%Y%m%d, myname, mypwd <CR>
$R: sfps, ftp.mydomain.com, mydata/%Y%m%d, myname, mypwd
    FTPPushSBF, "ftp.mydomain.com", "mydata/%Y%m%d",
    "myname", "7UU5CL7W1C75DWXX2TEXD3W"
COM1>
```

efpt	exeFTPPushTest	Server (40)	Path (64)	User (20)	Password (40)					
gfpt	getFTPPushTest			anonymous						

RxControl: Logging > Test FTP Push to Server

Use this command to test write access to a FTP server.

The arguments specify the FTP server hostname or IP address, the path to the remote directory where write access will be tested, and the login and password to use. The *Path* may contain variable fields as explained in the **setSBFFTP** command.

Upon receiving this command, the receiver tries to connect to the specified FTP server and to write a short file in the directory specified with the *Path* argument. The file is then deleted from the FTP server.

The process can take several minutes depending on the network latency. At the end, a report message is posted in the activity log. This message can be retrieved with the **lstInternalFile**, **RxMessages**, and is also available in the `RxMessage` SBF block.

Example

```
COM1> efpt, myftp.com, mydata/%Y%m%d, myname, mypwd<CR>
$R: efpt, myftp.com, mydata/%Y%m%d, myname, mypwd
  FTTPushTest, myftp.com, mydata/%Y%m%d, myname, mypwd
COM1>
```

3.2.21 MSS/L-Band Configuration

slbb glbb	setLBandBeams getLBandBeams	Beam Beam	Frequency	Rate	Name (8)	Region (8)	Usage			
		+ User1 + User2 all	1525000000 ... 1559000000 Hz	baud600 baud1200 baud2400 baud4800	Unknown	Unknown	Disabled Enabled			

RxControl: L-band > Generic L-Band Settings > Satellite Beam Configuration

This command can be used to define/inquire the parameters of user-defined L-Band beams. A beam is characterized by its frequency and baud rate (the *Frequency* and *Rate* arguments). Optionally, a beam name and region ID can also be associated to each beam, for information only. A beam can be enabled or disabled, as set by the *Usage* argument. Only enabled beams can be locked to.

Example

```
COM1> slbb, User1, 1537460000, baud1200, 25East, E, Enabled <CR>
$R: slbb, User1, 1537460000, baud1200, 25East, E, Enabled
    LBandBeams, User1, 1537460000, baud1200, "25East", "E", Enabled
COM1>
```

slcs	setLBandCustomServiceID	ServiceID (4)	ScramblingVector	NDAUsage						
glcs	getLBandCustomServiceID									
		0000	0000	off on						

RxControl: L-band > Generic L-Band Settings > Satellite Beam Configuration

This command can be used to define the Service ID, scrambling vector and Null-Data-Algorithm (NDA) usage of the L-Band service provider. The *ServiceID* and *ScramblingVector* are 4-digit hexadecimal numbers.

This command should only be used for test and maintenance purposes.

Example

```
COM1> slcs, A5A5, 0101, on<CR>
$R: slcs, A5A5, 0101, on
    LBandCustomServiceID, A5A5, 0101, on
COM1>
```

sism	setLBandSelectMode	Mode	Service	Beam1	Beam2					
gism	getLBandSelectMode									
		auto off manual	Inmarsat Sapcorda	User1 User2 Sapcorda 1 Sapcorda 2	User1 User2 Sapcorda 1 Sapcorda 2					

RxControl: L-band > Generic L-Band Settings > Satellite Beam Configuration

This command can be used to define/inquire the main operation mode of the L-Band demodulator.

The following modes are available through the *Mode* argument:

Mode	Description
auto	The demodulator will try to lock to a visible beam, preferring beams to which access has been granted. The list of beams and their status can be retrieved by the command 1stLBandBeams .
off	The demodulator will be disabled and will not attempt to lock to any beam.
manual	The demodulator will attempt to lock to the beams identified in the <i>Beam1</i> arguments and ignore all other beams. The parameters of the beams (frequency and baud rate) can be retrieved by the command 1stLBandBeams . Make sure that the beams identified in the <i>Beam1</i> arguments are enabled (see command setLBandBeams).

The second argument *Service* specifies which service the demodulator has to lock to.

Example

```
COM1> sism, manual, Sapcorda, User1, User2<CR>
$R: sism, manual, Sapcorda, User1, User2
    LBandSelectMode, manual, Sapcorda, User1, User2
COM1>
```

3.2.22 PinPoint-GIS RX Configuration

eccd	exeClearCollectDatabase	CollectDB								
gccd	getClearCollectDatabase									
		+ CollectDB1 + CollectDB2 + CollectDB3 all								

RxControl: Gis > Database > Clear

Use this command to clear the contents of a collection database. The *CollectDB* argument defines which database(s) will be cleared.

Example

```
COM1> eccd, CollectDB2<CR>
$R: eccd, CollectDB2
    ClearCollectDatabase, CollectDB2
COM1>
```

scdd gcdd	setCollectDBAppData getCollectDBAppData	CollectDB CollectDB	AppParams1 (255)	AppParams2 (255)	AppParams3 (255)	AppParams4 (255)				
		+ CollectDB1 + CollectDB2 + CollectDB3 all								

RxControl: Gis > Settings > Global Settings

This command is Septentrio proprietary and is not documented here.

Example

```
COM1> scdd, CollectDB1, "", "", "", ""<CR>
$R: scdd, CollectDB1, "", "", "", ""
    CollectDBAppData, CollectDB1, "", "", "", ""
COM1>
```

scdt gcdt	setCollectDBAttributes getCollectDBAttributes	Attribute Attribute	CollectDB	Name (40)	Value (40)					
		+ Attr1 ... Attr20 all	none + CollectDB1 + CollectDB2 + CollectDB3							

[RxControl: Gis > Settings > Global Settings](#)

Use this command to define the attributes that can be associated to points collected with the **exeCollectPoint** command. Up to 20 attributes can be defined.

The *CollectDB* argument specifies which collection database should include the attribute identified by the *Attribute* argument. Use `none` to disable an attribute from all databases.

The *Name* argument is a user-defined name given to the attribute, and the *Value* argument defines the value assigned to the attribute. There are two types of attributes: receiver-defined attributes of which the value is set by the receiver (for example the latitude of a collected point), and user-defined attributes of which the value is set by the user (for example a name given by the user when collecting a point).

To define a receiver-defined attribute, the *Value* argument must be a valid placeholder (see **lstCollectPlaceholders** for a list of valid placeholders), e.g. `*PVTGeodetic_Latitude*`. If the *Value* argument is not a valid placeholder, the attribute is user-defined. In that case, the string provided in the *Value* argument is the default value of the attribute. When collecting a point, the *Comment* argument of the **exeCollectPoint** or the **exeUpdatePoint** command can be used to assign a different value to an attribute than the default value. For example, if the *Name* argument is set to `color` and the *Value* argument is set to `black`, the default color assigned to the collected points will be black. To collect a point to the first database with the color set to "red", invoke the **exeCollectPoint**, `CollectDB1`, `"*color*==red*"` command.

Examples

To define an attribute called "CartX" containing the ECEF X coordinate of a point, use:

```
COM1> scdt, Attr1, CollectDB1, "CartX", "*PVTCartesian_X*"<CR>
$R: scdt, Attr1, CollectDB1, "CartX", "*PVTCartesian.X*"
    CollectDBAttributes, Attr1, CollectDB1, "CartX", "*PVTCartesian_X
    *"
COM1>
```

To define an attribute called "color" with default value "black" use:

```
COM1> scdt, Attr1, CollectDB1, "color", "black"<CR>
$R: scdt, Attr1, CollectDB1, "color", "black"
    CollectDBAttributes, Attr1, CollectDB1, "color", "black"
COM1>
```

scdo	setCollectDBProperties	CollectDB	Name (50)							
gcdo	getCollectDBProperties	CollectDB								
		+ CollectDB1 + CollectDB2 + CollectDB3 all								

RxControl: Gis > Settings > Global Settings

Use this command to assign a user-defined name to the collection databases.

Example

```
COM1> scdo, CollectDB1, Survey Test<CR>
$R: scdo, CollectDB1, Survey Test
    CollectDBProperties, CollectDB1, Survey Test
COM1>
```

lci	lstCollectedItems	Item	Attributes (255)							
		CollectDB1 CollectDB2 CollectDB3 all [collectId]	"+"-separated list of attributes							

Use this command with the argument *Item* set to `CollectDB1`, `CollectDB2`, `CollectDB3` or `all` to list the `SSN_ID` and selected attributes of all the items collected in the database in question. The `SSN_ID` is a receiver unique ID assigned to each collected item.

Use this command with the argument *Item* set to a specific `SSN_ID` to retrieve the details of that particular collected item.

The *Attributes* argument specifies which attributes to show. The available attributes are those returned by the `lstCollectPlaceholders` command (without the "*" characters) and those defined with the `setCollectDBAttributes` command. In that latter case, attributes must be identified by their name as defined by the *Name* argument of `setCollectDBAttributes`. The different attributes must be separated by "+" signs.

Examples

```
COM1> lci, CollectDB1, PVTGeodetic_Latitude+PVTGeodetic_Longitude
<CR>
$R; lci, CollectDB1
---->
$-- BLOCK 1 / 0 C
<?xml version="1.0" encoding="ISO-8859-1" ?>
<CollectedItems version="1">
---->
$-- BLOCK 2 / 0 C
<CollectDataBase name="CollectDB1" items="1" a0=
    "PVTGeodetic_Latitude" a1="PVTGeodetic_Longitude" >
<item SSN_ID="1035285715000" a0="0.546845612" a1="0.054687552" />
</CollectDataBase>
</CollectedItems>
COM1>
```

```
COM1> lci, 1035285715000,
    TOW+WNC+PVTGeodetic_Latitude+PVTGeodetic_Longitude+Comment <CR>
$R; lci, 1035285715000
---->
$-- BLOCK 1 / 0 C
<?xml version="1.0" encoding="ISO-8859-1" ?>
<CollectedItems version="1" a1="TOW" a2="WNC" a3=
    "PVTGeodetic_Latitude" a4="PVTGeodetic_Longitude" a5="Comment" >
---->
$-- BLOCK 2 / 0 C
<item SSN_ID="1035285715000" a0="472915000" a1="1711" a2=
    "0.924186200972626" a3="-0.0206571898026415" a4="test" />
</CollectedItems>
COM1>
```

lcp	lstCollectPlaceholders									
-----	------------------------	--	--	--	--	--	--	--	--	--

Use this command to get a list of all the predefined placeholders that can be used with **setCollectDBAttributes**.

Most of the placeholders correspond to a field from an SBF block: e.g. `*PVTCartesian_X*` corresponds to the X field from the `PVTCartesian` SBF block. In addition, the following placeholders are available:

- `*SSN_ID*`: a receiver unique ID for each of the collected points (representing the GNSS time in milliseconds)
- `*Comment*`: the comment string as entered by the **exeCollectPoint** or the **exeUpdatePoint** command

Example

```
COM1> lcp <CR>
$R; lstCollectPlaceholders
---->
$-- BLOCK 1 / 0
<?xml version="1.0" encoding="ISO-8859-1" ?>
<CollectPlaceholders version="1">
  <CollectPlaceholder name="*SSN_ID*" />
  <CollectPlaceholder name="*PVTGeodetic_Latitude*" />
  <CollectPlaceholder name="*PVTGeodetic_Longitude*" />
  <CollectPlaceholder name="*PVTGeodetic_Height*" />
  <CollectPlaceholder name="*PVTCartesian_X*" />
  <CollectPlaceholder name="*PVTCartesian_Y*" />
  <CollectPlaceholder name="*PVTCartesian_Z*" />
  <CollectPlaceholder name="*PVTCartesian_Undulation*" />
  <CollectPlaceholder name="*PVTCartesian_Datum*" />
  <CollectPlaceholder name="*TOW*" />
  <CollectPlaceholder name="*WNC*" />
  <CollectPlaceholder name="*Comment*" />
  <CollectPlaceholder name="*ReceiverSetup_RxSerialNumber*" />
</CollectPlaceholders/>
COM1>
```

ecp gcp	exeCollectPoint getCollectPoint	CollectDB	Comment (250)							
		CollectDB1 CollectDB2 CollectDB3								

RxControl: Gis > Collect > Collect Point

Use this command to collect a point to a database. The *CollectDB* argument defines to which database the point will be added. The receiver assigns a unique ID to each collected point (SSN_ID).

The *Comment* argument can be used to specify the value of the user-defined attributes defined with the **setCollectDBAttributes** command.

Example

If a "tree" and an "age" attribute have been defined with the **setCollectDBAttributes** command, use the following command to add a 30 year old oak tree to the first data base:

```
COM1> ecp,CollectDB1,"*tree**oak**age**30*"<CR>
$R: ecp,CollectDB1,"*tree**oak**age**30*"
    CollectPoint, CollectDB1, "*tree**oak**age**30*"
COM1>
```

edp gdp	exeDeletePoint getDeletePoint	CollectID								
		0 ...4398046511104								

RxControl: Gis > Collect > Delete Point

Use this command to delete a point from a database. *CollectID* is the SSN_ID of the point that will be deleted. Use the **1stCollectedItems** command for a list of all SSN_IDs.

Example

```
COM1> edp, 6377833<CR>
$R: edp, 6377833
    DeletePoint, 6377833
COM1>
```

eup gup	exeUpdatePoint getUpdatePoint	CollectID	Comment (250)							
		0 ...4398046511104								

RxControl: Gis > Collect > Update Point

Use this command to update a collected point. *CollectID* is the SSN_ID of the point that will be updated. Use the **lstCollectedItems** command for a list of all SSN_IDs.

Updating a point means that the point coordinates and associated information will be replaced by their current values, and that the user-defined attributes will be updated according to the *Comment* argument. If the *Comment* argument is empty, the user-defined attributes are reverted to their default value as set with the **setCollectDBAttributes** command.

Example

```
COM1> eup, 51248, *tree*=oak<CR>
$R: eup, 51248, *tree*=oak*
    UpdatePoint, 51248, *tree*=oak*
COM1>
```

ewcf gwcf	exeWriteCollectCsvFile getWriteCollectCsvFile	CollectDB	Disk	FileName (8)	Separator					
		CollectDB1 CollectDB2 CollectDB3	DSK1	collect	Comma Tab Colon SemiColon Space Vertical_Bar					

RxControl: Gis > Database > Write CSV File

Use this command to write the contents of a database to an ASCII file. *CollectDB* defines which database will be written. The *CD* argument specifies the disk on which the file will be written and the *FileName* specifies the name of the file. The receiver adds the extension `.CSV` to the filename. The file is written in the top directory of the specified disk.

The *Separator* specifies the delimiter used in the file between the different columns.

The first line of the file is the header. It contains a list of all attributes defined in the database, identified by their name as defined by the *Name* argument of `setCollectDBAttributes`. After the header, the file contains a line for each collected point. An example of file is as follows:

```
MyName,TimeOfWeek,Height
MyPoint1,139751.000,129.030632281676
MyPoint2,139761.000,148.232541111112
```

Example

```
COM1> ewcf, CollectDB1, DSK1, collect, Comma<CR>
$R: ewcf, CollectDB1, DSK1, collect, Comma
    WriteCollectCsvFile, CollectDB1, DSK1, collect, Comma
COM1>
```

3.2.23 Cosmos Configuration

scoc	setCosmosConfig	<i>Enable</i>	<i>CustomerID (24)</i>							
gcoc	getCosmosConfig									
		off on								

RxControl: Communication > Cosmos



Cosmos support is a beta feature and the command description below is subject to change.

Cosmos is a tool that makes it possible to visualize the health and status information of multiple GNSS receivers in a single dashboard, as well as to functionally manage these receivers.

To include the receiver in the Cosmos tool, among others the Cosmos service must be installed on the receiver, and this service must be correctly configured.

Use this command to configure the Cosmos service on the receiver.

The *Enable* argument determines whether or not the Cosmos service is executed on the receiver. The *CustomerID* argument is used to identify the customer in whose Cosmos dashboard the receiver must be included. This value is unique per customer and must be obtained from Septentrio.

Besides the configuration in this command, Cosmos certificate and key files must be uploaded to the receiver. These files must also be obtained from Septentrio and can be uploaded using the web interface (using the "Communication > Cosmos" page).

Please refer to the Cosmos documentation and/or to Septentrio sales/support for more information on deploying Cosmos.

Example

```
COM1> scoc, on, customerx<CR>
$R: scoc, on, customerx
    CosmosConfig, on, customerx
COM1>
```

Chapter 4

SBF Reference

4.1 SBF Outline

SBF is the binary output format of Septentrio receivers. In this format, the data are arranged in binary blocks referred to as SBF blocks.

Each SBF block consists of a sequence of numeric or alphanumeric fields of different types and sizes. The total block size is always a multiple of 4 bytes.

The fields of an SBF block may have one of the following types:

Type	Description
u1	Unsigned integer on 1 byte (8 bits)
u2	Unsigned integer on 2 bytes (16 bits)
u4	Unsigned integer on 4 bytes (32 bits)
i1	Signed integer on 1 byte (8 bits)
i2	Signed integer on 2 bytes (16 bits)
i4	Signed integer on 4 bytes (32 bits)
f4	IEEE float on 4 bytes (32 bits)
f8	IEEE float on 8 bytes (64 bits)
c1[X]	String of X ASCII characters, right padded with bytes set to 0 if needed.

Each multi-byte binary type is transmitted as little-endian, meaning that the least significant byte is the first one to be transmitted by the receiver. Signed integers are coded as two's complement.

Every SBF block begins with an 8-byte block header, which is followed by the block body.

4.1.1 SBF Block Header Format

Every SBF block starts with an 8-byte header having the following contents:

Parameter	Type	Description
Sync	c1[2]	The Sync field is a 2-byte array always set to 0x24, 0x40. The first byte of every SBF block has hexadecimal value 24 (decimal 36, ASCII '\$'). The second byte of every SBF block has hexadecimal value 40 (decimal 64, ASCII '@'). These two bytes identify the beginning of any SBF block and can be used for synchronization.
CRC	u2	The CRC field is the 16-bit CRC of all the bytes in an SBF block from and including the ID field to the last byte of the block. The generator polynomial for this CRC is the so-called CRC-CCITT polynomial: $x^{16} + x^{12} + x^5 + x^0$. The CRC is computed in the forward direction using a seed of 0, no reverse and no final XOR.
ID	u2	The ID field is a 2-byte block ID, which uniquely identifies the block type and its contents. It is a bit field with the following definition: bits 0-12: block number; bits 13-15: block revision number, starting from 0 at the initial block definition, and incrementing each time backwards-compatible changes are performed to the block (see section 4.1.6).
Length	u2	The Length field is a 2-byte unsigned integer containing the size of the SBF block. It is the total number of bytes in the SBF block including the header. It is always a multiple of 4.

4.1.2 SBF Block Names and Numbers

The structure and contents of an SBF block are unambiguously identified by the block ID. For easier readability, a block name is also defined for each block. When invoking the `setSBFOutput` command to enable a given block, the block name should be specified.

The list of SBF blocks available on your receiver can be found in Appendix B.

4.1.3 SBF Block Time Stamp (TOW and WNC)

Each SBF header is directly followed by a time stamp, which consists of two fields: TOW and WNC:

Parameter	Type	Units & Scale		Do-Not-Use	Description
		Factor	Value		
TOW	u4	0.001 s	4294967295		Time-Of-Week : Time-tag, expressed in whole milliseconds from the beginning of the current GPS week.
WNC	u2	1 week	65535		The GPS week number associated with the TOW. WNC is a continuous week count (hence the "c"). It is not affected by GPS week rollovers, which occur every 1024 weeks. By definition of the Galileo system time, WNC is also the Galileo week number plus 1024.

In the SBF time stamps, the definition of the week always follows the GPS convention even if the block contains data for another constellation. This means that WNC 0, TOW 0 corresponds to Jan 06,1980 at 00:00:00 UTC.

If the time-of-week or the week number is unknown, which is typically the case for a few seconds after start-up, the corresponding field is set to its Do-Not-Use value (see section 4.1.7). It does not mean that the SBF block is unusable, but simply that the receiver could not time-tag it. It is typical that the TOW field becomes valid before the WNC field.

The interpretation to give to the time stamp is block-dependent. Three types of time stamps are possible:

- *Receiver time stamp*: this type of time stamp is used for the SBF blocks containing synchronous data, i.e. data generated at a given epoch in the receiver time scale. Examples of such blocks are the measurement and PVT blocks (`MeasEpoch` and `PVTCartesian`). The time stamp is always a multiple of the output interval as specified by the `setSBFOutput` command (see also section 4.1.8). As soon as the receiver time is aligned with the GNSS time, the receiver time stamp is guaranteed to never decrease in successive SBF blocks.
- *SIS time stamp*: it is used for asynchronous blocks containing navigation message data from the signal-in-space. The time stamp corresponds to the time of transmission of the end of the last navigation bit used to build the SBF block. It always follows the GPS convention, as explained above.
- *External time stamp*: this type of time stamp is used for SBF blocks triggered by external asynchronous events, such as the `ExtEvent` block.

For the blocks with a SIS or an external time stamp, there is no strict relation between the time stamp of the SBF blocks and their order of transmission. For example, the SBF stream may contain a `GPSNav` block with ephemeris parameters received one hour in the past (i.e. the time stamp is one hour in the past) followed by another block with a current receiver time stamp.

4.1.4 Sub-blocks

Some blocks contain sub-blocks. For example, the `SatVisibility` block contains `N SatInfo` sub-blocks, each sub-block containing data for one particular satellite. Unless the size of the sub-blocks is mentioned explicitly in the block description, SBF blocks that contain sub-blocks also contain a `SBLength` field, which indicates the size of the sub-blocks in bytes.

4.1.5 Padding Bytes

Padding bytes are foreseen at the end of most SBF blocks and sub-blocks, so that their total size is equal to `Length` or `SBLength` respectively. The padding bytes are just placeholders and should not be looked at by the decoding software. Their value is not defined.

4.1.6 SBF Revision Number

Each SBF block has an associated revision number. The revision number is incremented each time a backwards-compatible change is implemented.

As described in section 4.1.1, the block number is to be found in bits 0 to 12 of the `ID` field, and the revision is in bits 13 to 15 of that field.

A backwards-compatible change consists of adding one or more fields in the padding bytes, or in the fields marked as "reserved" in the block description. Such change should be unnoticed by properly written decoding software that ignore the contents of padding and reserved fields (see also section 4.1.12). Each time such change happens, the revision number is incremented. The revision at which a given field has been introduced is documented in the block description in chapter 4.2, unless that revision is 0 (see the `ReceiverSetup` block as an example). It is guaranteed that if a given field exists in revision `N`, it will also exist in all revisions after `N`: no fields are withdrawn from SBF.

4.1.7 Do-Not-Use Value

It might happen that one or more pieces of data in an SBF block are not known at block creation time. For example, when there are insufficient satellite measurements to compute a position solution, the position components found in the `X`, `Y` and `Z` fields of the `PVTCartesian` block will not be available. To indicate that a given data item is not available or is currently not provided by the receiver, the corresponding field is set to a 'Do-Not-Use' value that is never reached in normal operation.

When applicable, the Do-Not-Use value is mentioned in the block description. The Do-Not-Use value refers to the raw contents of the field, without applying the scale factor. A field set to its Do-Not-Use value should always be discarded by the decoding software.

4.1.8 Output Rate

In general, the default output rate for each SBF block is the renewal rate of the information. For instance, the `GPSNav` block is output each time a new ephemeris data set is received

from a given GPS satellite. The default output rates of GNSS measurement blocks, PVT blocks and integrated INS/GNSS blocks depend on your permission set. These three rates can be checked by the command **getReceiverCapabilities**.

The default output rate is specified for each block in chapter 4.2. To instruct the receiver to output a given block at its default rate, the "OnChange" rate has to be specified in the **setSBFOutput** command.

Some blocks can only be output at their default rate (e.g. the `GPSNav` block). Others can be decimated to a user-selectable rate. A subset of blocks can also be output "once" using the **exeSBFOnce** command. This can be handy to get a one-shot overview of a particular receiver state. Whether a given block supports a user-selectable rate ("Flex Rate") and whether it belongs to the "output once" set is indicated in the SBF block list in Appendix B.

Attempting to force another rate than the default one for those blocks that do not support "Flex Rate" has no effect: those blocks are always output at their default rate.

4.1.9 Satellite ID and GLONASS Frequency Number

Satellites are identified by the `SVID` (or `PRN`) and `FreqNr` fields, defined as in the table below.

 This table is only valid for the currently-supported constellations and signal types (see 4.1.10). To ensure compatibility with future SBF upgrades, decoding software must ignore SBF blocks and sub-blocks of which the satellite ID field or the signal number field is undefined in this document.

Field	Type	Do-Not-Use	Description	RINEX satellite code
Value				
SVID or PRN	u1	0	Satellite ID: The following ranges are defined: 1-37: PRN number of a GPS satellite 38-61: Slot number of a GLONASS satellite with an offset of 37 (R01 to R24) 62: GLONASS satellite of which the slot number is not known 63-68: Slot number of a GLONASS satellite with an offset of 38 (R25 to R30) 71-106: PRN number of a GALILEO satellite with an offset of 70 107-119: L-Band (MSS) satellite. Corresponding satellite name can be found in the <code>LBandBeams</code> block. 120-140: PRN number of an SBAS satellite (S120 to S140) 141-180: PRN number of a BeiDou satellite with an offset of 140 181-187: PRN number of a QZSS satellite with an offset of 180 191-197: PRN number of a NavIC/IRNSS satellite with an offset of 190 (I01 to I07) 198-215: PRN number of an SBAS satellite with an offset of 57 (S141 to S158) 216-222: PRN number of a NavIC/IRNSS satellite with an offset of 208 (I08 to I14) 223-245: PRN number of a BeiDou satellite with an offset of 182 (C41 to C63)	<i>Gnn</i> (<i>nn</i> = SVID) <i>Rnn</i> (<i>nn</i> = SVID-37) NA <i>Rnn</i> (<i>nn</i> = SVID-38) <i>Enn</i> (<i>nn</i> = SVID-70) NA <i>Snn</i> (<i>nn</i> = SVID-100) <i>Cnn</i> (<i>nn</i> = SVID-140) <i>Jnn</i> (<i>nn</i> = SVID-180) <i>Inn</i> (<i>nn</i> = SVID-190) <i>Snn</i> (<i>nn</i> = SVID-157) <i>Inn</i> (<i>nn</i> = SVID-208) <i>Cnn</i> (<i>nn</i> = SVID-182)
FreqNr	u1	0	GLONASS frequency number, with an offset of 8. It ranges from 1 (corresponding to an actual frequency number of -7) to 21 (corresponding to an actual frequency number of 13). For non-GLONASS satellites, <code>FreqNr</code> is reserved and must be ignored by the decoding software.	

4.1.10 Signal Type

Some sub-blocks contain a signal type field, which identifies the type of signal and modulation the sub-blocks applies to. The signal numbering is defined as follows:

Signal number	Signal Type	Constellation	Carrier frequency (MHz)	RINEX v3.04 obs code
0	L1CA	GPS	1575.42	1C
1	L1P	GPS	1575.42	1W
2	L2P	GPS	1227.60	2W
3	L2C	GPS	1227.60	2L
4	L5	GPS	1176.45	5Q
5	L1C	GPS	1575.42	1L
6	L1CA	QZSS	1575.42	1C
7	L2C	QZSS	1227.60	2L
8	L1CA	GLONASS	1602.00+(FreqNr-8)*9/16, with FreqNr as defined in section 4.1.9.	1C
9	L1P	GLONASS	1602.00+(FreqNr-8)*9/16	1P
10	L2P	GLONASS	1246.00+(FreqNr-8)*7/16	2P
11	L2CA	GLONASS	1246.00+(FreqNr-8)*7/16	2C
12	L3	GLONASS	1202.025	3Q
13	B1C	BeiDou	1575.42	1P
14	B2a	BeiDou	1176.45	5P
15	L5	NavIC/IRNSS	1176.45	5A
16	Reserved			
17	E1 (L1BC)	Galileo	1575.42	1C
18	Reserved			
19	E6 (E6BC)	Galileo	1278.75	6C
20	E5a	Galileo	1176.45	5Q
21	E5b	Galileo	1207.14	7Q
22	E5 AltBoc	Galileo	1191.795	8Q
23	LBand	MSS	L-band beam specific	NA
24	L1CA	SBAS	1575.42	1C
25	L5	SBAS	1176.45	5I
26	L5	QZSS	1176.45	5Q
27	L6	QZSS	1278.75	
28	B1I	BeiDou	1561.098	2I
29	B2I	BeiDou	1207.14	7I
30	B3I	BeiDou	1268.52	6I
31	Reserved			
32	L1C	QZSS	1575.42	1L
33	L1S	QZSS	1575.42	1Z
34	B2b	BeiDou	1207.14	7D
35	Reserved			

4.1.11 Channel Numbering

Some blocks contain a reference to the receiver channel number. Channel numbering starts at one. The maximum value for the channel number depends on the receiver type.

4.1.12 Decoding of SBF Blocks

In order to decode an SBF block, one has to identify the block boundaries in the data stream coming from the receiver. This involves searching for the initial "\$@" characters that mark the beginning of each SBF block. Since the "\$@" sequence can occur in the middle of an SBF block as well, additional checking is needed to make sure that a given "\$@" is indeed the beginning of a block. The following procedure is recommended to decode SBF data stream.

1. Wait until the "\$@" character sequence appears in the data stream from the receiver. When it is found, go to point 2.
2. Read the next two bytes. It should be the block CRC. Store this value for future reference.
3. Read the next two bytes and store them in a buffer. It should be the block ID.
4. Read the next two bytes and append them to the buffer. It should be the `Length` field of the SBF block. It should be a multiple of 4. If not, go back to point 1.
5. Read the next $(Length-8)$ bytes and append them to the buffer. Compute the CRC of the buffer. The computed CRC should be equal to the CRC stored at point 2. If not, go back to point 1, else a valid SBF block has been detected and can be interpreted by the reading software.
6. If the block number (bits 0 to 12 of the `ID` field decoded at point 3) is of interest to your application, decode the SBF block.
7. Go back to point 1 and search for the new occurrence of the "\$@" sequence after the end of the last byte of the block that was just identified.

To ensure compatibility with future upgrades of SBF, it is recommended that the decoding software observes the following rules:

- Only bits 0 to 12 of the `ID` field must be used to identify a block. Bits 13 to 15 represent the revision number.
- The lengths of SBF blocks and sub-blocks should not be considered constant and hard-coded in the decoding software. Instead, the decoding software must use the `Length` and `SBlockLength` fields encoded in the SBF block.
- Padding bytes should be ignored.
- Reserved fields and reserved bits in bit-fields should be ignored.
- SBF blocks or sub-blocks of which the satellite ID field or the signal number field is undefined in this document should be ignored (see section 4.1.9).

4.2 SBF Block Definitions

4.2.1 Measurement Blocks

GNSS observables are available in the following SBF blocks:

- the legacy `MeasEpoch` block, possibly complemented by `MeasExtra`.
- the `Meas3Ranges` block, possibly complemented by `Meas3Doppler` and `Meas3CN0HiRes`.

The `MeasEpoch` block contains pseudorange, carrier phase, C/N0 and Doppler observables. The `Meas3Ranges` block contains pseudoranges, carrier phases and C/N0, while Doppler is available in the companion `Meas3Doppler` block. The observable resolution is shown in the table below.

	<code>MeasEpoch</code>	<code>Meas3Ranges</code>
Pseudorange	1mm	1mm
Carrier phase	0.001cycles	0.001cycles
C/N0	0.25dB-Hz 0.03125dB-Hz with <code>MeasExtra</code>	1dB-Hz 0.0625dB-Hz with <code>Meas3CN0HiRes</code>
Doppler	0.0001Hz	No Doppler in <code>Meas3Ranges</code> 1mm/s with <code>Meas3Doppler</code>

The main advantage of the `Meas3` blocks is their reduced size compared to the `MeasEpoch` blocks. As an illustration, the following table shows the disk space required to log the different measurement-related blocks over one day at a 1-s interval. In this example, measurements from all GPS L1/L2/L5, GLONASS L1/L2, Galileo E1/E6/E5a/E5b and BeiDou B1/B2/B3 signals have been logged (constellation status as of beginning of 2017).

SBF Block	Disk space (1 day, 1 Hz)
<code>MeasEpoch</code>	104MB
<code>MeasExtra</code>	110MB
<code>Meas3Ranges</code>	28MB
<code>Meas3Doppler</code>	10MB
<code>Meas3CN0HiRes</code>	5MB

MeasEpoch	Number:	4027
	"OnChange" interval:	internal measurement rate (receiver-type dependent)

This block contains all the GNSS measurements (observables) taken at the time given by the `TOW` and `WNc` fields.

For each tracked signal, the following measurement set is available:

- the pseudorange
- the carrier phase
- the Doppler
- the C/N0
- the lock-time.

To decrease the block size, all the measurements from a given satellite are referenced to one master measurement set. For instance, the L2 pseudorange (C2) is not much different from the L1 pseudorange (C1), such that the difference between C2 and C1 is encoded, instead of the absolute value of C2.

This is done by using a two-level sub-block structure. All the measurements from a given satellite are stored in a `MeasEpochChannelType1` sub-block. The first part of this sub-block contains the master measurements, encoded as absolute values. The second part contains slave measurements, for which only the delta values are encoded in smaller `MeasEpochChannelType2` sub-blocks.

Every `MeasEpochChannelType1` sub-block contains a field "N2", which gives the number of nested `MeasEpochChannelType2` sub-blocks. If there is only one signal tracked for a given satellite, there are no slave measurements and N2 is set to 0.

Decoding is done as follows:

1. Decode the master measurements and the N2 value from the `MeasEpochChannelType1` sub-block.
2. If N2 is not 0, decode the N2 nested `MeasEpochChannelType2` sub-blocks.
3. Go back to 1 till the N1 `MeasEpochChannelType1` sub-blocks have been decoded.



Note that measurements in this block are scrambled if the "Measurement Availability" permission is not granted on your receiver. See also bit 7 of the `CommonFlags` field.

Parameter	Type	Units	Do-Not-Use	Description
Sync1	c1			Block Header, see 4.1.1
Sync2	c1			
CRC	u2			
ID	u2			
Length	u2	1 byte		
TOW	u4	0.001 s	4294967295	Receiver time stamp, see 4.1.3
WNc	u2	1 week	65535	
N1	u1			Number of <code>MeasEpochChannelType1</code> sub-blocks in this <code>MeasEpoch</code> block.
SB1Length	u1	1 byte		Length of a <code>MeasEpochChannelType1</code> sub-block, excluding the nested <code>MeasEpochChannelType2</code> sub-blocks
SB2Length	u1	1 byte		Length of a <code>MeasEpochChannelType2</code> sub-block
CommonFlags	u1			Bit field containing flags common to all measurements. Bit 0: Multipath mitigation: if this bit is set, multipath mitigation is enabled. (see the <code>setMultipathMitigation</code> command). Bit 1: Smoothing of code: if this bit is set, at least one of the code measurements are smoothed values (see <code>setSmoothingInterval</code> command). Bit 2: Carrier phase align: if this bit is set, the fractional part of the carrier phase measurements from different modulations on the same carrier frequency (e.g. GPS L2C and L2P) are aligned, i.e. multiplexing biases (0.25 or 0.5 cycles) are corrected. Aligned carrier phase measurements can be directly included in RINEX files. If this bit is unset, this block contains raw carrier phase measurements. This bit is always set in the current firmware version. Bit 3: Clock steering: this bit is set if clock steering is active (see <code>setClockSyncThreshold</code> command). Bit 4: Not applicable. Bit 5: High dynamics: this bit is set when the receiver is in high-dynamics mode (see the <code>setReceiverDynamics</code> command). Bit 6: Reserved Bit 7: Scrambling: bit set when the measurements are scrambled. Scrambling is applied when the "Measurement Availability" permission is not granted (see the <code>lif, Permissions</code> command).
CumClkJumps	u1	0.001 s		Cumulative millisecond clock jumps since start-up, with an ambiguity of $k \cdot 256$ ms. For example, if two clock jumps of -1 ms have occurred since startup, this field contains the value 254.
Reserved	u1			Reserved for future use, to be ignored by decoding software
Type1		A succession of <code>N1</code> <code>MeasEpochChannelType1</code> sub-blocks, see definition below
Padding	u1[.]			Padding bytes, see 4.1.5

Rev 1

MeasEpochChannelType1 sub-block definition:

Parameter	Type	Units	Do-Not-Use	Description
RxChannel	u1			Receiver channel on which this satellite is currently tracked (see 4.1.11).
Type	u1			Bit field indicating the signal type and antenna ID: Bits 0-4: <code>SigIdxLo</code> : if not 31, this is the signal number (see 4.1.10), otherwise the signal number can be found in the <code>ObsInfo</code> field below. Bits 5-7: Antenna ID: 0 for main, 1 for <code>Aux1</code> and 2 for <code>Aux2</code>

SVID	u1			Satellite ID, see 4.1.9
Misc	u1	4294967.296 m	0 ⁽¹⁾	<p>Bit field containing the MSB of the pseudorange.</p> <p>Bits 0-3: CodeMSB: MSB of the pseudorange (this is an unsigned value).</p> <p>Bits 4-7: Reserved</p>
CodeLSB	u4	0.001 m	0 ⁽¹⁾	<p>LSB of the pseudorange. The pseudorange expressed in meters is computed as follows:</p> $PR_{type1}[m] = (CodeMSB * 4294967296 + CodeLSB) * 0.001$ <p>where CodeMSB is part of the Misc field.</p>
Doppler	i4	0.0001 Hz	-2147483648	<p>Carrier Doppler (positive for approaching satellites). To compute the Doppler in Hz, use:</p> $D_{type1}[Hz] = Doppler * 0.0001$
CarrierLSB	u2	0.001 cycles	0 ⁽²⁾	LSB of the carrier phase relative to the pseudorange
CarrierMSB	i1	65.536 cycles	-128 ⁽²⁾	<p>MSB of the carrier phase relative to the pseudorange. The full carrier phase can be computed by:</p> $L[cycles] = PR_{type1}[m] / \lambda + (CarrierMSB * 65536 + CarrierLSB) * 0.001$ <p>where λ is the carrier wavelength corresponding to the frequency of the signal type in the Type field above: $\lambda = 299792458 / f_L$ m, with f_L the carrier frequency as listed in section 4.1.10.</p>
CN0	u1	0.25 dB-Hz	255	<p>The C/N0 in dB-Hz is computed as follows, depending on the signal type in the Type field:</p> $C/N_0[dB-Hz] = CN_0 * 0.25$ if the signal number is 1 or 2 $C/N_0[dB-Hz] = CN_0 * 0.25 + 10$ otherwise <p>Users requiring a higher C/N0 resolution can use the MeasExtra SBF block. The Misc field of that block allows to extend the resolution to 0.03125dB-Hz.</p>
LockTime	u2	1 s	65535	<p>Duration of continuous carrier phase. The lock-time is reset at the initial lock of the phase-locked-loop, and whenever a loss of lock condition occurs.</p> <p>If the lock-time is longer than 65534s, it is clipped to 65534s.</p> <p>If the carrier phase measurement is not available, this field is set to its Do-Not-Use value.</p>
ObsInfo	u1			<p>Bit field:</p> <p>Bit 0: if set, the pseudorange measurement is smoothed</p> <p>Bit 1: Reserved</p> <p>Bit 2: this bit is set when the carrier phase (L) has a half-cycle ambiguity</p> <p>Bits 3-7: The interpretation of these bits depends on the value of SigIdxLo from the Type field.</p> <p>If SigIdxLo equals 31, these bits contain the signal number with an offset of 32 (see 4.1.10). For example, a value of 1 corresponds to signal number 33 (QZSS L1S).</p> <p>If SigIdxLo is 8, 9, 10 or 11, these bits contain the GLONASS frequency number with an offset of 8. For example, a value of 1 corresponds to frequency number -7.</p> <p>Otherwise, these bits are reserved.</p>
N2	u1			Number of MeasEpochChannelType2 sub-blocks contained in this MeasEpochChannelType1 sub-block.

⁽¹⁾ The pseudorange is invalid if both CodeMSB is 0 and CodeLSB is 0.

⁽²⁾ The carrier phase is invalid if both CarrierMSB is -128 and CarrierLSB is 0.

Padding	u1[.]			Padding bytes, see 4.1.5
Type2		A succession of N_2 MeasEpochChannelType2 sub-blocks, see definition below

MeasEpochChannelType2 sub-block definition:

Parameter	Type	Units	Do-Not-Use	Description
Type	u1			Bit field indicating the signal type and antenna ID: Bits 0-4: SigIdxLo: if not 31, this is the signal number (see 4.1.10), otherwise the signal number can be found in the ObsInfo field below. Bits 5-7: Antenna ID: 0 for main, 1 for Aux1 and 2 for Aux2
LockTime	u1	1 s	255	See corresponding field in the MeasEpochChannelType1 sub-block above, except that the value is clipped to 254 instead of 65534.
CNO	u1	0.25 dB-Hz	255	See corresponding field in the MeasEpochChannelType1 sub-block above.
OffsetsMSB	u1	65.536 m 6.5536 Hz	-4 ⁽³⁾ -16 ⁽⁴⁾	Bit field containing the MSB of the code and of the Doppler offsets with respect to the MeasEpochChannelType1 sub-block. Bits 0-2: CodeOffsetMSB: MSB of the code offset. Bits 3-7: DopplerOffsetMSB: MSB of the Doppler offset. CodeOffsetMSB and DopplerOffsetMSB are coded as two's complement. Refer to the CodeOffsetLSB and DopplerOffsetLSB fields to see how to use this field.
CarrierMSB	i1	65.536 cycles	-128 ⁽⁵⁾	MSB of the carrier phase relative to the pseudorange.
ObsInfo	u1			Bit field: Bit 0: if set, the pseudorange measurement is smoothed Bit 1: Reserved Bit 2: this bit is set when the carrier phase (L) has a half-cycle ambiguity Bits 3-7: If SigIdxLo from the Type field of this sub-block equals 31, these bits contain the signal number with an offset of 32 (see 4.1.10), e.g. 1 corresponds to signal number 33 (QZSS L1S). Otherwise they are reserved and must be ignored by the decoding software.
CodeOffsetLSB	u2	0.001 m	0 ⁽³⁾	LSB of the code offset with respect to pseudorange in the MeasEpochChannelType1 sub-block. To compute the pseudorange, use: $PR_{type2} [m] = PR_{type1} [m] + (CodeOffsetMSB * 65536 + CodeOffsetLSB) * 0.001$
CarrierLSB	u2	0.001 cycles	0 ⁽⁵⁾	LSB of the carrier phase relative to the pseudorange. The full carrier phase can be computed by: $L[cycles] = PR_{type2} [m] / \lambda + (CarrierMSB * 65536 + CarrierLSB) * 0.001$ where λ is the carrier wavelength corresponding to the signal type in the Type field.

⁽³⁾ The pseudorange is invalid if both CodeOffsetMSB is -4 and CodeOffsetLSB is 0.

⁽⁴⁾ The Doppler is invalid if both DopplerOffsetMSB is -16 and DopplerOffsetLSB is 0.

⁽⁵⁾ The carrier phase is invalid if both CarrierMSB is -128 and CarrierLSB is 0.

DopplerOffsetLSB	u2	0.0001 Hz	0 ⁽⁴⁾	<p>LSB of the Doppler offset relative to the Doppler in the MeasEpochChannelType1 sub-block. To compute the Doppler, use:</p> $D_{\text{type2}}[\text{Hz}] = D_{\text{type1}}[\text{Hz}] * \alpha + (\text{DopplerOffsetMSB} * 65536 + \text{DopplerOffsetLSB}) * 1e-4,$ <p>where α is the ratio of the carrier frequency corresponding to the observable type in this MeasEpochChannelType2 sub-block, and that of the master observable type in the parent MeasEpochChannelType1 sub-block (see section 4.1.10 for a list of all carrier frequencies).</p>
Padding	u1[..]			Padding bytes, see 4.1.5

MeasExtra	Number: 4000 "OnChange" interval: internal measurement rate (receiver-type dependent)
-----------	--

This block contains extra information associated with the measurements contained in the MeasEpoch block, such as the internal corrections parameters applied during the measurement pre-processing, and the noise variances.

Parameter	Type	Units	Do-Not-Use	Description
Sync1	c1			Block Header, see 4.1.1
Sync2	c1			
CRC	u2			
ID	u2			
Length	u2	1 byte		
TOW	u4	0.001 s	4294967295	Receiver time stamp, see 4.1.3
WNc	u2	1 week	65535	
N	u1			Number of sub-blocks in this MeasExtra block.
SBLength	u1	1 byte		Length of a sub-block
DopplerVarFactor	f4	1 Hz ² / cycle ²		Factor to be used to compute the Doppler variance from the carrier phase variance. More specifically, the Doppler variance in mHz ² can be computed by: $\sigma_{\text{Doppler}}^2 [\text{mHz}^2] = \text{CarrierVariance} * \text{DopplerVarFactor},$ Where CarrierVariance can be found for each measurement type in the MeasExtraChannelSub sub-blocks.
ChannelSub		A succession of N MeasExtraChannelSub sub-blocks, see definition below
Padding	u1[..]			Padding bytes, see 4.1.5

MeasExtraChannelSub sub-block definition:

Parameter	Type	Units	Do-Not-Use	Description
RxChannel	u1			Receiver channel on which this satellite is currently tracked (see 4.1.11).
Type	u1			Bit field indicating the signal type and antenna ID: Bits 0-4: SigIdxLo: if not 31, this is the signal number (see 4.1.10), otherwise the signal number can be found in the Misc field below. A value of 31 can only happen on block revision 3 or above. Bits 5-7: Antenna ID: 0 for main, 1 for Aux1 and 2 for Aux2
MPCorrection	i2	0.001 m		Multipath correction applied to the pseudorange. This number has to be added to the pseudorange to recover the raw pseudorange as it would be if multipath mitigation was not used.
SmoothingCorr	i2	0.001 m		Smoothing correction applied to the pseudorange. This number has to be added to the pseudorange to recover the raw pseudorange as it would be if smoothing was disabled.
CodeVar	u2	0.0001 m ²	65535	Estimated code tracking noise variance. If the variance is larger than 65534 cm ² , it is clipped to 65534 cm ² .
CarrierVar	u2	1 mcycle ²	65535	Estimated carrier tracking noise variance. This value can be multiplied by DopplerVarFactor to compute the Doppler measurement variance. If the variance is larger than 65534 mcycles ² , it is clipped to 65534 mcycles ² .
LockTime	u2	1 s	65535	Duration of continuous carrier phase. The lock-time is reset at the initial lock after a signal (re)acquisition. If the lock-time is longer than 65534s, it is clipped to 65534s. If the carrier phase measurement is not available, this field is set to its Do-Not-Use value.
CumLossCont	u1			Carrier phase cumulative loss-of-continuity counter (modulo 256) for the signal type, antenna and satellite this sub-block refers to. This counter starts at zero at receiver start-up, and is incremented at each initial lock after signal (re)acquisition, or when a cycle slip is detected.
CarMPCorr	i1	1.953125 mcycle		Multipath correction applied to the carrier phase, in units of 1/512 cycles. This number has to be added to the carrier phase to recover the raw phase as it would be if multipath mitigation was not used.
Info	u1			Bit field: Bits 0-3: Reserved. Bits 4-7: Reserved.
Misc	u1	0.03125 dB-Hz		Bit field: Bits 0-2: CN0HighRes: high-resolution extension of the C/N0 (unsigned value from 0 to 7). The C/N0 value in the MeasEpoch SBF block has a resolution of 0.25dB-Hz. CN0HighRes can be used to extend the resolution to 0.03125dB-Hz. The high-resolution C/N0, in dB-Hz, is computed as follows: $C/N_{0,HighRes} = C/N_{0,MeasEpoch} + CN0HighRes * 0.03125.$ where $C/N_{0,MeasEpoch}$ is the C/N0 value coming from the MeasEpoch SBF block. Bits 3-7: If SigIdxLo from the Type field equals 31, these bits contain the signal number with an offset of 32 (see 4.1.10). Otherwise they are reserved.

Rev 1

Rev 2

Rev 3

Padding	u1[.]		Padding bytes, see 4.1.5
---------	-------	--	--------------------------

Meas3Ranges	Number:	4109
	"OnChange" interval:	internal measurement rate (receiver-type dependent)

This block contains all the code, carrier phase and C/N0 observables at a given measurement epoch. The resolution is 0.001m, 0.001cycles and 1dB-Hz for the code, carrier and C/N0 measurements respectively.

Applications requiring Doppler measurements can log the `Meas3Doppler` SBF block in addition to the `Meas3Ranges` block. Applications requiring extended C/N0 resolution (1/16dB-Hz) can log the `Meas3CN0HiRes` SBF block in addition to the `Meas3Ranges` block.

The advantage of this block compared to the `MeasEpoch` SBF block is its reduced size while offering the full resolution for the code and carrier measurements. One of the techniques used to reduce the size is to only encode full measurements (reference epochs) every N epochs. Between these reference epochs, `Meas3Ranges` contains delta epochs where the difference between the current measurements and the ones at the applicable reference epoch is encoded. The decoder must have received and stored the applicable reference epoch to be able to decode delta epochs. When streaming SBF over an unreliable communication link, if the reference epoch is lost, subsequent `Meas3Ranges` blocks cannot be decoded until the next reference epoch is received. The interval at which reference epochs are encoded can be controlled with the `setMeas3MaxRefInterval` command. A longer interval generally reduces the average block size, at the expense of a longer data gap in case a reference epoch is lost.

See also page 241 for additional information.



The format of this block and of the other `Meas3` blocks is complex and is not provided here. Details can be obtained from Septentrio Support. The `RxTools` installation contains the complete source code of a decoder in C language, together with `sbf2asc`, a small application showing how to use it. All C files can be found under the `sbf2asc` folder in the `RxTools` installation. The main measurement decoding function is `sbfread_MeasCollectAndDecode()` in the `sbfread_meas.c` file. Users interested in decoding the `Meas3` blocks are strongly advised to use the provided source code instead of writing their own decoder.

The detailed definition of this block is not available in this document.

Meas3CN0HiRes	Number: 4110 "OnChange" interval: internal measurement rate (receiver-type dependent)
---------------	--

The `Meas3CN0HiRes` block is an extension of the `Meas3Ranges` block containing the fractional part of the C/N0 values. The resolution of the C/N0 value in the `Meas3Ranges` SBF block is 1dB-Hz. Applications requiring a finer C/N0 resolution (0.0625dB-Hz) must log the `Meas3CN0HiRes` block together with the `Meas3Ranges` block.

The detailed definition of this block is not available in this document.

Meas3Doppler	Number: 4111 "OnChange" interval: internal measurement rate (receiver-type dependent)
--------------	--

The `Meas3Doppler` block is an extension of the `Meas3Ranges` block containing the range-rate (Doppler) values. Applications requiring range-rate or Doppler observables must log the `Meas3Doppler` block together with the `Meas3Ranges` block.

The detailed definition of this block is not available in this document.

Meas3PP	Number:	4112
	"OnChange" interval:	internal measurement rate (receiver-type dependent)

The `Meas3PP` block is an extension of the `Meas3Ranges` block containing various Septentrio-proprietary flags and values needed for accurate post-processing or re-processing of the PVT from the measurements in the `Meas3Ranges` SBF block. This block must be logged together with `Meas3Ranges`.

The detailed definition of this block is not available in this document.

Meas3MP	Number:	4113
	"OnChange" interval:	internal measurement rate (receiver-type dependent)

The `Meas3MP` block is an extension of the `Meas3Ranges` block containing the multipath correction applied by the receiver. It can be used for research purposes to undo the receiver multipath mitigation and revert to unmitigated data. This block must be logged together with `Meas3Ranges`.

The detailed definition of this block is not available in this document.

EndOfMeas	Number: 5922 "OnChange" interval: internal measurement rate (receiver-type dependent)
-----------	--

This block marks the end of the transmission of all measurement-related blocks belonging to a given epoch.

Parameter	Type	Units	Do-Not-Use	Description
Sync1	c1			Block Header, see 4.1.1
Sync2	c1			
CRC	u2			
ID	u2			
Length	u2	1 byte		
TOW	u4	0.001 s	4294967295	Receiver time stamp, see 4.1.3
WNc	u2	1 week	65535	

4.2.2 Navigation Page Blocks

GPSRawCA	Number: 4017
	"OnChange" interval: 6s

This block contains the 300 bits of a GPS C/A subframe. It is generated each time a new subframe is received, i.e. every 6 seconds.

Parameter	Type	Units	Do-Not-Use	Description
Sync1	c1			Block Header, see 4.1.1
Sync2	c1			
CRC	u2			
ID	u2			
Length	u2	1 byte		
TOW	u4	0.001 s	4294967295	SIS time stamp, see 4.1.3
WNc	u2	1 week	65535	
SVID	u1			Satellite ID, see 4.1.9
CRCPassed	u1			Status of the CRC or parity check: 0: CRC or parity check failed 1: CRC or parity check passed
ViterbiCnt	u1			Not applicable
Source	u1			Bit field: Bits 0-4: Signal type from which the bits have been received, as defined in 4.1.10 Bits 5-7: Reserved
FreqNr	u1			Not applicable
RxChannel	u1			Receiver channel (see 4.1.11).
NAVBits	u4[10]			NAVBits contains the 300 bits of a GPS C/A subframe. Encoding: For easier parsing, the bits are stored as a succession of 10 32-bit words. Since the actual words in the subframe are 30-bit long, two unused bits are inserted in each 32-bit word. More specifically, each 32-bit word has the following format: Bits 0-5: 6 parity bits (referred to as D_{25} to D_{30} in the GPS ICD), XOR-ed with the last transmitted bit of the previous word (D_{30}^*). Bits 6-29: source data bits (referred to as d_n in the GPS ICD). The first received bit is the MSB. Bits 30-31: Reserved
Padding	u1[.]			Padding bytes, see 4.1.5

GPSRawL2C	Number: 4018 "OnChange" interval: 12s
-----------	--

This block contains the 300 bits of a GPS L2C CNAV subframe (the so-called $D_c(t)$ data stream).

Parameter	Type	Units	Do-Not-Use	Description
Sync1	c1			Block Header, see 4.1.1
Sync2	c1			
CRC	u2			
ID	u2			
Length	u2	1 byte		
TOW	u4	0.001 s	4294967295	SIS time stamp, see 4.1.3
WNc	u2	1 week	65535	
SVID	u1			Satellite ID, see 4.1.9
CRCPassed	u1			Status of the CRC or parity check: 0: CRC or parity check failed 1: CRC or parity check passed
ViterbiCnt	u1			Viterbi decoder error count over the subframe
Source	u1			Bit field: Bits 0-4: Signal type from which the bits have been received, as defined in 4.1.10 Bits 5-7: Reserved
FreqNr	u1			Not applicable
RxChannel	u1			Receiver channel (see 4.1.11).
NAVBits	u4[10]			NAVBits contains the 300 bits of a GPS CNAV subframe. Encoding: NAVBits contains all the bits of the frame, including the preamble. The first received bit is stored as the MSB of NAVBits[0]. The unused bits in NAVBits[9] must be ignored by the decoding software.
Padding	u1[..]			Padding bytes, see 4.1.5

GPSRawL5	Number: 4019 "OnChange" interval: 6s
----------	---

This block contains the 300 bits of a GPS L5 CNAV subframe (the so-called $D_c(t)$ data stream).

Parameter	Type	Units	Do-Not-Use	Description
Sync1	c1			Block Header, see 4.1.1
Sync2	c1			
CRC	u2			
ID	u2			
Length	u2	1 byte		
TOW	u4	0.001 s	4294967295	SIS time stamp, see 4.1.3
WNc	u2	1 week	65535	
SVID	u1			Satellite ID, see 4.1.9
CRCPassed	u1			Status of the CRC or parity check: 0: CRC or parity check failed 1: CRC or parity check passed
ViterbiCnt	u1			Viterbi decoder error count over the subframe
Source	u1			Bit field: Bits 0-4: Signal type from which the bits have been received, as defined in 4.1.10 Bits 5-7: Reserved
FreqNr	u1			Not applicable
RxChannel	u1			Receiver channel (see 4.1.11).
NAVBits	u4[10]			NAVBits contains the 300 bits of a GPS CNAV subframe. Encoding: NAVBits contains all the bits of the frame, including the preamble. The first received bit is stored as the MSB of NAVBits[0]. The unused bits in NAVBits[9] must be ignored by the decoding software.
Padding	u1[.]			Padding bytes, see 4.1.5

GLORawCA	Number: 4026 "OnChange" interval: 2s
----------	---

This block contains the 85 bits of a GLONASS L1CA or L2CA navigation string.

Parameter	Type	Units	Do-Not-Use	Description
Sync1	c1			Block Header, see 4.1.1
Sync2	c1			
CRC	u2			
ID	u2			
Length	u2	1 byte		
TOW	u4	0.001 s	4294967295	SIS time stamp, see 4.1.3
WNc	u2	1 week	65535	
SVID	u1			Satellite ID, see 4.1.9
CRCPassed	u1			Status of the CRC or parity check: 0: CRC or parity check failed 1: CRC or parity check passed
ViterbiCnt	u1			Not applicable
Source	u1			Bit field: Bits 0-4: Signal type from which the bits have been received, as defined in 4.1.10 Bits 5-7: Reserved
FreqNr	u1			Frequency number, with an offset of 8. See 4.1.9
RxChannel	u1			Receiver channel (see 4.1.11).
NAVBits	u4[3]			NAVBits contains the first 85 bits of a GLONASS C/A string (i.e. all bits of the string with the exception of the time mark). Encoding: The first received bit is stored as the MSB of NAVBits[0]. The unused bits in NAVBits[2] must be ignored by the decoding software.
Padding	u1[.]			Padding bytes, see 4.1.5

GALRawFNAV	Number: 4022
	"OnChange" interval: 10s

This block contains the 244 bits of a Galileo F/NAV navigation page, after deinterleaving and Viterbi decoding.

Parameter	Type	Units	Do-Not-Use	Description
Sync1	c1			Block Header, see 4.1.1
Sync2	c1			
CRC	u2			
ID	u2			
Length	u2	1 byte		
TOW	u4	0.001 s	4294967295	SIS time stamp, see 4.1.3
WNc	u2	1 week	65535	
SVID	u1			Satellite ID, see 4.1.9
CRCPassed	u1			Status of the CRC or parity check: 0: CRC or parity check failed 1: CRC or parity check passed
ViterbiCnt	u1			Viterbi decoder error count over the page
Source	u1			Bit field: Bits 0-4: Signal type from which the bits have been received, as defined in 4.1.10 Bits 5-6: Reserved Bit 7: Reserved
FreqNr	u1			Not applicable
RxChannel	u1			Receiver channel (see 4.1.11).
NAVBits	u4[8]			NavBits contains the 244 bits of a Galileo F/NAV page. Encoding: NAVBits contains all the bits of the frame, with the exception of the synchronization field. The first received bit is stored as the MSB of NAVBits[0]. The unused bits in NAVBits[7] must be ignored by the decoding software.
Padding	u1[.]			Padding bytes, see 4.1.5

GALRawINAV	Number: 4023 "OnChange" interval: 2s
------------	---

This block contains the 234 bits of a Galileo I/NAV navigation page, after deinterleaving and Viterbi decoding.

Parameter	Type	Units	Do-Not-Use	Description
Sync1	c1			Block Header, see 4.1.1
Sync2	c1			
CRC	u2			
ID	u2			
Length	u2	1 byte		
TOW	u4	0.001 s	4294967295	SIS time stamp, see 4.1.3
WNc	u2	1 week	65535	
SVID	u1			Satellite ID, see 4.1.9
CRCPassed	u1			Status of the CRC or parity check: 0: CRC or parity check failed 1: CRC or parity check passed
ViterbiCnt	u1			Viterbi decoder error count over the page
Source	u1			Bit field: Bits 0-4: Signal type from which the bits have been received, as defined in 4.1.10 Bit 5: Set when the nav page is the concatenation of a sub-page received from E5b, and a sub-page received from L1BC. In that case, bits 0-4 are set to L1BC. Bit 6: Reserved Bit 7: Reserved
FreqNr	u1			Not applicable
RxChannel	u1			Receiver channel (see 4.1.11).
NAVBits	u4[8]			NAVBits contains the 234 bits of an I/NAV navigation page (in nominal or alert mode). Note that the I/NAV page is transmitted as two sub-pages (the so-called even and odd pages) of duration 1 second each (120 bits each). In this block, the even and odd pages are concatenated, even page first and odd page last. The 6 tails bits at the end of the even page are removed (hence a total of 234 bits). If the even and odd pages have been received from two different carriers (E5b and L1), bit 5 of the Source field is set. Encoding: NAVBits contains all the bits of the frame, with the exception of the synchronization field. The first received bit is stored as the MSB of NAVBits[0]. The unused bits in NAVBits[7] must be ignored by the decoding software.
Padding	u1[.]			Padding bytes, see 4.1.5

GEORawL1	Number: 4020 "OnChange" interval: 1s
----------	---

This block contains the 250 bits of a SBAS L1 navigation frame, after Viterbi decoding.

Parameter	Type	Units	Do-Not-Use	Description
Sync1	c1			Block Header, see 4.1.1
Sync2	c1			
CRC	u2			
ID	u2			
Length	u2	1 byte		
TOW	u4	0.001 s	4294967295	SIS time stamp, see 4.1.3
WNc	u2	1 week	65535	
SVID	u1			Satellite ID, see 4.1.9
CRCPassed	u1			Status of the CRC or parity check: 0: CRC or parity check failed 1: CRC or parity check passed
ViterbiCnt	u1			Viterbi decoder error count over the navigation frame
Source	u1			Bit field: Bits 0-4: Signal type from which the bits have been received, as defined in 4.1.10 Bits 5-7: Reserved
FreqNr	u1			Not applicable
RxChannel	u1			Receiver channel (see 4.1.11).
NAVBits	u4[8]			NAVBits contains the 250 bits of a SBAS navigation frame. Encoding: NAVBits contains all the bits of the frame, including the preamble. The first received bit is stored as the MSB of NAVBits[0]. The unused bits in NAVBits[7] must be ignored by the decoding software.
Padding	u1[.]			Padding bytes, see 4.1.5

GEORawL5	Number: 4021 "OnChange" interval: 1s
----------	---

This block contains the 250 bits of a SBAS L5 navigation frame, after Viterbi decoding.

Parameter	Type	Units	Do-Not-Use	Description
Sync1	c1			Block Header, see 4.1.1
Sync2	c1			
CRC	u2			
ID	u2			
Length	u2	1 byte		
TOW	u4	0.001 s	4294967295	SIS time stamp, see 4.1.3
WNc	u2	1 week	65535	
SVID	u1			Satellite ID, see 4.1.9
CRCPassed	u1			Status of the CRC or parity check: 0: CRC or parity check failed 1: CRC or parity check passed
ViterbiCnt	u1			Viterbi decoder error count over the navigation frame
Source	u1			Bit field: Bits 0-4: Signal type from which the bits have been received, as defined in 4.1.10 Bits 5-7: Reserved
FreqNr	u1			Not applicable
RxChannel	u1			Receiver channel (see 4.1.11).
NAVBits	u4[8]			NAVBits contains the 250 bits of a SBAS navigation frame. Encoding: NAVBits contains all the bits of the frame, including the preamble. The first received bit is stored as the MSB of NAVBits[0]. The unused bits in NAVBits[7] must be ignored by the decoding software.
Padding	u1[.]			Padding bytes, see 4.1.5

BDSRaw	Number: 4047
	"OnChange" interval: 6 seconds (non GEOs), 0.6 s (GEOs)

This block contains the 300 bits of a BeiDou navigation page, as received from the B1I, B2I or B3I signal.

Parameter	Type	Units	Do-Not-Use	Description
Sync1	c1			Block Header, see 4.1.1
Sync2	c1			
CRC	u2			
ID	u2			
Length	u2	1 byte		
TOW	u4	0.001 s	4294967295	SIS time stamp, see 4.1.3
WNc	u2	1 week	65535	
SVID	u1			Satellite ID, see 4.1.9
CRCPassed	u1			Status of the CRC or parity check: 0: CRC or parity check failed 1: CRC or parity check passed
ViterbiCnt	u1			Not applicable
Source	u1			Signal type from which the bits have been received, as defined in 4.1.10
Reserved	u1			Reserved for future use, to be ignored by decoding software.
RxChannel	u1			Receiver channel (see 4.1.11).
NAVBits	u4[10]			NAVBits contains the 300 deinterleaved bits of a BeiDou navigation subframe. Encoding: NAVBits contains all the bits of the subframe, including the preamble and the parity bits. The first received bit is stored as the MSB of NAVBits[0]. The 20 unused bits in NAVBits[9] must be ignored by the decoding software. The bits are deinterleaved.
Padding	u1[.]			Padding bytes, see 4.1.5

BDSRawB1C	Number: 4218 "OnChange" interval: 18s
-----------	--

This block contains the 1800 symbols of a BeiDou B-CNAV1 navigation frame (itself containing three subframes), as received from the B1C signal.

The symbols are deinterleaved. The receiver attempts to correct bit errors using the LDPC parity bits, but unrecoverable errors are still possible at low C/N0. It is therefore always needed to check the CRC status before using the navigation bits. A separate CRC check is provided for subframe 2 and 3.

Parameter	Type	Units	Do-Not-Use	Description
Sync1	c1			Block Header, see 4.1.1
Sync2	c1			
CRC	u2			
ID	u2			
Length	u2	1 byte		
TOW	u4	0.001 s	4294967295	SIS time stamp, see 4.1.3
WNc	u2	1 week	65535	
SVID	u1			Satellite ID, see 4.1.9
CRCSF2	u1			Status of the CRC check of subframe 2: 0: failed 1: passed
CRCSF3	u1			Status of the CRC check of subframe 3: 0: failed 1: passed
Source	u1			Signal type from which the bits have been received, as defined in 4.1.10
Reserved	u1			Reserved for future use, to be ignored by decoding software.
RxChannel	u1			Receiver channel (see 4.1.11).
NAVBits	u4[57]			NAVBits contains the 1800 deinterleaved symbols of a BeiDou B1C (B-CNAV1) navigation frame. Encoding: NAVBits contains all the symbols of the frame. The first received symbol (i.e. the first symbol of subframe 1) is stored as the MSB of NAVBits[0]. The 24 unused bits in NAVBits[56] must be ignored by the decoding software.
Padding	u1[.]			Padding bytes, see 4.1.5

BDSRawB2a	Number: 4219 "OnChange" interval: 3s
-----------	---

This block contains the 576 symbols of a BeiDou B-CNAV2 navigation frame, as received from the B2a signal.

The receiver attempts to correct bit errors using the LDPC parity bits, but unrecoverable errors are still possible at low C/N₀. It is therefore always needed to check the CRC status before using the navigation bits.

Parameter	Type	Units	Do-Not-Use	Description
Sync1	c1			Block Header, see 4.1.1
Sync2	c1			
CRC	u2			
ID	u2			
Length	u2	1 byte		
TOW	u4	0.001 s	4294967295	SIS time stamp, see 4.1.3
WNc	u2	1 week	65535	
SVID	u1			Satellite ID, see 4.1.9
CRCPassed	u1			Status of the CRC or parity check: 0: CRC or parity check failed 1: CRC or parity check passed
ViterbiCnt	u1			Not applicable
Source	u1			Signal type from which the bits have been received, as defined in 4.1.10
Reserved	u1			Reserved for future use, to be ignored by decoding software.
RxChannel	u1			Receiver channel (see 4.1.11).
NAVBits	u4[18]			NAVBits contains the 576 symbols of a BeiDou B2a (B-CNAV2) navigation frame. Encoding: NAVBits contains all the symbols of the frame, excluding the preamble. The first received symbol (i.e. the MSB of the PRN field) is stored as the MSB of NAVBits[0].
Padding	u1[.]			Padding bytes, see 4.1.5

QZSRawL1CA	Number:	4066
	"OnChange" interval:	6s

This block contains the 300 bits of a QZSS C/A subframe.

Parameter	Type	Units	Do-Not-Use	Description
Sync1	c1			Block Header, see 4.1.1
Sync2	c1			
CRC	u2			
ID	u2			
Length	u2	1 byte		
TOW	u4	0.001 s	4294967295	SIS time stamp, see 4.1.3
WNc	u2	1 week	65535	
SVID	u1			Satellite ID, see 4.1.9
CRCPassed	u1			Status of the CRC or parity check: 0: CRC or parity check failed 1: CRC or parity check passed
Reserved	u1			Reserved
Source	u1			Bit field: Bits 0-4: Signal type from which the bits have been received, as defined in 4.1.10 Bits 5-7: Reserved
Reserved2	u1			Reserved for future use, to be ignored by decoding software.
RxChannel	u1			Receiver channel (see 4.1.11).
NAVBits	u4[10]			NAVBits contains the 300 bits of a QZSS C/A subframe. Encoding: Same as GPSRawCA block.
Padding	u1[.]			Padding bytes, see 4.1.5

QZSRawL2C	Number: 4067 "OnChange" interval: 12s
-----------	--

This block contains the 300 bits of a QZSS L2C CNAV subframe.

Parameter	Type	Units	Do-Not-Use	Description
Sync1	c1			Block Header, see 4.1.1
Sync2	c1			
CRC	u2			
ID	u2			
Length	u2	1 byte		
TOW	u4	0.001 s	4294967295	SIS time stamp, see 4.1.3
WNc	u2	1 week	65535	
SVID	u1			Satellite ID, see 4.1.9
CRCPassed	u1			Status of the CRC or parity check: 0: CRC or parity check failed 1: CRC or parity check passed
ViterbiCnt	u1			Viterbi decoder error count over the subframe
Source	u1			Bit field: Bits 0-4: Signal type from which the bits have been received, as defined in 4.1.10 Bits 5-7: Reserved
Reserved	u1			Reserved for future use, to be ignored by decoding software.
RxChannel	u1			Receiver channel (see 4.1.11).
NAVBits	u4[10]			NAVBits contains the 300 bits of a QZSS CNAV subframe. Encoding: NAVBits contains all the bits of the frame, including the preamble. The first received bit is stored as the MSB of NAVBits[0]. The unused bits in NAVBits[9] must be ignored by the decoding software.
Padding	u1[..]			Padding bytes, see 4.1.5

QZSRawL5	Number: 4068
	"OnChange" interval: 6s

This block contains the 300 bits of a QZSS L5 CNAV subframe.

Parameter	Type	Units	Do-Not-Use	Description
Sync1	c1			Block Header, see 4.1.1
Sync2	c1			
CRC	u2			
ID	u2			
Length	u2	1 byte		
TOW	u4	0.001 s	4294967295	SIS time stamp, see 4.1.3
WNc	u2	1 week	65535	
SVID	u1			Satellite ID, see 4.1.9
CRCPassed	u1			Status of the CRC or parity check: 0: CRC or parity check failed 1: CRC or parity check passed
ViterbiCnt	u1			Viterbi decoder error count over the subframe
Source	u1			Bit field: Bits 0-4: Signal type from which the bits have been received, as defined in 4.1.10 Bits 5-7: Reserved
Reserved	u1			Reserved for future use, to be ignored by decoding software.
RxChannel	u1			Receiver channel (see 4.1.11).
NAVBits	u4[10]			NAVBits contains the 300 bits of a QZSS CNAV subframe. Encoding: NAVBits contains all the bits of the frame, including the preamble. The first received bit is stored as the MSB of NAVBits[0]. The unused bits in NAVBits[9] must be ignored by the decoding software.
Padding	u1[.]			Padding bytes, see 4.1.5

NAVICRaw	Number: 4093 "OnChange" interval: 12s
----------	--

This block contains the 292 bits of a NavIC/IRNSS subframe.

Parameter	Type	Units	Do-Not-Use	Description
Sync1	c1			Block Header, see 4.1.1
Sync2	c1			
CRC	u2			
ID	u2			
Length	u2	1 byte		
TOW	u4	0.001 s	4294967295	SIS time stamp, see 4.1.3
Wnc	u2	1 week	65535	
SVID	u1			Satellite ID, see 4.1.9
CRCPassed	u1			Status of the CRC or parity check: 0: CRC or parity check failed 1: CRC or parity check passed
ViterbiCnt	u1			Viterbi decoder error count over the subframe
Source	u1			Signal type from which the bits have been received, as defined in 4.1.10
Reserved	u1			Reserved for future use, to be ignored by decoding software.
RxChannel	u1			Receiver channel (see 4.1.11).
NAVBits	u4[10]			NavBits contains the 292 bits of a NavIC/IRNSS subframe. Encoding: NAVBits contains all the bits of the frame, with the exception of the preamble. The first received bit is stored as the MSB of NAVBits[0]. The unused bits in NAVBits[9] must be ignored by the decoding software.
Padding	u1[.]			Padding bytes, see 4.1.5

4.2.3 GPS Decoded Message Blocks

GPSTNav	Number: 5891 "OnChange" interval: block generated each time a new navigation data set is received from a GPS satellite
---------	---

The GPSTNav block contains the decoded navigation data for one GPS satellite. These data are conveyed in subframes 1 to 3 of the satellite navigation message. Refer to GPS ICD for further details.

Parameter	Type	Units	Do-Not-Use	Description
Sync1	c1			Block Header, see 4.1.1
Sync2	c1			
CRC	u2			
ID	u2			
Length	u2	1 byte		
TOW	u4	0.001 s	4294967295	SIS time stamp, see 4.1.3
WNc	u2	1 week	65535	
PRN	u1			ID of the GPS satellite of which the ephemeris is given in this block (see 4.1.9)
Reserved	u1			Reserved for future use, to be ignored by decoding software
WN	u2	1 week	65535	Week number (10 bits from subframe 1, word 3)
CAorPonL2	u1			Code(s) on L2 channel (2 bits from subframe 1, word 3)
URA	u1			User Range accuracy index (4 bits from subframe 1 word 3)
health	u1			6-bit health from subframe 1, word 3 (6 bits from subframe 1, word 3)
L2DataFlag	u1			Data flag for L2 P-code (1 bit from subframe 1, word 4)
IODC	u2			Issue of data, clock (10 bits from subframe 1)
IODE2	u1			Issue of data, ephemeris (8 bits from subframe 2)
IODE3	u1			Issue of data, ephemeris (8 bits from subframe 3)
FitIntFlg	u1			Curve Fit Interval, (1 bit from subframe 2, word 10)
Reserved2	u1			unused, to be ignored by decoding software
T_gd	f4	1 s		Estimated group delay differential
t_oc	u4	1 s		clock data reference time
a_f2	f4	1 s / s ²		SV clock aging
a_f1	f4	1 s / s		SV clock drift
a_f0	f4	1 s		SV clock bias
C_rs	f4	1 m		Amplitude of the sine harmonic correction term to the orbit radius
DEL_N	f4	1 semi-circle / s		Mean motion difference from computed value
M_0	f8	1 semi-circle		Mean anomaly at reference time
C_uc	f4	1 rad		Amplitude of the cosine harmonic correction term to the argument of latitude
e	f8			Eccentricity
C_us	f4	1 rad		Amplitude of the sine harmonic correction term to the argument of latitude
SQRT_A	f8	1 m ^{1/2}		Square root of the semi-major axis
t_oe	u4	1 s		Reference time ephemeris

C_ic	f4	1 rad		Amplitude of the cosine harmonic correction term to the angle of inclination
OMEGA_0	f8	1 semi-circle		Longitude of ascending node of orbit plane at weekly epoch
C_is	f4	1 rad		Amplitude of the sine harmonic correction term to the angle of inclination
i_0	f8	1 semi-circle		Inclination angle at reference time
C_rc	f4	1 m		Amplitude of the cosine harmonic correction term to the orbit radius
omega	f8	1 semi-circle		Argument of perigee
OMEGADOT	f4	1 semi-circle / s		Rate of right ascension
IDOT	f4	1 semi-circle / s		Rate of inclination angle
WNt_oc	u2	1 week		WN associated with t_oc, modulo 1024
WNt_oe	u2	1 week		WN associated with t_oe, modulo 1024
Padding	u1[.]			Padding bytes, see 4.1.5

GPSA1m	Number: 5892
	"OnChange" interval: block generated each time a new almanac data set is received from a GPS satellite

The GPSA1m block contains the decoded almanac data for one GPS satellite. These data are conveyed in subframes 4 and 5 of the satellite navigation message. Refer to GPS ICD for further details.

Parameter	Type	Units	Do-Not-Use	Description
Sync1	c1			Block Header, see 4.1.1
Sync2	c1			
CRC	u2			
ID	u2			
Length	u2	1 byte		
TOW	u4	0.001 s	4294967295	SIS time stamp, see 4.1.3
WNc	u2	1 week	65535	
PRN	u1			ID of the GPS satellite of which the almanac is given in this block (see 4.1.9)
Reserved	u1			Reserved for future use, to be ignored by decoding software
e	f4			Eccentricity
t_oa	u4	1 s		almanac reference time of week
delta_i	f4	1 semi-circle		Inclination angle at reference time, relative to $i_0 = 0.3$ semi-circles
OMEGADOT	f4	1 semi-circle / s		Rate of right ascension
SQRT_A	f4	1 m ^{1/2}		Square root of the semi-major axis
OMEGA_0	f4	1 semi-circle		Longitude of ascending node of orbit plane at weekly epoch
omega	f4	1 semi-circle		Argument of perigee
M_0	f4	1 semi-circle		Mean anomaly at reference time
a_f1	f4	1 s / s		SV clock drift
a_f0	f4	1 s		SV clock bias
WN_a	u1	1 week		Almanac reference week, to which t_oa is referenced
config	u1			Anti-spoofing and satellite configuration (4 bits from subframe 4, page 25)
health8	u1			health on 8 bits from the almanac page
health6	u1			health summary on 6 bits (from subframe 4, page 25 and subframe 5 page 25)
Padding	u1[.]			Padding bytes, see 4.1.5

GPSTion	Number:	5893
	"OnChange" interval:	block generated each time subframe 4, page 18, is received from a GPS satellite

The GPSTion block contains the decoded ionosphere data (the Klobuchar coefficients). These data are conveyed in subframes 4, page 18 of the satellite navigation message. Refer to GPS ICD for further details.

Parameter	Type	Units	Do-Not-Use	Description
Sync1	c1			Block Header, see 4.1.1
Sync2	c1			
CRC	u2			
ID	u2			
Length	u2	1 byte		
TOW	u4	0.001 s	4294967295	SIS time stamp, see 4.1.3
WNc	u2	1 week	65535	
PRN	u1			ID of the GPS satellite from which the coefficients have been received (see 4.1.9)
Reserved	u1			Reserved for future use, to be ignored by decoding software
alpha_0	f4	1 s		vertical delay coefficient 0
alpha_1	f4	1 s / semi-circle		vertical delay coefficient 1
alpha_2	f4	1 s / semi-circle ²		vertical delay coefficient 2
alpha_3	f4	1 s / semi-circle ³		vertical delay coefficient 3
beta_0	f4	1 s		model period coefficient 0
beta_1	f4	1 s / semi-circle		model period coefficient 1
beta_2	f4	1 s / semi-circle ²		model period coefficient 2
beta_3	f4	1 s / semi-circle ³		model period coefficient 3
Padding	u1[.]			Padding bytes, see 4.1.5

GPSUTC	Number: 5894
	"OnChange" interval: block generated each time subframe 4, page 18, is received from a GPS satellite

The GPSUTC block contains the decoded UTC data. These data are conveyed in subframes 4, page 18 of the satellite navigation message. Refer to GPS ICD for further details.

Parameter	Type	Units	Do-Not-Use	Description
Sync1	c1			Block Header, see 4.1.1
Sync2	c1			
CRC	u2			
ID	u2			
Length	u2	1 byte		
TOW	u4	0.001 s	4294967295	SIS time stamp, see 4.1.3
WNc	u2	1 week	65535	
PRN	u1			ID of the GPS satellite from which these UTC parameters have been received (see 4.1.9)
Reserved	u1			Reserved for future use, to be ignored by decoding software
A_1	f4	1 s / s		first order term of polynomial
A_0	f8	1 s		constant term of polynomial
t_ot	u4	1 s		reference time for UTC data
WN_t	u1	1 week		UTC reference week number, to which t_ot is referenced
DEL_t_LS	i1	1 s		Delta time due to leap seconds whenever the effectivity time is not in the past
WN_LSF	u1	1 week		Effectivity time of leap second (week)
DN	u1	1 day		Effectivity time of leap second (day, from 1 to 7)
DEL_t_LSF	i1	1 s		Delta time due to leap seconds whenever the effectivity time is in the past

4.2.4 GLONASS Decoded Message Blocks

GLONAV	Number: 4004 "OnChange" interval: block generated each time a new navigation data set is received from a GLONASS satellite
--------	---

The GLONAV block contains the decoded ephemeris data for one GLONASS satellite.

Parameter	Type	Units	Do-Not-Use	Description
Sync1	c1			Block Header, see 4.1.1
Sync2	c1			
CRC	u2			
ID	u2			
Length	u2	1 byte		
TOW	u4	0.001 s	4294967295	SIS time stamp, see 4.1.3
WNc	u2	1 week	65535	
SVID	u1			ID of the GLONASS satellite for which ephemeris is provided in this block (see 4.1.9).
FreqNr	u1			Frequency number of the GLONASS satellite for which ephemeris is provided in this block (see 4.1.9).
X	f8	1000 m		x-component of satellite position in PZ-90.02
Y	f8	1000 m		y-component of satellite position in PZ-90.02
Z	f8	1000 m		z-component of satellite position in PZ-90.02
Dx	f4	1000 m / s		x-component of satellite velocity in PZ-90.02
Dy	f4	1000 m / s		y-component of satellite velocity in PZ-90.02
Dz	f4	1000 m / s		z-component of satellite velocity in PZ-90.02
Ddx	f4	1000 m / s ²		x-component of satellite acceleration in PZ-90.02
Ddy	f4	1000 m / s ²		y-component of satellite acceleration in PZ-90.02
Ddz	f4	1000 m / s ²		z-component of satellite acceleration in PZ-90.02
gamma	f4	1 Hz / Hz		$\gamma_n(t_b)$: relative deviation of predicted carrier frequency
tau	f4	1 s		$\tau_n(t_b)$: time correction to GLONASS time
dtau	f4	1 s		$\Delta\tau_n$: time difference between L2 and L1 sub-band
t_oe	u4	1 s		reference time-of-week in GPS time frame
WN_toe	u2	1 week		reference week number in GPS time frame (modulo 1024)
P1	u1	1 minute		time interval between adjacent values of t_b
P2	u1			1-bit odd/even flag of t_b
E	u1	1 day		age of data
B	u1			3-bit health flag, satellite unhealthy if MSB set
t_b	u2	1 minute		time of day (center of validity interval)
M	u1			2-bit GLONASS-M satellite identifier (01, otherwise 00)
P	u1			2-bit mode of computation of time parameters
l	u1			1-bit health flag, 0=healthy, 1=unhealthy
P4	u1			1-bit 'updated' flag of ephemeris data
N_T	u2	1 day		current day number within 4-year interval
F_T	u2	0.01 m		predicted user range accuracy at time t_b
Padding	u1[.]			Padding bytes, see 4.1.5

GLOAlm	Number:	4005
	"OnChange" interval:	block generated each time a new almanac data set is received from a GLONASS satellite

The GLOAlm block contains the decoded navigation data for one GLONASS satellite.

Parameter	Type	Units	Do-Not-Use	Description
Sync1	c1			Block Header, see 4.1.1
Sync2	c1			
CRC	u2			
ID	u2			
Length	u2	1 byte		
TOW	u4	0.001 s	4294967295	SIS time stamp, see 4.1.3
WNc	u2	1 week	65535	
SVID	u1			ID of the GLONASS satellite for which almanac is provided in this block (see 4.1.9).
FreqNr	u1			Frequency number of the GLONASS satellite for which almanac is provided in this block (see 4.1.9). This number corresponds to the H_n^A parameter in the GLONASS ICD.
epsilon	f4			e_n^A : orbit eccentricity
t_oa	u4	1 s		Reference time-of-week in GPS time frame
Delta_i	f4	1 semi-circle		Δi_n^A : correction to inclination
lambda	f4	1 semi-circle		λ_n^A : Longitude of first ascending node
t_ln	f4	1 s		$t_{\lambda_n^A}$: time of first ascending node passage
omega	f4	1 semi-circle		ω_n^A : argument of perigee
Delta_T	f4	1 s / orbit-period		ΔT_n^A : correction to mean Draconian period
dDelta_T	f4	1 s / orbit-period ²		$d\Delta T_n^A$: rate of change correction to mean Draconian period
tau	f4	1 s		τ_n^A : coarse correction to satellite time
WN_a	u1	1 week		Reference week in GPS time frame (modulo 256)
C	u1			C_n^A : 1-bit general health flag (1 indicates healthy)
N	u2	1 day		N^A : calendar day number within 4 year period
M	u1			M_n^A : 2-bit GLONASS-M satellite identifier
N_4	u1			N_4 : 4 year interval number, starting from 1996
Padding	u1[.]			Padding bytes, see 4.1.5

GLOTime	Number:	4036	
	"OnChange" interval:	block generated at the end of each GLONASS super-frame, i.e. every 2.5 minutes.	

The GLOTime block contains the decoded non-immediate data related to the difference between GLONASS and GPS, UTC and UT1 time scales.

Parameter	Type	Units	Do-Not-Use	Description
Sync1	c1			Block Header, see 4.1.1
Sync2	c1			
CRC	u2			
ID	u2			
Length	u2	1 byte		
TOW	u4	0.001 s	4294967295	SIS time stamp, see 4.1.3
WNc	u2	1 week	65535	
SVID	u1			ID of the GLONASS satellite from which the data in this block has been decoded (see 4.1.9).
FreqNr	u1			Frequency number of the GLONASS satellite from which the data in this block has been decoded (see 4.1.9).
N_4	u1			4 year interval number, starting from 1996
KP	u1			notification of leap second
N	u2	1 day		calendar day number within 4 year period
tau_GPS	f4	$1 \cdot 10^9$ ns		difference with respect to GPS time
tau_c	f8	$1 \cdot 10^9$ ns		GLONASS time scale correction to UTC(SU)
B1	f4	1 s		difference between UT1 and UTC(SU)
B2	f4	1 s / msd		daily change of B1
Padding	u1[.]			Padding bytes, see 4.1.5

4.2.5 Galileo Decoded Message Blocks

GALNav	Number: 4002
	"OnChange" interval: output each time a new navigation data batch is decoded.

The GalNav block contains the following decoded navigation data for one Galileo satellite:

- orbital elements and clock corrections
- health, Signal-In-Space Accuracy (SISA) indexes and Broadcast Group Delays (BGDs) for each carrier or carrier combinations.

The interpretation of the clock correction parameters (t_{oc} , a_{f0} , a_{f1} , a_{f2}) depends on the value of the Source field:

Source	Message type	Applicable Clock Model
2	I/NAV	(L1,E5b)
16	F/NAV	(L1,E5a)

If the receiver is decoding both the I/NAV and the F/NAV data stream, it will output a GalNav block for the I/NAV stream, containing the (L1, E5b) clock model, and a different GalNav block for the F/NAV stream, containing the (L1, E5a) clock model.

Depending on the message type being decoded, some health, SISA or BGD values may not be available (in that case they are set to their respective Do-Not-Use values). The following health, SISA and BGD values are guaranteed to be available for a given value of the Source field:

Source	Health, SISA and BGD availability
2 (I/NAV)	At least L1-B _{DVS} , L1-B _{HS} , E5b _{DVS} , E5b _{HS} , SISA_L1E5b and BGD_L1E5b are available
16 (F/NAV)	At least E5a _{DVS} , E5a _{HS} , SISA_L1E5a and BGD_L1E5a are available

The IODNav field identifies the issue of data. All orbital elements, clock parameters and SISA values in the block are guaranteed to refer to the same data batch identified by IODNav. The fields Health_OSSOL, BGD_L1E5a, BGD_L1E5b and CNAVenc are not covered by the issue of data, and the block simply contains the latest received value.

Please refer to the Galileo Signal-In-Space ICD for the interpretation and usage of the parameters contained in this SBF block.

Parameter	Type	Units	Do-Not-Use	Description
Sync1	c1			Block Header, see 4.1.1
Sync2	c1			
CRC	u2			
ID	u2			
Length	u2	1 byte		SIS time stamp, see 4.1.3
TOW	u4	0.001 s	4294967295	
WNc	u2	1 week	65535	
SVID	u1			SVID of the Galileo satellite (see 4.1.9)

Source	u1			See table above: this field indicates how to interpret the clock correction parameters.
SQRT_A	f8	1 m ^{1/2}		Square root of the semi-major axis
M_0	f8	1 semi-circle		Mean anomaly at reference time
e	f8			Eccentricity
i_0	f8	1 semi-circle		Inclination angle at reference time
omega	f8	1 semi-circle		Argument of perigee
OMEGA_0	f8	1 semi-circle		Longitude of ascending node of orbit plane at weekly epoch
OMEGADOT	f4	1 semi-circle / s		Rate of right ascension
IDOT	f4	1 semi-circle / s		Rate of inclination angle
DEL_N	f4	1 semi-circle / s		Mean motion difference from computed value
C_uc	f4	1 rad		Amplitude of the cosine harmonic correction term to the argument of latitude
C_us	f4	1 rad		Amplitude of the sine harmonic correction term to the argument of latitude
C_rc	f4	1 m		Amplitude of the cosine harmonic correction term to the orbit radius
C_rs	f4	1 m		Amplitude of the sine harmonic correction term to the orbit radius
C_ic	f4	1 rad		Amplitude of the sine harmonic correction term to the angle of inclination
C_is	f4	1 rad		Amplitude of the cosine harmonic correction term to the angle of inclination
t_oe	u4	1 s		Reference time, ephemeris
t_oc	u4	1 s		Reference time, clock. The <i>Source</i> field indicates which clock model <i>t_oc</i> refers to.
a_f2	f4	1 s / s ²		SV clock aging. The <i>Source</i> field indicates which clock model <i>a_f2</i> refers to.
a_f1	f4	1 s / s		SV clock drift. The <i>Source</i> field indicates which clock model <i>a_f1</i> refers to.
a_f0	f8	1 s		SV clock bias. The <i>Source</i> field indicates which clock model <i>a_f0</i> refers to.
WNt_oe	u2	1 week		WN associated with <i>t_oe</i> , in GPS time frame, modulo 4096
WNt_oc	u2	1 week		WN associated with <i>t_oc</i> , in GPS time frame, modulo 4096
IODnav	u2			Issue of data, navigation (10 bits)
Health_OSSOL	u2			Bit field indicating the last received Health Status (HS) and Data Validity Status (DVS) of the E5a, E5b and L1-B signals: Bit 0: If set, bits 1 to 3 are valid, otherwise they must be ignored. Bit 1: 1-bit L1-B _{DVS} Bits 2-3: 2-bit L1-B _{HS} Bit 4: If set, bits 5 to 7 are valid, otherwise they must be ignored. Bit 5: 1-bit E5b _{DVS} Bits 6-7: 2-bit E5b _{HS} Bit 8: If set, bits 9 to 11 are valid, otherwise they must be ignored. Bit 9: 1-bit E5a _{DVS} Bits 10-11: 2-bit E5a _{HS} Bits 12-15: Reserved
Health_PRS	u1			Reserved

SISA_L1E5a	u1		255	Signal-In-Space Accuracy Index (L1, E5a)
SISA_L1E5b	u1		255	Signal-In-Space Accuracy Index (L1, E5b)
SISA_L1AE6A	u1		255	Reserved
BGD_L1E5a	f4	1 s	$-2 \cdot 10^{10}$	Last received broadcast group delay (L1, E5a)
BGD_L1E5b	f4	1 s	$-2 \cdot 10^{10}$	Last received broadcast group delay (L1, E5b)
BGD_L1AE6A	f4	1 s	$-2 \cdot 10^{10}$	Reserved
CNAVenc	u1		255	2-bit C/NAV encryption status.

GALAlm	Number:	4003	
	"OnChange" interval:	output each time a new almanac set is received for a satellite.	

The GalAlm block contains the decoded almanac data for one Galileo satellite.

Parameter	Type	Units	Do-Not-Use	Description
Sync1	c1			Block Header, see 4.1.1
Sync2	c1			
CRC	u2			
ID	u2			
Length	u2	1 byte		
TOW	u4	0.001 s	4294967295	SIS time stamp, see 4.1.3
WNc	u2	1 week	65535	
SVID	u1			SVID of the Galileo satellite from which these almanac parameters have been received (see 4.1.9)
Source	u1			See corresponding field in the GalNav block. Source can take the value 18 to indicate that the almanac data contained in this block has been merged from INAV and FNAV pages.
e	f4			Eccentricity
t_oa	u4	1 s		almanac reference time of week
delta_i	f4	1 semi-circle		Inclination angle at reference time, relative to nominal
OMEGADOT	f4	1 semi-circle / s		Rate of right ascension
SQRT_A	f4	1 m ^{1/2}		Square root of the semi-major axis, relative to nominal
OMEGA_0	f4	1 semi-circle		Longitude of ascending node of orbit plane at weekly epoch
omega	f4	1 semi-circle		Argument of perigee
M_0	f4	1 semi-circle		Mean anomaly at reference time
a_f1	f4	1 s / s		SV clock drift
a_f0	f4	1 s		SV clock bias
WN_a	u1	1 week		2-bit almanac reference week
SVID_A	u1			SVID of the Galileo satellite of which the almanac parameters are provided in this block (see 4.1.9 for the SVID numbering convention).
health	u2			Bit field indicating the health status (HS) of the E5a, E5b, L1-B, L1-A and E6-A signals: Bit 0: If set, bits 1 and 2 are valid, otherwise they must be ignored. Bits 1-2: 2-bit L1-B _{HS} Bit 3: If set, bits 4 and 5 are valid, otherwise they must be ignored. Bits 4-5: 2-bit E5b _{HS} Bit 6: If set, bits 7 and 8 are valid, otherwise they must be ignored. Bits 7-8: 2-bit E5a _{HS} Bit 9: Not applicable Bits 10-11: Not applicable Bit 12: Not applicable Bits 13-14: Not applicable Bit 15: Reserved

IODa	u1		4-bit Issue of Data for the almanac.
------	----	--	--------------------------------------

GALIon	Number: 4030
	"OnChange" interval: output each time the ionospheric parameters are received from a Galileo satellite.

The GalIon block contains the decoded ionosphere model parameters of the Galileo system.

Parameter	Type	Units	Do-Not-Use	Description
Sync1	c1			Block Header, see 4.1.1
Sync2	c1			
CRC	u2			
ID	u2			
Length	u2	1 byte		
TOW	u4	0.001 s	4294967295	SIS time stamp, see 4.1.3
WNc	u2	1 week	65535	
SVID	u1			SVID of the Galileo satellite from which these parameters have been received (see 4.1.9)
Source	u1			Message type from which the data has been decoded: 2: I/NAV 16: F/NAV
a_i0	f4	$1 \cdot 10^{-22} \text{ W} / (\text{m}^2 \text{ Hz})$		Effective ionization level, a_{i0}
a_i1	f4	$1 \cdot 10^{-22} \text{ W} / (\text{m}^2 \text{ Hz}) / \text{deg}$		Effective ionization level, a_{i1}
a_i2	f4	$1 \cdot 10^{-22} \text{ W} / (\text{m}^2 \text{ Hz}) / \text{deg}^2$		Effective ionization level, a_{i2}
StormFlags	u1			Bit field containing the five ionospheric storm flags: Bit 0: SF5 Bit 1: SF4 Bit 2: SF3 Bit 3: SF2 Bit 4: SF1 Bits 5-7: Reserved

GalU t c	Number:	4031	"OnChange" interval: output each time the UTC offset parameters are received from a Galileo satellite.
-----------------	---------	------	--

The GalU**t**c block contains the decoded UTC parameter information.

Parameter	Type	Units	Do-Not-Use	Description
Sync1	c1			Block Header, see 4.1.1
Sync2	c1			
CRC	u2			
ID	u2			
Length	u2	1 byte		
TOW	u4	0.001 s	4294967295	SIS time stamp, see 4.1.3
WNc	u2	1 week	65535	
SVID	u1			SVID of the Galileo satellite from which these parameters have been received (see 4.1.9)
Source	u1			Message type from which the data has been decoded: 2: I/NAV 16: F/NAV
A ₁	f4	1 s / s	$-2 \cdot 10^{10}$	first order term of polynomial
A ₀	f8	1 s	$-2 \cdot 10^{10}$	constant term of polynomial
t _{ot}	u4	1 s		reference time of week for UTC data
WN _{ot}	u1	1 week		UTC reference week number, to which t _{ot} is referenced
DEL _{t_LS}	i1	1 s		Delta time due to leap seconds whenever the effectivity time is not in the past
WN _{LSF}	u1	1 week		Effectivity time of leap second (week)
DN	u1	1 day		Effectivity time of leap second (day, from 1 to 7)
DEL _{t_LSF}	i1	1 s		Delta time due to leap seconds whenever the effectivity time is in the past

GALGstGps	Number:	4032	"OnChange" interval: output each time valid GST-GPS offset parameters are received from a Galileo satellite.
-----------	---------	------	--

This block contains the decoded GPS to Galileo System Time offset parameters. This block is only output if these parameters are valid in the navigation page (i.e. if they are not set to "all ones").

Parameter	Type	Units	Do-Not-Use	Description
Sync1	c1			Block Header, see 4.1.1
Sync2	c1			
CRC	u2			
ID	u2			
Length	u2	1 byte		
TOW	u4	0.001 s	4294967295	SIS time stamp, see 4.1.3
WNc	u2	1 week	65535	
SVID	u1			SVID of the Galileo satellite from which these parameters have been received (see 4.1.9)
Source	u1			Message type from which the data has been decoded: 2: I/NAV 16: F/NAV
A_1G	f4	$1 \cdot 10^9$ ns / s		Rate of change of the offset
A_0G	f4	$1 \cdot 10^9$ ns		Constant term of the offset
t_oG	u4	1 s		Reference time of week
WN_oG	u1	1 week		6-bit reference week number.

GALSARRLM	Number:	4034	"OnChange" interval: generated each time a SAR RLM message is decoded.
-----------	---------	------	--

This block contains a decoded Galileo search-and-rescue (SAR) return link message (RLM).

Parameter	Type	Units	Do-Not-Use	Description
Sync1	c1			Block Header, see 4.1.1
Sync2	c1			
CRC	u2			
ID	u2			
Length	u2	1 byte		
TOW	u4	0.001 s	4294967295	SIS time stamp, see 4.1.3
WNc	u2	1 week	65535	
SVID	u1			SVID of the Galileo satellite from which this RLM has been received.
Source	u1			Message type from which the data has been decoded: 2: I/NAV 16: F/NAV
RLMLength	u1			Length of the RLM message in bits. <i>RLMLength</i> can be either 80 for a short message or 160 for a long message.
Reserved	u1[3]			Reserved for future use, to be ignored by decoding software
RLMbits	u4[M]			Bits in the RLM message, with the first bit being the MSB of <i>RLMbits</i> [0]. <i>N</i> is 3 for a short message (i.e. if <i>RLMLength</i> is 80), and 5 for a long message (i.e. if <i>RLMLength</i> is 160). The 16 unused bits of a short message are set to 0. These bits correspond to the 16 LSBs of <i>RLMbits</i> [2].
Padding	u1[.]			Padding bytes, see 4.1.5

4.2.6 BeiDou Decoded Message Blocks

BDSNav	Number: 4081 "OnChange" interval: block generated each time a new navigation data set is received from a BeiDou satellite
--------	--

The BDSNav block contains the decoded navigation data for one BeiDou satellite, as received from the D1 or D2 nav message.

Parameter	Type	Units	Do-Not-Use	Description
Sync1	c1			Block Header, see 4.1.1
Sync2	c1			
CRC	u2			
ID	u2			
Length	u2	1 byte		
TOW	u4	0.001 s	4294967295	SIS time stamp, see 4.1.3
WNc	u2	1 week	65535	
PRN	u1			ID of the BeiDou satellite of which the ephemeris is given in this block (see 4.1.9)
Reserved	u1			Reserved for future use, to be ignored by decoding software
WN	u2	1 week		BeiDou week number as received from the navigation message (from 0 to 8191)
URA	u1			User range accuracy index (4-bit value)
SatH1	u1			1-bit autonomous health
IODC	u1			Age of data, clock (5 bits)
IODE	u1			Age of data, ephemeris (5 bits)
Reserved2	u2			unused, to be ignored by decoding software
T_GD1	f4	1 s		B1I equipment group delay differential
T_GD2	f4	1 s	$-2 \cdot 10^{10}$	B2I equipment group delay differential (set to the Do-Not-Use value when unknown)
t_oc	u4	1 s		clock data reference time, in BeiDou system time (lagging GPS time by 14 seconds).
a_f2	f4	$1 \text{ s} / \text{s}^2$		SV clock aging
a_f1	f4	$1 \text{ s} / \text{s}$		SV clock drift
a_f0	f4	1 s		SV clock bias
C_rs	f4	1 m		Amplitude of the sine harmonic correction term to the orbit radius
DEL_N	f4	1 semi-circle / s		Mean motion difference from computed value
M_0	f8	1 semi-circle		Mean anomaly at reference time
C_uc	f4	1 rad		Amplitude of the cosine harmonic correction term to the argument of latitude
e	f8			Eccentricity
C_us	f4	1 rad		Amplitude of the sine harmonic correction term to the argument of latitude
SQRT_A	f8	$1 \text{ m}^{1/2}$		Square root of the semi-major axis
t_oe	u4	1 s		Reference time ephemeris, in BeiDou system time (lagging GPS time by 14 seconds).
C_ic	f4	1 rad		Amplitude of the cosine harmonic correction term to the angle of inclination
OMEGA_0	f8	1 semi-circle		Longitude of ascending node of orbit plane at weekly epoch

C_is	f4	1 rad		Amplitude of the sine harmonic correction term to the angle of inclination
i_0	f8	1 semi-circle		Inclination angle at reference time
C_rc	f4	1 m		Amplitude of the cosine harmonic correction term to the orbit radius
omega	f8	1 semi-circle		Argument of perigee
OMEGADOT	f4	1 semi-circle / s		Rate of right ascension
IDOT	f4	1 semi-circle / s		Rate of inclination angle
WNt_oc	u2	1 week		BeiDou week number associated with t_oc, modulo 8192. Note that this value relates to the BeiDou system time.
WNt_oe	u2	1 week		BeiDou week number associated with t_oe, modulo 8192. Note that this values relates to the BeiDou system time.
Padding	u1[.]			Padding bytes, see 4.1.5

BDSA _{1m} Number:	4119
"OnChange" interval:	block generated each time a new almanac data set is received from a BeiDou satellite

The BDSA_{1m} block contains the decoded almanac data for one BeiDou satellite.

Parameter	Type	Units	Do-Not-Use	Description
Sync1	c1			Block Header, see 4.1.1
Sync2	c1			
CRC	u2			
ID	u2			
Length	u2	1 byte		
TOW	u4	0.001 s	4294967295	SIS time stamp, see 4.1.3
WNc	u2	1 week	65535	
PRN	u1			ID of the BeiDou satellite of which the almanac is given in this block (see 4.1.9)
WN _a	u1	1 week		Almanac week number
t _{oa}	u4	1 s		Almanac reference time
SQRT _A	f4	1 m ^{1/2}		Square root of the semi-major axis
e	f4			Eccentricity
omega	f4	1 semi-circle		Argument of perigee
M ₀	f4	1 semi-circle		Mean anomaly at reference time
OMEGA ₀	f4	1 semi-circle		Longitude of ascending node of orbital plane computed according to reference time
OMEGADOT	f4	1 semi-circle / s		Rate of right ascension
delta _i	f4	1 semi-circle		Correction of orbit reference inclination at reference time
a _{f0}	f4	1 s		Satellite clock bias
a _{f1}	f4	1 s / s		Satellite clock drift
Health	u2			Satellite health information (9 bits)
Reserved	u1[2]			Reserved for future use, to be ignored by decoding software
Padding	u1[.]			Padding bytes, see 4.1.5

BDSIon	Number:	4120
	"OnChange" interval:	output each time the ionospheric parameters are received from a BeiDou satellite

The BDSIon block contains the BeiDou ionosphere data (the Klobuchar coefficients), as received from the D1 or D2 nav message.

Parameter	Type	Units	Do-Not-Use	Description
Sync1	c1			Block Header, see 4.1.1
Sync2	c1			
CRC	u2			
ID	u2			
Length	u2	1 byte		
TOW	u4	0.001 s	4294967295	SIS time stamp, see 4.1.3
WNc	u2	1 week	65535	
PRN	u1			ID of the BeiDou satellite from which the coefficients have been received (see 4.1.9)
Reserved	u1			Reserved for future use, to be ignored by decoding software
alpha_0	f4	1 s		vertical delay coefficient 0
alpha_1	f4	1 s / semi-circle		vertical delay coefficient 1
alpha_2	f4	1 s / semi-circle ²		vertical delay coefficient 2
alpha_3	f4	1 s / semi-circle ³		vertical delay coefficient 3
beta_0	f4	1 s		model period coefficient 0
beta_1	f4	1 s / semi-circle		model period coefficient 1
beta_2	f4	1 s / semi-circle ²		model period coefficient 2
beta_3	f4	1 s / semi-circle ³		model period coefficient 3
Padding	u1[.]			Padding bytes, see 4.1.5

BDSUTC	Number: 4121
	"OnChange" interval: output each time the UTC offset parameters are received from a BeiDou satellite

The BDSUTC block contains the BeiDou UTC data, as received from the D1 or D2 nav message.

Note that BDT (BeiDou time) started on January 1st, 2006 (GPS week 1356). Therefore the delta time between BDT and UTC due to leap seconds is 14 less than the value in GPSUTC.

Parameter	Type	Units	Do-Not-Use	Description
Sync1	c1			Block Header, see 4.1.1
Sync2	c1			
CRC	u2			
ID	u2			
Length	u2	1 byte		
TOW	u4	0.001 s	4294967295	SIS time stamp, see 4.1.3
WNc	u2	1 week	65535	
PRN	u1			ID of the BeiDou satellite from which the coefficients have been received (see 4.1.9)
Reserved	u1			Reserved for future use, to be ignored by decoding software
A_1	f4	1 s / s		first order term of polynomial
A_0	f8	1 s		constant term of polynomial
DEL_t_LS	i1	1 s		Delta time due to leap seconds whenever the effectivity time is not in the past
WN_LSF	u1	1 week		Effectivity time of leap second (week)
DN	u1	1 day		Effectivity time of leap second (day, from 0 to 6)
DEL_t_LSF	i1	1 s		Delta time due to leap seconds whenever the effectivity time is in the past
Padding	u1[.]			Padding bytes, see 4.1.5

4.2.7 QZSS Decoded Message Blocks

QZSNav	Number: 4095
	"OnChange" interval: block generated each time a new navigation data set is received from a QZSS satellite

The QZSNav block contains the decoded navigation data for one QZSS satellite. The data is decoded from the navigation message transmitted in the L1 C/A signal. Refer to the QZSS ICD for further details.

Parameter	Type	Units	Do-Not-Use	Description
Sync1	c1			Block Header, see 4.1.1
Sync2	c1			
CRC	u2			
ID	u2			
Length	u2	1 byte		
TOW	u4	0.001 s	4294967295	SIS time stamp, see 4.1.3
WNc	u2	1 week	65535	
PRN	u1			ID of the QZSS satellite of which the ephemeris is given in this block (see 4.1.9)
Reserved	u1			Reserved for future use, to be ignored by decoding software
WN	u2	1 week	65535	Week number (10 bits from subframe 1, word 3)
CAorPonL2	u1			Code(s) on L2 channel (2 bits from subframe 1, word 3). Always 2 for QZSS satellites.
URA	u1			User Range accuracy index (4 bits from subframe 1 word 3)
health	u1			6-bit health from subframe 1, word 3 (6 bits from subframe 1, word 3)
L2DataFlag	u1			Data flag for L2 P-code (1 bit from subframe 1, word 4). Always 1 for QZSS satellites.
IODC	u2			Issue of data, clock (10 bits from subframe 1)
IODE2	u1			Issue of data, ephemeris (8 bits from subframe 2)
IODE3	u1			Issue of data, ephemeris (8 bits from subframe 3)
FitIntFlg	u1			Curve Fit Interval, (1 bit from subframe 2, word 10)
Reserved2	u1			unused, to be ignored by decoding software
T_gd	f4	1 s	$-2 \cdot 10^{10}$	Estimated group delay differential
t_oc	u4	1 s		clock data reference time
a_f2	f4	$1 \text{ s} / \text{s}^2$		SV clock aging
a_f1	f4	$1 \text{ s} / \text{s}$		SV clock drift
a_f0	f4	1 s		SV clock bias
C_rs	f4	1 m		Amplitude of the sine harmonic correction term to the orbit radius
DEL_N	f4	1 semi-circle / s		Mean motion difference from computed value
M_0	f8	1 semi-circle		Mean anomaly at reference time
C_uc	f4	1 rad		Amplitude of the cosine harmonic correction term to the argument of latitude
e	f8			Eccentricity
C_us	f4	1 rad		Amplitude of the sine harmonic correction term to the argument of latitude
SQRT_A	f8	$1 \text{ m}^{1/2}$		Square root of the semi-major axis

t_oe	u4	1 s		Reference time ephemeris
C_ic	f4	1 rad		Amplitude of the cosine harmonic correction term to the angle of inclination
OMEGA_0	f8	1 semi-circle		Longitude of ascending node of orbit plane at weekly epoch
C_is	f4	1 rad		Amplitude of the sine harmonic correction term to the angle of inclination
i_0	f8	1 semi-circle		Inclination angle at reference time
C_rc	f4	1 m		Amplitude of the cosine harmonic correction term to the orbit radius
omega	f8	1 semi-circle		Argument of perigee
OMEGADOT	f4	1 semi-circle / s		Rate of right ascension
IDOT	f4	1 semi-circle / s		Rate of inclination angle
WNt_oc	u2	1 week		WN associated with t_oc, modulo 1024
WNt_oe	u2	1 week		WN associated with t_oe, modulo 1024
Padding	u1[.]			Padding bytes, see 4.1.5

QZSA1m	Number:	4116
	"OnChange" interval:	block generated each time a new almanac data set is received from a QZSS satellite

The QZSA1m block contains the decoded almanac data for one QZSS satellite. These data are conveyed in subframes 4 and 5 of the satellite navigation message. Refer to QZSS ICD for further details.

Parameter	Type	Units	Do-Not-Use	Description
Sync1	c1			Block Header, see 4.1.1
Sync2	c1			
CRC	u2			
ID	u2			
Length	u2	1 byte		
TOW	u4	0.001 s	4294967295	SIS time stamp, see 4.1.3
WNc	u2	1 week	65535	
PRN	u1			ID of the QZSS satellite of which the almanac is given in this block (see 4.1.9)
Reserved	u1			Reserved for future use, to be ignored by decoding software
e	f4			Difference from reference eccentricity
t_oa	u4	1 s		almanac reference time of week
delta_i	f4	1 semi-circle		Difference from reference angle of inclination
OMEGADOT	f4	1 semi-circle / s		Rate of right ascension
SQRT_A	f4	1 m ^{1/2}		Square root of the semi-major axis
OMEGA_0	f4	1 semi-circle		Longitude of ascending node of orbit plane at weekly epoch
omega	f4	1 semi-circle		Argument of perigee
M_0	f4	1 semi-circle		Mean anomaly at reference time
a_f1	f4	1 s / s		SV clock drift
a_f0	f4	1 s		SV clock bias
WN_a	u1	1 week		Almanac reference week, to which t_oa is referenced
Reserved2	u1			Reserved for future use, to be ignored by decoding software
health8	u1			health on 8 bits from the almanac page
health6	u1			health summary on 6 bits (from subframe 4, page 25 and subframe 5 page 25)
Padding	u1[.]			Padding bytes, see 4.1.5

4.2.8 SBAS L1 Decoded Message Blocks

GEOMT00	Number: 5925 "OnChange" interval: block generated each time an empty MT00 is received from an SBAS satellite on the L1 signal
---------	--

This block is sent to indicate that an empty SBAS message type 0 has been received.

Depending on the SBAS operational mode, message type 0 can contain the contents of message type 2. Upon reception of a message type 0, the receiver checks whether the message is empty (it contains only 0's) or whether it contains the message type 2 contents. In the former case, a `GEOMT00` block will be generated. In the latter case, a `GEOFastCorr` block will be generated. Refer to section A.4.4.1 of the DO 229 standard for further details.

Parameter	Type	Units	Do-Not-Use	Description
Sync1	c1			Block Header, see 4.1.1
Sync2	c1			
CRC	u2			
ID	u2			
Length	u2	1 byte		
TOW	u4	0.001 s	4294967295	SIS time stamp, see 4.1.3
WNc	u2	1 week	65535	
PRN	u1			ID of the SBAS satellite from which the message has been received (see 4.1.9)

GEOPRNMask	Number: 5926 "OnChange" interval: block generated each time MT01 is received from an SBAS satellite
------------	--

This block contains the decoded PRN mask transmitted in SBAS message type 1. Refer to section A.4.4.2 of the DO 229 standard for further details.

Parameter	Type	Units	Do-Not-Use	Description
Sync1	c1			Block Header, see 4.1.1
Sync2	c1			
CRC	u2			
ID	u2			
Length	u2	1 byte		
TOW	u4	0.001 s	4294967295	SIS time stamp, see 4.1.3
WNc	u2	1 week	65535	
PRN	u1			ID of the SBAS satellite from which the message has been received (see 4.1.9)
IODP	u1			Issue of data - PRN.
NbrPRNs	u1			Number of PRNs designated in the mask.
PRNMask	u1[NbrPRNs]			List of the PRNs in the PRN mask. PRNMask[0] is the first PRN designated in the PRN mask (from 1 to 210), PRNMask[1] is the 2 nd PRN designated in the PRN mask, etc...
Padding	u1[..]			Padding bytes, see 4.1.5

GEOFastCorr	Number: 5927 "OnChange" interval: block generated each time MT02, MT03, MT04, MT05, MT24 and possibly MT00 is received from an SBAS satellite
-------------	--

This block contains the decoded fast corrections transmitted in the SBAS message types 2, 3, 4, 5, 24 and possibly 0 if the type 0 message contains the type 2 contents. Refer to section A.4.4.3 and A.4.4.8 of the DO 229 standard for further details.

Parameter	Type	Units	Do-Not-Use	Description								
Sync1	c1			Block Header, see 4.1.1								
Sync2	c1											
CRC	u2											
ID	u2											
Length	u2	1 byte										
TOW	u4	0.001 s	4294967295	SIS time stamp, see 4.1.3								
WNc	u2	1 week	65535									
PRN	u1			ID of the SBAS satellite from which the message has been received (see 4.1.9)								
MT	u1			Message type from which these fast corrections come, either 0, 2, 3, 4, 5 or 24.								
IODP	u1			Issue of data - PRN.								
IODF	u1			Issue of data - fast corrections.								
N	u1			Number of fast correction sets in this message. This is the number of <i>FastCorr</i> sub-blocks. <i>N</i> depends on the message type as follows. <table border="1" style="margin-left: auto; margin-right: auto;"> <thead> <tr> <th>Message type</th> <th>N</th> </tr> </thead> <tbody> <tr> <td>MT00, MT02, MT03, MT04</td> <td>13</td> </tr> <tr> <td>MT05</td> <td>12</td> </tr> <tr> <td>MT24</td> <td>6</td> </tr> </tbody> </table>	Message type	N	MT00, MT02, MT03, MT04	13	MT05	12	MT24	6
Message type	N											
MT00, MT02, MT03, MT04	13											
MT05	12											
MT24	6											
SBLength	u1			Length of the <i>FastCorr</i> sub-blocks in bytes								
<i>FastCorr</i>		A succession of <i>N</i> <i>FastCorr</i> sub-blocks, see definition below								
Padding	u1[.]			Padding bytes, see 4.1.5								

FastCorr sub-block definition:

Parameter	Type	Units	Description
PRNMaskNo	u1		Sequence number in the PRN mask. This field may be set to zero. In that case, all following fields in this sub-block must be discarded.
UDREI	u1		User Differential Range Error Indicator for the PRN at index <i>PRNMaskNo</i> .
Reserved	u1[2]		Reserved for future use, to be ignored by decoding software
PRC	f4	1 m	Pseudorange correction for the PRN at index <i>PRNMaskNo</i> .
Padding	u1[.]		Padding bytes, see 4.1.5

GEOIntegrity	Number:	5928	
	"OnChange" interval:	block generated each time MT06 is received from an SBAS satellite	

This block contains the decoded integrity information transmitted in SBAS message type 6. Refer to section A.4.4.4 of the DO-229 standard for further details.

Parameter	Type	Units	Do-Not-Use	Description
Sync1	c1			Block Header, see 4.1.1
Sync2	c1			
CRC	u2			
ID	u2			
Length	u2	1 byte		
TOW	u4	0.001 s	4294967295	SIS time stamp, see 4.1.3
WNc	u2	1 week	65535	
PRN	u1			ID of the SBAS satellite from which the message has been received (see 4.1.9)
Reserved	u1			Reserved for future use, to be ignored by decoding software
IODF	u1[4]			Issue of data - fast corrections for MT02, MT03, MT04 and MT05.
UDREI	u1[51]			User Differential Range Error Indicator for each of the 51 slots in the PRN mask.

GEOFastCorrDegr	Number: 5929 "OnChange" interval: block generated each time MT07 is received from an SBAS satellite
-----------------	--

This block contains the decoded fast correction degradation factors transmitted in SBAS message type 7. Refer to section A.4.4.5 of the DO-229 standard for further details.

Parameter	Type	Units	Do-Not-Use	Description
Sync1	c1			Block Header, see 4.1.1
Sync2	c1			
CRC	u2			
ID	u2			
Length	u2	1 byte		
TOW	u4	0.001 s	4294967295	SIS time stamp, see 4.1.3
WNc	u2	1 week	65535	
PRN	u1			ID of the SBAS satellite from which the message has been received (see 4.1.9)
IODP	u1			Issue of data - PRN.
t_lat	u1	1 s		System latency.
ai	u1[51]			Degradation factor indicator (from 0 to 15) for each of the 51 slots in the PRN mask.
Padding	u1[.]			Padding bytes, see 4.1.5

GEONav	Number: 5896
	"OnChange" interval: block generated each time MT09 is received from an SBAS satellite

This block contains the decoded navigation data transmitted in SBAS message type 9. Refer to section A.4.4.11 of the DO-229 standard for further details.

Parameter	Type	Units	Do-Not-Use	Description
Sync1	c1			Block Header, see 4.1.1
Sync2	c1			
CRC	u2			
ID	u2			
Length	u2	1 byte		
TOW	u4	0.001 s	4294967295	SIS time stamp, see 4.1.3
WNc	u2	1 week	65535	
PRN	u1			ID of the SBAS satellite of which the navigation data is provided here (see 4.1.9)
Reserved	u1			Reserved for future use, to be ignored by decoding software
IODN	u2			Issue of data - navigation (DO 229-B) Spare (DO 229-C)
URA	u2			Accuracy exponent
t ₀	u4	1 s		Time of applicability (time-of-day)
X _g	f8	1 m		X position at time-of-day t ₀
Y _g	f8	1 m		Y position at time-of-day t ₀
Z _g	f8	1 m		Z position at time-of-day t ₀
X _{gd}	f8	1 m / s		X velocity at time-of-day t ₀
Y _{gd}	f8	1 m / s		Y velocity at time-of-day t ₀
Z _{gd}	f8	1 m / s		Z velocity at time-of-day t ₀
X _{gdd}	f8	1 m / s ²		X acceleration at time-of-day t ₀
Y _{gdd}	f8	1 m / s ²		Y acceleration at time-of-day t ₀
Z _{gdd}	f8	1 m / s ²		Z acceleration at time-of-day t ₀
aGf0	f4	1 s		Time offset with respect to SBAS network time
aGf1	f4	1 s / s		Time drift with respect to SBAS network time
Padding	u1[.]			Padding bytes, see 4.1.5

GEODegrFactors	Number:	5930
	"OnChange" interval:	block generated each time MT10 is received from an SBAS satellite

This block contains the decoded degradation factors transmitted in SBAS message type 10. Refer to section A.4.5 of the DO-229 standard for further details.

Parameter	Type	Units	Do-Not-Use	Description
Sync1	c1			Block Header, see 4.1.1
Sync2	c1			
CRC	u2			
ID	u2			
Length	u2	1 byte		
TOW	u4	0.001 s	4294967295	SIS time stamp, see 4.1.3
WNc	u2	1 week	65535	
PRN	u1			ID of the SBAS satellite from which the message has been received (see 4.1.9)
Reserved	u1			Reserved for future use, to be ignored by decoding software
Brrc	f8	1 m		A parameter associated with the relative estimation noise and round-off error.
Cltc_lsb	f8	1 m		Maximum round-off error due to the LSB resolution of the orbit and clock information.
Cltc_v1	f8	1 m / s		Velocity error bound on the maximum range rate difference of missed messages due to clock and orbit rate differences.
Iltc_v1	u4	1 s		Update interval for long term corrections when the velocity code is 1.
Cltc_v0	f8	1 m		Bound on the update delta between successive long term corrections.
Iltc_v0	u4	1 s		Minimum update interval for long term messages when the velocity code is 0.
Cgeo_lsb	f8	1 m		Maximum round-off error due to the LSB resolution of the orbit and clock information.
Cgeo_v	f8	1 m / s		Velocity error bound on the maximum range rate difference of missed messages due to clock and orbit rate differences.
Igeo	u4	1 s		Update interval for GEO navigation messages.
Cer	f4	1 m		A degradation parameter.
Ciono_step	f8	1 m		Bound on the difference between successive ionospheric grid delay values.
Iiono	u4	1 s		Minimum update interval for ionospheric correction messages.
Ciono_ramp	f8	1 m / s		Rate of change of the ionospheric corrections.
RSSudre	u1			Root-sum-square flag (UDRE)
RSSiono	u1			Root-sum-square flag (IONO)
Reserved2	u1[2]			Reserved for future use, to be ignored by decoding software
Ccovariance	f8			A parameter used to compensate for the errors introduced by quantization (introduced in DO 229-C). To be multiplied by the SF parameter from the GEOClockEphCovMatrix block.
Padding	u1[.]			Padding bytes, see 4.1.5

GEONetworkTime	Number: 5918 "OnChange" interval: block generated each time MT12 is received from an SBAS satellite
----------------	--

This block contains the decoded network time offset parameters transmitted in SBAS message type 12. Refer to section A.4.4.15 of the DO-229 standard for further details.

Parameter	Type	Units	Do-Not-Use	Description
Sync1	c1			Block Header, see 4.1.1
Sync2	c1			
CRC	u2			
ID	u2			
Length	u2	1 byte		
TOW	u4	0.001 s	4294967295	SIS time stamp, see 4.1.3
WNc	u2	1 week	65535	
PRN	u1			ID of the SBAS satellite from which this Network Time data was received (see 4.1.9)
Reserved	u1			Reserved for future use, to be ignored by decoding software
A_1	f4	1 s / s		first order term of polynomial
A_0	f8	1 s		constant term of polynomial
t_ot	u4	1 s		reference time for UTC data (time of week)
WN_t	u1	1 week		UTC reference week number, to which t_ot is referenced
DEL_t_LS	i1	1 s		Delta time due to leap seconds whenever the effectivity time is not in the past
WN_LSF	u1	1 week		Effectivity time of leap second (week)
DN	u1	1 day		Effectivity time of leap second (day)
DEL_t_LSF	i1	1 s		Delta time due to leap seconds whenever the effectivity time is in the past
UTC_std	u1			UTC Standard Identifier
GPS_WN	u2	1 week		GPS week number (modulo 1024)
GPS_TOW	u4	1 s		GPS time-of-week
GlonassID	u1			Glonass Indicator
Padding	u1[.]			Padding bytes, see 4.1.5

GEOAlm	Number:	5897	"OnChange" interval: block generated each time MT17 is received from an SBAS satellite
--------	---------	------	--

This block contains the decoded almanac data for one SBAS satellite, as transmitted in SBAS message type 17. A different GEOAlm block is generated for each of the up to three almanac data sets in MT17. Refer to section A.4.4.12 of the DO-229 standard for further details.

Parameter	Type	Units	Do-Not-Use	Description
Sync1	c1			Block Header, see 4.1.1
Sync2	c1			
CRC	u2			
ID	u2			
Length	u2	1 byte		
TOW	u4	0.001 s	4294967295	SIS time stamp, see 4.1.3
WNc	u2	1 week	65535	
PRN	u1			ID of the SBAS satellite of which the almanac is provided here (see 4.1.9)
Reserved0	u1			Reserved for future use, to be ignored by decoding software
DataID	u1			Data ID
Reserved1	u1			Reserved for future use, to be ignored by decoding software
Health	u2			Health bits
t_oa	u4	1 s		Time of applicability with the day ambiguity resolved. This is the time in GPS seconds from Jan 6th, 1980.
Xg	f8	1 m		X position at t_oa
Yg	f8	1 m		Y position at t_oa
Zg	f8	1 m		Z position at t_oa
Xgd	f8	1 m / s		X velocity at t_oa
Ygd	f8	1 m / s		Y velocity at t_oa
Zgd	f8	1 m / s		Z velocity at t_oa
Padding	u1[.]			Padding bytes, see 4.1.5

GEOIGPMask	Number: 5931 "OnChange" interval: block generated each time MT18 is received from an SBAS satellite
------------	--

This block contains the decoded ionospheric grid point mask transmitted in SBAS message type 18. Refer to section A.4.4.9 of the DO-229 standard for further details.

Parameter	Type	Units	Do-Not-Use	Description
Sync1	c1			Block Header, see 4.1.1
Sync2	c1			
CRC	u2			
ID	u2			
Length	u2	1 byte		
TOW	u4	0.001 s	4294967295	SIS time stamp, see 4.1.3
WNc	u2	1 week	65535	
PRN	u1			ID of the SBAS satellite from which the message has been received (see 4.1.9)
NbrBands	u1			Number of bands being broadcast.
BandNbr	u1			Band number.
IODI	u1			Issue of data - ionosphere.
NbrIGPs	u1			Number of ionospheric grid points (IGP) designated in the mask.
IGPMask	u1[NbrIGPs]			List of the IGPs in the IGP mask. IGPMask [0] is the first IGP designated in the IGP mask (from 1 to 201), IGPMask [1] is the 2 nd IGP designated in the IGP mask, etc...
Padding	u1[..]			Padding bytes, see 4.1.5

GEOLongTermCorr	Number:	5932
	"OnChange" interval:	block generated each time MT24 or MT25 is received from an SBAS satellite

This block contains the decoded long term corrections transmitted in SBAS message types 24 and 25. Refer to section A.4.4.7 and A.4.4.8 of the DO-229 standard for further details.

Parameter	Type	Units	Do-Not-Use	Description
Sync1	c1			Block Header, see 4.1.1
Sync2	c1			
CRC	u2			
ID	u2			
Length	u2	1 byte		
TOW	u4	0.001 s	4294967295	SIS time stamp, see 4.1.3
WNc	u2	1 week	65535	
PRN	u1			ID of the SBAS satellite from which the message has been received (see 4.1.9)
N	u1			Number of long-term corrections in this message. This is the number of LTCorr sub-blocks. N can be 0, 1, 2, 3 or 4.
SBLength	u1	1 byte		Length of the LTCorr sub-blocks in bytes
Reserved	u1[3]			Reserved for future use, to be ignored by decoding software
LTCorr		A succession of N LTCorr sub-blocks, see definition below
Padding	u1[.]			Padding bytes, see 4.1.5

LTCorr sub-block definition:

Parameter	Type	Units	Description
VelocityCode	u1		Velocity code (0 or 1)
PRNMaskNo	u1		Sequence in the PRN mask, from 1 to 51. Note that if the PRN mask No. from the original message is 0, the corresponding long term corrections are ignored, and hence not included in the GEOLongTermCorr block.
IODP	u1		Issue of data - PRN.
IODE	u1		Issue of data - ephemeris.
dx	f4	1 m	Satellite position offset (x).
dy	f4	1 m	Satellite position offset (y).
dz	f4	1 m	Satellite position offset (z).
dxRate	f4	1 m / s	Satellite velocity offset (x), or 0.0 if VelocityCode is 0.
dyRate	f4	1 m / s	Satellite velocity offset (y), or 0.0 if VelocityCode is 0.
dzRate	f4	1 m / s	Satellite velocity offset (z), or 0.0 if VelocityCode is 0.
da_f0	f4	1 s	Satellite clock offset.
da_f1	f4	1 s / s	Satellite drift correction, or 0.0 if VelocityCode is 0.
t_oe	u4	1 s	Time-of-day of applicability, or 0 if VelocityCode is 0.
Padding	u1[.]		Padding bytes, see 4.1.5

GEOIonoDelay	Number:	5933	
	"OnChange" interval:	block generated each time MT26 is received from an SBAS satellite	

This block contains the decoded ionospheric delays transmitted in SBAS message type 26. Refer to section A.4.4.10 of the DO-229 standard for further details.

Parameter	Type	Units	Do-Not-Use	Description
Sync1	c1			Block Header, see 4.1.1
Sync2	c1			
CRC	u2			
ID	u2			
Length	u2	1 byte		
TOW	u4	0.001 s	4294967295	SIS time stamp, see 4.1.3
WNc	u2	1 week	65535	
PRN	u1			ID of the SBAS satellite from which the message has been received (see 4.1.9)
BandNbr	u1			Band number
IODI	u1			Issue of data - ionosphere.
N	u1			Number of ionospheric delay corrections in this message. This is the number of IDC sub-blocks. N is always 15.
SBLength	u1	1 byte		Length of the IDC sub-blocks in bytes.
Reserved	u1			Reserved for future use, to be ignored by decoding software
IDC		A succession of N IDC sub-blocks, see definition below
Padding	u1[.]			Padding bytes, see 4.1.5

IDC sub-block definition:

Parameter	Type	Units	Description
IGPMaskNo	u1		Sequence number in the IGP mask (see GEOIGPMask block), from 1 to 201.
GIVEI	u1		Grid Ionospheric Vertical Error Indicator, from 0 to 15
Reserved	u1[2]		Reserved for future use, to be ignored by decoding software
VerticalDelay	f4	1 m	IGP vertical delay estimate.
Padding	u1[.]		Padding bytes, see 4.1.5

GEOServiceLevel	Number: 5917
	"OnChange" interval: block generated each time MT27 is received from an SBAS satellite

This block contains a decoded service level message for a geostationary SBAS satellite as sent in message type 27. Refer to section A.4.4.13 of the DO-229 standard for further details.

Parameter	Type	Units	Do-Not-Use	Description
Sync1	c1			Block Header, see 4.1.1
Sync2	c1			
CRC	u2			
ID	u2			
Length	u2	1 byte		
TOW	u4	0.001 s	4294967295	SIS time stamp, see 4.1.3
WNc	u2	1 week	65535	
PRN	u1			ID of the SBAS satellite from which this service level message was received (see 4.1.9)
Reserved	u1			Reserved for future use, to be ignored by decoding software
IODS	u1			Issue of Data Service level, ranging from 0 to 7
nrMessages	u1			Number of service messages (MT27), from 1 to 8
MessageNR	u1			Service message number, from 1 to 8
PriorityCode	u1			Priority Code, from 0 to 3
dUDREI_In	u1			δ UDRE Indicator for users inside the service region, from 0 to 15
dUDREI_Out	u1			δ UDRE Indicator for users outside the service region, from 0 to 15
N	u1			Number of Regions in this message. This is the number of ServiceRegion sub-blocks. Ranging from 0 to 7
SBLength	u1	1 byte		Length of the ServiceRegion sub-blocks in bytes
<i>Regions</i>		<i>A succession of N ServiceRegion sub-blocks, see definition below</i>
Padding	u1[...]			Padding bytes, see 4.1.5

ServiceRegion sub-block definition:

Parameter	Type	Units	Description
Latitude1	i1	1 degree	Coordinate 1 latitude, from -90 to +90
Latitude2	i1	1 degree	Coordinate 2 latitude, from -90 to +90
Longitude1	i2	1 degree	Coordinate 1 longitude, from -180 to +180
Longitude2	i2	1 degree	Coordinate 2 longitude, from -180 to +180
RegionShape	u1		Region Shape: 0=triangular, 1=square
Padding	u1[...]		Padding bytes, see 4.1.5

GEOClockEphCovMatrix	Number: 5934 "OnChange" interval: block generated each time MT28 is received from an SBAS satellite
----------------------	--

This block contains the decoded clock-ephemeris covariance Cholesky factor matrix transmitted in SBAS message type 28. Refer to section A.4.4.16 of the DO-229 standard for further details.

Parameter	Type	Units	Do-Not-Use	Description
Sync1	c1			Block Header, see 4.1.1
Sync2	c1			
CRC	u2			
ID	u2			
Length	u2	1 byte		
TOW	u4	0.001 s	4294967295	SIS time stamp, see 4.1.3
WNc	u2	1 week	65535	
PRN	u1			Satellite ID, see 4.1.9
IODP	u1			Issue of data - PRN.
N	u1			Number of covariance matrices in this message. This is the number of CovMatrix sub-blocks. N can be 1 or 2.
SBLength	u1	1 byte		Length of the CovMatrix sub-blocks in bytes
Reserved	u1[2]			Reserved for future use, to be ignored by decoding software
CovMatrix		A succession of N CovMatrix sub-blocks, see definition below
Padding	u1[.]			Padding bytes, see 4.1.5

CovMatrix sub-block definition:

Parameter	Type	Units	Description
PRNMaskNo	u1		Sequence number in the PRN mask, from 1 to 51. Note that if the PRN mask No. from the original message is 0, the corresponding matrix is ignored, and hence not included in the GEOClockEphCovMatrix block.
Reserved	u1[2]		Reserved for future use, to be ignored by decoding software
ScaleExp	u1		Scale exponent; scale factor ($= 2^{(\text{scale exponent} - 5)}$)
E11	u2		$E_{1,1}$
E22	u2		$E_{2,2}$
E33	u2		$E_{3,3}$
E44	u2		$E_{4,4}$
E12	i2		$E_{1,2}$
E13	i2		$E_{1,3}$
E14	i2		$E_{1,4}$
E23	i2		$E_{2,3}$
E24	i2		$E_{2,4}$
E34	i2		$E_{3,4}$
Padding	u1[.]		Padding bytes, see 4.1.5

4.2.9 Position, Velocity and Time Blocks

PVTCartesian	Number: 4006
	"OnChange" interval: default PVT output rate (see 4.1.8)

This block contains the position, velocity and time (PVT) solution at the time specified in the `TOW` and `WNc` fields. The time of applicability is specified in the receiver time frame.

The computed position (x, y, z) and velocity (v_x, v_y, v_z) are reported in a Cartesian coordinate system using the datum indicated in the `Datum` field. The position is that of the marker. The ARP-to-marker offset is set through the command **setAntennaOffset**.

The PVT solution is also available in ellipsoidal form in the `PVTGeodetic` block.

The variance-covariance information associated with the reported PVT solution can be found in the `PosCovCartesian` and `VelCovCartesian` blocks.

If no PVT solution is available, the `Error` field indicates the cause of the unavailability and all fields after the `Error` field are set to their respective Do-Not-Use values.

Parameter	Type	Units	Do-Not-Use	Description
Sync1	c1			Block Header, see 4.1.1
Sync2	c1			
CRC	u2			
ID	u2			
Length	u2	1 byte		
TOW	u4	0.001 s	4294967295	Receiver time stamp, see 4.1.3
WNc	u2	1 week	65535	
Mode	u1			<p>Bit field indicating the PVT mode, as follows:</p> <p>Bits 0-3: type of PVT solution:</p> <ul style="list-style-type: none"> 0: No PVT available (the <code>ERROR</code> field indicates the cause of the absence of the PVT solution) 1: Stand-Alone PVT 2: Differential PVT 3: Fixed location 4: RTK with fixed ambiguities 5: RTK with float ambiguities 6: SBAS aided PVT 7: moving-base RTK with fixed ambiguities 8: moving-base RTK with float ambiguities 10: Precise Point Positioning (PPP) 12: Reserved <p>Bits 4-5: Reserved</p> <p>Bit 6: Set if the user has entered the command <code>setPVTMode, Static, auto</code> and the receiver is still in the process of determining its fixed position.</p> <p>Bit 7: 2D/3D flag: set in 2D mode (height assumed constant and not computed).</p>
Error	u1			<p>PVT error code. The following values are defined:</p> <ul style="list-style-type: none"> 0: No Error 1: Not enough measurements 2: Not enough ephemerides available 3: DOP too large (larger than 15) 4: Sum of squared residuals too large 5: No convergence 6: Not enough measurements after outlier rejection 7: Position output prohibited due to export laws 8: Not enough differential corrections available 9: Base station coordinates unavailable 10: Ambiguities not fixed and user requested to only output RTK-fixed positions
X	f8	1 m	$-2 \cdot 10^{10}$	X coordinate in coordinate frame specified by <code>Datum</code>
Y	f8	1 m	$-2 \cdot 10^{10}$	Y coordinate in coordinate frame specified by <code>Datum</code>
Z	f8	1 m	$-2 \cdot 10^{10}$	Z coordinate in coordinate frame specified by <code>Datum</code>
Undulation	f4	1 m	$-2 \cdot 10^{10}$	Geoid undulation. See the <code>setGeoidUndulation</code> command.
Vx	f4	1 m / s	$-2 \cdot 10^{10}$	Velocity in the X direction
Vy	f4	1 m / s	$-2 \cdot 10^{10}$	Velocity in the Y direction
Vz	f4	1 m / s	$-2 \cdot 10^{10}$	Velocity in the Z direction

COG	f4	1 degree	$-2 \cdot 10^{10}$	Course over ground: this is defined as the angle of the vehicle with respect to the local level North, ranging from 0 to 360, and increasing towards east. Set to the Do-Not-Use value when the speed is lower than 0.1m/s.
RxClkBias	f8	1 ms	$-2 \cdot 10^{10}$	Receiver clock bias relative to the GNSS system time reported in the <code>TimeSystem</code> field. Positive when the receiver time is ahead of the system time. To transfer the receiver time to the system time, use: $t_{GPS/GST} = t_{rx} - RxClkBias$
RxClkDrift	f4	1 ppm	$-2 \cdot 10^{10}$	Receiver clock drift relative to the GNSS system time (relative frequency error). Positive when the receiver clock runs faster than the system time.
TimeSystem	u1		255	Time system of which the offset is provided in this sub-block: 0: GPS time 1: Galileo time 3: GLONASS time 4: BeiDou time
Datum	u1		255	This field defines in which datum the coordinates are expressed: 0: WGS84/ITRS 19: Datum equal to that used by the DGNSS/RTK base station 30: ETRS89 (ETRF2000 realization) 31: NAD83(2011), North American Datum (2011) 32: NAD83(PA11), North American Datum, Pacific plate (2011) 33: NAD83(MA11), North American Datum, Marianas plate (2011) 34: GDA94(2010), Geocentric Datum of Australia (2010) 35: GDA2020, Geocentric Datum of Australia 2020 250: First user-defined datum 251: Second user-defined datum
NrSV	u1		255	Total number of satellites used in the PVT computation.
WACorrInfo	u1		0	Bit field providing information about which wide area corrections have been applied: Bit 0: set if orbit and satellite clock correction information is used Bit 1: set if range correction information is used Bit 2: set if ionospheric information is used Bit 3: set if orbit accuracy information is used (UERE/SISA) Bit 4: set if DO229 Precision Approach mode is active Bits 5-7: Reserved
ReferenceID	u2		65535	This field indicates the reference ID of the differential information used. In case of DGPS or RTK operation, this field is to be interpreted as the base station identifier. In SBAS operation, this field is to be interpreted as the PRN of the geostationary satellite used (from 120 to 158). If multiple base stations or multiple geostationary satellites are used the value is set to 65534.
MeanCorrAge	u2	0.01 s	65535	In case of DGPS or RTK, this field is the mean age of the differential corrections. In case of SBAS operation, this field is the mean age of the 'fast corrections' provided by the SBAS satellites.
SignalInfo	u4		0	Bit field indicating the type of GNSS signals having been used in the PVT computations. If a bit i is set, the signal type having index i has been used. The signal numbers are listed in section 4.1.10. Bit 0 (GPS-C/A) is the LSB of <code>SignalInfo</code> .

Rev 1

AlertFlag	u1		0	Bit field indicating integrity related information: Bits 0-1: RAIM integrity flag: 0: RAIM not active (integrity not monitored) 1: RAIM integrity test successful 2: RAIM integrity test failed 3: Reserved Bit 2: set if integrity has failed as per Galileo HPCA (HMI Probability Computation Algorithm) Bit 3: set if Galileo ionospheric storm flag is active Bit 4: Reserved Bits 5-7: Reserved
NrBases	u1		0	Number of base stations used in the PVT computation.
PPPInfo	u2	1 s	0	Bit field containing PPP-related information: Bits 0-11: Age of the last seed, in seconds. The age is clipped to 4091s. This field must be ignored when the seed type is 0 (see bits 13-15 below). Bit 12: Reserved Bits 13-15: Type of last seed: 0: Not seeded or not in PPP positioning mode 1: Manual seed 2: Seeded from DGPS 3: Seeded from RTKFixed
Latency	u2	0.0001 s	65535	Time elapsed between the time of applicability of the position fix and the generation of this SBF block by the receiver. This time includes the receiver processing time, but not the communication latency.
HAccuracy	u2	0.01 m	65535	2DRMS horizontal accuracy: twice the root-mean-square of the horizontal distance error. The horizontal distance between the true position and the computed position is expected to be lower than $H_{Accuracy}$ with a probability of at least 95%. The value is clipped to $65534 = 655.34m$
VAccuracy	u2	0.01 m	65535	2-sigma vertical accuracy. The vertical distance between the true position and the computed position is expected to be lower than $V_{Accuracy}$ with a probability of at least 95%. The value is clipped to $65534 = 655.34m$.
Misc	u1			Bit field containing miscellaneous flags: Bit 0: In DGNSS or RTK mode, set if the baseline points to the base station ARP. Unset if it points to the antenna phase center, or if unknown. Bit 1: Set if the phase center offset is compensated for at the rover, unset if not or unknown. Bit 2: Proprietary. Bit 3: Proprietary. Bits 4-5: Proprietary. Bits 6-7: Flag indicating whether the marker position reported in this block is also the ARP position (i.e. whether the ARP-to-marker offset provided with the <code>setAntennaOffset</code> command is zero or not) 0: Unknown 1: The ARP-to-marker offset is zero 2: The ARP-to-marker offset is not zero
Padding	u1[.]			Padding bytes, see 4.1.5

Rev 2

PVTGeodetic	Number: 4007
	"OnChange" interval: default PVT output rate (see 4.1.8)

This block contains the position, velocity and time (PVT) solution at the time specified in the `TOW` and `WNc` fields. The time of applicability is specified in the receiver time frame.

The computed position (ϕ, λ, h) and velocity (v_n, v_e, v_u) are reported in an ellipsoidal coordinate system using the datum indicated in the `Datum` field. The velocity vector is expressed relative to the local-level Cartesian coordinate frame with north-, east-, up-unit vectors. The position is that of the marker. The ARP-to-marker offset is set through the command **setAntennaOffset**.

The PVT solution is also available in Cartesian form in the `PVTCartesian` block.

The variance-covariance information associated with the reported PVT solution can be found in the `PosCovGeodetic` and `VelCovGeodetic` blocks.

If no PVT solution is available, the `Error` field indicates the cause of the unavailability and all fields after the `Error` field are set to their respective Do-Not-Use values.

Parameter	Type	Units	Do-Not-Use	Description
Sync1	c1			Block Header, see 4.1.1
Sync2	c1			
CRC	u2			
ID	u2			
Length	u2	1 byte		
TOW	u4	0.001 s	4294967295	Receiver time stamp, see 4.1.3
WNc	u2	1 week	65535	
Mode	u1			Bit field indicating the PVT mode, as follows: Bits 0-3: type of PVT solution: 0: No PVT available (the <code>ERROR</code> field indicates the cause of the absence of the PVT solution) 1: Stand-Alone PVT 2: Differential PVT 3: Fixed location 4: RTK with fixed ambiguities 5: RTK with float ambiguities 6: SBAS aided PVT 7: moving-base RTK with fixed ambiguities 8: moving-base RTK with float ambiguities 10: Precise Point Positioning (PPP) 12: Reserved Bits 4-5: Reserved Bit 6: Set if the user has entered the command <code>setPVTMode, Static, auto</code> and the receiver is still in the process of determining its fixed position. Bit 7: 2D/3D flag: set in 2D mode (height assumed constant and not computed).
Error	u1			PVT error code. The following values are defined: 0: No Error 1: Not enough measurements 2: Not enough ephemerides available 3: DOP too large (larger than 15) 4: Sum of squared residuals too large 5: No convergence 6: Not enough measurements after outlier rejection 7: Position output prohibited due to export laws 8: Not enough differential corrections available 9: Base station coordinates unavailable 10: Ambiguities not fixed and user requested to only output RTK-fixed positions
Latitude	f8	1 rad	$-2 \cdot 10^{10}$	Latitude, from $-\pi/2$ to $+\pi/2$, positive North of Equator
Longitude	f8	1 rad	$-2 \cdot 10^{10}$	Longitude, from $-\pi$ to $+\pi$, positive East of Greenwich
Height	f8	1 m	$-2 \cdot 10^{10}$	Ellipsoidal height (with respect to the ellipsoid specified by <code>Datum</code>)
Undulation	f4	1 m	$-2 \cdot 10^{10}$	Geoid undulation. See the <code>setGeoidUndulation</code> command.
Vn	f4	1 m / s	$-2 \cdot 10^{10}$	Velocity in the North direction
Ve	f4	1 m / s	$-2 \cdot 10^{10}$	Velocity in the East direction
Vu	f4	1 m / s	$-2 \cdot 10^{10}$	Velocity in the 'Up' direction

COG	f4	1 degree	$-2 \cdot 10^{10}$	Course over ground: this is defined as the angle of the vehicle with respect to the local level North, ranging from 0 to 360, and increasing towards east. Set to the Do-Not-Use value when the speed is lower than 0.1m/s.
RxClkBias	f8	1 ms	$-2 \cdot 10^{10}$	Receiver clock bias relative to the GNSS system time reported in the <code>TimeSystem</code> field. Positive when the receiver time is ahead of the system time. To transfer the receiver time to the system time, use: $t_{GPS/GST} = t_{rx} - RxClkBias$
RxClkDrift	f4	1 ppm	$-2 \cdot 10^{10}$	Receiver clock drift relative to the GNSS system time (relative frequency error). Positive when the receiver clock runs faster than the system time.
TimeSystem	u1		255	Time system of which the offset is provided in this sub-block: 0: GPS time 1: Galileo time 3: GLONASS time 4: BeiDou time
Datum	u1		255	This field defines in which datum the coordinates are expressed: 0: WGS84/ITRS 19: Datum equal to that used by the DGNSS/RTK base station 30: ETRS89 (ETRF2000 realization) 31: NAD83(2011), North American Datum (2011) 32: NAD83(PA11), North American Datum, Pacific plate (2011) 33: NAD83(MA11), North American Datum, Marianas plate (2011) 34: GDA94(2010), Geocentric Datum of Australia (2010) 35: GDA2020, Geocentric Datum of Australia 2020 250: First user-defined datum 251: Second user-defined datum
NrSV	u1		255	Total number of satellites used in the PVT computation.
WACorrInfo	u1		0	Bit field providing information about which wide area corrections have been applied: Bit 0: set if orbit and satellite clock correction information is used Bit 1: set if range correction information is used Bit 2: set if ionospheric information is used Bit 3: set if orbit accuracy information is used (UERE/SISA) Bit 4: set if DO229 Precision Approach mode is active Bits 5-7: Reserved
ReferenceID	u2		65535	This field indicates the reference ID of the differential information used. In case of DGPS or RTK operation, this field is to be interpreted as the base station identifier. In SBAS operation, this field is to be interpreted as the PRN of the geostationary satellite used (from 120 to 158). If multiple base stations or multiple geostationary satellites are used the value is set to 65534.
MeanCorrAge	u2	0.01 s	65535	In case of DGPS or RTK, this field is the mean age of the differential corrections. In case of SBAS operation, this field is the mean age of the 'fast corrections' provided by the SBAS satellites.
SignalInfo	u4		0	Bit field indicating the type of GNSS signals having been used in the PVT computations. If a bit i is set, the signal type having index i has been used. The signal numbers are listed in section 4.1.10. Bit 0 (GPS-C/A) is the LSB of <code>SignalInfo</code> .

Rev 1

AlertFlag	u1		0	Bit field indicating integrity related information: Bits 0-1: RAIM integrity flag: 0: RAIM not active (integrity not monitored) 1: RAIM integrity test successful 2: RAIM integrity test failed 3: Reserved Bit 2: set if integrity has failed as per Galileo HPCA (HMI Probability Computation Algorithm) Bit 3: set if Galileo ionospheric storm flag is active Bit 4: Reserved Bits 5-7: Reserved
NrBases	u1		0	Number of base stations used in the PVT computation.
PPPInfo	u2	1 s	0	Bit field containing PPP-related information: Bits 0-11: Age of the last seed, in seconds. The age is clipped to 4091s. This field must be ignored when the seed type is 0 (see bits 13-15 below). Bit 12: Reserved Bits 13-15: Type of last seed: 0: Not seeded or not in PPP positioning mode 1: Manual seed 2: Seeded from DGPS 3: Seeded from RTKFixed
Latency	u2	0.0001 s	65535	Time elapsed between the time of applicability of the position fix and the generation of this SBF block by the receiver. This time includes the receiver processing time, but not the communication latency.
HAccuracy	u2	0.01 m	65535	2DRMS horizontal accuracy: twice the root-mean-square of the horizontal distance error. The horizontal distance between the true position and the computed position is expected to be lower than $H_{Accuracy}$ with a probability of at least 95%. The value is clipped to $65534 = 655.34m$
VAccuracy	u2	0.01 m	65535	2-sigma vertical accuracy. The vertical distance between the true position and the computed position is expected to be lower than $V_{Accuracy}$ with a probability of at least 95%. The value is clipped to $65534 = 655.34m$.
Misc	u1			Bit field containing miscellaneous flags: Bit 0: In DGNSS or RTK mode, set if the baseline points to the base station ARP. Unset if it points to the antenna phase center, or if unknown. Bit 1: Set if the phase center offset is compensated for at the rover, unset if not or unknown. Bit 2: Proprietary. Bit 3: Proprietary. Bits 4-5: Proprietary. Bits 6-7: Flag indicating whether the marker position reported in this block is also the ARP position (i.e. whether the ARP-to-marker offset provided with the <code>setAntennaOffset</code> command is zero or not) 0: Unknown 1: The ARP-to-marker offset is zero 2: The ARP-to-marker offset is not zero
Padding	u1[.]			Padding bytes, see 4.1.5

Rev 2

PosCovCartesian	Number: 5905
	"OnChange" interval: default PVT output rate (see 4.1.8)

This block contains the elements of the symmetric variance-covariance matrix of the position expressed relative to the Cartesian axes of the coordinate system datum requested by the user:

$$\begin{pmatrix} \sigma_x^2 & \sigma_{xy} & \sigma_{xz} & \sigma_{xb} \\ \sigma_{yx} & \sigma_y^2 & \sigma_{yz} & \sigma_{yb} \\ \sigma_{zx} & \sigma_{zy} & \sigma_z^2 & \sigma_{zb} \\ \sigma_{bx} & \sigma_{by} & \sigma_{bz} & \sigma_b^2 \end{pmatrix}$$

This variance-covariance matrix contains an indication of the accuracy of the estimated parameters (see diagonal elements) and the correlation between these estimates (see off-diagonal elements). Note that the variances and covariances are estimated: they are not necessarily indicative of the actual scatter of the position estimates at a given site.

The position variance results from the propagation of all pseudorange variances using the observation geometry. The receiver implements a stochastic error model for individual measurements, based on parameters such as the C/N_0 , the satellite elevation, the pseudorange type, the URA of the broadcast ephemeris and the ionospheric model.

If the ellipsoidal height is not estimated (2D-mode), all components of the variance-covariance matrix are undefined and set to their Do-Not-Use value.

Parameter	Type	Units	Do-Not-Use	Description
Sync1	c1			Block Header, see 4.1.1
Sync2	c1			
CRC	u2			
ID	u2			
Length	u2	1 byte		
TOW	u4	0.001 s	4294967295	Receiver time stamp, see 4.1.3
WNc	u2	1 week	65535	
Mode	u1			Bit field indicating the PVT mode, as follows: Bits 0-3: type of PVT solution: 0: No PVT available (the <code>ERROR</code> field indicates the cause of the absence of the PVT solution) 1: Stand-Alone PVT 2: Differential PVT 3: Fixed location 4: RTK with fixed ambiguities 5: RTK with float ambiguities 6: SBAS aided PVT 7: moving-base RTK with fixed ambiguities 8: moving-base RTK with float ambiguities 10: Precise Point Positioning (PPP) 12: Reserved Bits 4-5: Reserved Bit 6: Set if the user has entered the command <code>setPVTMode, Static, auto</code> and the receiver is still in the process of determining its fixed position. Bit 7: 2D/3D flag: set in 2D mode (height assumed constant and not computed).
Error	u1			PVT error code. The following values are defined: 0: No Error 1: Not enough measurements 2: Not enough ephemerides available 3: DOP too large (larger than 15) 4: Sum of squared residuals too large 5: No convergence 6: Not enough measurements after outlier rejection 7: Position output prohibited due to export laws 8: Not enough differential corrections available 9: Base station coordinates unavailable 10: Ambiguities not fixed and user requested to only output RTK-fixed positions
Cov_xx	f4	1 m ²	$-2 \cdot 10^{10}$	Variance of the x estimate
Cov_yy	f4	1 m ²	$-2 \cdot 10^{10}$	Variance of the y estimate
Cov_zz	f4	1 m ²	$-2 \cdot 10^{10}$	Variance of the z estimate
Cov_bb	f4	1 m ²	$-2 \cdot 10^{10}$	Variance of the clock bias estimate
Cov_xy	f4	1 m ²	$-2 \cdot 10^{10}$	Covariance between the x and y estimates
Cov_xz	f4	1 m ²	$-2 \cdot 10^{10}$	Covariance between the x and z estimates
Cov_xb	f4	1 m ²	$-2 \cdot 10^{10}$	Covariance between the x and clock bias estimates
Cov_yz	f4	1 m ²	$-2 \cdot 10^{10}$	Covariance between the y and z estimates
Cov_yb	f4	1 m ²	$-2 \cdot 10^{10}$	Covariance between the y and clock bias estimates

Cov_zb	f4	1 m ²	$-2 \cdot 10^{10}$	Covariance between the z and clock bias estimates
Padding	u1[.]			Padding bytes, see 4.1.5

PosCovGeodetic	Number:	5906
	"OnChange" interval:	default PVT output rate (see 4.1.8)

This block contains the elements of the symmetric variance-covariance matrix of the position expressed in the geodetic coordinates in the datum requested by the user:

$$\begin{pmatrix} \sigma_{\phi}^2 & \sigma_{\phi\lambda} & \sigma_{\phi h} & \sigma_{\phi b} \\ \sigma_{\lambda\phi} & \sigma_{\lambda}^2 & \sigma_{\lambda h} & \sigma_{\lambda b} \\ \sigma_{h\phi} & \sigma_{h\lambda} & \sigma_h^2 & \sigma_{hb} \\ \sigma_{b\phi} & \sigma_{b\lambda} & \sigma_{bh} & \sigma_b^2 \end{pmatrix}$$

Please refer to the `PosCovCartesian` block description for a general explanation of the contents.

Note that the units of measure for all the variances and covariances, for height as well as for latitude and longitude, are m^2 for ease of interpretation.

If the ellipsoidal height is not estimated (2D-mode), all height related components of the variance-covariance matrix are undefined and set to their Do-Not-Use value.

Parameter	Type	Units	Do-Not-Use	Description
Sync1	c1			Block Header, see 4.1.1
Sync2	c1			
CRC	u2			
ID	u2			
Length	u2	1 byte		
TOW	u4	0.001 s	4294967295	Receiver time stamp, see 4.1.3
WNc	u2	1 week	65535	
Mode	u1			Bit field indicating the PVT mode, as follows: Bits 0-3: type of PVT solution: 0: No PVT available (the <code>ERROR</code> field indicates the cause of the absence of the PVT solution) 1: Stand-Alone PVT 2: Differential PVT 3: Fixed location 4: RTK with fixed ambiguities 5: RTK with float ambiguities 6: SBAS aided PVT 7: moving-base RTK with fixed ambiguities 8: moving-base RTK with float ambiguities 10: Precise Point Positioning (PPP) 12: Reserved Bits 4-5: Reserved Bit 6: Set if the user has entered the command <code>setPVTMode,Static,auto</code> and the receiver is still in the process of determining its fixed position. Bit 7: 2D/3D flag: set in 2D mode (height assumed constant and not computed).
Error	u1			PVT error code. The following values are defined: 0: No Error 1: Not enough measurements 2: Not enough ephemerides available 3: DOP too large (larger than 15) 4: Sum of squared residuals too large 5: No convergence 6: Not enough measurements after outlier rejection 7: Position output prohibited due to export laws 8: Not enough differential corrections available 9: Base station coordinates unavailable 10: Ambiguities not fixed and user requested to only output RTK-fixed positions
Cov_latlat	f4	1 m ²	$-2 \cdot 10^{10}$	Variance of the latitude estimate
Cov_lonlon	f4	1 m ²	$-2 \cdot 10^{10}$	Variance of the longitude estimate
Cov_hgthgt	f4	1 m ²	$-2 \cdot 10^{10}$	Variance of the height estimate
Cov_bb	f4	1 m ²	$-2 \cdot 10^{10}$	Variance of the clock-bias estimate
Cov_latlon	f4	1 m ²	$-2 \cdot 10^{10}$	Covariance between the latitude and longitude estimates
Cov_lathgt	f4	1 m ²	$-2 \cdot 10^{10}$	Covariance between the latitude and height estimates
Cov_latb	f4	1 m ²	$-2 \cdot 10^{10}$	Covariance between the latitude and clock-bias estimates
Cov_lonhgt	f4	1 m ²	$-2 \cdot 10^{10}$	Covariance between the longitude and height estimates

Cov_lonb	f4	1 m ²	$-2 \cdot 10^{10}$	Covariance between the longitude and clock-bias estimates
Cov_hb	f4	1 m ²	$-2 \cdot 10^{10}$	Covariance between the height and clock-bias estimates
Padding	u1[.]			Padding bytes, see 4.1.5

VelCovCartesian	Number: 5907
	"OnChange" interval: default PVT output rate (see 4.1.8)

This block contains the elements of the symmetric variance-covariance matrix of the velocity expressed in the Cartesian coordinates of the coordinate system datum requested by the user:

$$\begin{pmatrix} \sigma_{v_x}^2 & \sigma_{v_x v_y} & \sigma_{v_x v_z} & \sigma_{v_x d} \\ \sigma_{v_y v_x} & \sigma_{v_y}^2 & \sigma_{v_y v_z} & \sigma_{v_y d} \\ \sigma_{v_z v_x} & \sigma_{v_z v_y} & \sigma_{v_z}^2 & \sigma_{v_z d} \\ \sigma_{d v_x} & \sigma_{d v_y} & \sigma_{d v_z} & \sigma_d^2 \end{pmatrix}$$

Please refer to the `PosCovCartesian` block description for a general explanation of the contents.

If the up-velocity is not estimated (2D-mode), all components of the variance-covariance matrix are undefined and set to their Do-Not-Use value.

Parameter	Type	Units	Do-Not-Use	Description
Sync1	c1			Block Header, see 4.1.1
Sync2	c1			
CRC	u2			
ID	u2			
Length	u2	1 byte		
TOW	u4	0.001 s	4294967295	Receiver time stamp, see 4.1.3
WNc	u2	1 week	65535	
Mode	u1			Bit field indicating the PVT mode, as follows: Bits 0-3: type of PVT solution: 0: No PVT available (the <code>ERROR</code> field indicates the cause of the absence of the PVT solution) 1: Stand-Alone PVT 2: Differential PVT 3: Fixed location 4: RTK with fixed ambiguities 5: RTK with float ambiguities 6: SBAS aided PVT 7: moving-base RTK with fixed ambiguities 8: moving-base RTK with float ambiguities 10: Precise Point Positioning (PPP) 12: Reserved Bits 4-5: Reserved Bit 6: Set if the user has entered the command <code>setPVTMode, Static, auto</code> and the receiver is still in the process of determining its fixed position. Bit 7: 2D/3D flag: set in 2D mode (height assumed constant and not computed).
Error	u1			PVT error code. The following values are defined: 0: No Error 1: Not enough measurements 2: Not enough ephemerides available 3: DOP too large (larger than 15) 4: Sum of squared residuals too large 5: No convergence 6: Not enough measurements after outlier rejection 7: Position output prohibited due to export laws 8: Not enough differential corrections available 9: Base station coordinates unavailable 10: Ambiguities not fixed and user requested to only output RTK-fixed positions
Cov_VxVx	f4	$1 \text{ m}^2 / \text{s}^2$	$-2 \cdot 10^{10}$	Variance of the x-velocity estimate
Cov_VyVy	f4	$1 \text{ m}^2 / \text{s}^2$	$-2 \cdot 10^{10}$	Variance of the y-velocity estimate
Cov_VzVz	f4	$1 \text{ m}^2 / \text{s}^2$	$-2 \cdot 10^{10}$	Variance of the z-velocity estimate
Cov_DtDt	f4	$1 \text{ m}^2 / \text{s}^2$	$-2 \cdot 10^{10}$	Variance of the clock drift estimate
Cov_VxVy	f4	$1 \text{ m}^2 / \text{s}^2$	$-2 \cdot 10^{10}$	Covariance between the x- and y-velocity estimates
Cov_VxVz	f4	$1 \text{ m}^2 / \text{s}^2$	$-2 \cdot 10^{10}$	Covariance between the x- and z-velocity estimates
Cov_VxDt	f4	$1 \text{ m}^2 / \text{s}^2$	$-2 \cdot 10^{10}$	Covariance between the x-velocity and the clock drift estimates
Cov_VyVz	f4	$1 \text{ m}^2 / \text{s}^2$	$-2 \cdot 10^{10}$	Covariance between the y- and z-velocity estimates

Cov_VyDt	f4	$1 \text{ m}^2 / \text{s}^2$	$-2 \cdot 10^{10}$	Covariance between the y-velocity and the clock drift estimates
Cov_VzDt	f4	$1 \text{ m}^2 / \text{s}^2$	$-2 \cdot 10^{10}$	Covariance between the z-velocity and the clock drift estimates
Padding	u1[.]			Padding bytes, see 4.1.5

VelCovGeodetic	Number:	5908
	"OnChange" interval:	default PVT output rate (see 4.1.8)

This block contains the elements of the symmetric variance-covariance matrix of the velocity expressed in the geodetic coordinates in the datum requested by the user:

$$\begin{pmatrix} \sigma_{V_N}^2 & \sigma_{V_N V_E} & \sigma_{V_N V_U} & \sigma_{V_N d} \\ \sigma_{V_E V_N} & \sigma_{V_E}^2 & \sigma_{V_E V_U} & \sigma_{V_E d} \\ \sigma_{V_U V_N} & \sigma_{V_U V_E} & \sigma_{V_U}^2 & \sigma_{V_U d} \\ \sigma_{d V_N} & \sigma_{d V_E} & \sigma_{d V_U} & \sigma_d^2 \end{pmatrix}$$

Please refer to the `PosCovCartesian` block description for a general explanation of the contents.

If the up-velocity is not estimated (2D-mode), all up-velocity related components of the variance-covariance matrix are undefined and set to their Do-Not-Use value.

Parameter	Type	Units	Do-Not-Use	Description
Sync1	c1			Block Header, see 4.1.1
Sync2	c1			
CRC	u2			
ID	u2			
Length	u2	1 byte		
TOW	u4	0.001 s	4294967295	Receiver time stamp, see 4.1.3
WNc	u2	1 week	65535	
Mode	u1			Bit field indicating the PVT mode, as follows: Bits 0-3: type of PVT solution: 0: No PVT available (the <code>ERROR</code> field indicates the cause of the absence of the PVT solution) 1: Stand-Alone PVT 2: Differential PVT 3: Fixed location 4: RTK with fixed ambiguities 5: RTK with float ambiguities 6: SBAS aided PVT 7: moving-base RTK with fixed ambiguities 8: moving-base RTK with float ambiguities 10: Precise Point Positioning (PPP) 12: Reserved Bits 4-5: Reserved Bit 6: Set if the user has entered the command <code>setPVTMode, Static, auto</code> and the receiver is still in the process of determining its fixed position. Bit 7: 2D/3D flag: set in 2D mode (height assumed constant and not computed).
Error	u1			PVT error code. The following values are defined: 0: No Error 1: Not enough measurements 2: Not enough ephemerides available 3: DOP too large (larger than 15) 4: Sum of squared residuals too large 5: No convergence 6: Not enough measurements after outlier rejection 7: Position output prohibited due to export laws 8: Not enough differential corrections available 9: Base station coordinates unavailable 10: Ambiguities not fixed and user requested to only output RTK-fixed positions
Cov_VnVn	f4	$1 \text{ m}^2 / \text{s}^2$	$-2 \cdot 10^{10}$	Variance of the north-velocity estimate
Cov_VeVe	f4	$1 \text{ m}^2 / \text{s}^2$	$-2 \cdot 10^{10}$	Variance of the east-velocity estimate
Cov_VuVu	f4	$1 \text{ m}^2 / \text{s}^2$	$-2 \cdot 10^{10}$	Variance of the up-velocity estimate
Cov_DtDt	f4	$1 \text{ m}^2 / \text{s}^2$	$-2 \cdot 10^{10}$	Variance of the clock drift estimate
Cov_VnVe	f4	$1 \text{ m}^2 / \text{s}^2$	$-2 \cdot 10^{10}$	Covariance between the north- and east-velocity estimates
Cov_VnVu	f4	$1 \text{ m}^2 / \text{s}^2$	$-2 \cdot 10^{10}$	Covariance between the north- and up-velocity estimates
Cov_VnDt	f4	$1 \text{ m}^2 / \text{s}^2$	$-2 \cdot 10^{10}$	Covariance between the north-velocity and clock drift estimates
Cov_VeVu	f4	$1 \text{ m}^2 / \text{s}^2$	$-2 \cdot 10^{10}$	Covariance between the east- and up-velocity estimates

Cov_VeDt	f4	$1 \text{ m}^2 / \text{s}^2$	$-2 \cdot 10^{10}$	Covariance between the east-velocity and clock drift estimates
Cov_VuDt	f4	$1 \text{ m}^2 / \text{s}^2$	$-2 \cdot 10^{10}$	Covariance between the up-velocity and clock drift estimates
Padding	u1[.]			Padding bytes, see 4.1.5

DOP	Number:	4001
	"OnChange" interval:	default PVT output rate (see 4.1.8)

This block contains both Dilution of Precision (DOP) values and SBAS protection levels. The DOP values result from a trace of the unit position variance-covariance matrices:

$$\text{Position Dilution of Precision: } PDOP = \sqrt{Q_{xx} + Q_{yy} + Q_{zz}}$$

$$\text{Time Dilution of Precision: } TDOP = \sqrt{Q_{bb}}$$

$$\text{Horizontal Dilution of Precision: } HDOP = \sqrt{Q_{\lambda\lambda} + Q_{\phi\phi}}$$

$$\text{Vertical Dilution of Precision: } VDOP = \sqrt{Q_{hh}}$$

In these equations, the matrix \mathbf{Q} is the inverse of the unweighted normal matrix used for the computation of the position. The normal matrix equals the product of the geometry matrix A with its transpose ($A^t A$). The term "unweighted" implies that the DOP factor only addresses the effect of the geometric factors on the quality of the position.

The DOP values can be used to interpret the current constellation geometry. This is an important parameter for the quality of the position fix: the DOP parameter is the propagation factor of the pseudorange variance. For example, if an error of 5 m is present in the pseudorange, it will propagate into the horizontal plane with a factor expressed by the HDOP. Hence a low DOP value indicates that the satellites used for the position fix result in a low multiplication of the systematic ranging errors. A value of six (6) for the PDOP is generally considered as the maximum value allowed for an acceptable position computation.

The horizontal and vertical protection levels (HPL and VPL) indicate the integrity of the computed horizontal and vertical position components as per the DO 229 specification. In SBAS-aided PVT mode (see the `Mode` field of the `PVTCartesian` SBF block), HPL and VPL are based upon the error estimates provided by SBAS. Otherwise they are based upon internal position-mode dependent error estimates.

Parameter	Type	Units	Do-Not-Use	Description
Sync1	c1			Block Header, see 4.1.1
Sync2	c1			
CRC	u2			
ID	u2			
Length	u2	1 byte		
TOW	u4	0.001 s	4294967295	Receiver time stamp, see 4.1.3
WNc	u2	1 week	65535	
NrSV	u1		0	Total number of satellites used in the DOP computation, or 0 if the DOP information is not available (in that case, the <code>xDOP</code> fields are all set to 0)
Reserved	u1			Reserved for future use, to be ignored by decoding software
PDOP	u2	0.01	0	If 0, PDOP not available, otherwise divide by 100 to obtain PDOP.
TDOP	u2	0.01	0	If 0, TDOP not available, otherwise divide by 100 to obtain TDOP.
HDOP	u2	0.01	0	If 0, HDOP not available, otherwise divide by 100 to obtain HDOP.
VDOP	u2	0.01	0	If 0, VDOP not available, otherwise divide by 100 to obtain VDOP.
HPL	f4	1 m	$-2 \cdot 10^{10}$	Horizontal Protection Level (see the DO 229 standard).
VPL	f4	1 m	$-2 \cdot 10^{10}$	Vertical Protection Level (see the DO 229 standard).
Padding	u1[.]			Padding bytes, see 4.1.5

PosCart	Number: 4044
	"OnChange" interval: default PVT output rate (see 4.1.8)

This block contains the absolute and relative (relative to the nearest base station) position at the time specified in the `TOW` and `WNc` fields. The time of applicability is specified in the receiver time frame.

The absolute position (X , Y , Z) is reported in a Cartesian coordinate system using the datum indicated in the `Datum` field. The position is that of the marker. The ARP-to-marker offset is set through the command `setAntennaOffset`.

For highest accuracy, the receiver tries to compute the baseline (`Base2RoverX`, `Base2RoverY`, `Base2RoverZ`) from rover ARP to base ARP. See the description of the `BaseVectorCart` block for details.

Accurate ARP-to-ARP baseline is guaranteed only if both bits 0 and 1 of the `Misc` field are set. Otherwise, centimeter-level offsets may arise because the receiver cannot make the distinction between phase center and ARP positions. See section 2.5 for a discussion on the phase center and ARP positions.

This block also contains the variance-covariance information and DOP factors associated with the position.

Parameter	Type	Units	Do-Not-Use	Description
Sync1	c1			Block Header, see 4.1.1
Sync2	c1			
CRC	u2			
ID	u2			
Length	u2	1 byte		
TOW	u4	0.001 s	4294967295	Receiver time stamp, see 4.1.3
WNc	u2	1 week	65535	
Mode	u1			<p>Bit field indicating the PVT mode, as follows:</p> <p>Bits 0-3: type of PVT solution:</p> <ul style="list-style-type: none"> 0: No PVT available (the <code>ERROR</code> field indicates the cause of the absence of the PVT solution) 1: Stand-Alone PVT 2: Differential PVT 3: Fixed location 4: RTK with fixed ambiguities 5: RTK with float ambiguities 6: SBAS aided PVT 7: moving-base RTK with fixed ambiguities 8: moving-base RTK with float ambiguities 10: Precise Point Positioning (PPP) 12: Reserved <p>Bits 4-5: Reserved</p> <p>Bit 6: Set if the user has entered the command <code>setPVTMode,Static,auto</code> and the receiver is still in the process of determining its fixed position.</p> <p>Bit 7: 2D/3D flag: set in 2D mode (height assumed constant and not computed).</p>
Error	u1			<p>PVT error code. The following values are defined:</p> <ul style="list-style-type: none"> 0: No Error 1: Not enough measurements 2: Not enough ephemerides available 3: DOP too large (larger than 15) 4: Sum of squared residuals too large 5: No convergence 6: Not enough measurements after outlier rejection 7: Position output prohibited due to export laws 8: Not enough differential corrections available 9: Base station coordinates unavailable 10: Ambiguities not fixed and user requested to only output RTK-fixed positions
X	f8	1 m	$-2 \cdot 10^{10}$	X coordinate in coordinate frame specified by <code>Datum</code>
Y	f8	1 m	$-2 \cdot 10^{10}$	Y coordinate in coordinate frame specified by <code>Datum</code>
Z	f8	1 m	$-2 \cdot 10^{10}$	Z coordinate in coordinate frame specified by <code>Datum</code>
Base2RoverX	f8	1 m	$-2 \cdot 10^{10}$	X baseline component (from base to rover)
Base2RoverY	f8	1 m	$-2 \cdot 10^{10}$	Y baseline component (from base to rover)
Base2RoverZ	f8	1 m	$-2 \cdot 10^{10}$	Z baseline component (from base to rover)
Cov_xx	f4	1 m ²	$-2 \cdot 10^{10}$	Variance of the x estimate
Cov_yy	f4	1 m ²	$-2 \cdot 10^{10}$	Variance of the y estimate

Cov_zz	f4	1 m ²	$-2 \cdot 10^{10}$	Variance of the z estimate
Cov_xy	f4	1 m ²	$-2 \cdot 10^{10}$	Covariance between the x and y estimates
Cov_xz	f4	1 m ²	$-2 \cdot 10^{10}$	Covariance between the x and z estimates
Cov_yz	f4	1 m ²	$-2 \cdot 10^{10}$	Covariance between the y and z estimates
PDOP	u2	0.01	0	If 0, PDOP not available, otherwise divide by 100 to obtain PDOP.
HDOP	u2	0.01	0	If 0, HDOP not available, otherwise divide by 100 to obtain HDOP.
VDOP	u2	0.01	0	If 0, VDOP not available, otherwise divide by 100 to obtain VDOP.
Misc	u1			Bit field containing miscellaneous flags: Bit 0: In DGNSS or RTK mode, set if the baseline points to the base station ARP. Unset if it points to the antenna phase center, or if unknown. Bit 1: Set if the phase center offset is compensated for at the rover, unset if not or unknown. Bit 2: Proprietary. Bit 3: Proprietary. Bits 4-5: Proprietary. Bits 6-7: Flag indicating whether the marker position reported in this block is also the ARP position (i.e. whether the ARP-to-marker offset provided with the setAntennaOffset command is zero or not) 0: Unknown 1: The ARP-to-marker offset is zero 2: The ARP-to-marker offset is not zero
Reserved	u1			Reserved for future use.
AlertFlag	u1		0	Bit field indicating integrity related information: Bits 0-1: RAIM integrity flag: 0: RAIM not active (integrity not monitored) 1: RAIM integrity test successful 2: RAIM integrity test failed 3: Reserved Bit 2: set if integrity has failed as per Galileo HPCA (HMI Probability Computation Algorithm) Bit 3: set if Galileo ionospheric storm flag is active Bit 4: Reserved Bits 5-7: Reserved
Datum	u1		255	This field defines in which datum the coordinates are expressed: 0: WGS84/ITRS 19: Datum equal to that used by the DGNSS/RTK base station 30: ETRS89 (ETRF2000 realization) 31: NAD83(2011), North American Datum (2011) 32: NAD83(PA11), North American Datum, Pacific plate (2011) 33: NAD83(MA11), North American Datum, Marianas plate (2011) 34: GDA94(2010), Geocentric Datum of Australia (2010) 35: GDA2020, Geocentric Datum of Australia 2020 250: First user-defined datum 251: Second user-defined datum
NrSV	u1		255	Total number of satellites used in the PVT computation.

WACorrInfo	u1		0	<p>Bit field providing information about which wide area corrections have been applied:</p> <p>Bit 0: set if orbit and satellite clock correction information is used</p> <p>Bit 1: set if range correction information is used</p> <p>Bit 2: set if ionospheric information is used</p> <p>Bit 3: set if orbit accuracy information is used (UERE/SISA)</p> <p>Bit 4: set if DO229 Precision Approach mode is active</p> <p>Bits 5-7: Reserved</p>
ReferenceId	u2		65535	<p>This field indicates the reference ID of the differential information used. In case of DGPS or RTK operation, this field is to be interpreted as the base station identifier. In SBAS operation, this field is to be interpreted as the PRN of the geostationary satellite used (from 120 to 158). If multiple base stations or multiple geostationary satellites are used the value is set to 65534.</p>
MeanCorrAge	u2	0.01 s	65535	<p>In case of DGPS or RTK, this field is the mean age of the differential corrections.</p> <p>In case of SBAS operation, this field is the mean age of the 'fast corrections' provided by the SBAS satellites.</p>
SignalInfo	u4		0	<p>Bit field indicating the type of GNSS signals having been used in the PVT computations. If a bit i is set, the signal type having index i has been used. The signal numbers are listed in section 4.1.10. Bit 0 (GPS-C/A) is the LSB of <code>SignalInfo</code>.</p>
Padding	u1[.]			<p>Padding bytes, see 4.1.5</p>

PosLocal	Number:	4052
	"OnChange" interval:	default PVT output rate (see 4.1.8)

This block contains the position at the time specified in the `TOW` and `WNc` fields. The time of applicability is specified in the receiver time frame.

The position (Lat, Lon, Alt) relates to the local datum identified with the `Datum` field. The coordinate transformation to the local datum is done using parameters transmitted by the RTK service provider in RTCM message types MT1021 to MT1023.

The position is that of the marker. The ARP-to-marker offset is set through the command `setAntennaOffset`.

If no position is available, the `Error` field indicates the cause of the unavailability and all fields after the `Error` field are set to their respective Do-Not-Use values.

To be able to output a position in the `PosLocal` block, the receiver needs to have received the relevant RTCM transformation messages (at least either MT1021 or MT1022 is required). If they have not been received yet, the local position is not available and the `Error` field is set to value 17. See also section 2.4.5.

The corresponding `RTCMDatum` block provides information on the local datum name and transformation quality indicators. The corresponding `RTCMDatum` block is the one of which the `Datum` field matches the `Datum` field in the `PosLocal` block.

Parameter	Type	Units	Do-Not-Use	Description
Sync1	c1			Block Header, see 4.1.1
Sync2	c1			
CRC	u2			
ID	u2			
Length	u2	1 byte		
TOW	u4	0.001 s	4294967295	Receiver time stamp, see 4.1.3
WNc	u2	1 week	65535	
Mode	u1			Bit field indicating the PVT mode, as follows: Bits 0-3: type of PVT solution: 0: No PVT available (the <code>Error</code> field indicates the cause of the absence of the PVT solution) 1: Stand-Alone PVT 2: Differential PVT 3: Fixed location 4: RTK with fixed ambiguities 5: RTK with float ambiguities 6: SBAS aided PVT 7: moving-base RTK with fixed ambiguities 8: moving-base RTK with float ambiguities 10: Precise Point Positioning (PPP) 12: Reserved Bits 4-5: Reserved Bit 6: Set if the user has entered the command <code>setPVTMode,Static,auto</code> and the receiver is still in the process of determining its fixed position. Bit 7: 2D/3D flag: set in 2D mode (height assumed constant and not computed).

Error	u1			<p>PVT error code. The following values are defined:</p> <ul style="list-style-type: none"> 0: No Error 1: Not enough measurements 2: Not enough ephemerides available 3: DOP too large (larger than 15) 4: Sum of squared residuals too large 5: No convergence 6: Not enough measurements after outlier rejection 7: Position output prohibited due to export laws 8: Not enough differential corrections available 9: Base station coordinates unavailable 10: Ambiguities not fixed and user requested to only output RTK-fixed positions 17: Datum transformation parameters unknown
Lat	f8	1 rad	$-2 \cdot 10^{10}$	Latitude, from $-\pi/2$ to $+\pi/2$, positive North of Equator
Lon	f8	1 rad	$-2 \cdot 10^{10}$	Longitude, from $-\pi$ to $+\pi$, positive East of Greenwich
Alt	f8	1 m	$-2 \cdot 10^{10}$	Height. See the <code>HeightType</code> field of the corresponding <code>RTCMDatum</code> block for the interpretation of the height.
Datum	u1			Reference frame to which the position relate. If the value is in the 20 to 24 range, the corresponding datum parameters can be found in the <code>RTCMDatum</code> block having a matching <code>Datum</code> field. Value 25 corresponds to the local coordinate reference system selected with the <code>setLocalCoordOperation</code> command.
Padding	u1[.]			Padding bytes, see 4.1.5

PosProjected	Number:	4094
	"OnChange" interval:	default PVT output rate (see 4.1.8)

This block contains the projected coordinates at the time specified in the `TOW` and `WNc` fields. The time of applicability is specified in the receiver time frame.

The coordinates (Northing, Easting, Alt) relate to the local datum identified with the `Datum` field. The coordinate transformation and projection is done using parameters transmitted by the RTK service provider in RTCM message types MT1021 to MT1027.

The position is that of the marker. The ARP-to-marker offset is set through the command **setAntennaOffset**.

If no position is available, the `Error` field indicates the cause of the unavailability and all fields after the `Error` field are set to their respective Do-Not-Use values.

To be able to output a position in the `PosProjected` block, the receiver needs to have received at least one RTCM message in the MT1025 to MT1027 range. If none of these messages is sent out by the service provider, or if they have not been received yet, the projected position is not available and the `Error` field is set to value 17. See also section 2.4.5.

The corresponding `RTCMDatum` block provides information on the local datum name and transformation/projection quality indicators. The corresponding `RTCMDatum` block is the one of which the `Datum` field matches the `Datum` field in the `PosProjected` block.

Parameter	Type	Units	Do-Not-Use	Description
Sync1	c1			Block Header, see 4.1.1
Sync2	c1			
CRC	u2			
ID	u2			
Length	u2	1 byte		
TOW	u4	0.001 s	4294967295	Receiver time stamp, see 4.1.3
WNc	u2	1 week	65535	
Mode	u1			Bit field indicating the PVT mode, as follows: Bits 0-3: type of PVT solution: 0: No PVT available (the <code>Error</code> field indicates the cause of the absence of the PVT solution) 1: Stand-Alone PVT 2: Differential PVT 3: Fixed location 4: RTK with fixed ambiguities 5: RTK with float ambiguities 6: SBAS aided PVT 7: moving-base RTK with fixed ambiguities 8: moving-base RTK with float ambiguities 10: Precise Point Positioning (PPP) 12: Reserved Bits 4-5: Reserved Bit 6: Set if the user has entered the command <code>setPVTMode,Static,auto</code> and the receiver is still in the process of determining its fixed position. Bit 7: 2D/3D flag: set in 2D mode (height assumed constant and not computed).
Error	u1			PVT error code. The following values are defined: 0: No Error 1: Not enough measurements 2: Not enough ephemerides available 3: DOP too large (larger than 15) 4: Sum of squared residuals too large 5: No convergence 6: Not enough measurements after outlier rejection 7: Position output prohibited due to export laws 8: Not enough differential corrections available 9: Base station coordinates unavailable 10: Ambiguities not fixed and user requested to only output RTK-fixed positions 17: Datum transformation parameters unknown
Northing	f8	1 m	$-2 \cdot 10^{10}$	Northing coordinate in the plane grid representation.
Easting	f8	1 m	$-2 \cdot 10^{10}$	Easting coordinate in the plane grid representation.
Alt	f8	1 m	$-2 \cdot 10^{10}$	Height. If the <code>Datum</code> field is in the 20 to 24 range, see the <code>HeightType</code> field of the corresponding <code>RTCMDatum</code> block for the interpretation of the height.
Datum	u1			Reference frame to which the position relate. If the value is in the 20 to 24 range, the corresponding datum parameters can be found in the <code>RTCMDatum</code> block having a matching <code>Datum</code> field. Value 25 corresponds to the local coordinate reference system selected with the <code>setLocalCoordOperation</code> command.
Padding	u1[.]			Padding bytes, see 4.1.5

BaseVectorCart	Number:	4043
	"OnChange" interval:	default PVT output rate (see 4.1.8)

The `BaseVectorCart` block contains the relative position and orientation of one or more base stations, as seen from the rover (i.e. this receiver). The relative position is expressed in the Cartesian X, Y, Z directions.

For highest accuracy, the receiver tries to compute the baseline from rover antenna reference point (ARP) to base ARP. This requires to compensate for the phase center offset at both the base and the rover antennas. This is possible if two conditions are met:

- the base station must transmit its antenna parameters in RTCM2 message types 23 and 24 or in RTCM3 message types 1005/1006 and 1007/1008. Older RTCM2 messages and CMR do not allow phase center offset compensation.
- the base and rover antenna types must belong to the list returned by the command `lstAntennaInfo`, **overview**. (see the description of the commands `setAntennaOffset` and `lstAntennaInfo` for details).

Accurate ARP-to-ARP baseline is guaranteed only if both bits 0 and 1 of the `Misc` field are set. Otherwise, centimeter-level offsets may arise because the receiver cannot make the distinction between phase center and ARP positions. See section 2.5 for a discussion on the phase center and ARP positions.

The block supports multi-base operation. It contains as many sub-blocks as available base stations, each sub-block containing the baseline relative to a single base station identified by the `ReferenceID` field.

Parameter	Type	Units	Do-Not-Use	Description
Sync1	c1			Block Header, see 4.1.1
Sync2	c1			
CRC	u2			
ID	u2			
Length	u2	1 byte		
TOW	u4	0.001 s	4294967295	Receiver time stamp, see 4.1.3
WNc	u2	1 week	65535	
N	u1			Number of baselines for which relative position, velocity and direction are provided in this SBF block, i.e. number of <code>VectorInfoCart</code> sub-blocks. If <code>N</code> is 0, there are no baseline available for this epoch.
SBLength	u1	1 byte		Length of one sub-block
<i>VectorInfoCart</i>		<i>A succession of N VectorInfoCart sub-blocks, see definition below</i>
Padding	u1[.]			Padding bytes, see 4.1.5

VectorInfoCart sub-block definition:

Parameter	Type	Units	Do-Not-Use	Description
nrSV	u1			Number of satellites for which corrections are available from the base station identified by the <code>ReferenceID</code> field.
Error	u1			PVT error code. The following values are defined: 0: No Error 1: Not enough measurements 2: Not enough ephemerides available 3: DOP too large (larger than 15) 4: Sum of squared residuals too large 5: No convergence 6: Not enough measurements after outlier rejection 7: Position output prohibited due to export laws 8: Not enough differential corrections available 9: Base station coordinates unavailable 10: Ambiguities not fixed and user requested to only output RTK-fixed positions
Mode	u1			Bit field indicating the PVT mode, as follows: Bits 0-3: type of PVT solution: 0: No PVT available (the <code>Error</code> field indicates the cause of the absence of the PVT solution) 1: Stand-Alone PVT 2: Differential PVT 3: Fixed location 4: RTK with fixed ambiguities 5: RTK with float ambiguities 6: SBAS aided PVT 7: moving-base RTK with fixed ambiguities 8: moving-base RTK with float ambiguities 10: Precise Point Positioning (PPP) 12: Reserved Bits 4-5: Reserved Bit 6: Set if the user has entered the command <code>setPVTMode,Static,auto</code> and the receiver is still in the process of determining its fixed position. Bit 7: 2D/3D flag: set in 2D mode (height assumed constant and not computed).
Misc	u1			Bit field containing miscellaneous flags: Bit 0: Set if the baseline points to the base station ARP. Unset if it points to the antenna phase center, or if unknown. Bit 1: Set if the phase center offset is compensated for at the rover (i.e. the baseline starts from the antenna ARP), unset if not or unknown. Bit 2: Proprietary. Bit 3: Proprietary. Bits 4-5: Proprietary. Bits 6-7: Reserved
DeltaX	f8	1 m	$-2 \cdot 10^{10}$	X baseline component (from rover to base)
DeltaY	f8	1 m	$-2 \cdot 10^{10}$	Y baseline component (from rover to base)
DeltaZ	f8	1 m	$-2 \cdot 10^{10}$	Z baseline component (from rover to base)

DeltaVx	f4	1 m / s	$-2 \cdot 10^{10}$	X velocity of base with respect to rover
DeltaVy	f4	1 m / s	$-2 \cdot 10^{10}$	Y velocity of base with respect to rover
DeltaVz	f4	1 m / s	$-2 \cdot 10^{10}$	Z velocity of base with respect to rover
Azimuth	u2	0.01 degrees	65535	Azimuth of the base station (from 0 to 360°, increasing towards east)
Elevation	i2	0.01 degrees	-32768	Elevation of the base station (from -90° to 90°)
ReferenceID	u2			Base station ID
CorrAge	u2	0.01 s	65535	Age of the oldest differential correction used for this baseline computation.
SignalInfo	u4		0	Bit field indicating the GNSS signals for which differential corrections are available from the base station identified by ReferenceID. If bit <i>i</i> is set, corrections for the signal type having index <i>i</i> are available. The signal numbers are listed in section 4.1.10. Bit 0 (GPS-C/A) is the LSB of SignalInfo.
Padding	u1[.]			Padding bytes, see 4.1.5

<code>BaseVectorGeod</code>	Number: 4028 "OnChange" interval: default PVT output rate (see 4.1.8)
-----------------------------	--

The `BaseVectorGeod` block contains the relative position and orientation of one or more base stations, as seen from the rover (i.e. this receiver). The relative position is expressed in the East-North-Up directions.

For highest accuracy, the receiver tries to compute the baseline from rover antenna reference point (ARP) to base ARP. See the description of the `BaseVectorCart` block for details.

Accurate ARP-to-ARP baseline is guaranteed only if both bits 0 and 1 of the `Misc` field are set. Otherwise, centimeter-level offsets may arise because the receiver cannot make the distinction between phase center and ARP positions. See section 2.5 for a discussion on the phase center and ARP positions.

The block supports multi-base operation. It contains as many sub-blocks as available base stations, each sub-block containing the baseline coordinates relative to a single base station identified by the `ReferenceID` field.

Parameter	Type	Units	Do-Not-Use	Description
<code>Sync1</code>	c1			Block Header, see 4.1.1
<code>Sync2</code>	c1			
<code>CRC</code>	u2			
<code>ID</code>	u2			
<code>Length</code>	u2	1 byte		
<code>TOW</code>	u4	0.001 s	4294967295	Receiver time stamp, see 4.1.3
<code>WNc</code>	u2	1 week	65535	
<code>N</code>	u1			Number of baselines for which relative position, velocity and direction are provided in this SBF block, i.e. number of <code>VectorInfoGeod</code> sub-blocks. If <code>N</code> is 0, there are no baseline available for this epoch.
<code>SBLength</code>	u1	1 byte		Length of one sub-block
<code>VectorInfoGeod</code>		A succession of <i>N</i> <code>VectorInfoGeod</code> sub-blocks, see definition below
<code>Padding</code>	u1[.]			Padding bytes, see 4.1.5

VectorInfoGeod sub-block definition:

Parameter	Type	Units	Do-Not-Use	Description
NrSV	u1			Number of satellites for which corrections are available from the base station identified by the <code>ReferenceID</code> field.
Error	u1			PVT error code. The following values are defined: 0: No Error 1: Not enough measurements 2: Not enough ephemerides available 3: DOP too large (larger than 15) 4: Sum of squared residuals too large 5: No convergence 6: Not enough measurements after outlier rejection 7: Position output prohibited due to export laws 8: Not enough differential corrections available 9: Base station coordinates unavailable 10: Ambiguities not fixed and user requested to only output RTK-fixed positions
Mode	u1			Bit field indicating the PVT mode, as follows: Bits 0-3: type of PVT solution: 0: No PVT available (the <code>Error</code> field indicates the cause of the absence of the PVT solution) 1: Stand-Alone PVT 2: Differential PVT 3: Fixed location 4: RTK with fixed ambiguities 5: RTK with float ambiguities 6: SBAS aided PVT 7: moving-base RTK with fixed ambiguities 8: moving-base RTK with float ambiguities 10: Precise Point Positioning (PPP) 12: Reserved Bits 4-5: Reserved Bit 6: Set if the user has entered the command <code>setPVTMode,Static,auto</code> and the receiver is still in the process of determining its fixed position. Bit 7: 2D/3D flag: set in 2D mode (height assumed constant and not computed).
Misc	u1			Bit field containing miscellaneous flags: Bit 0: Set if the baseline points to the base station ARP. Unset if it points to the antenna phase center, or if unknown. Bit 1: Set if the phase center offset is compensated for at the rover (i.e. the baseline starts from the antenna ARP), unset if not or unknown. Bit 2: Proprietary. Bit 3: Proprietary. Bits 4-5: Proprietary. Bits 6-7: Reserved
DeltaEast	f8	1 m	$-2 \cdot 10^{10}$	East baseline component (from rover to base)
DeltaNorth	f8	1 m	$-2 \cdot 10^{10}$	North baseline component (from rover to base)
DeltaUp	f8	1 m	$-2 \cdot 10^{10}$	Up baseline component (from rover to base)

DeltaVe	f4	1 m / s	$-2 \cdot 10^{10}$	East velocity of base with respect to rover
DeltaVn	f4	1 m / s	$-2 \cdot 10^{10}$	North velocity of base with respect to rover
DeltaVu	f4	1 m / s	$-2 \cdot 10^{10}$	Up velocity of base with respect to rover
Azimuth	u2	0.01 degrees	65535	Azimuth of the base station (from 0 to 360°, increasing towards east)
Elevation	i2	0.01 degrees	-32768	Elevation of the base station (from -90° to 90°)
ReferenceID	u2			Base station ID
CorrAge	u2	0.01 s	65535	Age of the oldest differential correction used for this baseline computation.
SignalInfo	u4		0	Bit field indicating the GNSS signals for which differential corrections are available from the base station identified by ReferenceID. If bit <i>i</i> is set, corrections for the signal type having index <i>i</i> are available. The signal numbers are listed in section 4.1.10. Bit 0 (GPS-C/A) is the LSB of SignalInfo.
Padding	u1[.]			Padding bytes, see 4.1.5

PVTSupport	Number: 4076
	"OnChange" interval: default PVT output rate (see 4.1.8)

This block contains various internal parameters that can be used for maintenance and support.

The detailed definition of this block is not available in this document.

PVTSupportA	Number: 4079
	"OnChange" interval: default PVT output rate (see 4.1.8)

This block contains various internal parameters that can be used for maintenance and support.

The detailed definition of this block is not available in this document.

EndOfPVT	Number: 5921 "OnChange" interval: default PVT output rate (see 4.1.8)
----------	--

This block marks the end of transmission of all PVT related blocks belonging to the same epoch.

Parameter	Type	Units	Do-Not-Use	Description
Sync1	c1			Block Header, see 4.1.1
Sync2	c1			
CRC	u2			
ID	u2			
Length	u2	1 byte		
TOW	u4	0.001 s	4294967295	Receiver time stamp, see 4.1.3
WNc	u2	1 week	65535	
Padding	u1[.]			Padding bytes, see 4.1.5

4.2.10 GNSS Attitude Blocks

AttEuler	Number:	5938
	"OnChange" interval:	default PVT output rate (see 4.1.8)

The AttEuler block contains the Euler angles (pitch, roll and heading) at the time specified in the TOW and WNc fields (in the receiver time frame).

Parameter	Type	Units	Do-Not-Use	Description
Sync1	c1			Block Header, see 4.1.1
Sync2	c1			
CRC	u2			
ID	u2			
Length	u2	1 byte		
TOW	u4	0.001 s	4294967295	Receiver time stamp, see 4.1.3
WNc	u2	1 week	65535	
NrSV	u1		255	The average over all antennas of the number of satellites currently included in the attitude calculations.
Error	u1			Bit field providing error information. For each antenna baseline, two bits are used to provide error information: Bits 0-1: Error code for Main-Aux1 baseline: 0: No error 1: Not enough measurements 2: Reserved 3: Reserved Bits 2-3: Error code for Main-Aux2 baseline, same definition as bit 0-1. Bits 4-6: Reserved Bit 7: Set when GNSS-based attitude not requested by user. In that case, the other bits are all zero.
Mode	u2			Attitude mode code: 0: No attitude 1: Heading, pitch (roll = 0), aux antenna positions obtained with float ambiguities 2: Heading, pitch (roll = 0), aux antenna positions obtained with fixed ambiguities 3: Heading, pitch, roll, aux antenna positions obtained with float ambiguities 4: Heading, pitch, roll, aux antenna positions obtained with fixed ambiguities
Reserved	u2			Reserved for future use, to be ignored by decoding software
Heading	f4	1 degree	$-2 \cdot 10^{10}$	Heading
Pitch	f4	1 degree	$-2 \cdot 10^{10}$	Pitch
Roll	f4	1 degree	$-2 \cdot 10^{10}$	Roll
PitchDot	f4	1 degree / s	$-2 \cdot 10^{10}$	Rate of change of the pitch angle
RollDot	f4	1 degree / s	$-2 \cdot 10^{10}$	Rate of change of the roll angle
HeadingDot	f4	1 degree / s	$-2 \cdot 10^{10}$	Rate of change of the heading angle
Padding	u1[.]			Padding bytes, see 4.1.5

AttCovEuler	Number:	5939
	"OnChange" interval:	default PVT output rate (see 4.1.8)

This block contains the elements of the symmetric variance-covariance matrix of the attitude angles reported in the `AttEuler` block

$$\begin{pmatrix} \sigma_{\phi}^2 & \sigma_{\phi\theta} & \sigma_{\phi\psi} \\ \sigma_{\theta\phi} & \sigma_{\theta}^2 & \sigma_{\theta\psi} \\ \sigma_{\psi\phi} & \sigma_{\psi\theta} & \sigma_{\psi}^2 \end{pmatrix}$$

This variance-covariance matrix contains an indication of the accuracy of the estimated parameters (see diagonal elements) and the correlation between these estimates (see off-diagonal elements).

In case the receiver is in heading and pitch mode only, only the heading and pitch variance values will be valid. All other components of the variance-covariance matrix are set to their Do-Not-Use value.

Parameter	Type	Units	Do-Not-Use	Description
Sync1	c1			Block Header, see 4.1.1
Sync2	c1			
CRC	u2			
ID	u2			
Length	u2	1 byte		
TOW	u4	0.001 s	4294967295	Receiver time stamp, see 4.1.3
WNc	u2	1 week	65535	
Reserved	u1			Reserved for future use, to be ignored by decoding software
Error	u1			Bit field providing error information. For each antenna baseline, two bits are used to provide error information: Bits 0-1: Error code for Main-Aux1 baseline: 0: No error 1: Not enough measurements 2: Reserved 3: Reserved Bits 2-3: Error code for Main-Aux2 baseline, same definition as bit 0-1. Bits 4-6: Reserved Bit 7: Set when GNSS-based attitude not requested by user. In that case, the other bits are all zero.
Cov_HeadHead	f4	1 degree ²	-2 · 10 ¹⁰	Variance of the heading estimate
Cov_PitchPitch	f4	1 degree ²	-2 · 10 ¹⁰	Variance of the pitch estimate
Cov_RollRoll	f4	1 degree ²	-2 · 10 ¹⁰	Variance of the roll estimate
Cov_HeadPitch	f4	1 degree ²	-2 · 10 ¹⁰	Covariance between Euler angle estimates. Future functionality. The values are currently set to their Do-Not-Use values.
Cov_HeadRoll	f4	1 degree ²	-2 · 10 ¹⁰	Covariance between Euler angle estimates. Future functionality. The values are currently set to their Do-Not-Use values.
Cov_PitchRoll	f4	1 degree ²	-2 · 10 ¹⁰	Covariance between Euler angle estimates. Future functionality. The values are currently set to their Do-Not-Use values.
Padding	u1[.]			Padding bytes, see 4.1.5

EndOfAtt	Number: 5943 "OnChange" interval: default PVT output rate (see 4.1.8)
----------	--

This block marks the end of transmission of all GNSS-attitude related blocks belonging to the same epoch.

Parameter	Type	Units	Do-Not-Use	Description
Sync1	c1			Block Header, see 4.1.1
Sync2	c1			
CRC	u2			
ID	u2			
Length	u2	1 byte		
TOW	u4	0.001 s	4294967295	Receiver time stamp, see 4.1.3
WNc	u2	1 week	65535	
Padding	u1[.]			Padding bytes, see 4.1.5

4.2.11 Receiver Time Blocks

ReceiverTime	Number: 5914
	"OnChange" interval: 1s

The `ReceiverTime` block provides the current time with a 1-second resolution in the receiver time scale and UTC.

The level of synchronization of the receiver time with the satellite system time is provided in the `SyncLevel` field.

UTC time is provided if the UTC parameters have been received from at least one GNSS satellite. If the UTC time is not available, the corresponding fields are set to their Do-Not-Use value.

Parameter	Type	Units	Do-Not-Use	Description
Sync1	c1			Block Header, see 4.1.1
Sync2	c1			
CRC	u2			
ID	u2			
Length	u2	1 byte		
TOW	u4	0.001 s	4294967295	Receiver time stamp, see 4.1.3
WNc	u2	1 week	65535	
UTCYear	i1	1 year	-128	Current year in the UTC time scale (2 digits). From 0 to 99, or -128 if not available
UTCMonth	i1	1 month	-128	Current month in the UTC time scale. From 1 to 12, or -128 if not available
UTCDay	i1	1 day	-128	Current day in the UTC time scale. From 1 to 31, or -128 if not available
UTCHour	i1	1 hour	-128	Current hour in the UTC time scale. From 0 to 23, or -128 if not available
UTCMin	i1	1 minute	-128	Current minute in the UTC time scale. From 0 to 59, or -128 if not available
UTCSec	i1	1 s	-128	Current second in the UTC time scale. From 0 to 59, or -128 if not available
DeltaLS	i1	1 s	-128	Integer second difference between UTC time and GPS system time. Positive if GPS time is ahead of UTC. Set to -128 if not available.
SyncLevel	u1			Bit field indicating the synchronization level of the receiver time. If bits 0 to 2 are set, full synchronization is achieved: Bit 0: WNSSET: if this bit is set, the receiver week number is set. Bit 1: TOWSET: if this bit is set, the receiver time-of-week is set to within 20ms. Bit 2: FINETIME: if this bit is set, the receiver time-of-week is within the limit specified by the <code>setClockSyncThreshold</code> command. Bit 3: Reserved Bit 4: i Reserved Bits 5-7: Reserved
Padding	u1[.]			Padding bytes, see 4.1.5

xPPSOffset	Number: 5911 "OnChange" interval: PPS rate
------------	---

The `xPPSOffset` block contains the offset between the true xPPS pulse and the actual pulse output by the receiver. It is output right after each xPPS pulse.

Parameter	Type	Units	Do-Not-Use	Description
Sync1	c1			Block Header, see 4.1.1
Sync2	c1			
CRC	u2			
ID	u2			
Length	u2	1 byte		
TOW	u4	0.001 s	4294967295	Receiver time stamp, see 4.1.3
WNc	u2	1 week	65535	
SyncAge	u1	1 s		Age of the last synchronization to system time. The xPPS pulse is regularly resynchronized with system time. This field indicates the number of seconds elapsed since the last resynchronization. <code>SyncAge</code> is constrained to the 0-255s range. If the age is higher than 255s, <code>SyncAge</code> is set to 255. If the PPS is synchronized with the internal receiver time (<code>Timescale = 3</code>), <code>SyncAge</code> is always set to 0.
TimeScale	u1			Time reference to which the xPPS pulse is referenced. The following values are defined (see also the <code>setPPSParameters</code> command) 1: GNSS system time specified by the <code>setTimingSystem</code> command 2: UTC 3: receiver time 4: GLONASS time
Offset	f4	$1 \cdot 10^{-9}$ s		Offset of the xPPS output by the receiver with respect to its true position. <code>Offset</code> is negative when the xPPS pulse is in advance with respect to its true position. See also section 1.18 for an explanation of the xPPS generation principle, and for a description of the xPPS offset.
Padding	u1[.]			Padding bytes, see 4.1.5

4.2.12 External Event Blocks

These blocks report the state of the receiver applicable at the instant of a level transition on one of its “Event” pins. The receiver time is reported in the `ExtEvent` SBF block, and the receiver position is reported in the `ExtEventPVTCartesian` and the `ExtEventPVTGeodetic` blocks.

If enabled, upon detection of an event, these three blocks are output in the following order, with no other SBF blocks in between them:

1. `ExtEvent`;
2. `ExtEventPVTCartesian`;
3. `ExtEventPVTGeodetic`.

All blocks referring to the same event contain the same time stamp in the `TOW` and `WNC` fields.

ExtEvent	Number: 5924
	"OnChange" interval: each time an event is detected

The ExtEvent block contains the time tag of a voltage transition on one of the "Event" input pins.

Parameter	Type	Units	Do-Not-Use	Description
Sync1	c1			Block Header, see 4.1.1
Sync2	c1			
CRC	u2			
ID	u2			
Length	u2	1 byte		
TOW	u4	0.001 s	4294967295	External time stamp, see 4.1.3
WNc	u2	1 week	65535	
Source	u1			Input pin where this external event has been detected. The following values are defined: 1: EventA 2: EventB
Polarity	u1			0: rising edge event 1: falling edge event
Offset	f4	1 s		Event time offset with respect to TOW, including the potential delay specified with the setEventParameters command. The time of week of the external event is given by: $t_{\text{ext,rx}} [\text{s}] = \text{TOW}/1000 + \text{Offset}$ $t_{\text{ext,rx}}$ refers to the receiver system time scale. Use the RxClkBias field to convert this time to the GNSS time scale.
RxClkBias	f8	1 s	$-2 \cdot 10^{10}$	Receiver clock bias at the time of event. The clock bias is relative to the system time specified by the setTimingSystem command. To get the time of week of the external event in that system time scale, use: $t_{\text{ext,GNSS}} [\text{s}] = \text{TOW}/1000 + \text{Offset} - \text{RxClkBias}$. The accuracy of the clock bias is dependent on the age of the last PVT solution. When the receiver has been unable to compute a PVT during the last 10 minutes, this field is set to its Do-Not-Use value.
PVTAge	u2	1 s		Age of the last PVT solution. If the PVT age is larger than 10 minutes (600s), this value is clipped to 600.
Padding	u1[.]			Padding bytes, see 4.1.5

ExtEventPVTCartesian	Number: 4037 "OnChange" interval: each time an external event is detected
----------------------	--

This block contains the position, velocity and time (PVT) solution applicable at the time of an external event, in a Cartesian coordinate system.

This block has the same structure and description as the `PVTCartesian` block, except that the `TOW` and `WNc` fields refer to the time at which the electrical transition on the event pin has been detected (with a millisecond resolution), and that the position is computed at the event time, taking into account a possible user-defined delay set by the **setEventParameters** command.

A user needing the sub-millisecond part of the event time must refer to the `Offset` field of the corresponding `ExtEvent` block. The corresponding `ExtEvent` block is the last of the `ExtEvent` blocks having been output by the receiver.

Parameter	Type	Units	Do-Not-Use	Description
Sync1	c1			Block Header, see 4.1.1
Sync2	c1			
CRC	u2			
ID	u2			
Length	u2	1 byte		
TOW	u4	0.001 s	4294967295	External time stamp, see 4.1.3
WNc	u2	1 week	65535	
Mode	u1			<p>Bit field indicating the PVT mode, as follows:</p> <p>Bits 0-3: type of PVT solution:</p> <ul style="list-style-type: none"> 0: No PVT available (the <code>ERROR</code> field indicates the cause of the absence of the PVT solution) 1: Stand-Alone PVT 2: Differential PVT 3: Fixed location 4: RTK with fixed ambiguities 5: RTK with float ambiguities 6: SBAS aided PVT 7: moving-base RTK with fixed ambiguities 8: moving-base RTK with float ambiguities 10: Precise Point Positioning (PPP) 12: Reserved <p>Bits 4-5: Reserved</p> <p>Bit 6: Set if the user has entered the command <code>setPVTMode, Static, auto</code> and the receiver is still in the process of determining its fixed position.</p> <p>Bit 7: 2D/3D flag: set in 2D mode (height assumed constant and not computed).</p>
Error	u1			<p>PVT error code. The following values are defined:</p> <ul style="list-style-type: none"> 0: No Error 1: Not enough measurements 2: Not enough ephemerides available 3: DOP too large (larger than 15) 4: Sum of squared residuals too large 5: No convergence 6: Not enough measurements after outlier rejection 7: Position output prohibited due to export laws 8: Not enough differential corrections available 9: Base station coordinates unavailable 10: Ambiguities not fixed and user requested to only output RTK-fixed positions
X	f8	1 m	$-2 \cdot 10^{10}$	X coordinate in coordinate frame specified by <code>Datum</code>
Y	f8	1 m	$-2 \cdot 10^{10}$	Y coordinate in coordinate frame specified by <code>Datum</code>
Z	f8	1 m	$-2 \cdot 10^{10}$	Z coordinate in coordinate frame specified by <code>Datum</code>
Undulation	f4	1 m	$-2 \cdot 10^{10}$	Geoid undulation. See the <code>setGeoidUndulation</code> command.
Vx	f4	1 m / s	$-2 \cdot 10^{10}$	Not applicable
Vy	f4	1 m / s	$-2 \cdot 10^{10}$	Not applicable
Vz	f4	1 m / s	$-2 \cdot 10^{10}$	Not applicable

COG	f4	1 degree	$-2 \cdot 10^{10}$	Course over ground: this is defined as the angle of the vehicle with respect to the local level North, ranging from 0 to 360, and increasing towards east. Set to the Do-Not-Use value when the speed is lower than 0.1m/s.
RxClkBias	f8	1 ms	$-2 \cdot 10^{10}$	Receiver clock bias relative to the GNSS system time reported in the <code>TimeSystem</code> field. Positive when the receiver time is ahead of the system time. To transfer the receiver time to the system time, use: $t_{GPS/GST} = t_{rx} - RxClkBias$
RxClkDrift	f4	1 ppm	$-2 \cdot 10^{10}$	Receiver clock drift relative to the GNSS system time (relative frequency error). Positive when the receiver clock runs faster than the system time.
TimeSystem	u1		255	Time system of which the offset is provided in this sub-block: 0: GPS time 1: Galileo time 3: GLONASS time 4: BeiDou time
Datum	u1		255	This field defines in which datum the coordinates are expressed: 0: WGS84/ITRS 19: Datum equal to that used by the DGNSS/RTK base station 30: ETRS89 (ETRF2000 realization) 31: NAD83(2011), North American Datum (2011) 32: NAD83(PA11), North American Datum, Pacific plate (2011) 33: NAD83(MA11), North American Datum, Marianas plate (2011) 34: GDA94(2010), Geocentric Datum of Australia (2010) 35: GDA2020, Geocentric Datum of Australia 2020 250: First user-defined datum 251: Second user-defined datum
NrSV	u1		255	Total number of satellites used in the PVT computation.
WACorrInfo	u1		0	Bit field providing information about which wide area corrections have been applied: Bit 0: set if orbit and satellite clock correction information is used Bit 1: set if range correction information is used Bit 2: set if ionospheric information is used Bit 3: set if orbit accuracy information is used (UERE/SISA) Bit 4: set if DO229 Precision Approach mode is active Bits 5-7: Reserved
ReferenceID	u2		65535	This field indicates the reference ID of the differential information used. In case of DGPS or RTK operation, this field is to be interpreted as the base station identifier. In SBAS operation, this field is to be interpreted as the PRN of the geostationary satellite used (from 120 to 158). If multiple base stations or multiple geostationary satellites are used the value is set to 65534.
MeanCorrAge	u2	0.01 s	65535	In case of DGPS or RTK, this field is the mean age of the differential corrections. In case of SBAS operation, this field is the mean age of the 'fast corrections' provided by the SBAS satellites.
SignalInfo	u4		0	Bit field indicating the type of GNSS signals having been used in the PVT computations. If a bit i is set, the signal type having index i has been used. The signal numbers are listed in section 4.1.10. Bit 0 (GPS-C/A) is the LSB of <code>SignalInfo</code> .

Rev 1

AlertFlag	u1		0	Bit field indicating integrity related information: Bits 0-1: RAIM integrity flag: 0: RAIM not active (integrity not monitored) 1: RAIM integrity test successful 2: RAIM integrity test failed 3: Reserved Bit 2: set if integrity has failed as per Galileo HPCA (HMI Probability Computation Algorithm) Bit 3: set if Galileo ionospheric storm flag is active Bit 4: Reserved Bits 5-7: Reserved
NrBases	u1		0	Number of base stations used in the PVT computation.
PPPInfo	u2	1 s	0	Bit field containing PPP-related information: Bits 0-11: Age of the last seed, in seconds. The age is clipped to 4091s. This field must be ignored when the seed type is 0 (see bits 13-15 below). Bit 12: Reserved Bits 13-15: Type of last seed: 0: Not seeded or not in PPP positioning mode 1: Manual seed 2: Seeded from DGPS 3: Seeded from RTKFixed
Latency	u2	0.0001 s	65535	Time elapsed between the time of applicability of the position fix and the generation of this SBF block by the receiver. This time includes the receiver processing time, but not the communication latency.
HAccuracy	u2	0.01 m	65535	2DRMS horizontal accuracy: twice the root-mean-square of the horizontal distance error. The horizontal distance between the true position and the computed position is expected to be lower than $H_{Accuracy}$ with a probability of at least 95%. The value is clipped to $65534 = 655.34m$
VAccuracy	u2	0.01 m	65535	2-sigma vertical accuracy. The vertical distance between the true position and the computed position is expected to be lower than $V_{Accuracy}$ with a probability of at least 95%. The value is clipped to $65534 = 655.34m$.
Misc	u1			Bit field containing miscellaneous flags: Bit 0: In DGNSS or RTK mode, set if the baseline points to the base station ARP. Unset if it points to the antenna phase center, or if unknown. Bit 1: Set if the phase center offset is compensated for at the rover, unset if not or unknown. Bit 2: Proprietary. Bit 3: Proprietary. Bits 4-5: Proprietary. Bits 6-7: Flag indicating whether the marker position reported in this block is also the ARP position (i.e. whether the ARP-to-marker offset provided with the <code>setAntennaOffset</code> command is zero or not) 0: Unknown 1: The ARP-to-marker offset is zero 2: The ARP-to-marker offset is not zero
Padding	u1[.]			Padding bytes, see 4.1.5

Rev 2

ExtEventPVTGeodetic	Number: 4038 "OnChange" interval: each time an external event is detected
---------------------	--

This block contains the position, velocity and time (PVT) solution applicable at the time of an external event, in an ellipsoidal coordinate system.

This block has the same structure and description as the `PVTGeodetic` block, except that the `TOW` and `WNC` fields refer to the time at which the electrical transition on the event pin has been detected (with a millisecond resolution), and that the position is computed at the event time, taking into account a possible user-defined delay set by the **setEventParameters** command.

A user needing the sub-millisecond part of the event time must refer to the `Offset` field of the corresponding `ExtEvent` block. The corresponding `ExtEvent` block is the last of the `ExtEvent` blocks having been output by the receiver.

Parameter	Type	Units	Do-Not-Use	Description
Sync1	c1			Block Header, see 4.1.1
Sync2	c1			
CRC	u2			
ID	u2			
Length	u2	1 byte		
TOW	u4	0.001 s	4294967295	External time stamp, see 4.1.3
WNc	u2	1 week	65535	
Mode	u1			Bit field indicating the PVT mode, as follows: Bits 0-3: type of PVT solution: 0: No PVT available (the <code>ERROR</code> field indicates the cause of the absence of the PVT solution) 1: Stand-Alone PVT 2: Differential PVT 3: Fixed location 4: RTK with fixed ambiguities 5: RTK with float ambiguities 6: SBAS aided PVT 7: moving-base RTK with fixed ambiguities 8: moving-base RTK with float ambiguities 10: Precise Point Positioning (PPP) 12: Reserved Bits 4-5: Reserved Bit 6: Set if the user has entered the command <code>setPVTMode, Static, auto</code> and the receiver is still in the process of determining its fixed position. Bit 7: 2D/3D flag: set in 2D mode (height assumed constant and not computed).
Error	u1			PVT error code. The following values are defined: 0: No Error 1: Not enough measurements 2: Not enough ephemerides available 3: DOP too large (larger than 15) 4: Sum of squared residuals too large 5: No convergence 6: Not enough measurements after outlier rejection 7: Position output prohibited due to export laws 8: Not enough differential corrections available 9: Base station coordinates unavailable 10: Ambiguities not fixed and user requested to only output RTK-fixed positions
Latitude	f8	1 rad	$-2 \cdot 10^{10}$	Latitude, from $-\pi/2$ to $+\pi/2$, positive North of Equator
Longitude	f8	1 rad	$-2 \cdot 10^{10}$	Longitude, from $-\pi$ to $+\pi$, positive East of Greenwich
Height	f8	1 m	$-2 \cdot 10^{10}$	Ellipsoidal height (with respect to the ellipsoid specified by <code>Datum</code>)
Undulation	f4	1 m	$-2 \cdot 10^{10}$	Geoid undulation. See the <code>setGeoidUndulation</code> command.
Vn	f4	1 m / s	$-2 \cdot 10^{10}$	Not applicable
Ve	f4	1 m / s	$-2 \cdot 10^{10}$	Not applicable
Vu	f4	1 m / s	$-2 \cdot 10^{10}$	Not applicable

COG	f4	1 degree	$-2 \cdot 10^{10}$	Course over ground: this is defined as the angle of the vehicle with respect to the local level North, ranging from 0 to 360, and increasing towards east. Set to the Do-Not-Use value when the speed is lower than 0.1m/s.
RxClkBias	f8	1 ms	$-2 \cdot 10^{10}$	Receiver clock bias relative to the GNSS system time reported in the <code>TimeSystem</code> field. Positive when the receiver time is ahead of the system time. To transfer the receiver time to the system time, use: $t_{GPS/GST} = t_{rx} - RxClkBias$
RxClkDrift	f4	1 ppm	$-2 \cdot 10^{10}$	Receiver clock drift relative to the GNSS system time (relative frequency error). Positive when the receiver clock runs faster than the system time.
TimeSystem	u1		255	Time system of which the offset is provided in this sub-block: 0: GPS time 1: Galileo time 3: GLONASS time 4: BeiDou time
Datum	u1		255	This field defines in which datum the coordinates are expressed: 0: WGS84/ITRS 19: Datum equal to that used by the DGNSS/RTK base station 30: ETRS89 (ETRF2000 realization) 31: NAD83(2011), North American Datum (2011) 32: NAD83(PA11), North American Datum, Pacific plate (2011) 33: NAD83(MA11), North American Datum, Marianas plate (2011) 34: GDA94(2010), Geocentric Datum of Australia (2010) 35: GDA2020, Geocentric Datum of Australia 2020 250: First user-defined datum 251: Second user-defined datum
NrSV	u1		255	Total number of satellites used in the PVT computation.
WACorrInfo	u1		0	Bit field providing information about which wide area corrections have been applied: Bit 0: set if orbit and satellite clock correction information is used Bit 1: set if range correction information is used Bit 2: set if ionospheric information is used Bit 3: set if orbit accuracy information is used (UERE/SISA) Bit 4: set if DO229 Precision Approach mode is active Bits 5-7: Reserved
ReferenceID	u2		65535	This field indicates the reference ID of the differential information used. In case of DGPS or RTK operation, this field is to be interpreted as the base station identifier. In SBAS operation, this field is to be interpreted as the PRN of the geostationary satellite used (from 120 to 158). If multiple base stations or multiple geostationary satellites are used the value is set to 65534.
MeanCorrAge	u2	0.01 s	65535	In case of DGPS or RTK, this field is the mean age of the differential corrections. In case of SBAS operation, this field is the mean age of the 'fast corrections' provided by the SBAS satellites.
SignalInfo	u4		0	Bit field indicating the type of GNSS signals having been used in the PVT computations. If a bit i is set, the signal type having index i has been used. The signal numbers are listed in section 4.1.10. Bit 0 (GPS-C/A) is the LSB of <code>SignalInfo</code> .

Rev 1

AlertFlag	u1		0	Bit field indicating integrity related information: Bits 0-1: RAIM integrity flag: 0: RAIM not active (integrity not monitored) 1: RAIM integrity test successful 2: RAIM integrity test failed 3: Reserved Bit 2: set if integrity has failed as per Galileo HPCA (HMI Probability Computation Algorithm) Bit 3: set if Galileo ionospheric storm flag is active Bit 4: Reserved Bits 5-7: Reserved
NrBases	u1		0	Number of base stations used in the PVT computation.
PPPInfo	u2	1 s	0	Bit field containing PPP-related information: Bits 0-11: Age of the last seed, in seconds. The age is clipped to 4091s. This field must be ignored when the seed type is 0 (see bits 13-15 below). Bit 12: Reserved Bits 13-15: Type of last seed: 0: Not seeded or not in PPP positioning mode 1: Manual seed 2: Seeded from DGPS 3: Seeded from RTKFixed
Latency	u2	0.0001 s	65535	Time elapsed between the time of applicability of the position fix and the generation of this SBF block by the receiver. This time includes the receiver processing time, but not the communication latency.
HAccuracy	u2	0.01 m	65535	2DRMS horizontal accuracy: twice the root-mean-square of the horizontal distance error. The horizontal distance between the true position and the computed position is expected to be lower than $H_{Accuracy}$ with a probability of at least 95%. The value is clipped to $65534 = 655.34m$
VAccuracy	u2	0.01 m	65535	2-sigma vertical accuracy. The vertical distance between the true position and the computed position is expected to be lower than $V_{Accuracy}$ with a probability of at least 95%. The value is clipped to $65534 = 655.34m$.
Misc	u1			Bit field containing miscellaneous flags: Bit 0: In DGNSS or RTK mode, set if the baseline points to the base station ARP. Unset if it points to the antenna phase center, or if unknown. Bit 1: Set if the phase center offset is compensated for at the rover, unset if not or unknown. Bit 2: Proprietary. Bit 3: Proprietary. Bits 4-5: Proprietary. Bits 6-7: Flag indicating whether the marker position reported in this block is also the ARP position (i.e. whether the ARP-to-marker offset provided with the <code>setAntennaOffset</code> command is zero or not) 0: Unknown 1: The ARP-to-marker offset is zero 2: The ARP-to-marker offset is not zero
Padding	u1[.]			Padding bytes, see 4.1.5

Rev 2

<code>ExtEventBaseVectGeod</code>	Number: 4217 "OnChange" interval: each time an external event is detected
-----------------------------------	--

...

Parameter	Type	Units	Do-Not-Use	Description
Sync1	c1			Block Header, see 4.1.1
Sync2	c1			
CRC	u2			
ID	u2			
Length	u2	1 byte		External time stamp, see 4.1.3
TOW	u4	0.001 s	4294967295	
WNc	u2	1 week	65535	
N	u1			Number of baselines for which relative position, velocity and direction are provided in this SBF block, i.e. number of <code>ExtEventVectorInfoGeod</code> sub-blocks. If N is 0, there are no baseline available for this epoch.
SBLength	u1	1 byte		Length of one sub-block
<code>ExtEventVectorInfoGeod</code>		<i>A succession of N <code>ExtEventVectorInfoGeod</code> sub-blocks, see definition below</i>
Padding	u1[.]			Padding bytes, see 4.1.5

ExtEventVectorInfoGeod sub-block definition:

Parameter	Type	Units	Do-Not-Use	Description
NrSV	u1			Number of satellites for which corrections are available from the base station identified by the <code>ReferenceID</code> field.
Error	u1			PVT error code. The following values are defined: 0: No Error 1: Not enough measurements 2: Not enough ephemerides available 3: DOP too large (larger than 15) 4: Sum of squared residuals too large 5: No convergence 6: Not enough measurements after outlier rejection 7: Position output prohibited due to export laws 8: Not enough differential corrections available 9: Base station coordinates unavailable 10: Ambiguities not fixed and user requested to only output RTK-fixed positions
Mode	u1			Bit field indicating the PVT mode, as follows: Bits 0-3: type of PVT solution: 0: No PVT available (the <code>Error</code> field indicates the cause of the absence of the PVT solution) 1: Stand-Alone PVT 2: Differential PVT 3: Fixed location 4: RTK with fixed ambiguities 5: RTK with float ambiguities 6: SBAS aided PVT 7: moving-base RTK with fixed ambiguities 8: moving-base RTK with float ambiguities 10: Precise Point Positioning (PPP) 12: Reserved Bits 4-5: Reserved Bit 6: Set if the user has entered the command <code>setPVTMode,Static,auto</code> and the receiver is still in the process of determining its fixed position. Bit 7: 2D/3D flag: set in 2D mode (height assumed constant and not computed).
Misc	u1			Bit field containing miscellaneous flags: Bit 0: Set if the baseline points to the base station ARP. Unset if it points to the antenna phase center, or if unknown. Bit 1: Set if the phase center offset is compensated for at the rover (i.e. the baseline starts from the antenna ARP), unset if not or unknown. Bit 2: Proprietary. Bit 3: Proprietary. Bits 4-5: Proprietary. Bits 6-7: Reserved
DeltaEast	f8	1 m	$-2 \cdot 10^{10}$	East baseline component (from rover to base)
DeltaNorth	f8	1 m	$-2 \cdot 10^{10}$	North baseline component (from rover to base)
DeltaUp	f8	1 m	$-2 \cdot 10^{10}$	Up baseline component (from rover to base)

DeltaVe	f4	1 m / s	$-2 \cdot 10^{10}$	East velocity of base with respect to rover
DeltaVn	f4	1 m / s	$-2 \cdot 10^{10}$	North velocity of base with respect to rover
DeltaVu	f4	1 m / s	$-2 \cdot 10^{10}$	Up velocity of base with respect to rover
Azimuth	u2	0.01 degrees	65535	Azimuth of the base station (from 0 to 360°, increasing towards east)
Elevation	i2	0.01 degrees	-32768	Elevation of the base station (from -90° to 90°)
ReferenceID	u2			Base station ID
CorrAge	u2	0.01 s	65535	Age of the oldest differential correction used for this baseline computation.
SignalInfo	u4		0	Bit field indicating the GNSS signals for which differential corrections are available from the base station identified by ReferenceID. If bit <i>i</i> is set, corrections for the signal type having index <i>i</i> are available. The signal numbers are listed in section 4.1.10. Bit 0 (GPS-C/A) is the LSB of SignalInfo.
Padding	u1[.]			Padding bytes, see 4.1.5

ExtEventAttEuler	Number: 4237 "OnChange" interval: each time an external event is detected
------------------	--

This block contains the Euler angles (pitch, roll and heading) applicable at the time of an external event.

This block has the same structure and description as the AttEuler block, except that the TOW and WNC fields refer to the time at which the electrical transition on the event pin has been detected (with a millisecond resolution), and that the position is computed at the event time, taking into account a possible user-defined delay set by the **setEventParameters** command.

A user needing the sub-millisecond part of the event time must refer to the Offset field of the corresponding ExtEvent block. The corresponding ExtEvent block is the last of the ExtEvent blocks having been output by the receiver.

Parameter	Type	Units	Do-Not-Use	Description
Sync1	c1			Block Header, see 4.1.1
Sync2	c1			
CRC	u2			
ID	u2			
Length	u2	1 byte		
TOW	u4	0.001 s	4294967295	External time stamp, see 4.1.3
WNC	u2	1 week	65535	
NrSV	u1		255	The average over all antennas of the number of satellites currently included in the attitude calculations.
Error	u1			Bit field providing error information. For each antenna baseline, two bits are used to provide error information: Bits 0-1: Error code for Main-Aux1 baseline: 0: No error 1: Not enough measurements 2: Reserved 3: Reserved Bits 2-3: Error code for Main-Aux2 baseline, same definition as bit 0-1. Bits 4-6: Reserved Bit 7: Set when GNSS-based attitude not requested by user. In that case, the other bits are all zero.
Mode	u2			Attitude mode code: 0: No attitude 1: Heading, pitch (roll = 0), aux antenna positions obtained with float ambiguities 2: Heading, pitch (roll = 0), aux antenna positions obtained with fixed ambiguities 3: Heading, pitch, roll, aux antenna positions obtained with float ambiguities 4: Heading, pitch, roll, aux antenna positions obtained with fixed ambiguities
Reserved	u2			Reserved for future use, to be ignored by decoding software
Heading	f4	1 degree	$-2 \cdot 10^{10}$	Heading
Pitch	f4	1 degree	$-2 \cdot 10^{10}$	Pitch
Roll	f4	1 degree	$-2 \cdot 10^{10}$	Roll
PitchDot	f4	1 degree / s	$-2 \cdot 10^{10}$	Not applicable

RollDot	f4	1 degree / s	$-2 \cdot 10^{10}$	Not applicable
HeadingDot	f4	1 degree / s	$-2 \cdot 10^{10}$	Not applicable
Padding	u1[.]			Padding bytes, see 4.1.5

4.2.13 Differential Correction Blocks

DiffCorrIn	Number:	5919
	"OnChange" interval:	each time a RTCM or CMR message is received

The `DiffCorrIn` block contains incoming RTCM or CMR messages. The length of the block depends on the message type and contents.

Parameter	Type	Units	Do-Not-Use	Description
Sync1	c1			Block Header, see 4.1.1
Sync2	c1			
CRC	u2			
ID	u2			
Length	u2	1 byte		
TOW	u4	0.001 s	4294967295	Receiver time stamp, see 4.1.3
WNc	u2	1 week	65535	
Mode	u1			0: RTCMv2 1: CMRv2 2: RTCMv3 3: RTCMV (a proprietary variant of RTCM2) 4: SPARTN 5: Reserved
Source	u1		255	Indicates the receiver connection from which the message has been received: 0: COM1 1: COM2 2: COM3 3: COM4 4: USB1 5: USB2 6: IP connection 7: SBF file 8: L-Band (message decoded by the built-in L-band demodulator) 9: NTRIP 10: OTG1 11: OTG2 12: Bluetooth 15: UHF modem 16: IPR connection 17: Direct call port 18: IPS connection
If the Mode field is 0 then this field is available:				
RTCM2Words	u4[M]			30-bit words of the RTCM2 message. The Data Word Length (number of 32 bit words) is variable and depends on the RTCM2 message contents. It can be computed by the following piece of C code: $N = 2 + ((RTCM2Words[1] \gg 9) \& 0x1f);$ N can range from 2 to 33. The first two words are the RTCM2 message header and they are always present. Each of the words is organized as follows: Bits 0-5: 6 parity bits. They are provided for the sake of completeness. Parity doesn't need to be checked, since the DiffCorrIn block only contains valid words. Bits 6-29: 24 information-containing bits of the word. The first received bit is the MSB. Bits 30-31: bit 0 and 1 of the preceding word
If the Mode field is 1 then this field is available:				
CMRMessage	u1[M]			N depends on the CMR message type.
If the Mode field is 2 then this field is available:				
RTCM3Message	u1[M]			N depends on the RTCM 3 message type.

If the Mode field is 3 then this field is available:			
RTCMVMessage	u1[M]		N depends on the RTCMV message type.
Padding	u1[.]		Padding bytes, see 4.1.5

<code>BaseStation</code>	Number: 5949 "OnChange" interval: block generated each time a differential correction message related to the base station coordinates is received
--------------------------	--

The `BaseStation` block contains the ECEF coordinates of the base station the receiver is currently connected to. This block helps users accessing the base station coordinates via SBF instead of having to decode the specific differential correction message (see the `DiffCorrIn` SBF block above).

The interpretation to give to the X, Y, Z ECEF coordinates is dependent on the value of the `Source` field:

Value of Source	Interpretation of X, Y, Z
0, 4 or 10	Coordinate of the L1 phase center
2 or 8	Antenna reference point
9	Proprietary

Parameter	Type	Units	Do-Not-Use	Description
<code>Sync1</code>	c1			Block Header, see 4.1.1
<code>Sync2</code>	c1			
<code>CRC</code>	u2			
<code>ID</code>	u2			
<code>Length</code>	u2	1 byte		
<code>TOW</code>	u4	0.001 s	4294967295	Receiver time stamp, see 4.1.3
<code>WNc</code>	u2	1 week	65535	
<code>BaseStationID</code>	u2			The base station ID
<code>BaseType</code>	u1			Base station type: 0: Fixed 1: Moving (reserved for future use) 255: Unknown
<code>Source</code>	u1			Source of the base station coordinates: 0: RTCM 2.x (Msg 3) 2: RTCM 2.x (Msg 24) 4: CMR 2.x (Msg 1) 8: RTCM 3.x (Msg 1005 or 1006) 9: RTCMV (Msg 3) 10: CMR+ (Type 2)
<code>Datum</code>	u1		255	Not applicable
<code>Reserved</code>	u1			Reserved for future use, to be ignored by decoding software
<code>X</code>	f8	1 m		Antenna X coordinate expressed in the datum specified by the <code>Datum</code> field
<code>Y</code>	f8	1 m		Antenna Y coordinate
<code>Z</code>	f8	1 m		Antenna Z coordinate
<code>Padding</code>	u1[.]			Padding bytes, see 4.1.5

RTCMDatum	Number: 4049 "OnChange" interval: block generated each time a set of transformation parameters is received
-----------	---

This block reports the source and target datum names as transmitted in RTCM 3.x message types 1021 or 1022. It also reports the corresponding height and quality indicators.

If a service provider only sends out message types 1021 or 1022, this block is transmitted immediately after reception of MT1021 or MT1022. If message types 1023 or 1024 are also sent out, this block is transmitted after the reception of these messages and the `QualityInd` field is set accordingly.

Parameter	Type	Units	Do-Not-Use	Description
Sync1	c1			Block Header, see 4.1.1
Sync2	c1			
CRC	u2			
ID	u2			
Length	u2	1 byte		
TOW	u4	0.001 s	4294967295	Receiver time stamp, see 4.1.3
WNc	u2	1 week	65535	
SourceCRS	c1[32]			Name of the source Coordinate Reference System, right-padded with zeros.
TargetCRS	c1[32]			Name of the target Coordinate Reference System, right-padded with zeros.
Datum	u1			See the <code>Datum</code> field in the <code>PosLocal</code> and <code>PosProjected</code> SBF blocks. Datum is set to 255 if this <code>SourceCRS/TargetCRS</code> pair is currently not used by the receiver.
HeightType	u1			Height Indicator field from MT1021 and MT1022. This field indicates how to interpret the height reported in the <code>PosLocal</code> and the <code>PosProjected</code> SBF blocks: 0: Geometrical height 1: Physical height (height definition in target CRS) 2: Physical height (height definition in source CRS)
QualityInd	u1			Bit field indicating the maximum approximation error after applying the transformation: Bits 0-3: horizontal quality indicator: 0: Unknown quality 1: Quality better than 21 mm (from MT1021/1022) 2: Quality 21 to 50 mm (from MT1021/1022) 3: Quality 51 to 200 mm (from MT1021/1022) 4: Quality 201 to 500 mm (from MT1021/1022) 5: Quality 501 to 2000 mm (from MT1021/1022) 6: Quality 2001 to 5000 mm (from MT1021/1022) 7: Quality worse than 5001 mm (from MT1021/1022) 9: Quality 0 to 10 mm (from MT1023/1024) 10: Quality 11 to 20 mm (from MT1023/1024) 11: Quality 21 to 50 mm (from MT1023/1024) 12: Quality 51 to 100 mm (from MT1023/1024) 13: Quality 101 to 200 mm (from MT1023/1024) 14: Quality 201 to 500 mm (from MT1023/1024) 15: Quality worse than 501 mm (from MT1023/1024) Bits 4-7: vertical quality indicator, same definition as bits 0-3.
Padding	u1[.]			Padding bytes, see 4.1.5

4.2.14 L-Band Demodulator Blocks

LBandTrackerStatus	Number: 4201 "OnChange" interval: 1s
--------------------	---

The `LBandTrackerStatus` block provides general information on the tracking status of the L-band signals.

Parameter	Type	Units	Do-Not-Use	Description
Sync1	c1			Block Header, see 4.1.1
Sync2	c1			
CRC	u2			
ID	u2			
Length	u2	1 byte		
TOW	u4	0.001 s	4294967295	Receiver time stamp, see 4.1.3
WNc	u2	1 week	65535	
N	u1			Number of L-band trackers for which data is provided in this SBF block, i.e. number of <code>TrackData</code> sub-blocks.
SBLength	u1	1 byte		Length of one sub-block
<i>TrackData</i>		<i>A succession of N TrackData sub-blocks, see definition below</i>
Padding	u1[.]			Padding bytes, see 4.1.5

TrackData sub-block definition:

Parameter	Type	Units	Do-Not-Use	Description
Frequency	u4	1 Hz	0	Nominal frequency of the beam for which data is provided in this sub-block.
Baudrate	u2	1 baud	0	Baudrate of the beam
ServiceID	u2			Service ID of the beam. Set to 0 for the LBAS1 beam. Set to 1 for the LBAS2 beam when received through an NTRIP connection. This field must be ignored if the <i>Status</i> field is set to anything else than 3 (Locked).
FreqOffset	f4	1 Hz	$-2 \cdot 10^{10}$	Frequency offset of the demodulator, if available
CN0	u2	0.01 dB-Hz	0	Current C/N ₀ value
AvgPower	i2	0.01 dB	-32768	Not applicable.
AGCGain	i1	1 dB	-128	Not applicable.
Mode	u1			Current operation mode: 0: normal
Status	u1			Current status: 0: Idle 1: Search 2: FrameSearch 3: Locked
Rev 2 SVID	u1			Satellite ID, see 4.1.9
Rev 1 LockTime	u2	1 s		Lock time to the L-band signal, clipped to 65535 seconds.
Rev 3 Source	u1			L-band tracking module: 0: Unknown 1: Internal 2: LBR board 3: NTRIP. L-band data received over NTRIP. In that case, the other fields in this sub-block are not applicable and set to their Do-Not-Use value.
Padding	u1[.]			Padding bytes, see 4.1.5

LBandBeams	Number: 4204
	"OnChange" interval: Block generated each time beam status data is decoded

This block contains the name, longitude and beam frequency of the L-band geostationary satellites known by the receiver.

Parameter	Type	Units	Do-Not-Use	Description
Sync1	c1			Block Header, see 4.1.1
Sync2	c1			
CRC	u2			
ID	u2			
Length	u2	1 byte		
TOW	u4	0.001 s	4294967295	Receiver time stamp, see 4.1.3
WNc	u2	1 week	65535	
N	u1			Number of L-band beams for which data is provided in this SBF block, i.e. number of <i>BeamInfo</i> sub-blocks.
SBLength	u1	1 byte		Length of one sub-block
<i>BeamInfo</i>		<i>A succession of N BeamInfo sub-blocks, see definition below</i>
Padding	u1[.]			Padding bytes, see 4.1.5

BeamInfo sub-block definition:

Parameter	Type	Units	Do-Not-Use	Description
SVID	u1			SVID associated to the satellite for which information is provided in this sub-block. SVID ranges from 107 to 119. See also section 4.1.9.
SatName	c1[9]			Satellite Name, right padded with zeros
SatLongitude	i2	0.01 degrees	-32768	Satellite Longitude (positive east of Greenwich)
BeamFreq	u4	1 Hz	0	L-band beam center frequency
Padding	u1[.]			Padding bytes, see 4.1.5

4.2.15 Status Blocks

ChannelStatus	Number: 4013
	"OnChange" interval: default PVT output rate (see 4.1.8)

This block describes the current satellite allocation and tracking status of the active receiver channels. Active channels are channels to which a satellite has been allocated.

This block uses a two-level sub-block structure analogous to that of the `MeasEpoch` block. For each active channel, a `ChannelSatInfo` sub-block contains all satellite-dependent information such as health, azimuth and elevation. Each of these sub-blocks contains N_2 `ChannelStateInfo` sub-blocks, N_2 being the number of active antennas in a given channel (for single-antenna receivers, N_2 is one). The `ChannelStateInfo` reports information such as the tracking status and PVT usage of a given signal type tracked on a given antenna.

Inactive channels are not contained in the `ChannelStatus` block.

Health, tracking and PVT status fields are available for each satellite. These status fields consist of a sequence of up to 8 two-bit fields. Each 2-bit field contains the status of one of the signals transmitted by the satellite. The position of the 2 bits corresponding to a given signal is dependent on the constellation, but is otherwise fixed. It is indicated in the tables below.

GPS:

Reserved		Reserved		L1C		L5		L2C		P2(Y)		P1(Y)		L1CA	
15	14	13	12	11	10	9	8	7	6	5	4	3	2	1	0

GLONASS:

Reserved		Reserved		Reserved		L3		L2CA		L2P		L1P		L1CA	
15	14	13	12	11	10	9	8	7	6	5	4	3	2	1	0

Galileo:

Reserved		E5-AltBOC		E5b		E5a		E6BC		E6A		L1BC		L1A	
15	14	13	12	11	10	9	8	7	6	5	4	3	2	1	0

SBAS:

Reserved		Reserved		Reserved		Reserved		Reserved		Reserved		L5		L1	
15	14	13	12	11	10	9	8	7	6	5	4	3	2	1	0

BeiDou:

Reserved		Reserved		B2b		B2a		B1C		B3I		B2I		B1I	
15	14	13	12	11	10	9	8	7	6	5	4	3	2	1	0

QZSS:

Reserved		Reserved		L1S		L1C		L6		L5		L2C		L1CA	
15	14	13	12	11	10	9	8	7	6	5	4	3	2	1	0

NavIC/IRNSS:

Reserved		Reserved		Reserved		Reserved		Reserved		Reserved		Reserved		L5	
15	14	13	12	11	10	9	8	7	6	5	4	3	2	1	0

Parameter	Type	Units	Do-Not-Use	Description
Sync1	c1			Block Header, see 4.1.1
Sync2	c1			
CRC	u2			
ID	u2			
Length	u2	1 byte		
TOW	u4	0.001 s	4294967295	Receiver time stamp, see 4.1.3
WNc	u2	1 week	65535	
N	u1			Number of channels for which status are provided in this SBF block, i.e. number of <code>ChannelSatInfo</code> sub-blocks. If N is 0, there are no active channels available for this epoch.
SB1Length	u1	1 byte		Length of a <code>ChannelSatInfo</code> sub-block, excluding the nested <code>ChannelStateInfo</code> sub-blocks
SB2Length	u1	1 byte		Length of a <code>ChannelStateInfo</code> sub-block
Reserved	u1[3]			Reserved for future use, to be ignored by decoding software
<i>SatInfo</i>		<i>A succession of N ChannelSatInfo sub-blocks, see definition below</i>
Padding	u1[.]			Padding bytes, see 4.1.5

ChannelSatInfo sub-block definition:

Parameter	Type	Units	Do-Not-Use	Description
SVID	u1			Satellite ID, see 4.1.9
FreqNr	u1		0	For GLONASS FDMA signals, this is the frequency number, with an offset of 8. It ranges from 1 (corresponding to an actual frequency number of -7) to 21 (corresponding to an actual frequency number of 13). Otherwise, FreqNr is reserved and must be ignored by the decoding software.
Reserved1	u1[2]			Reserved for future use, to be ignored by decoding software
Azimuth/RiseSet	u2	1 degree	511 3	bit field: Bits 0-8: Azimuth [0,359]. 0 is North, and Azimuth increases towards East. Bits 9-13: Reserved Bits 14-15: Rise/Set Indicator: 0: Satellite setting 1: Satellite rising 3: Elevation rate unknown
HealthStatus	u2			Sequence of 2-bit health status fields, each of them taking one of the following values: 0 : health unknown, or not applicable 1 : healthy 3 : unhealthy The 2-bit health status is a condensed version of the health status as sent by the satellite. For SBAS, the health status is set from the almanac data (MT17).
Elevation	i1	1 degree	-128	Elevation [-90,90] relative to local horizontal plane
N2	u1			Number of <code>ChannelStateInfo</code> blocks following this <code>ChannelSatInfo</code> block. There is one <code>ChannelStateInfo</code> sub-block per antenna.
RxChannel	u1			Channel number, see section 4.1.11.
Reserved2	u1			Reserved for future use, to be ignored by decoding software
Padding	u1[.]			Padding bytes, see 4.1.5

<i>StateInfo</i>	A succession of <i>N2 ChannelStateInfo</i> sub-blocks, see definition below
------------------	-----	-----	---

ChannelStateInfo sub-block definition:

Parameter	Type	Units	Description
Antenna	u1		Antenna number (0 for main antenna)
Reserved	u1		Reserved for future use, to be ignored by decoding software
TrackingStatus	u2		Sequence of 2-bit tracking status fields, each of them taking one of the following values: 0: idle or not applicable 1: Search 2: Sync 3: Tracking
PVTStatus	u2		Sequence of 2-bit PVT status fields, each of them taking one of the following values: 0: not used 1: waiting for ephemeris 2: used 3: rejected
PVTInfo	u2		Internal info
Padding	u1[.]		Padding bytes, see 4.1.5

ReceiverStatus	Number: 4014 "OnChange" interval: 1s
----------------	---

The `ReceiverStatus` block provides general information on the status of the receiver.

Parameter	Type	Units	Do-Not-Use	Description
Sync1	c1			Block Header, see 4.1.1
Sync2	c1			
CRC	u2			
ID	u2			
Length	u2	1 byte		
TOW	u4	0.001 s	4294967295	Receiver time stamp, see 4.1.3
WNc	u2	1 week	65535	
CPUload	u1	1 %	255	Load on the receiver's CPU. The load should stay below 80% in normal operation. Higher loads might result in data loss.
ExtError	u1			Bit field reporting external errors, i.e. errors detected in external data. Upon detection of an error, the corresponding bit is set for a duration of one second, and then resets. Bit 0: SISERROR: set if a violation of the signal-in-space ICD has been detected for at least one satellite while that satellite is reported as healthy. Use the command <code>"lif, SisError"</code> for details. Bit 1: DIFFCORRERROR: set when an anomaly has been detected in an incoming differential correction stream, causing the receiver to fail to decode the corrections. Use the command <code>"lif, DiffCorrError"</code> for details. Bit 2: EXTSENSORERROR: set when a malfunction has been detected on at least one of the external sensors connected to the receiver. Use the command <code>"lif, ExtSensorError"</code> for details. Bit 3: SETUPERROR: set when a configuration/setup error has been detected. An example of such error is when a remote NTRIP Caster is not reachable. Use the command <code>"lif, SetupError"</code> for details. Bits 4-7: Reserved
UpTime	u4	1 s		Number of seconds elapsed since the start-up of the receiver, or since the last reset.

RxState	u4		<p>Bit field indicating the status of key components of the receiver:</p> <p>Bit 0: Reserved</p> <p>Bit 1: ACTIVEANTENNA: this bit is set when an active antenna is sensed at the main antenna connector. This functionality is only available on certain receiver models.</p> <p>Bit 2: EXT_FREQ: this bit is set if an external frequency reference is detected at the 10 MHz input, and cleared if the receiver uses its own internal clock.</p> <p>Bit 3: EXT_TIME: this bit is set if a pulse has been detected on the TimeSync input.</p> <p>Bit 4: WNSET: see corresponding bit in the SyncLevel field of the ReceiverTime block.</p> <p>Bit 5: TOWSET: see corresponding bit in the SyncLevel field of the ReceiverTime block.</p> <p>Bit 6: FINETIME: see corresponding bit in the SyncLevel field of the ReceiverTime block.</p> <p>Bit 7: INTERNALDISK_ACTIVITY: this bit is set for one second each time data is logged to the internal disk (DSK1). If the logging rate is larger than 1 Hz, set continuously.</p> <p>Bit 8: INTERNALDISK_FULL: this bit is set when the internal disk (DSK1) is full. A disk is full when it is filled to 95% of its total capacity.</p> <p>Bit 9: INTERNALDISK_MOUNTED: this bit is set when the internal disk (DSK1) is mounted.</p> <p>Bit 10: INT_ANT: this bit is set when the GNSS RF signal is taken from the internal antenna input, and cleared when it comes from the external antenna input (only applicable on receiver models featuring an internal antenna input).</p> <p>Bit 11: REFOUT_LOCKED: if set, the 10-MHz frequency provided at the REF OUT connector is locked to GNSS time. Otherwise it is free-running.</p> <p>Bit 12: LBAND_ANT: this bit is set when the L-band signal is tracked from the dedicated L-band antenna, and cleared when it is tracked from the same antenna as the GNSS signals, or when the receiver does not support L-band tracking.</p> <p>Bit 13: EXTERNALDISK_ACTIVITY: this bit is set for one second each time data is logged to the external disk (DSK2). If the logging rate is larger than 1 Hz, set continuously.</p> <p>Bit 14: EXTERNALDISK_FULL: this bit is set when the external disk (DSK2) is full. A disk is full when it is filled to 95% of its total capacity.</p> <p>Bit 15: EXTERNALDISK_MOUNTED: this bit is set when the external disk (DSK2) is mounted.</p> <p>Bit 16: PPS_IN_CAL: this bit is set when PPS IN delay calibration is ongoing. Only applicable to PolARx5TR receivers.</p> <p>Bit 17: DIFFCORR_IN: this bit is set for one second each time differential corrections are decoded. If the input rate is larger than 1 Hz, set continuously.</p> <p>Bit 18: INTERNET: this bit is set when the receiver has internet access. If not set, there is either no internet access, or the receiver could not reliably determine the status.</p> <p>Bits 19-31: Reserved</p>
---------	----	--	--

Rev 1

RxError	u4			<p>Bit field indicating whether an error occurred previously. If this field is not equal to zero, at least one error has been detected.</p> <p>Bit 0: Reserved</p> <p>Bit 1: Reserved</p> <p>Bit 2: Reserved</p> <p>Bit 3: SOFTWARE: set upon detection of a software warning or error. This bit is reset by the command "lif, error".</p> <p>Bit 4: WATCHDOG: set when the watchdog expired at least once since the last power-on.</p> <p>Bit 5: ANTENNA: set when antenna overcurrent condition is detected.</p> <p>Bit 6: CONGESTION: set when an output data congestion has been detected on at least one of the communication ports of the receiver during the last second.</p> <p>Bit 7: Reserved</p> <p>Bit 8: MISSEDEVENT: set when an external event congestion has been detected during the last second. It indicates that the receiver is receiving too many events on its EVENTx pins.</p> <p>Bit 9: CPUOVERLOAD: set when the CPU load is larger than 90%.</p> <p>Bit 10: INVALIDCONFIG: set if one or more configuration file (e.g. permissions) is invalid or absent.</p> <p>Bit 11: OUTOFGEOFENCE: set if the receiver is currently out of its permitted region of operation (geofencing).</p> <p>Bit 12: Reserved</p> <p>Bit 13: Reserved</p> <p>Bit 14: Reserved</p> <p>Bit 15: Reserved</p> <p>Bit 16: Reserved</p> <p>Bits 17-31: Reserved</p>
N	u1			Number of AGCState sub-blocks this block contains.
SBLength	u1	1 byte		Length of a AGCState sub-block.
CmdCount	u1		0	Command cyclic counter, incremented each time a command is entered that changes the receiver configuration. After the counter has reached 255, it resets to 1.
Temperature	u1	1 °C	0	Not applicable.
AGCState		A succession of N AGCState sub-blocks, see definition below
Padding	u1[.]			Padding bytes, see 4.1.5

AGCState sub-block definition:

Parameter	Type	Units	Do-Not-Use	Description
FrontEndID	u1			Bit field indicating the frontend code and antenna ID: Bits 0-4: frontend code: 0: GPSL1/E1 1: GLOL1 2: E6 3: GPSL2 4: GLOL2 5: L5/E5a 6: E5b/B2I 7: E5(a+b) 8: Combined GPS/GLONASS/SBAS/Galileo L1 9: Combined GPS/GLONASS L2 10: MSS/L-band 11: B1I 12: B3I 13: S-band Bits 5-7: Antenna ID: 0 for main, 1 for <i>Aux1</i> and 2 for <i>Aux2</i>
Gain	i1	1 dB	-128	AGC gain, in dB. The Do-Not-Use value is used to indicate that the frontend PLL is not locked.
SampleVar	u1		0	Normalized variance of the IF samples. The nominal value for this variance is 100.
BlankingStat	u1	1 %		Current percentage of samples being blanked by the pulse blanking unit. This field is always 0 for receiver without pulse blanking unit.
Padding	u1[.]			Padding bytes, see 4.1.5

SatVisibility	Number: 4012
	"OnChange" interval: 1s

This block contains the azimuth and elevation of all the satellites above the horizon for which the ephemeris or almanac is available.

Parameter	Type	Units	Do-Not-Use	Description
Sync1	c1			Block Header, see 4.1.1
Sync2	c1			
CRC	u2			
ID	u2			
Length	u2	1 byte		
TOW	u4	0.001 s	4294967295	Receiver time stamp, see 4.1.3
WNc	u2	1 week	65535	
N	u1			Number of satellites for which information is provided in this SBF block, i.e. number of <code>SatInfo</code> sub-blocks.
SBLength	u1	1 byte		Length of one <code>SatInfo</code> sub-block
<i>SatInfo</i>		<i>A succession of N SatInfo sub-blocks, see definition below</i>
Padding	u1[.]			Padding bytes, see 4.1.5

`SatInfo` sub-block definition:

Parameter	Type	Units	Do-Not-Use	Description
SVID	u1			Satellite ID, see 4.1.9
FreqNr	u1		0	For GLONASS FDMA signals, this is the frequency number, with an offset of 8. It ranges from 1 (corresponding to an actual frequency number of -7) to 21 (corresponding to an actual frequency number of 13). Otherwise, <code>FreqNr</code> is reserved and must be ignored by the decoding software.
Azimuth	u2	0.01 degrees	65535	Azimuth. 0 is North, and azimuth increases towards East.
Elevation	i2	0.01 degrees	-32768	Elevation relative to local horizontal plane.
RiseSet	u1			Rise/set indicator: 0: satellite setting 1: satellite rising 255: elevation rate unknown
SatelliteInfo	u1			Satellite visibility info based on: 1: almanac 2: ephemeris 255: unknown
Padding	u1[.]			Padding bytes, see 4.1.5

InputLink	Number:	4090
	"OnChange" interval:	1s

The `InputLink` block reports statistics of the number of bytes and messages received and accepted on each active connection descriptor.

Per connection descriptor, the receiver maintains two byte counters (`NrBytesReceived` and `NrBytesAccepted`) and two message counters (`NrMsgReceived` and `NrMsgAccepted`), which are reported in the sub-blocks. These counters provide useful information on the quality of the transmission link, and of the bandwidth efficiency.

These counters (as well as the age of the last message) are reset simultaneously on the following events:

- start-up of the receiver
- overflow of one of the counters
- change of input type
- deactivation of a connection descriptor, e.g. on disconnection of USB or IP ports.

There is one sub-block per connection descriptor for which statistics is available.

Parameter	Type	Units	Do-Not-Use	Description
Sync1	c1			Block Header, see 4.1.1
Sync2	c1			
CRC	u2			
ID	u2			
Length	u2	1 byte		
TOW	u4	0.001 s	4294967295	Receiver time stamp, see 4.1.3
WNc	u2	1 week	65535	
N	u1			Number of connection descriptors for which communication link statistics are included
SBLength	u1	1 byte		Length of one <code>InputStatsSub</code> sub-block.
<i>InputStats</i>		<i>A succession of N InputStatsSub sub-blocks, see definition below</i>
Padding	u1[.]			Padding bytes, see 4.1.5

InputStatsSub sub-block definition:

Parameter	Type	Units	Do-Not-Use	Description		
CD	u1			Identifier of the connection to which this information applies:		
				Value of CD	Connection type	Example
				0-31	COMx, with x=CD	1: COM1
				32-47	USBx, with x=CD-32	33: USB1
				48-63	OTGx, with x=CD-48	49: OTG1
				64-95	IPx, with x=CD-54	64:IP10
				96-127	DSKx, with x=CD-96	97:DSK1
				128-159	NTRx, with x=CD-128 (NTRIP connections)	129:NTR1
				160-191	IPSt, with x=CD-160 (IP server connections)	161:IPSt
				192	BT01 (Bluetooth connection)	
				193	BT02 (Bluetooth connection)	
				196	UHF1 (UHF Modem)	
				200-205	IPRx, with x=CD-200 (IP receive connections)	201:IPR1
				210	DCL1 (cellular data-call connection)	
				214	CAN1 (CAN stream interface)	
215-255	Reserved					

Type	u1			Type of data: 0: none 1: DaisyChain (includes "echo" messages) 32: CMD 33: SBF 34: AsciiDisplay (see setDataInOut command) 35: RINEX 36: CGGTTS 40: BINEX 64: NMEA 96: RTCMv2 97: RTCMv3 98: CMRv2 99: RTCMV (a proprietary variant of RTCMv2) 100: SPARTN 101: LBMP 110: raw LBAS1 from e.g. NTRIP 111: raw LBAS2 from e.g. NTRIP 118: raw LBAND data from Beam1 119: raw LBAND data from Beam2 120: raw LBAND data from Beam3 121: raw LBAND data from Beam4 128: Reserved 129: Reserved 130: Reserved 131: SBG (IMU sensor) 132: Reserved 133: Reserved 134: Reserved 135: Reserved 136: Reserved 137: ADIS 160: ASCIIIn
AgeOfLastMessage	u2	1 s	65535	Age of the last accepted message. If the age is older than 65534s, it is clipped to 65534s.
NrBytesReceived	u4	1 byte	4294967295	Total number of bytes received ⁽⁶⁾
NrBytesAccepted	u4	1 byte	4294967295	Total number of bytes ⁽⁶⁾ in messages that passed the check for this type of input (CRC, parity check, ...). The ratio of <code>NrBytesAccepted</code> to <code>NrBytesReceived</code> gives an indication of the quality of the communication link.
NrMsgReceived	u4	1 message		Total number of messages of type <code>Type</code> received.
NrMsgAccepted	u4	1 message		Total number of messages of type <code>Type</code> that were interpreted and used by the receiver. The ratio of <code>NrMsgAccepted</code> to <code>NrMsgReceived</code> gives an indication of the bandwidth usage efficiency
Padding	u1[.]			Padding bytes, see 4.1.5

⁽⁶⁾ Note that, for RTCM 2.x, one 8-bit byte contains 6 RTCM data bits.

OutputLink	Number:	4091
	"OnChange" interval:	1s

The `OutputLink` block reports statistics of the number of bytes sent on each active connection descriptor.

Per connection descriptor, the receiver maintains two byte counters `NrBytesProduced` and `NrBytesSent`, which are reported in the sub-block. They provide an indication of the amount of data output and data lost on a given connection.

These counters are reset simultaneously on the following events:

- start-up of the receiver
- overflow of one of the counters
- deactivation of a connection descriptor, e.g. on disconnection of USB or IP ports
- change of COM port settings.

There is one `OutputStatsSub` sub-block per connection descriptor for which statistics is available. Each `OutputStatsSub` sub-block contains a number of `OutputTypeSub` sub-blocks. These sub-blocks indicate which data type has been output through the connection in question during the last second. If no output happened during the last second, there is no `OutputTypeSub` sub-block.

Parameter	Type	Units	Do-Not-Use	Description
Sync1	c1			Block Header, see 4.1.1
Sync2	c1			
CRC	u2			
ID	u2			
Length	u2	1 byte		
TOW	u4	0.001 s	4294967295	Receiver time stamp, see 4.1.3
WNc	u2	1 week	65535	
N1	u1			Number of <code>OutputStatsSub</code> sub-blocks in this <code>OutputLink</code> block.
SB1Length	u1	1 byte		Length of an <code>OutputStatsSub</code> sub-block, excluding the nested <code>OutputTypeSub</code> sub-block
SB2Length	u1	1 byte		Length of an <code>OutputTypeSub</code> sub-block
Reserved	u1[3]			Reserved for future use
<i>OutputStats</i>		<i>A succession of N1 OutputStatsSub sub-blocks, see definition below</i>
Padding	u1[.]			Padding bytes, see 4.1.5

OutputStatsSub sub-block definition:

Parameter	Type	Units	Description																																														
CD	u1		Identifier of the connection to which this information applies:																																														
			<table border="1"> <thead> <tr> <th>Value of CD</th> <th>Connection type</th> <th>Example</th> </tr> </thead> <tbody> <tr> <td>0-31</td> <td>COMx, with x=CD</td> <td>1: COM1</td> </tr> <tr> <td>32-47</td> <td>USBx, with x=CD-32</td> <td>33: USB1</td> </tr> <tr> <td>48-63</td> <td>OTGx, with x=CD-48</td> <td>49: OTG1</td> </tr> <tr> <td>64-95</td> <td>IPx, with x=CD-54</td> <td>64:IP10</td> </tr> <tr> <td>96-127</td> <td>DSKx, with x=CD-96</td> <td>97:DSK1</td> </tr> <tr> <td>128-159</td> <td>NTRx, with x=CD-128 (NTRIP connections)</td> <td>129:NTR1</td> </tr> <tr> <td>160-191</td> <td>IPsx, with x=CD-160 (IP server connections)</td> <td>161:IPs1</td> </tr> <tr> <td>192</td> <td>BT01 (Bluetooth connection)</td> <td></td> </tr> <tr> <td>193</td> <td>BT02 (Bluetooth connection)</td> <td></td> </tr> <tr> <td>196</td> <td>UHF1 (UHF Modem)</td> <td></td> </tr> <tr> <td>200-205</td> <td>IPRx, with x=CD-200 (IP receive connections)</td> <td>201:IPR1</td> </tr> <tr> <td>210</td> <td>DCL1 (cellular data-call connection)</td> <td></td> </tr> <tr> <td>214</td> <td>CAN1 (CAN stream interface)</td> <td></td> </tr> <tr> <td>215-255</td> <td>Reserved</td> <td></td> </tr> </tbody> </table>		Value of CD	Connection type	Example	0-31	COMx, with x=CD	1: COM1	32-47	USBx, with x=CD-32	33: USB1	48-63	OTGx, with x=CD-48	49: OTG1	64-95	IPx, with x=CD-54	64:IP10	96-127	DSKx, with x=CD-96	97:DSK1	128-159	NTRx, with x=CD-128 (NTRIP connections)	129:NTR1	160-191	IPsx, with x=CD-160 (IP server connections)	161:IPs1	192	BT01 (Bluetooth connection)		193	BT02 (Bluetooth connection)		196	UHF1 (UHF Modem)		200-205	IPRx, with x=CD-200 (IP receive connections)	201:IPR1	210	DCL1 (cellular data-call connection)		214	CAN1 (CAN stream interface)		215-255	Reserved	
			Value of CD	Connection type	Example																																												
			0-31	COMx, with x=CD	1: COM1																																												
			32-47	USBx, with x=CD-32	33: USB1																																												
			48-63	OTGx, with x=CD-48	49: OTG1																																												
			64-95	IPx, with x=CD-54	64:IP10																																												
			96-127	DSKx, with x=CD-96	97:DSK1																																												
			128-159	NTRx, with x=CD-128 (NTRIP connections)	129:NTR1																																												
			160-191	IPsx, with x=CD-160 (IP server connections)	161:IPs1																																												
			192	BT01 (Bluetooth connection)																																													
			193	BT02 (Bluetooth connection)																																													
			196	UHF1 (UHF Modem)																																													
			200-205	IPRx, with x=CD-200 (IP receive connections)	201:IPR1																																												
210	DCL1 (cellular data-call connection)																																																
214	CAN1 (CAN stream interface)																																																
215-255	Reserved																																																
N2	u1		Number of OutputTypeSub sub-blocks included at the end of this OutputStatsSub sub-block																																														
AllowedRate	u2	1 kbyte / s	Maximum datarate recommended on this connection																																														
NrBytesProduced	u4	1 byte	Total number of bytes produced by the receiver. See also the NrBytesSent field.																																														
NrBytesSent	u4	1 byte	Total number of bytes actually sent (i.e. without congestions or transmission errors). The ratio of NrBytesSent to NrBytesProduced gives an indication of the amount of bandwidth overload. NrBytesSent and NrBytesProduced are 32-bit counters. If one of them overflows, both counters are reset to zero.																																														
NrClients	u1		Number of clients currently connected to this connection. Most connection types can only serve one client at a time, but each IP server (IPS) port can serve up to eight simultaneous clients. Note that when NrClients is more than one, the fields NrBytesProduced and NrBytesSent are the number of bytes produced and sent to each individual client.																																														
Reserved	u1[3]		Reserved for future use																																														
Padding	u1[...]		Padding bytes, see 4.1.5																																														
OutputType	A succession of N2 OutputTypeSub sub-blocks, see definition below																																														

Rev 1

OutputTypeSub sub-block definition:

Parameter	Type	Units	Description
Type	u1		Type of data: 0: none 1: DaisyChain (includes "echo" messages) 32: CMD 33: SBF 34: AsciiDisplay (see setDataInOut command) 35: RINEX 36: CGGTTS 40: BINEX 64: NMEA 96: RTCMv2 97: RTCMv3 98: CMRv2 99: RTCMV (a proprietary variant of RTCMv2) 118: raw LBAND data from Beam1 119: raw LBAND data from Beam2 120: raw LBAND data from Beam3 121: raw LBAND data from Beam4
Percentage	u1	1 %	Percentage of the produced bytes that belong to this type (during the last second)
Padding	u1[.]		Padding bytes, see 4.1.5

<code>NTRIPClientStatus</code>	Number: 4053 "OnChange" interval: 1s
--------------------------------	---

This block reports the current status of the NTRIP client connections.

Parameter	Type	Units	Do-Not-Use	Description
<code>Sync1</code>	c1			Block Header, see 4.1.1
<code>Sync2</code>	c1			
<code>CRC</code>	u2			
<code>ID</code>	u2			
<code>Length</code>	u2	1 byte		
<code>TOW</code>	u4	0.001 s	4294967295	Receiver time stamp, see 4.1.3
<code>WNc</code>	u2	1 week	65535	
<code>N</code>	u1			Number of NTRIP client connections for which status is provided in this block, i.e. number of <code>NTRIPClientConnection</code> sub-blocks.
<code>SBLength</code>	u1	1 byte		Length of one <code>NTRIPClientConnection</code> sub-block
<code>NTRIPClientConnection</code>		<i>A succession of N NTRIPClientConnection sub-blocks, see definition below</i>
<code>Padding</code>	u1[.]			Padding bytes, see 4.1.5

NTRIPClientConnection sub-block definition:

Parameter	Type	Units	Description
CDIndex	u1		Index of the NTRIP connection (1 for NTR1, 2 for NTR2, etc) for which status is provided in this sub-block.
Status	u1		NTRIP client status: 0: Connection disabled 1: Initializing 2: Running, differential corrections are being received and the link statistics is available in the <code>InputLink</code> block. 3: Error detected, the error code is provided in the next field. 4: Retrying, client encountered an error, we are trying to reconnect. The error code is provided in the next field. 5: Disabled since the settings are a duplicate of another active NTRIP connection.
ErrorCode	u1		NTRIP error code: 0: No error 1: Initialization error (e.g. source table retrieval failure) 2: Authentication error 3: Connection error 4: Mountpoint does not exist 5: Mountpoint unavailable 6: Waiting for GGA 7: GGA sending disabled when required by mountpoint 8: Resolving host failed 9: Out of region 10: TLS setup error 11: TLS handshake error 12: TLS fingerprint error 13: TLS time not known 254: Unknown error
Info	u1		Bitfield indicating miscellaneous info about the Connection status: Bit 0: TLS was used to make secure NTRIP connection if this bit is set Bits 1-7: Reserved
Padding	u1[.]		Padding bytes, see 4.1.5

NTRIPServerStatus	Number: 4122 "OnChange" interval: 1s
-------------------	---

This block reports the current status of the NTRIP server connections.

Parameter	Type	Units	Do-Not-Use	Description
Sync1	c1			Block Header, see 4.1.1
Sync2	c1			
CRC	u2			
ID	u2			
Length	u2	1 byte		
TOW	u4	0.001 s	4294967295	Receiver time stamp, see 4.1.3
WNc	u2	1 week	65535	
N	u1			Number of NTRIP server connections for which status is provided in this block, i.e. number of <code>NTRIPServerConnection</code> sub-blocks.
SBLength	u1	1 byte		Length of one <code>NTRIPServerConnection</code> sub-block
<i>NTRIPServerConnection</i>		<i>A succession of N NTRIPServerConnection sub-blocks, see definition below</i>
Padding	u1[.]			Padding bytes, see 4.1.5

NTRIPServerConnection sub-block definition:

Parameter	Type	Units	Description
CDIndex	u1		Index of the NTRIP connection (1 for NTR1, 2 for NTR2, etc) for which status is provided in this sub-block.
Status	u1		NTRIP server status: 0: Connection disabled 1: Initializing 2: Running, differential corrections are being sent and the link statistics is available in the <code>OutputLink</code> block. 3: Error detected, the error code is provided in the next field. 4: Error detected. Currently trying to reconnect. The error code is provided in the next field. 5: Disabled since the settings are a duplicate of another active NTRIP connection.
ErrorCode	u1		NTRIP error code: 0: No error 1: Initialization error 2: Authentication error 3: Connection error 4: Mountpoint does not exist 5: Configuration conflict error 6: Resolving host failed 7: TLS setup error 8: TLS handshake error 9: TLS fingerprint error 10: TLS time not known 254: Unknown error
Info	u1		Bitfield indicating miscellaneous info about the Connection status: Bit 0: TLS was used to make secure NTRIP connection if this bit is set Bits 1-7: Reserved
Padding	u1[.]		Padding bytes, see 4.1.5

IPStatus	Number: 4058 "OnChange" interval: output each time one or more IP parameters change
----------	--

This block contains information on the receiver's Ethernet interface (hostname, IP address, gateway, netmask and MAC address).

Parameter	Type	Units	Do-Not-Use	Description
Sync1	c1			Block Header, see 4.1.1
Sync2	c1			
CRC	u2			
ID	u2			
Length	u2	1 byte		
TOW	u4	0.001 s	4294967295	Receiver time stamp, see 4.1.3
WNc	u2	1 week	65535	
MACAddress	u1[6]			MAC address. The first byte corresponds to the MSB of the address.
IPAddress	u1[16]		All elements set to 0	IP address. For future upgradability, this field can contain a 128-bit IPv6 address. In the current firmware version, the first 12 bytes are always set to 0, and the last 4 bytes contain the IPv4 IP address, or are set to zero if the IP address is not known or not applicable.
Gateway	u1[16]		All elements set to 0	Gateway address. For future upgradability, this field can contain a 128-bit IPv6 address. In the current firmware version, the first 12 bytes are always set to 0, and the last 4 bytes contain the IPv4 IP address, or are set to zero if the gateway address is not known or not applicable.
Netmask	u1		255	Number of bits used to identify the network (CIDR notation).
Reserved	u1[3]			Reserved for future use, to be ignored by decoding software.
HostName	c1[32]			Receiver hostname on the Ethernet interface, or empty if not known.
Padding	u1[.]			Padding bytes, see 4.1.5

Rev 1

DynDNSStatus	Number: 4105 "OnChange" interval: 1s
--------------	---

This block contains dynamic DNS (DynDNS) status information.

Parameter	Type	Units	Do-Not-Use	Description
Sync1	c1			Block Header, see 4.1.1
Sync2	c1			
CRC	u2			
ID	u2			
Length	u2	1 byte		
TOW	u4	0.001 s	4294967295	Receiver time stamp, see 4.1.3
WNc	u2	1 week	65535	
Status	u1			DynDNS status: 0: DynDNS disabled 1: Updating IP address 2: IP address updated at the DynDNS server. DynDNS is ready to use. 254: Error detected, the error code is provided in the next field.
ErrorCode	u1			DynDNS error code: 0: No error 1: Unspecified error 2: Abusive update 3: User name and password mismatch 4: Not a credited user 5: Hostname is not a fully-qualified domain name 6: Hostname does not exist in this user account 7: Hostname blocked for update abuse 8: Bad agent 9: DNS error 10: DynDNS server problem or maintenance 11: DynDNS server not reachable
IPAddress	u1[16]		All elements set to 0	IP address that has been registered at the DynDNS server. For future upgradability, this field can contain a 128-bit IPv6 address. In the current firmware version, the first 12 bytes are always set to 0, and the last 4 bytes contain the IPv4 IP address, or are set to zero if the IP address is not known or not applicable (e.g. because registration failed).
Padding	u1[..]			Padding bytes, see 4.1.5

Rev 1

QualityInd	Number:	4082
	"OnChange" interval:	1s

The `QualityInd` block contains quality indicators for the main functions of the receiver. Each quality indicator is a value from 0 to 10, 0 corresponding to poor quality and 10 to very high quality.

Parameter	Type	Units	Do-Not-Use	Description
Sync1	c1			Block Header, see 4.1.1
Sync2	c1			
CRC	u2			
ID	u2			
Length	u2	1 byte		
TOW	u4	0.001 s	4294967295	Receiver time stamp, see 4.1.3
WNc	u2	1 week	65535	
N	u1			Number of quality indicators contained in this block
Reserved	u1			Reserved for future use, to be ignored by decoding software.
Indicators	u2[N]			N successive quality indicators, coded as follows: Bits 0-7: Quality indicator type: 0: Overall quality 1: GNSS signals from main antenna 2: GNSS signals from aux1 antenna 11: RF power level from the main antenna 12: RF power level from the aux1 antenna 21: CPU headroom 25: OCXO stability (only available on PolaRx5S receivers) 30: Base station measurements. This indicator is only available in RTK mode. A low value could for example hint at severe multipath or interference at the base station, or also at ionospheric scintillation. 31: RTK post-processing. This indicator is only available when the position mode is not RTK. It indicates the likelihood of getting a cm-accurate RTK position when post-processing the current data. All elements set to 15 Bits 8-11: Value of this quality indicator (from 0 for low quality to 10 for high quality, or 15 if unknown) Bits 12-15: Reserved for future use, to be ignored by decoding software.
Padding	u1[.]			Padding bytes, see 4.1.5

DiskStatus	Number: 4059 "OnChange" interval: 1s
------------	---

This block reports the size and usage of the disks mounted on the receiver.

Parameter	Type	Units	Do-Not-Use	Description
Sync1	c1			Block Header, see 4.1.1
Sync2	c1			
CRC	u2			
ID	u2			
Length	u2	1 byte		
TOW	u4	0.001 s	4294967295	Receiver time stamp, see 4.1.3
WNc	u2	1 week	65535	
N	u1			Number of <code>DiskData</code> sub-blocks this block contains.
SBLength	u1	1 byte		Length of one <code>DiskData</code> sub-blocks in bytes.
Reserved	u1[4]			Reserved for future use
<i>DiskData</i>		<i>A succession of N DiskData sub-blocks, see definition below</i>
Padding	u1[.]			Padding bytes, see 4.1.5

DiskData sub-block definition:

Rev 1

Parameter	Type	Units	Do-Not-Use	Description
DiskID	u1			ID of the disk, starting at 1 for the internal SD Memory Card.
Status	u1			Bit field: Bit 0: DISK_MOUNTED: bit set when the disk is mounted. Bit 1: DISK_FULL: bit set when the disk is full. A disk is full when it is filled to 95% of its total capacity. Bit 2: DISK_ACTIVITY: bit set for one second each time data is written to the disk. If the logging rate is larger than 1 Hz, set continuously. Bit 3: LOGGING_ENABLED: bit set when at least one file is open on the disk, regardless of the logging rate. Bit 4: MOUNTING: bit set when disk is being mounted. Bit 5: FORMATTING: bit set when disk is being formatted. Bits 6-7: Reserved
DiskUsageMSB	u2		65535 ⁽⁷⁾	16 MSB of the total disk usage. The disk usage in bytes is given by $DiskUsageMSB * 4294967296 + DiskUsageLSB$.
DiskUsageLSB	u4		4294967295 ⁽⁷⁾	32 LSB of the total disk usage. The disk usage in bytes is given by $DiskUsageMSB * 4294967296 + DiskUsageLSB$.
DiskSize	u4	1 Mbyte	0	Total size of the disk, in megabytes.
CreateDeleteCount	u1			Counter incremented by one each time a file or a folder is created or deleted on this disk. This counter starts at zero at receiver start-up and restarts at zero after having reached 255.
Error	u1		255	Disk error: 0: No error 1: Disk partition is too large 2: Disk does not have any partition 3: File system check and recovery failed 4: Disk in use over USB 254: Disk mount failed due to unknown error
Padding	u1[.]			Padding bytes, see 4.1.5

Rev 1

⁽⁷⁾ The disk usage is invalid if both DiskUsageMSB is 65535 and DiskUsageLSB is 4294967295.

RFStatus	Number: 4092 "OnChange" interval: 1s
----------	---

The `RFStatus` block provides information on the radio-frequency (RF) bands where interferences have been detected and/or notch filters have been applied.

Parameter	Type	Units	Do-Not-Use	Description
Sync1	c1			Block Header, see 4.1.1
Sync2	c1			
CRC	u2			
ID	u2			
Length	u2	1 byte		
TOW	u4	0.001 s	4294967295	Receiver time stamp, see 4.1.3
WNc	u2	1 week	65535	
N	u1			Number of RF bands for which data is provided in this SBF block, i.e. number of <code>RFBand</code> sub-blocks.
SBLength	u1	1 byte		Length of one sub-block
Flags	u1			Bit field: Bit 0: Set when a spoofing suspicion is determined. Bits 1-7: Reserved
Reserved	u1[3]			Reserved for future use, to be ignored by decoding software.
<i>RFBand</i>		<i>A succession of N RFBand sub-blocks, see definition below</i>
Padding	u1[.]			Padding bytes, see 4.1.5

`RFBand` sub-block definition:

Parameter	Type	Units	Description
Frequency	u4	1 Hz	Center frequency of the RF band addressed by this sub-block.
Bandwidth	u2	1 kHz	Bandwidth of the RF band.
Info	u1		Info on this RF band: Bits 0-3: Mode: 1: This RF band is suppressed by a notch filter set manually with the command setNotchFiltering . 2: The receiver detected interference in this band, and successfully canceled it. 8: The receiver detected interference in this band. No mitigation applied. Bits 4-5: Reserved Bits 6-7: Antenna ID: 0 for main, 1 for <i>Aux1</i> and 2 for <i>Aux2</i>
Padding	u1[.]		Padding bytes, see 4.1.5

P2PPStatus	Number: 4238 "OnChange" interval: 1s
------------	---

This block reports the status of the active P2PP (Point-to-Point Protocol) sessions. See the **setPointToPoint** command for details.

Parameter	Type	Units	Do-Not-Use	Description
Sync1	c1			Block Header, see 4.1.1
Sync2	c1			
CRC	u2			
ID	u2			
Length	u2	1 byte		
TOW	u4	0.001 s	4294967295	Receiver time stamp, see 4.1.3
WNC	u2	1 week	65535	
N	u1			Number of active P2PP sessions for which status is provided in this block, i.e. number of P2PPSession sub-blocks.
SBLength	u1	1 byte		Length of one P2PPSession sub-block
P2PPSession		A succession of N P2PPSession sub-blocks, see definition below
Padding	u1[.]			Padding bytes, see 4.1.5

P2PPSession sub-block definition:

Parameter	Type	Units	Description
SessionID	u1		Index of the P2PP session (1 for P2PP1, 2 for P2PP2, etc) for which status is provided in this sub-block.
Port	u1		Index for the COM port the P2PP session is configured on (1 for COM1, 2 for COM2, etc).
Status	u1		Bit field: Bit 0: Mode: Bit set if the P2PP session is in Server mode, and unset if it is in Client mode (future functionality). Bits 1-7: P2PP status: 0: Initializing 1: Waiting for Connection 2: Connected 3: Disconnecting 4: Error, see ErrorCode field below
ErrorCode	u1		P2PP error: 1: No error 2: Configuration 3: Port Acquisition 4: Port Lock 5: Start Daemon 6: Server Authentication 7: Client Authentication 8: Timeout on Activity 9: Timeout on Negotiation 10: Link Negotiation 255: Unspecified
Padding	u1[.]		Padding bytes, see 4.1.5

CosmosStatus	Number: 4243 "OnChange" interval: 1s
--------------	---

The `CosmosStatus` block provides information on the status of the Cosmos receiver service.

Parameter	Type	Units	Do-Not-Use	Description
Sync1	c1			Block Header, see 4.1.1
Sync2	c1			
CRC	u2			
ID	u2			
Length	u2	1 byte		
TOW	u4	0.001 s	4294967295	Receiver time stamp, see 4.1.3
WNc	u2	1 week	65535	
Status	u1			The status of Cosmos receiver service: 0: Disabled 1: Running
Padding	u1[.]			Padding bytes, see 4.1.5

4.2.16 Miscellaneous Blocks

ReceiverSetup	Number: 5902 "OnChange" interval: Block generated each time a user-command is entered to change one or more values in the block (e.g. when entering the setMarkerParameters command)
---------------	--

The `ReceiverSetup` block contains parameters related to the receiver and its installation. When generating RINEX files, this block defines the RINEX file name and the contents of the header.

For all fields containing a string, if the length of the string is lower than the size of the corresponding field, the unused bytes are set to zero.

Parameter	Type	Units	Do-Not-Use	Description	
Sync1	c1			Block Header, see 4.1.1	
Sync2	c1				
CRC	u2				
ID	u2				
Length	u2	1 byte			
TOW	u4	0.001 s	4294967295	Receiver time stamp, see 4.1.3	
WNc	u2	1 week	65535		
Reserved	u1[2]			2 bytes reserved for future use, to be ignored by decoding software	
MarkerName	c1[60]			Marker name (set with setMarkerParameters).	
MarkerNumber	c1[20]			Marker number (set with setMarkerParameters).	
Observer	c1[20]			Observer name (set with setObserverParameters).	
Agency	c1[40]			Observer agency (set with setObserverParameters).	
RxSerialNumber	c1[20]			Receiver serial number.	
RxName	c1[20]			Receiver GNSS engine name.	
RxVersion	c1[20]			Receiver firmware version.	
AntSerialNbr	c1[20]			Serial number of the main antenna (set with setAntennaOffset).	
AntType	c1[20]			Type of the main antenna (set with setAntennaOffset).	
deltaH	f4	1 m		δH offset of the main antenna (set with setAntennaOffset).	
deltaE	f4	1 m		δE offset of the main antenna (set with setAntennaOffset).	
deltaN	f4	1 m		δN offset of the main antenna (set with setAntennaOffset).	
Rev 1 MarkerType	c1[20]			Marker type (set with the setMarkerParameters command).	
Rev 2 GNSSFVersion	c1[40]			Version the firmware installed on the receiver.	
Rev 3 ProductName	c1[40]			Product name.	
Rev 4	Latitude	f8	1 rad	$-2 \cdot 10^{10}$	Latitude of the reference position, from $-\pi/2$ to $+\pi/2$, positive North of Equator. Use the setPVTMode command to set the reference position.
	Longitude	f8	1 rad	$-2 \cdot 10^{10}$	Longitude of the reference position, from $-\pi$ to $+\pi$, positive East of Greenwich. Use the setPVTMode command to set the reference position.
	Height	f4	1 m	$-2 \cdot 10^{10}$	Ellipsoidal height of the reference position (with respect to WGS84 ellipsoid). Use the setPVTMode command to set the reference position.
Rev 4	StationCode	c1[10]			Station code (set with setMarkerParameters). This field can for example contains the four-letter IGS station code assigned to the receiver.
	MonumentIdx	u1			Monument index (set with setMarkerParameters). This index is used to identify the monument when there are multiple monuments at the same station.
	ReceiverIdx	u1			Receiver index (set with setMarkerParameters). This index is used to identify the receiver when there are multiple receivers at the same monument.
	CountryCode	c1[3]			ISO 3-character country code (set with the setMarkerParameters command).
	Reserved1	c1[21]			Reserved.
	Padding	u1[.]			Padding bytes, see 4.1.5

RxMessage	Number: 4103
	"OnChange" interval: block generated each time a message needs to be sent

The receiver generates ASCII messages to help users follow the progress of processes such as file logging or FTP push (activity log). These messages are output in the `RxMessage` block, and they can also be retrieved from the command line using the `lif, RxMessages` command.

Parameter	Type	Units	Do-Not-Use	Description
Sync1	c1			Block Header, see 4.1.1
Sync2	c1			
CRC	u2			
ID	u2			
Length	u2	1 byte		
TOW	u4	0.001 s	4294967295	Receiver time stamp, see 4.1.3
WNc	u2	1 week	65535	
Type	u1		255	Type of message contained in this block: 1: Asynchronous command reply 2: Message about internal logging 3: Message about FTP push 4: Message about Receiver Status 5: Message from slave GNSS receiver 6: Message about CloudIt
Severity	u1		255	Message severity: 1: Info 2: Warning 3: Error
MessageID	u4		0	A unique value associated to each message. This is a counter starting at 1 for the first message after boot and incrementing at each message.
StringLn	u2			Length of <code>Message</code> in characters, including the terminating <code>\0</code> .
Reserved2	u1[2]			Reserved, contents to be ignored.
Message	c1[StringLn]			Receiver message terminated by <code>\0</code> .
Padding	u1[.]			Padding bytes, see 4.1.5

Commands	Number: 4015 "OnChange" interval: each time a user command is entered
----------	--

Every time the user sends a command, a `Commands` block is output on all ports for which this block is enabled. The `Commands` SBF block is inserted in the SBF stream at the very moment when the command starts to take effect.

Parameter	Type	Units	Do-Not-Use	Description
Sync1	c1			Block Header, see 4.1.1
Sync2	c1			
CRC	u2			
ID	u2			
Length	u2	1 byte		
TOW	u4	0.001 s	4294967295	Receiver time stamp, see 4.1.3
WNc	u2	1 week	65535	
Reserved	u1[2]			Reserved for future use, to be ignored by decoding software.
CmdData	u1[M]			Command data, this is the command in the SNMP' format (reserved for maintenance and support only).
Padding	u1[.]			Padding bytes, see 4.1.5

Comment	Number: 5936 "OnChange" interval: block generated each time a comment is entered with setObserverComment
---------	--

The `Comment` block contains a comment string as entered with the **setObserverComment** command.

Parameter	Type	Units	Do-Not-Use	Description
Sync1	c1			Block Header, see 4.1.1
Sync2	c1			
CRC	u2			
ID	u2			
Length	u2	1 byte		
TOW	u4	0.001 s	4294967295	Receiver time stamp, see 4.1.3
WNc	u2	1 week	65535	
CommentLn	u2			Length of the <code>Comment</code> string, in characters. The maximum length of a comment is 120 characters.
Comment	c1[CommentLn]			Comment string, as entered with the setObserverComment command. Note that this string is not terminated by the "\0" character.
Padding	u1[..]			Padding bytes, see 4.1.5

BBSamples	Number:	4040
	"OnChange" interval:	block generated each time new baseband samples are ready (typically at 2Hz)

The `BBSamples` block contains a series of successive complex baseband samples. These samples can be used for signal monitoring and for spectral analysis of the GNSS bands supported by the receiver.

Parameter	Type	Units	Do-Not-Use	Description
Sync1	c1			Block Header, see 4.1.1
Sync2	c1			
CRC	u2			
ID	u2			
Length	u2	1 byte		
TOW	u4	0.001 s	4294967295	External time stamp, see 4.1.3
WNc	u2	1 week	65535	
N	u2			Number of complex baseband samples contained in this block
Info	u1			Bit field as follows: Bits 0-2: Antenna ID: antenna from which the samples have been taken: 0 for main, 1 for <i>Aux1</i> and 2 for <i>Aux2</i> . Bits 3-7: Reserved
Reserved	u1[3]			Reserved for future use, to be ignored by decoding software.
SampleFreq	u4	1 Hz		Sampling frequency in Hz.
LOFreq	u4	1 Hz		Frequency of the local oscillator (LO) used to down-convert the RF signal to baseband.
Samples	u2[N]			N successive complex baseband samples (I+jQ), coded as follows: Bits 0-7: 8-bit Q component, two's complement. Bits 8-15: 8-bit I component, two's complement.
Padding	u1[.]			Padding bytes, see 4.1.5

ASCIINumber:	4075
"OnChange" interval:	block generated each time an ASCII string is received

The `ASCIIN` block contains a string that has been received on one of the receiver's connection ports.

More specifically, this block is output each time an end-of-line character is received on a communication port configured to receive `ASCIIN` input (with the `setDataInOut` command). The string reported in this block contains all characters received since the previous occurrence of an end-of-line character.

The maximum length of the string is 2000 characters. If there are more than 2000 characters between the occurrence of two successive end-of-line characters, the string is discarded

Parameter	Type	Units	Do-Not-Use	Description																																							
Sync1	c1			Block Header, see 4.1.1																																							
Sync2	c1																																										
CRC	u2																																										
ID	u2																																										
Length	u2	1 byte																																									
TOW	u4	0.001 s	4294967295	Receiver time stamp, see 4.1.3																																							
WNc	u2	1 week	65535																																								
CD	u1			Identifier of the connection from which the data has been received: <table border="1" data-bbox="751 1099 1385 1671"> <thead> <tr> <th>Value of CD</th> <th>Connection type</th> <th>Example</th> </tr> </thead> <tbody> <tr> <td>0-31</td> <td>COMx, with x=CD</td> <td>1: COM1</td> </tr> <tr> <td>32-47</td> <td>USBx, with x=CD-32</td> <td>33: USB1</td> </tr> <tr> <td>48-63</td> <td>OTGx, with x=CD-48</td> <td>49: OTG1</td> </tr> <tr> <td>64-95</td> <td>IPx, with x=CD-54</td> <td>64:IP10</td> </tr> <tr> <td>128-159</td> <td>NTRx, with x=CD-128 (NTRIP connections)</td> <td>129:NTR1</td> </tr> <tr> <td>192</td> <td>BT01 (Bluetooth connection)</td> <td></td> </tr> <tr> <td>193</td> <td>BT02 (Bluetooth connection)</td> <td></td> </tr> <tr> <td>196</td> <td>UHF1 (UHF Modem)</td> <td></td> </tr> <tr> <td>200-205</td> <td>IPRx, with x=CD-200 (IP receive connections)</td> <td>201:IPR1</td> </tr> <tr> <td>210</td> <td>DCL1 (cellular data-call connection)</td> <td></td> </tr> <tr> <td>214</td> <td>CAN1 (CAN stream interface)</td> <td></td> </tr> <tr> <td>215-255</td> <td>Reserved</td> <td></td> </tr> </tbody> </table>	Value of CD	Connection type	Example	0-31	COMx, with x=CD	1: COM1	32-47	USBx, with x=CD-32	33: USB1	48-63	OTGx, with x=CD-48	49: OTG1	64-95	IPx, with x=CD-54	64:IP10	128-159	NTRx, with x=CD-128 (NTRIP connections)	129:NTR1	192	BT01 (Bluetooth connection)		193	BT02 (Bluetooth connection)		196	UHF1 (UHF Modem)		200-205	IPRx, with x=CD-200 (IP receive connections)	201:IPR1	210	DCL1 (cellular data-call connection)		214	CAN1 (CAN stream interface)		215-255	Reserved	
Value of CD	Connection type	Example																																									
0-31	COMx, with x=CD	1: COM1																																									
32-47	USBx, with x=CD-32	33: USB1																																									
48-63	OTGx, with x=CD-48	49: OTG1																																									
64-95	IPx, with x=CD-54	64:IP10																																									
128-159	NTRx, with x=CD-128 (NTRIP connections)	129:NTR1																																									
192	BT01 (Bluetooth connection)																																										
193	BT02 (Bluetooth connection)																																										
196	UHF1 (UHF Modem)																																										
200-205	IPRx, with x=CD-200 (IP receive connections)	201:IPR1																																									
210	DCL1 (cellular data-call connection)																																										
214	CAN1 (CAN stream interface)																																										
215-255	Reserved																																										
Reserved1	u1[3]			Reserved, contents to be ignored.																																							
StringLength	u2			Length of <code>ASCIIString</code> in characters.																																							
SensorModel	c1[20]			Not supported, reserved for future use.																																							
SensorType	c1[20]			Not supported, reserved for future use.																																							
Reserved2	u1[20]			Reserved, contents to be ignored.																																							
ASCIIString	c1[StringLn]			ASCII string. Note that this string is not terminated by the "\0" character. The string does not include the end-of-line character(s) (carrier return and/or line feed).																																							
Padding	u1[..]			Padding bytes, see 4.1.5																																							

EncapsulatedOutput	Number: 4097 "OnChange" interval: output each time an RTCM, CMR, NMEA or ASCIIIDisplay message is output
--------------------	---

The `EncapsulatedOutput` block encapsulates non-SBF output messages into SBF. It is enabled with the `Encapsulate` option of the `setDataInOut` command.

Parameter	Type	Units	Do-Not-Use	Description
Sync1	c1			Block Header, see 4.1.1
Sync2	c1			
CRC	u2			
ID	u2			
Length	u2	1 byte		
TOW	u4	0.001 s	4294967295	Receiver time stamp, see 4.1.3
WNc	u2	1 week	65535	
Mode	u1			Type of the message encapsulated in the <code>Payload</code> field: 0: RTCMv2 1: CMRv2 2: RTCMv3 4: NMEA 5: ASCIIIDisplay
Reserved	u1			Reserved for future use, to be ignored by decoding software.
N	u2			Length of <code>Payload</code> in bytes.
ReservedId	u2			Reserved for future use
Payload	u1[N]			Encapsulated message.
Padding	u1[.]			Padding bytes, see 4.1.5

4.2.17 PinPoint-GIS RX

GISAction	Number: 4106
	"OnChange" interval: each time an item is added or changed

This block logs all the changes to the collection databases. The block is output every time the user collects, updates or deletes an item with the PinPoint-GIS RX commands, and indicates the nature of the change.

Parameter	Type	Units	Do-Not-Use	Description
Sync1	c1			Block Header, see 4.1.1
Sync2	c1			
CRC	u2			
ID	u2			
Length	u2	1 byte		
TOW	u4	0.001 s	4294967295	Receiver time stamp, see 4.1.3
WNc	u2	1 week	65535	
CommentLn	u2			Length of the <code>Comment</code> string in characters.
ItemIDMSB	u4			32 MSBs of the 64-bit item ID
ItemIDLSB	u4			32 LSBs of the 64-bit item ID
Action	u1			Indicates the action for the collected item: 0: Add 1: Update 2: Delete
Trigger	u1			Indicates what triggered the change: 0: Change triggered by <code>exeCollectPoint</code> , <code>exeUpdatePoint</code> or <code>exeDeletePoint</code> command
Database	u1			Indicates to which collection database the item belongs: 1: CollectDB1 2: CollectDB2 3: CollectDB3
Reserved	u1			Reserved.
Comment	c1[CommentLn]			Comment string. Note that this string is not terminated by the "\0" character.
Padding	u1[.]			Padding bytes, see 4.1.5

GISStatus	Number: 4107 "OnChange" interval: 1s
-----------	---

This block contains status information about the different PinPoint-GIS collection databases.

Parameter	Type	Units	Do-Not-Use	Description
Sync1	c1			Block Header, see 4.1.1
Sync2	c1			
CRC	u2			
ID	u2			
Length	u2	1 byte		
TOW	u4	0.001 s	4294967295	Receiver time stamp, see 4.1.3
WNc	u2	1 week	65535	
N	u1			Number of collection databases for which status information is provided in this block.
SBLength	u1	1 byte		Length of one <i>DatabaseStatus</i> sub-block
<i>DatabaseStatus</i>		<i>A succession of N DatabaseStatus sub-blocks, see definition below</i>
Padding	u1[.]			Padding bytes, see 4.1.5

DatabaseStatus sub-block definition:

Parameter	Type	Units	Description
Database	u1		The database to which the status applies: 1: CollectDB1 2: CollectDB2 3: CollectDB3
OnlineStatus	u1		When the database is linked to an online service (e.g. ArcGIS online) this field represents the login status: 0: table not linked to an online service 1: not logged in 2: logged in 3: login error
Error	u1		Database error code: 0: No error 1: Disk is not mounted 2: Disk is full, export to CSV (exeWriteCollectCsvFile command) and point operations (exeCollectPoint or exeUpdatePoint commands) will fail 255: Unknown error
Reserved	u1		Reserved.
NrItems	u4		The number of items in the database.
NrNotSync	u4		When the database is linked to an online service (e.g. ArcGIS online) this field represents how many points are not synced yet to the online service. Use the exeSyncArcGis command to manually sync ArcGIS.
Padding	u1[.]		Padding bytes, see 4.1.5

4.3 SBF Change Log

Date	Change Description
Apr 10, 2020	Added the <code>NTRIPServerStatus</code> block for the NTRIP server connection status
May 16, 2019	Added the <code>P2PPStatus</code> block to report the status of the Point-to-Point sessions
Apr 26, 2019	Added the <code>QZSA1m</code> block containing QZSS almanac parameters
Apr 8, 2019	Renamed <code>IRNSSRaw</code> to <code>NAVICRaw</code>
Mar 12, 2019	Added the <code>BDSA1m</code> block containing BeiDou almanac parameters
Apr 19, 2018	Added the <code>BDSRawB1C</code> block containing the raw BeiDou B1C navigation symbols
Apr 19, 2018	Added the <code>BDSRawB2a</code> block containing the raw BeiDou B2a navigation symbols
Jun 20, 2017	Added the <code>BDSIon</code> and <code>BDSUtc</code> blocks containing BeiDou ionospheric and UTC offset parameters
Jun 15, 2017	Added the <code>Meas3PP</code> and <code>Meas3MP</code> blocks to supplement the <code>Meas3Ranges</code> block
Mar 6, 2017	Added the <code>Meas3Ranges</code> , <code>Meas3CN0HiRes</code> and <code>Meas3Doppler</code> blocks containing GNSS measurements
Mar 1, 2017	Renamed <code>CMPNav</code> to <code>BDSNav</code> and <code>CMPRaw</code> to <code>BDSRaw</code>
Nov 10, 2015	Added the <code>RxMessage</code> block containing the receiver activity log
Feb 04, 2015	Added the <code>QZSNav</code> block containing decoded QZSS navigation data
Jan 13, 2015	Added the <code>PosProjected</code> block containing plane grid coordinates
Dec 12, 2014	Added the base measurements quality indicator
Nov 6, 2014	Added the <code>RFStatus</code> block for interference mitigation monitoring
April 30, 2014	Added new values for the <code>Datum</code> field
April 22, 2014	Added the <code>DiskStatus</code> block reporting the disk usage and free space of the disks available on the receiver
Feb 21, 2014	Added the <code>NTRIPClientStatus</code> block for the NTRIP client connection status
March 14, 2013	Added the <code>QualityInd</code> block containing various quality indicators
Feb 19, 2013	Added the <code>CMPNav</code> block containing decoded BeiDou navigation data
Feb 8, 2013	Fixed typo: field <code>t_oG</code> of <code>GALGstGps</code> changed to type <code>u4</code> and units of seconds
Jan 8, 2013	Added fields <code>HAccuracy</code> , <code>VAccuracy</code> and <code>Misc</code> to the <code>PVTCartesian</code> and <code>PVTGeodetic</code> blocks
Dec 19, 2012	Added PRNs 139 and 140 to the list of SBAS satellites
Oct 25, 2012	Added <code>RTCMDatum</code> and <code>PosLocal</code> blocks
Oct 19, 2012	Added <code>GEORawL5</code> block
Oct 1, 2012	Added new signal type for L-band and SBAS L5 signals (value 23 and 25)

Sep 29, 2012	Added LBandBeams block and added SVID field to LBandTrackerStatus block
Sep 20, 2012	Added field PPPInfo to the PVTCartesian and PVTGeodetic blocks
Feb 28, 2012	Added GALSAARLM block
Feb 6, 2012	Added QZSS signals and QZSRawL1CA, QZSRawL2C and QZSRawL5 blocks

Appendix A

Attitude Angles

The attitude of the vehicle is defined as the angles between the vehicle reference frame and the local-level reference frame (defined by the East, North and Up directions). The vehicle reference frame is defined as follows. It is attached to the vehicle and has its X axis pointing along the longitudinal vehicle axis, the Y axis pointing towards the vehicle starboard (right) side and the Z axis pointing down, as illustrated in Figure A-1.

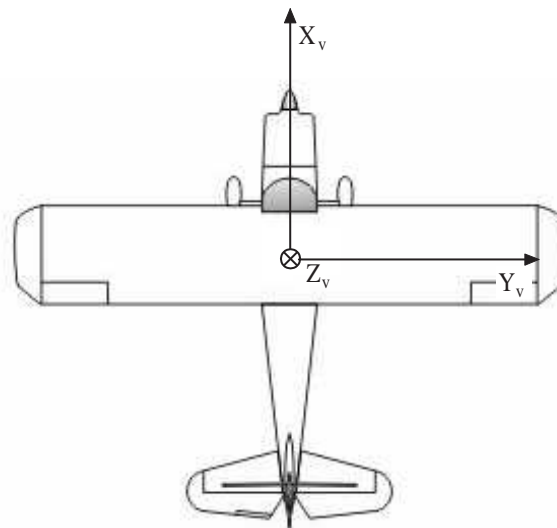

Figure A-1: Vehicle reference frame.

Septentrio receivers express the vehicle attitude in Euler angles using the heading-pitch-roll rotation sequence. More specifically, Euler angles are defined as successive rotations of the vehicle frame (X, Y, Z axes) relative to the local-level East-North-Up reference frame. The rotation sequence is shown in Figure A-2. The heading (ψ) of the vehicle is defined as the right-handed rotation of the vehicle about the Z axis ($0^\circ \leq \psi \leq 360^\circ$). The pitch (θ) of the vehicle is defined as the right-handed rotation about the vehicle Y axis ($-90^\circ \leq \theta \leq 90^\circ$). The roll (ϕ) of the vehicle is defined as the right-handed rotation about the vehicle X axis ($-180^\circ \leq \phi \leq 180^\circ$).

Starting from the situation where X points to the North, Y to the East and Z down, the following successive rotations define the attitude of the vehicle. Note that the order of the rotations is important.

1. Rotate through angle ψ about Z axis;
2. Rotate through angle θ about new Y axis;
3. Rotate through angle ϕ about new X axis;

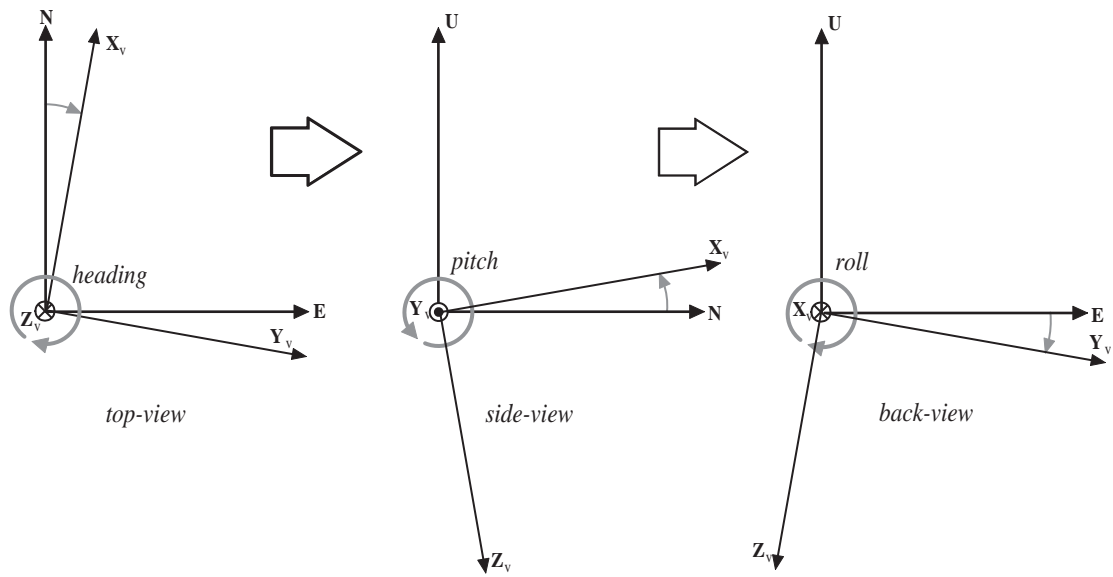

Figure A-2: Euler angle sequence.

Appendix B

List of SBF Blocks

The following table provides the list of the SBF block names and numbers available on mosaic-X5 and a short description of the associated contents. The block number is contained in bits 0 to 12 of the block ID field (see section 4.1.1).

The "Flex Rate" column indicates whether a given block can be output at a user-defined rate and the "esoc" column whether it can be used as an argument of the **exeSBFOnce** command (see also section 4.1.8). The "Time stamp" column indicates which type of time is encoded in the block time stamp (see section 4.1.3 for details).

Block name	Block No	Content description	Flex Rate	esoc	Time Stamp
Measurement Blocks					
MeasEpoch	4027	Measurement set of one epoch	•	•	R
MeasExtra	4000	Additional info such as observable variance	•	•	R
Meas3Ranges	4109	Code, phase and CN0 measurements	•	•	R
Meas3CN0HiRes	4110	Extension of Meas3Ranges containing fractional C/N0 values	•	•	R
Meas3Doppler	4111	Extension of Meas3Ranges containing Doppler values	•	•	R
Meas3PP	4112	Extension of Meas3Ranges containing proprietary flags for data post-processing.	•	•	R
Meas3MP	4113	Extension of Meas3Ranges containing multipath corrections applied by the receiver.	•	•	R
EndOfMeas	5922	Measurement epoch marker	•	•	R
Navigation Page Blocks					
GPSRawCA	4017	GPS CA navigation subframe			S
GPSRawL2C	4018	GPS L2C navigation frame			S
GPSRawL5	4019	GPS L5 navigation frame			S
GLORawCA	4026	GLONASS CA navigation string			S
GALRawFNAV	4022	Galileo F/NAV navigation page			S
GALRawINAV	4023	Galileo I/NAV navigation page			S
GEORawL1	4020	SBAS L1 navigation message			S
GEORawL5	4021	SBAS L5 navigation message			S
BDSRaw	4047	BeiDou navigation page			S
BDSRawB1C	4218	BeiDou B1C navigation frame			S
BDSRawB2a	4219	BeiDou B2a navigation frame			S
QZSRawL1CA	4066	QZSS L1 CA navigation frame			S
QZSRawL2C	4067	QZSS L2C navigation frame			S

Block name	Block No	Content description	Flex Rate	esoc	Time Stamp
QZSRawL5	4068	QZSS L5 navigation frame			S
NAVICRaw	4093	NavIC/IRNSS subframe			S
GPS Decoded Message Blocks					
GPSNav	5891	GPS ephemeris and clock		•	S
GPSAlm	5892	Almanac data for a GPS satellite		•	S
GPSIon	5893	Ionosphere data from the GPS subframe 5		•	S
GPSUtc	5894	GPS-UTC data from GPS subframe 5		•	S
GLONASS Decoded Message Blocks					
GLONav	4004	GLONASS ephemeris and clock		•	S
GLOAlm	4005	Almanac data for a GLONASS satellite		•	S
GLOTime	4036	GLO-UTC, GLO-GPS and GLO-UT1 data		•	S
Galileo Decoded Message Blocks					
GALNav	4002	Galileo ephemeris, clock, health and BGD		•	S
GALAlm	4003	Almanac data for a Galileo satellite		•	S
GALIon	4030	NeQuick Ionosphere model parameters		•	S
GALUtc	4031	GST-UTC data		•	S
GALGstGps	4032	GST-GPS data		•	S
GALSARLM	4034	Search-and-rescue return link message			S
BeiDou Decoded Message Blocks					
BDSNav	4081	BeiDou ephemeris and clock		•	S
BDSAlm	4119	Almanac data for a BeiDou satellite		•	S
BDSIon	4120	BeiDou Ionospheric delay model parameters		•	S
BDSUtc	4121	BDT-UTC data		•	S
QZSS Decoded Message Blocks					
QZSNav	4095	QZSS ephemeris and clock		•	S
QZSAlm	4116	Almanac data for a QZSS satellite		•	S
SBAS L1 Decoded Message Blocks					
GEOMT00	5925	MT00 : SBAS Don't use for safety applications			S
GEOPRNMask	5926	MT01 : PRN Mask assignments			S
GEOFastCorr	5927	MT02-05/24: Fast Corrections			S
GEOIntegrity	5928	MT06 : Integrity information			S
GEOFastCorrDegr	5929	MT07 : Fast correction degradation factors			S
GEONav	5896	MT09 : SBAS navigation message		•	S
GEODegrFactors	5930	MT10 : Degradation factors			S
GEONetworkTime	5918	MT12 : SBAS Network Time/UTC offset parameters			S
GEOAlm	5897	MT17 : SBAS satellite almanac		•	S
GEOIGPMask	5931	MT18 : Ionospheric grid point mask			S
GEOLongTermCorr	5932	MT24/25 : Long term satellite error corrections			S
GEOIonoDelay	5933	MT26 : Ionospheric delay corrections			S
GEOServiceLevel	5917	MT27 : SBAS Service Message			S
GEOClockEphCovMatrix	5934	MT28 : Clock-Ephemeris Covariance Matrix			S
Position, Velocity and Time Blocks					
PVTCartesian	4006	Position, velocity, and time in Cartesian coordinates	•	•	R
PVTGeodetic	4007	Position, velocity, and time in geodetic coordinates	•	•	R
PosCovCartesian	5905	Position covariance matrix (X,Y, Z)	•	•	R

Block name	Block No	Content description	Flex Rate	esoc	Time Stamp
PosCovGeodetic	5906	Position covariance matrix (Lat, Lon, Alt)	•	•	R
VelCovCartesian	5907	Velocity covariance matrix (X, Y, Z)	•	•	R
VelCovGeodetic	5908	Velocity covariance matrix (North, East, Up)	•	•	R
DOP	4001	Dilution of precision	•	•	R
PosCart	4044	Position, variance and baseline in Cartesian coordinates	•	•	R
PosLocal	4052	Position in a local datum	•	•	R
PosProjected	4094	Plane grid coordinates	•	•	R
BaseVectorCart	4043	XYZ relative position and velocity with respect to base(s)	•	•	R
BaseVectorGeod	4028	ENU relative position and velocity with respect to base(s)	•	•	R
PVTSupport	4076	Internal parameters for maintenance and support	•	•	R
PVTSupportA	4079	Internal parameters for maintenance and support	•	•	R
EndOfPVT	5921	PVT epoch marker	•	•	R
GNSS Attitude Blocks					
AttEuler	5938	GNSS attitude expressed as Euler angles	•	•	R
AttCovEuler	5939	Covariance matrix of attitude	•	•	R
EndOfAtt	5943	GNSS attitude epoch marker	•	•	R
Receiver Time Blocks					
ReceiverTime	5914	Current receiver and UTC time	•	•	R
xPPSOffset	5911	Offset of the xPPS pulse with respect to GNSS time			R
External Event Blocks					
ExtEvent	5924	Time at the instant of an external event			E
ExtEventPVTCartesian	4037	Cartesian position at the instant of an event			E
ExtEventPVTGeodetic	4038	Geodetic position at the instant of an event			E
ExtEventBaseVectGeod	4217	ENU relative position with respect to base(s) at the instant of an event			E
ExtEventAttEuler	4237	GNSS attitude expressed as Euler angles at the instant of an event			E
Differential Correction Blocks					
DiffCorrIn	5919	Incoming RTCM or CMR message			R
BaseStation	5949	Base station coordinates			R
RTCMDatum	4049	Datum information from the RTK service provider			R
L-Band Demodulator Blocks					
LBandTrackerStatus	4201	Status of the L-band signal tracking	•	•	R
LBandBeams	4204	L-band satellite/beam information		•	R
Status Blocks					
ChannelStatus	4013	Status of the tracking for all receiver channels	•	•	R
ReceiverStatus	4014	Overall status information of the receiver	•	•	R
SatVisibility	4012	Azimuth/elevation of visible satellites	•	•	R
InputLink	4090	Statistics on input streams	•	•	R
OutputLink	4091	Statistics on output streams	•	•	R
NTRIPClientStatus	4053	NTRIP client connection status	•	•	R
NTRIPServerStatus	4122	NTRIP server connection status	•	•	R
IPStatus	4058	IP address, gateway and MAC address of Ethernet interface		•	R
DynDNSStatus	4105	DynDNS status	•	•	R
QualityInd	4082	Quality indicators	•	•	R
DiskStatus	4059	Internal logging status	•	•	R
RFStatus	4092	Radio-frequency interference mitigation status	•	•	R

Block name	Block No	Content description	Flex Rate	esoc	Time Stamp
P2PPStatus	4238	P2PP client/server status	•	•	R
CosmosStatus	4243	Cosmos receiver service status	•	•	R
Miscellaneous Blocks					
ReceiverSetup	5902	General information about the receiver installation		•	R
RxMessage	4103	Receiver message		•	R
Commands	4015	Commands entered by the user		•	R
Comment	5936	Comment entered by the user		•	R
BBSamples	4040	Baseband samples			E
ASCIIn	4075	ASCII input from external sensor			R
EncapsulatedOutput	4097	SBF encapsulation of non-SBF messages			R
PinPoint-GIS RX					
GISAction	4106	PinPoint-GIS RX Action			R
GISStatus	4107	Status of the different PinPoint-GIS collection databases	•	•	R

Appendix C

List of NMEA Sentences

The following table provides a list of the NMEA messages supported by your receiver. The first column is the message identifier to be used in the **setNMEAOutput** and the **exeNMEAOnce** commands.

For a full description of the NMEA messages, please refer to the NMEA 0183 standard.

Message Identifier	NMEA For-matter	Short Description	Comment
ALM	ALM	GPS Almanac Data	
AVR	AVR	Trimble Navigation proprietary \$PTNL, AVR sentence	
DTM	DTM	Datum Reference	
GBS	GBS	GNSS Satellite Fault Detection	
GFA	GFA	GNSS Fix Accuracy and Integrity	
GGA	GGA	GPS Fix Data	
GGK	GGK	Trimble Navigation proprietary \$PTNL, GGK sentence	
GGQ	GGQ	Leica Real-Time Position with CQ	
GLL	GLL	Geographic Position - Latitude/Longitude	
GMP	GMP	GNSS Map Projection Fix Data	
GNS	GNS	GNSS Fix Data	
GRS	GRS	GNSS Range Residuals	
GSA	GSA	GNSS DOP and Active Satellites	
GST	GST	GNSS Pseudorange Error Statistics	
GSV	GSV	GNSS Satellites in View	
HDT	HDT	Heading, True	
HRP	HRP	Heading, Roll, Pitch	Septentrio proprietary, see section C.1.1
LLK	LLK	Leica Local Position and GDOP	
LLQ	LLQ	Leica Local Position and Quality	
RBD	RBD	Rover-Base Direction	Septentrio proprietary, see section C.1.2
RBP	RBP	Rover-Base Position	Septentrio proprietary, see section C.1.3
RBV	RBV	Rover-Base Velocity	Septentrio proprietary, see section C.1.4
RMC	RMC	Recommended Minimum Specific GNSS Data	

Message Identifier	NMEA For-matter	Short Description	Comment
ROT	ROT	Rate of Turn	
SNC	SNC	NTRIP Client Status	Septentrio proprietary, see section C.1.5
TFM	TFM	Used Coordinate Transformation Messages	Septentrio proprietary, see section C.1.6
THS	THS	True Heading and Status	
TXTbase	TXT	Text Transmission	Text from a base station in RTCM message type 1029. The text identifier is set to 1, and the text message is in the form "nnnn:<base txt>", where nnnn is the base station ID.
VTG	VTG	Course Over Ground and Ground Speed	
ZDA	ZDA	Time and Date	

Note: in sentences containing satellite-per-satellite data, data for BeiDou satellites are encoded using System ID 4 (BD) and satellite ID 1-36. Data for NavIC/IRNSS, QZSS and SBAS satellites with a PRN>151 are not encoded in NMEA.

Appendix C.1 Proprietary NMEA Sentences

C.1.1 HRP : Heading, Roll Pitch

Field	Description
\$PSSN,HRP,	Start of sentence
hhmmss.ss,	UTC of HRP (HoursMinutesSeconds.DecimalSeconds)
xxxxxx,	Date: ddmmyy
x.x,	Heading, degrees True
x.x,	Roll, degrees
x.x,	Pitch, degrees
x.x,	Heading standard deviation, degrees
x.x,	Roll standard deviation, degrees
x.x,	Pitch standard deviation, degrees
xx,	Number of satellites used for attitude computation
x,	Mode indicator: 0: No attitude available 1: Heading, Pitch with float ambiguities 2: Heading, Pitch with fixed ambiguities 3: Heading, Pitch, Roll with float ambiguities 4: Heading, Pitch, Roll with fixed ambiguities 5: Heading, Pitch from velocity (dead-reckoning)
x.x,a	Magnetic variation, degrees (E=East, W=West, see also the setMagneticVariance command)
*hh	Checksum delimiter and checksum field
<CR><LF>	End of sentence

C.1.2 RBD : Rover-Base Direction

Field	Description
\$PSSN,RBD,	Start of sentence
hhmmss.ss,	UTC of RBD (HoursMinutesSeconds.DecimalSeconds)
xxxxxx,	Date: ddmmyy
x.x,	Azimuth of the base as seen from rover (0 to 360 increasing towards east), degrees True
x.x,	Elevation of the base as seen from rover (-90 to 90), degrees
xx,	Number of satellites used for baseline computation
x,	Quality indicator: 0: Invalid 2: DPGS 4: RTK 5: Float RTK
x,	Base motion indicator: 0: Static base 1: Moving base
x.x,	Correction Age, seconds
C-c,	Rover serial number
xxxx	Base station ID
*hh	Checksum delimiter and checksum field
<CR><LF>	End of sentence

C.1.3 RBP : Rover-Base Position

Field	Description
\$PSSN,RBP,	Start of sentence
hhmmss.ss,	UTC of RBP (HoursMinutesSeconds.DecimalSeconds)
xxxxxx,	Date: ddmmyy
x.x,	North (True) baseline component (positive when base is north of rover), meters
x.x,	East baseline component (positive when base is east of rover), meters
x.x,	Up baseline component (positive when base is higher than rover), meters
xx,	Number of satellites used for baseline computation
x,	Quality indicator: 0: Invalid 2: DPGS 4: RTK 5: Float RTK
x,	Base motion indicator: 0: Static base 1: Moving base
x.x,	Correction Age, seconds
C-c,	Rover serial number
xxxx	Base station ID
*hh	Checksum delimiter and checksum field
<CR><LF>	End of sentence

C.1.4 RBV : Rover-Base Velocity

Field	Description
\$PSSN,RBV,	Start of sentence
hhmmss.ss,	UTC of RBV (HoursMinutesSeconds.DecimalSeconds)
xxxxxx,	Date: ddmmyy
x.x,	Rate of change of baseline vector (rover to base), north component, m/s
x.x,	Rate of change of baseline vector (rover to base), east component, m/s
x.x,	Rate of change of baseline vector (rover to base), up component, m/s
xx,	Number of satellites used for baseline computation
x,	Quality indicator: 0: Invalid 2: DPGS 4: RTK 5: Float RTK
x,	Base motion indicator: 0: Static base 1: Moving base
x.x,	Correction Age, seconds
c-c,	Rover serial number
xxxx	Base station ID
*hh	Checksum delimiter and checksum field
<CR><LF>	End of sentence

C.1.5 SNC : NTRIP Client Status

This proprietary sentence is the NMEA equivalent of the `NTRIPClientStatus` SBF block.

Field	Description
\$PSSN,SNC,	Start of sentence
[
x,	message revision
xxxxxxxxx,	time of week, milliseconds
xxxx,	week number
<SNCSub>	a succession of <code>SNCSub</code> sub-messages, see definition below
]	
*hh	Checksum delimiter and checksum field
<CR><LF>	End of sentence

`SNCSub` definition:

Field	Description
[
x,	<code>CDIndex</code> field of the <code>NTRIPClientStatus</code> SBF block
x,	<code>Status</code> field of the <code>NTRIPClientStatus</code> SBF block
x,	<code>ErrorCode</code> field of the <code>NTRIPClientStatus</code> SBF block
x	<code>Info</code> field of the <code>NTRIPClientStatus</code> SBF block
]	

Example:

```
$PSSN,SNC,[0,379359000,1840,[1,2,0,0]]*68
```

C.1.6 TFM : Used RTCM Coordinate Transformation Messages

This proprietary sentence indicates which RTCM coordinate transformation messages have been received and used in the position computation.

Field	Description
\$PSSN,TFM,	Start of sentence
hhmmss.ss,	UTC time (HoursMinutesSeconds.DecimalSeconds)
x,	Height indicator, a copy of the Height Indicator field in RTCM message 1021 or 1022. Null if unknown.
xxxx,	Message 1021/1022 usage (they are exclusive). Possible field values: 1021: Message type 1021 used; 1022: Message type 1022 used; null: neither 1021 nor 1022 used.
xxxx,	Message 1023/1024 usage (they are exclusive). Possible field values: 1023: Message type 1023 used; 1024: Message type 1024 used; null: neither 1023 nor 1024 used.
xxxx	Message 1025/1026/1027 usage (they are exclusive). Possible field values: 1025: Message type 1025 used; 1026: Message type 1026 used; 1027: Message type 1027 used; null: neither 1025 nor 1026 nor 1027 used.
*hh	Checksum delimiter and checksum field
<CR><LF>	End of sentence

Example:

```
$PSSN,TFM,104751.00,2,1021,1023,1025*5F
```

Appendix D

List of CMR and RTCM Messages

This appendix provides a list of all the CMR and RTCM (v2.x and v3.x) messages supported by the receiver.

Appendix D.1 CMR Messages

Message Identifier	Short Description
CMR0	Observables
CMR1	Reference Station Coordinates
CMR2	Reference Station Description
CMR3	GLONASS Observables
CMR0p	CMR+ variant
CMR0w	CMR-W variant

Appendix D.2 RTCM v2.x Messages

Message Identifier	Short Description
RTCM1	Differential GPS Corrections
RTCM3	GPS Reference Station Parameters
RTCM9	GPS Partial Correction Set
RTCM15	Ionospheric Delay
RTCM16	GPS Special Message
RTCM17	GPS Ephemerides Message
RTCM18	RTK Uncorrected Carrier Phases
RTCM19	RTK Uncorrected Pseudoranges
RTCM20	RTK Carrier Phase Corrections
RTCM21	RTK/Hi-Accuracy Pseudorange Corrections
RTCM22	Extended Reference Station Parameters
RTCM23	Antenne Type Definition Record
RTCM24	Antenna Reference Point (ARP)
RTCM31	Differential GLONASS Corrections

Message Identifier	Short Description
RTCM32	GLONASS Reference Station Parameters
RTCM34	GLONASS Partial Correction Set
RTCM59	Proprietary Message

Appendix D.3 RTCM v3.x Messages

Message Identifier	Short Description
RTCM1001	L1-Only GPS RTK Observables
RTCM1002	Extended L1-Only GPS RTK Observables
RTCM1003	L1&L2 GPS RTK Observables
RTCM1004	Extended L1&L2 GPS RTK Observables
RTCM1005	Stationary RTK Reference Station ARP
RTCM1006	Stationary RTK Reference Station ARP with Antenna Height
RTCM1007	Antenna Descriptor
RTCM1008	Antenna Descriptor and Serial Number
RTCM1009	L1-Only GLONASS RTK Observables
RTCM1010	Extended L1-Only GLONASS RTK Observables
RTCM1011	L1&L2 GLONASS RTK Observables
RTCM1012	Extended L1&L2 GLONASS RTK Observables
RTCM1013	System Parameters
RTCM1015	Network RTK (MAC), GPS Ionospheric Correction Differences
RTCM1016	Network RTK (MAC), GPS Geometric Correction Differences
RTCM1017	Network RTK (MAC), GPS Combined Geometric and Ionospheric Correction Differences
RTCM1019	GPS Satellite Ephemeris Data
RTCM1020	Glomass Satellite Ephemeris Data
RTCM1021	Helmert-Abridged Molodenski Transformation Parameters
RTCM1022	Molodenski-Badekas Transformation Parameters
RTCM1023	Residuals, Ellipsoidal Grid Representation
RTCM1024	Residuals, Plane Grid Representation
RTCM1025	Projection Parameters, Projection Types other than Lambert Conic Conformal (2 SP) and Oblique Mercator
RTCM1026	Projection Parameters, Projection Type LCC2SP (Lambert Conic Conformal (2 SP))
RTCM1027	Projection Parameters, Projection Type OM (Oblique Mercator)
RTCM1029	Unicode Text String
RTCM1033	Receiver and Antenna Descriptors
RTCM1037	Network RTK (MAC), GLONASS Ionospheric Correction Differences
RTCM1038	Network RTK (MAC), GLONASS Geometric Correction Differences
RTCM1039	Network RTK (MAC), GLONASS Combined Geometric and Ionospheric Correction Differences
RTCM1042	BDS Satellite Ephemeris Data
RTCM1044	QZSS Satellite Ephemeris Data
RTCM1045	Galileo F/NAV Satellite Ephemeris Data
RTCM1046	Galileo I/NAV Satellite Ephemeris Data
RTCM1071	GPS MSM1, Compact Pseudoranges
RTCM1072	GPS MSM2, Compact PhaseRanges
RTCM1073	GPS MSM3, Compact Pseudoranges and PhaseRanges

Message Identifier	Short Description
RTCM1074	GPS MSM4, Full Pseudoranges and PhaseRanges plus CNR
RTCM1075	GPS MSM5, Full Pseudoranges, PhaseRanges, PhaseRangeRate and CNR
RTCM1076	GPS MSM6, Full Pseudoranges and PhaseRanges plus CNR (high resolution)
RTCM1077	GPS MSM7, Full Pseudoranges, PhaseRanges, PhaseRangeRate and CNR (high resolution)
RTCM1081	GLONASS MSM1, Compact Pseudoranges
RTCM1082	GLONASS MSM2, Compact PhaseRanges
RTCM1083	GLONASS MSM3, Compact Pseudoranges and PhaseRanges
RTCM1084	GLONASS MSM4, Full Pseudoranges and PhaseRanges plus CNR
RTCM1085	GLONASS MSM5, Full Pseudoranges, PhaseRanges, PhaseRangeRate and CNR
RTCM1086	GLONASS MSM6, Full Pseudoranges and PhaseRanges plus CNR (high resolution)
RTCM1087	GLONASS MSM7, Full Pseudoranges, PhaseRanges, PhaseRangeRate and CNR (high resolution)
RTCM1091	Galileo MSM1, Compact Pseudoranges
RTCM1092	Galileo MSM2, Compact PhaseRanges
RTCM1093	Galileo MSM3, Compact Pseudoranges and PhaseRanges
RTCM1094	Galileo MSM4, Full Pseudoranges and PhaseRanges plus CNR
RTCM1095	Galileo MSM5, Full Pseudoranges, PhaseRanges, PhaseRangeRate and CNR
RTCM1096	Galileo MSM6, Full Pseudoranges and PhaseRanges plus CNR (high resolution)
RTCM1097	Galileo MSM7, Full Pseudoranges, PhaseRanges, PhaseRangeRate and CNR (high resolution)
RTCM1101	SBAS MSM1, Compact Pseudoranges
RTCM1102	SBAS MSM2, Compact PhaseRanges
RTCM1103	SBAS MSM3, Compact Pseudoranges and PhaseRanges
RTCM1104	SBAS MSM4, Full Pseudoranges and PhaseRanges plus CNR
RTCM1105	SBAS MSM5, Full Pseudoranges, PhaseRanges, PhaseRangeRate and CNR
RTCM1106	SBAS MSM6, Full Pseudoranges and PhaseRanges plus CNR (high resolution)
RTCM1107	SBAS MSM7, Full Pseudoranges, PhaseRanges, PhaseRangeRate and CNR (high resolution)
RTCM1111	QZSS MSM1, Compact Pseudoranges
RTCM1112	QZSS MSM2, Compact PhaseRanges
RTCM1113	QZSS MSM3, Compact Pseudoranges and PhaseRanges
RTCM1114	QZSS MSM4, Full Pseudoranges and PhaseRanges plus CNR
RTCM1115	QZSS MSM5, Full Pseudoranges, PhaseRanges, PhaseRangeRate and CNR
RTCM1116	QZSS MSM6, Full Pseudoranges and PhaseRanges plus CNR (high resolution)
RTCM1117	QZSS MSM7, Full Pseudoranges, PhaseRanges, PhaseRangeRate and CNR (high resolution)
RTCM1121	BeiDou MSM1, Compact Pseudoranges
RTCM1122	BeiDou MSM2, Compact PhaseRanges
RTCM1123	BeiDou MSM3, Compact Pseudoranges and PhaseRanges
RTCM1124	BeiDou MSM4, Full Pseudoranges and PhaseRanges plus CNR
RTCM1125	BeiDou MSM5, Full Pseudoranges, PhaseRanges, PhaseRangeRate and CNR
RTCM1126	BeiDou MSM6, Full Pseudoranges and PhaseRanges plus CNR (high resolution)
RTCM1127	BeiDou MSM7, Full Pseudoranges, PhaseRanges, PhaseRangeRate and CNR (high resolution)
RTCM1131	NavIC/IRNSS MSM1, Compact Pseudoranges
RTCM1132	NavIC/IRNSS MSM2, Compact PhaseRanges
RTCM1133	NavIC/IRNSS MSM3, Compact Pseudoranges and PhaseRanges
RTCM1134	NavIC/IRNSS MSM4, Full Pseudoranges and PhaseRanges plus CNR
RTCM1135	NavIC/IRNSS MSM5, Full Pseudoranges, PhaseRanges, PhaseRangeRate and CNR
RTCM1136	NavIC/IRNSS MSM6, Full Pseudoranges and PhaseRanges plus CNR (high resolution)

Message Identifier	Short Description
RTCM1137	NavIC/IRNSS MSM7, Full Pseudoranges, PhaseRanges, PhaseRangeRate and CNR (high resolution)
RTCM1230	GLONASS L1&L2 Code-Phase Biases

Index of Commands

A

AGCMode

setAGCMode, getAGCMode
sam, gam, 96

AntennaInfo

lstAntennaInfo
lai, 61

AntennaLocation

setAntennaLocation, getAntennaLocation
sal, gal, 125

AntennaOffset

setAntennaOffset, getAntennaOffset
sao, gao, 100

AttitudeOffset

setAttitudeOffset, getAttitudeOffset
sto, gto, 126

B

BBSamplingMode

setBBSamplingMode, getBBSamplingMode
sbbs, gbbs, 97

C

ChannelAllocation

setChannelAllocation, getChannelAllocation
sca, gca, 84

CheckInternetAvailability

setCheckInternetAvailability, getCheckInternetAvailability
scia, gcia, 146

ClearCollectDatabase

exeClearCollectDatabase, getClearCollectDatabase
eccd, gccd, 222

ClockSyncThreshold

setClockSyncThreshold, getClockSyncThreshold
scst, gcst, 137

CMRv2Formatting

setCMRv2Formatting, getCMRv2Formatting
sc2f, gc2f, 200

CMRv2Interval

setCMRv2Interval, getCMRv2Interval
sc2i, gc2i, 201

CMRv2Message2
setCMRv2Message2, getCMRv2Message2
sc2m, gc2m, 202

CMRv2Output
setCMRv2Output, getCMRv2Output
sc2o, gc2o, 203

CMRv2Usage
setCMRv2Usage, getCMRv2Usage
sc2u, gc2u, 204

CN0Mask
setCN0Mask, getCN0Mask
scm, gcm, 86

CollectDBAppData
setCollectDBAppData, getCollectDBAppData
scdd, gcdd, 223

CollectDBAttributes
setCollectDBAttributes, getCollectDBAttributes
scdt, gcdd, 224

CollectDBProperties
setCollectDBProperties, getCollectDBProperties
scdo, gcdo, 225

CollectedItems
IstCollectedItems
lci, 226

CollectPlaceholders
IstCollectPlaceholders
lcp, 227

CollectPoint
exeCollectPoint, getCollectPoint
ecp, gcp, 228

CommandHelp
IstCommandHelp
help, 62

COMSettings
setCOMSettings, getCOMSettings
scs, gcs, 147

ConfigFile
IstConfigFile
lcf, 63

CopyConfigFile
exeCopyConfigFile, getCopyConfigFile
eccf, gccf, 64

CosmosConfig
setCosmosConfig, getCosmosConfig
scoc, gcoc, 232

CrossDomainWebAccess
setCrossDomainWebAccess, getCrossDomainWebAccess
scda, gcda, 148

CurrentUser
IstCurrentUser
lcu, 79

D

- DaisyChainMode
 - setDaisyChainMode, getDaisyChainMode
 - sdcm, gdcn, 149
- DataInOut
 - setDataInOut, getDataInOut
 - sdio, gdio, 150
- DefaultAccessLevel
 - setDefaultAccessLevel, getDefaultAccessLevel
 - sdal, gdal, 80
- DeletePoint
 - exeDeletePoint, getDeletePoint
 - edp, gdp, 229
- DiffCorrMaxAge
 - setDiffCorrMaxAge, getDiffCorrMaxAge
 - sdca, gdca, 101
- DiffCorrUsage
 - setDiffCorrUsage, getDiffCorrUsage
 - sdcu, gdcu, 102
- DiskFullAction
 - setDiskFullAction, getDiskFullAction
 - sdfa, gdfa, 205
- DiskInfo
 - lstDiskInfo
 - ldi, 206
- DynamicDNS
 - setDynamicDNS, getDynamicDNS
 - sdds, gdds, 152

E

- EchoMessage
 - exeEchoMessage, getEchoMessage
 - eecm, gecm, 153
- ElevationMask
 - setElevationMask, getElevationMask
 - sem, gem, 103
- ENHTransfoHorizontal
 - setENHTransfoHorizontal, getENHTransfoHorizontal
 - smth, gmth, 133
- ENHTransfoVertical
 - setENHTransfoVertical, getENHTransfoVertical
 - smtv, gmtv, 134
- EthernetMode
 - setEthernetMode, getEthernetMode
 - seth, geth, 65
- EventParameters
 - setEventParameters, getEventParameters
 - sep, gep, 138

F

- FileNaming
 - setFileNaming, getFileNaming

sfn, gfn, 207
FTPPushRINEX
 setFTPPushRINEX, getFTPPushRINEX
 sfpr, gfpr, 216
FTPPushSBF
 setFTPPushSBF, getFTPPushSBF
 sfps, gfps, 217
FTPPushTest
 exeFTPPushTest, getFTPPushTest
 efpt, gfpt, 218
FTPUpgrade
 exeFTPUpgrade, getFTPUpgrade
 efup, gfup, 66

G

GeodeticDatum
 setGeodeticDatum, getGeodeticDatum
 sgd, ggd, 128
GeoidUndulation
 setGeoidUndulation, getGeoidUndulation
 sgu, ggu, 104
GlobalFileNamingOptions
 setGlobalFileNamingOptions, getGlobalFileNamingOptions
 sfno, gfno, 209
GNSSAttitude
 setGNSSAttitude, getGNSSAttitude
 sga, gga, 127
GPIOFunctionality
 setGPIOFunctionality, getGPIOFunctionality
 sgpf, ggpf, 67

H

HealthMask
 setHealthMask, getHealthMask
 shm, ghm, 105
HttpsSettings
 setHttpsSettings, getHttpsSettings
 shs, ghs, 155

I

InternalFile
 IstInternalFile
 lif, 68
IonosphereModel
 setIonosphereModel, getIonosphereModel
 sim, gim, 106
IPFiltering
 setIPFiltering, getIPFiltering
 sipf, gipf, 156
IPPortSettings
 setIPPortSettings, getIPPortSettings
 sipp, gipp, 157
IPReceiveSettings

setIPReceiveSettings, getIPReceiveSettings
sirs, girs, 158

IPServerSettings

setIPServerSettings, getIPServerSettings
siss, giss, 159

IPSettings

setIPSettings, getIPSettings
sips, gips, 160

L

LBandBeams

setLBandBeams, getLBandBeams
slbb, glbb, 219

LBandCustomServiceID

setLBandCustomServiceID, getLBandCustomServiceID
slcs, glcs, 220

LBandSelectMode

setLBandSelectMode, getLBandSelectMode
slsm, glsm, 221

LEDMode

setLEDMode, getLEDMode
slm, glm, 69

LocalCoordOperation

setLocalCoordOperation, getLocalCoordOperation
slco, glco, 135

LocalCoordOperations

lstLocalCoordOperations
llc, 136

LogIn

LogIn
login, 81

LogOut

LogOut
logout, 82

M

MagneticVariance

setMagneticVariance, getMagneticVariance
smv, gmv, 108

ManageDisk

exeManageDisk, getManageDisk
emd, gmd, 210

MarkerParameters

setMarkerParameters, getMarkerParameters
smp, gmp, 143

Meas3MaxRefInterval

setMeas3MaxRefInterval, getMeas3MaxRefInterval
smrf, gmrf, 178

MIBDescription

lstMIBDescription
lmd, 70

MultipathMitigation

setMultipathMitigation, getMultipathMitigation
smm, gmm, 87

N

NetworkRTKConfig

setNetworkRTKConfig, getNetworkRTKConfig
snrc, gnrc, 109

NMEAOnce

exeNMEAOnce, getNMEAOnce
enoc, gnoc, 172

NMEAOutput

setNMEAOutput, getNMEAOutput
sno, gno, 173

NMEAPrecision

setNMEAPrecision, getNMEAPrecision
snp, gnp, 175

NMEATalkerID

setNMEATalkerID, getNMEATalkerID
snti, gnti, 176

NMEAVersion

setNMEAVersion, getNMEAVersion
snv, gnv, 177

NotchFiltering

setNotchFiltering, getNotchFiltering
snf, gnf, 98

NTPServer

setNTPServer, getNTPServer
sntp, gntp, 139

NtripCasterMountPoints

setNtripCasterMountPoints, getNtripCasterMountPoints
snmp, gnmp, 165

NtripCasterMPFormat

setNtripCasterMPFormat, getNtripCasterMPFormat
smpf, gmpf, 166

NtripCasterSettings

setNtripCasterSettings, getNtripCasterSettings
snsc, gnsc, 167

NtripCasterUsers

setNtripCasterUsers, getNtripCasterUsers
sncu, gncu, 168

NtripSettings

setNtripSettings, getNtripSettings
snst, gnst, 169

NTRIPSourceTable

IstNTRIPSourceTable
Inst, 170

NtripTlsSettings

setNtripTlsSettings, getNtripTlsSettings
snstt, gnstt, 171

O

ObserverComment

setObserverComment, getObserverComment
soc, goc, 144

ObserverParameters

setObserverParameters, getObserverParameters
sop, gop, 145

P

PeriodicEcho

setPeriodicEcho, getPeriodicEcho
spe, gpe, 161

PointToPoint

setPointToPoint, getPointToPoint
sp2p, gp2p, 163

PortFirewall

setPortFirewall, getPortFirewall
spfw, gpfw, 164

PowerMode

exePowerMode, getPowerMode
epwm, gpwm, 78

PPSPParameters

setPPSPParameters, getPPSPParameters
spps, gpps, 140

PVTMode

setPVTMode, getPVTMode
spm, gpm, 110

R

RAIMLevels

setRAIMLevels, getRAIMLevels
srl, grl, 112

ReceiverCapabilities

getReceiverCapabilities
grc, 71

ReceiverDynamics

setReceiverDynamics, getReceiverDynamics
srd, grd, 113

ReceiverInterface

getReceiverInterface
gri, 74

RecordedFile

lstRecordedFile
lrf, 211

RegisteredApplications

exeRegisteredApplications, getRegisteredApplications
era, gra, 75

RemoveFile

exeRemoveFile, getRemoveFile
erf, grf, 212

ResetNavFilter

exeResetNavFilter, getResetNavFilter
ernf, grnf, 114

ResetReceiver

exeResetReceiver, getResetReceiver
erst, grst, 76

RINEXLogging
setRINEXLogging, getRINEXLogging
srxl, grxl, 213

RTCMv2Compatibility
setRTCMv2Compatibility, getRTCMv2Compatibility
sr2c, gr2c, 185

RTCMv2Formatting
setRTCMv2Formatting, getRTCMv2Formatting
sr2f, gr2f, 186

RTCMv2Interval
setRTCMv2Interval, getRTCMv2Interval
sr2i, gr2i, 187

RTCMv2IntervalObs
setRTCMv2IntervalObs, getRTCMv2IntervalObs
sr2b, gr2b, 188

RTCMv2Message16
setRTCMv2Message16, getRTCMv2Message16
sr2m, gr2m, 189

RTCMv2Output
setRTCMv2Output, getRTCMv2Output
sr2o, gr2o, 190

RTCMv2Usage
setRTCMv2Usage, getRTCMv2Usage
sr2u, gr2u, 191

RTCMv3CRSTransfo
setRTCMv3CRSTransfo, getRTCMv3CRSTransfo
sr3t, gr3t, 192

RTCMv3Delay
setRTCMv3Delay, getRTCMv3Delay
sr3d, gr3d, 193

RTCMv3Formatting
setRTCMv3Formatting, getRTCMv3Formatting
sr3f, gr3f, 194

RTCMv3Interval
setRTCMv3Interval, getRTCMv3Interval
sr3i, gr3i, 195

RTCMv3Message1029
setRTCMv3Message1029, getRTCMv3Message1029
sr3m, gr3m, 196

RTCMv3Output
setRTCMv3Output, getRTCMv3Output
sr3o, gr3o, 197

RTCMv3Usage
setRTCMv3Usage, getRTCMv3Usage
sr3u, gr3u, 199

S

SatelliteTracking
setSatelliteTracking, getSatelliteTracking
sst, gst, 88

SatelliteUsage

setSatelliteUsage, getSatelliteUsage
ssu, gsu, 115

SBASCorrections

setSBASCorrections, getSBASCorrections
ssbc, gsbc, 116

SBFGroups

setSBFGroups, getSBFGroups
ssgp, gsgp, 179

SBFOnce

exeSBFOnce, getSBFOnce
esoc, gsoc, 180

SBFOutput

setSBFOutput, getSBFOutput
sso, gso, 182

SignalTracking

setSignalTracking, getSignalTracking
snt, gnt, 90

SignalUsage

setSignalUsage, getSignalUsage
snu, gnu, 118

SmoothingInterval

setSmoothingInterval, getSmoothingInterval
ssi, gsi, 92

StaticPosCartesian

setStaticPosCartesian, getStaticPosCartesian
sspc, gspc, 119

StaticPosGeodetic

setStaticPosGeodetic, getStaticPosGeodetic
sspg, gspg, 121

T**TimeSyncSource**

setTimeSyncSource, getTimeSyncSource
stss, gtss, 141

TimingSystem

setTimingSystem, getTimingSystem
sts, gts, 142

TrackingLoopParameters

setTrackingLoopParameters, getTrackingLoopParameters
stlp, gtlp, 94

TroposphereModel

setTroposphereModel, getTroposphereModel
stm, gtm, 122

TroposphereParameters

setTroposphereParameters, getTroposphereParameters
stp, gtp, 124

U**UMSDOnConnect**

setUMSDOnConnect, getUMSDOnConnect
suoc, guoc, 215

UpdatePoint

exeUpdatePoint, getUpdatePoint
eup, gup, 230

UserAccessLevel

setUserAccessLevel, getUserAccessLevel
sual, gual, 83

UserDatum

setUserDatum, getUserDatum
sud, gud, 130

UserDatumVel

setUserDatumVel, getUserDatumVel
sudv, gudv, 131

UserEllipsoid

setUserEllipsoid, getUserEllipsoid
sue, gue, 132

W**WBIMitigation**

setWBIMitigation, getWBIMitigation
swbi, gwbi, 99

WriteCollectCsvFile

exeWriteCollectCsvFile, getWriteCollectCsvFile
ewcf, gwcf, 231

Index of SBF Blocks

ASCIIn, 407
AttCovEuler, 349
AttEuler, 348

BaseStation, 371
BaseVectorCart, 339
BaseVectorGeod, 342
BBSamples, 406
BDSAlm, 290
BDSIon, 291
BDSNav, 288
BDSRaw, 264
BDSRawB1C, 265
BDSRawB2a, 266
BDSUtc, 292

ChannelStatus, 376
Commands, 404
Comment, 405
CosmosStatus, 400

DiffCorrIn, 368
DiskStatus, 396
DOP, 330
DynDNSStatus, 394

EncapsulatedOutput, 408
EndOfAtt, 350
EndOfMeas, 255
EndOfPVT, 347
ExtEvent, 354
ExtEventAttEuler, 366
ExtEventBaseVectGeod, 363
ExtEventPVTCartesian, 355
ExtEventPVTGeodetic, 359

GALAlm, 282
GALGstGps, 286
GALIon, 284
GALNav, 279
GALRawFNAV, 260
GALRawINAV, 261

GALSARRLM, 287
GALUtc, 285
GEOAlm, 304
GEOClockEphCovMatrix, 309
GEODegrFactors, 302
GEOFastCorr, 298
GEOFastCorrDegr, 300
GEOIGPMask, 305
GEOIntegrity, 299
GEOIonoDelay, 307
GEOLongTermCorr, 306
GEOMT00, 296
GEONav, 301
GEONetworkTime, 303
GEOPRNMask, 297
GEORawL1, 262
GEORawL5, 263
GEOServiceLevel, 308
GISAction, 409
GISStatus, 410
GLOAlm, 277
GLONav, 276
GLORawCA, 259
GLOTime, 278
GPSAlm, 273
GPSIon, 274
GPSNav, 271
GPSRawCA, 256
GPSRawL2C, 257
GPSRawL5, 258
GPSUtc, 275

InputLink, 384
IPStatus, 393

LBandBeams, 375
LBandTrackerStatus, 373

Meas3CN0HiRes, 251
Meas3Doppler, 252
Meas3MP, 254
Meas3PP, 253
Meas3Ranges, 250
MeasEpoch, 242
MeasExtra, 247

NAVICRaw, 270
NTRIPClientStatus, 390
NTRIPServerStatus, 392

OutputLink, 387

P2PPStatus, 399
PosCart, 331

PosCovCartesian, 318
PosCovGeodetic, 321
PosLocal, 335
PosProjected, 337
PVTCartesian, 310
PVTGeodetic, 314
PVTSupport, 345
PVTSupportA, 346

QualityInd, 395
QZSAlm, 295
QZSNav, 293
QZSRawL1CA, 267
QZSRawL2C, 268
QZSRawL5, 269

ReceiverSetup, 401
ReceiverStatus, 379
ReceiverTime, 351
RFStatus, 398
RTCMDatum, 372
RxMessage, 403

SatVisibility, 383

VelCovCartesian, 324
VelCovGeodetic, 327

xPPSOffset, 352