

SF2349D

912.1 MHz SAW Filter

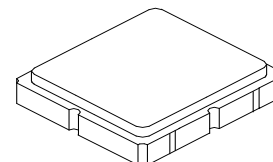

SM3838-6

- 912.1 MHz RF SAW Filter
- 3.8 x 3.8 x 1.25 mm Surface-mount Package
- Complies with Directive 2002/95/EC (RoHS)
- Moisture Sensitivity Level: 1

Absolute Maximum Ratings

Rating	Value	Units
Maximum Input Power Level	+10	dBm
Maximum DC Voltage Between any Two Terminals	5	VDC
Operable Temperature Range	-45 to +125	°C
Specification Temperature Range	-20 to +65	°C
Storage Temperature Range	-40 to +85	°C
Suitable for Lead-free Soldering - Maximum Soldering Profile	260°C for 30 s	

Electrical Characteristics

Characteristic	Sym	Notes	Min	Typ	Max	Units
Center Frequency	f_c	1		912.1		MHz
Insertion Loss, 907.0 to 917.2 MHz	IL			2.95	4.1	dB
Amplitude Ripple 907.0 to 917.2 MHz				0.5	1.8	
Rejection Referenced to 0 dB:						
10 to 830 MHz		1, 2, 3	40	48		dB
830 to 890 MHz			30	41		
890 to 894 MHz			15			
930 to 960 MHz			14	27		
960 to 1200 MHz			40	46		
Single-ended Source Impedance			50 ohm			
Single-ended Load Impedance			50 ohm			

Case Style	SM3838-6 3.8 x 3.8 mm Nominal Footprint		
Lid Symbolization (Y=year, WW=week, S=shift) dot=pin 1 indicator	B17, YWWS		
Standard Reel Quantity	Reel Size 7 Inch	500 Pieces/Reel	
	Reel Size 13 Inch	3000 Pieces/Reel	

Electrical Connections

Connection	Terminals
Port 1	2
Port 2	5
Case Ground	All others

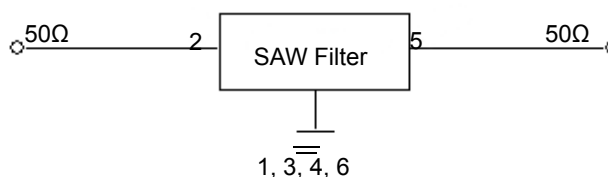

 **CAUTION: Electrostatic Sensitive Device. Observe precautions for handling.**

NOTES:

1. The design, manufacturing process, and specifications of this device are subject to change.
2. US or International patents may apply.
3. RoHS compliant from the first date of manufacture.

Transfer Function

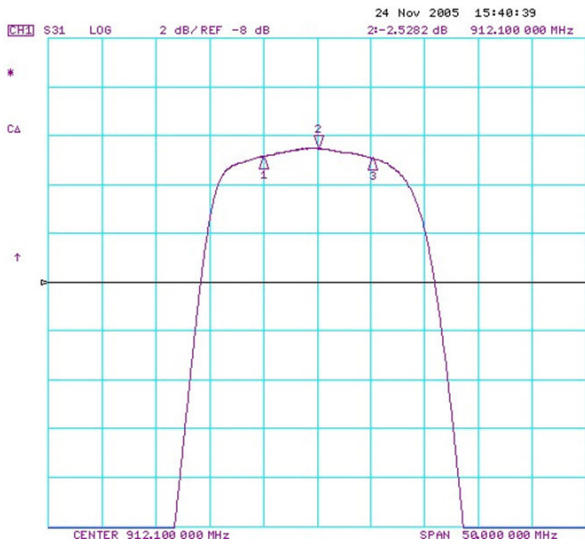

Wideband

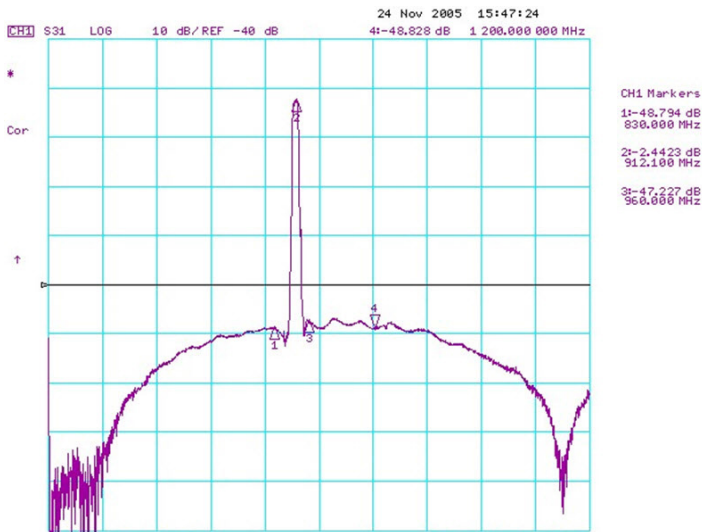

SM3838-6 Case

6-Terminal Ceramic Surface-Mount Case

3.8 X 3.8 mm Nominal Footprint

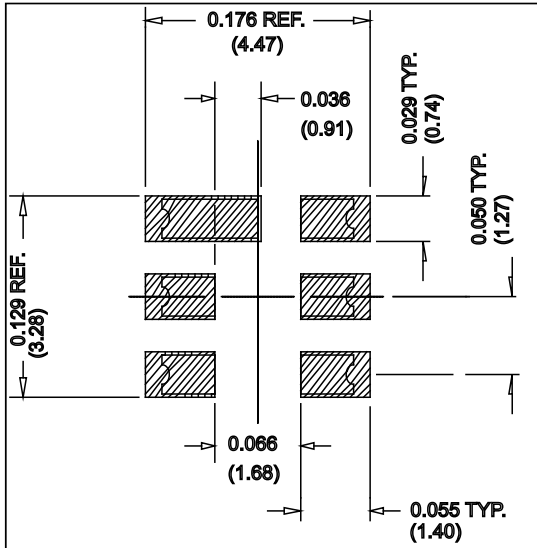
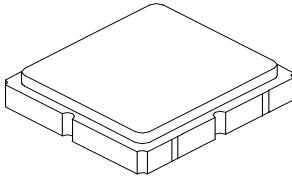

PCB Footprint

Dimension	Case Dimensions					
	mm			Inches		
	Min	Nom	Max	Min	Nom	Max
A	3.60	3.80	4.0	0.14	0.15	0.16
B	3.60	3.80	4.0	0.14	0.15	0.16
C	1.30	1.50	1.70	0.05	0.06	0.067
D	0.95	1.10	1.25	0.037	0.043	0.05
E	2.39	2.54	2.69	0.090	0.10	0.110
G	0.90	1.0	1.10	0.035	0.04	0.043
H	1.90	2.0	2.10	0.75	0.08	0.83
I	0.50	0.6	0.70	0.020	0.024	0.028
J	1.70	1.8	1.90	0.067	0.07	0.075

Electrical Connections		
Connection		Terminals
Port 1	Single-ended Input	2
Port 2	Single-ended Output	5
	Ground	All others
Single-ended Operation Only		
Dot indicates Pin 1		

Materials	
Solder Pad Plating	0.3 to 1.0 μm Gold over 1.27 to 8.89 μm Nickel
Lid Plating	2.0 to 3.0 μm Nickel
Body	Al_2O_3 Ceramic

TOP VIEW

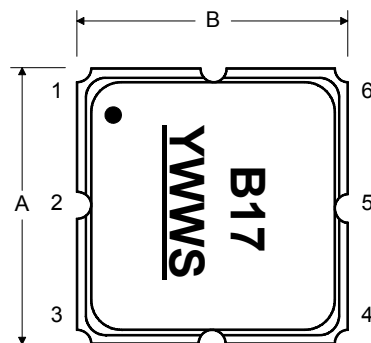

BOTTOM VIEW

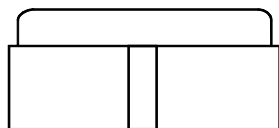
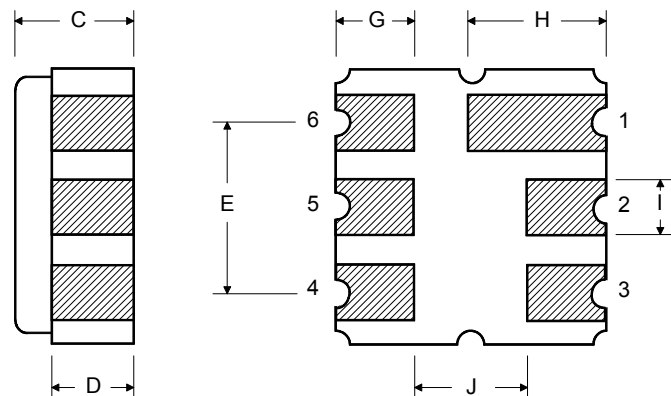

Tape and Reel Specifications

Tape and Reel Standard per ANSI/EIA-481

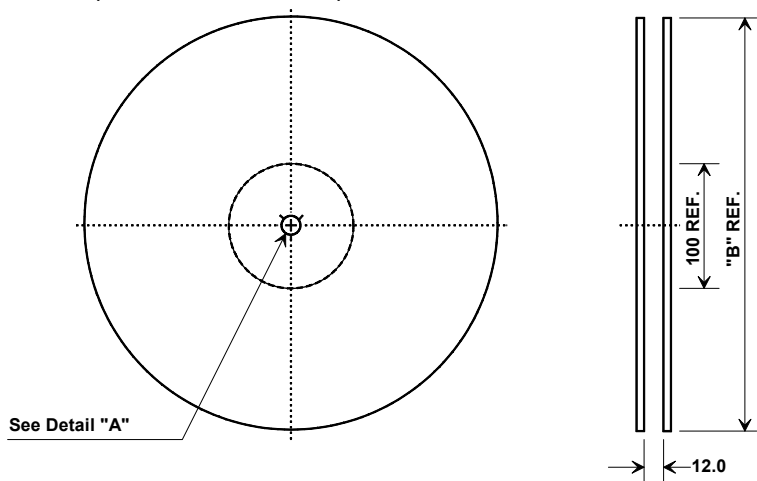

"B "		Quantity Per Reel
Inches	millimeters	
7	178	500
13	330	3000

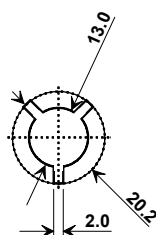

COMPONENT ORIENTATION and DIMENSIONS

Carrier Tape Dimensions	
Ao	4.25 mm
Bo	4.25 mm
Ko	1.30 mm
Pitch	8.0 mm
W	12.0 mm

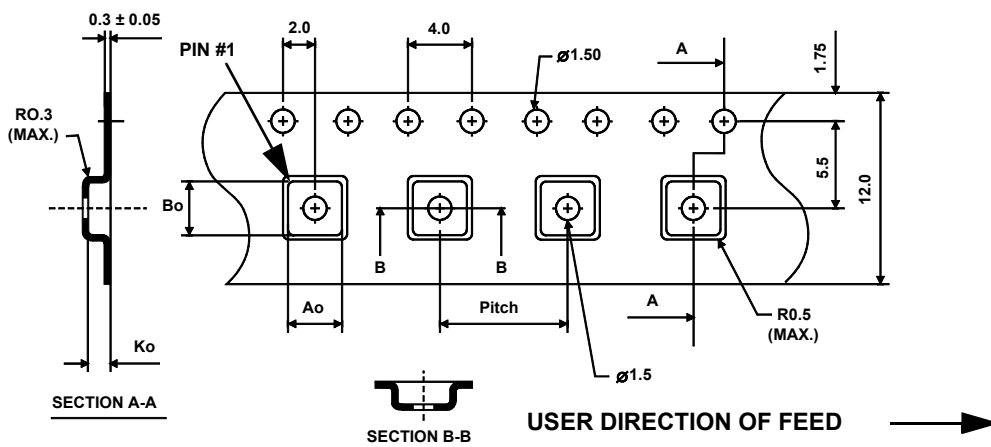

Recommended Reflow Profile

1. Preheating shall be fixed at 150~180°C for 60~90 seconds.
2. Ascending time to preheating temperature 150°C shall be 30 seconds min.
3. Heating shall be fixed at 220°C for 50~80 seconds and at 260°C +0/-5°C peak (10 seconds).
4. Time: 5 times maximum.

