

## Weidmüller Interface Units

From the point of view of saving costs when producing switchgear cabinets, interface units offer an alternative concept to the wiring of single conductors. The main task of interface units is the trouble-free conversion of standardised plug-in connector systems to single conductor wiring or to another connection system.

Interface units are composed of the following components:

- extrusion profile for insertion of the card
- end plate for mounting rail installation
- mounting feet for installing onto standardised TS 32 and TS 35 mounting rails
- printed-circuit board with connection and indicating elements, preassembled DIN plug-in connectors and tag carriers for marking electrical equipment

The plug-in connectors used in the interface units are divided into the following groups:

- ribbon cable plug-in connectors according to IEC 603-1/DIN 41 651.
- subminiature connectors (SUB-D) according to IEC 807-2/DIN 41 652.
- connectors for printed circuits according to IEC 603/DIN 41 612 and 41 617.
- ELCO connectors for EXi applications in the processing industry

Pre-assembled cables with corresponding plug-in connector systems are used for connections between higher-level controls and interface units.

This is where the user has the largest potential for saving costs. The use of system cables with large numbers of poles considerably reduces wiring costs, consisting of wage and material costs. The conversion to single conductor wiring is made directly at the interface unit. The user is offered screw / tension clamp or plug-in connections to connect actuators and sensors. Optional additional functions such as status indicators, signal separation, fuses or shielding can be integrated. Marking systems ease the task of assigning signals to the respective elements.

Advantages of interface units:

- space-saving mounting by using two and three tier card connection elements.
- cost saving, unilateral conventional single conductor wiring.
- more protection against faulty wiring.
- additional options:  
Status indication by integrating LEDs on the interface unit.
- faster troubleshooting thanks to additional test and measurement devices.
- simplified commissioning and documentation.

Using interface units allows trend-setting rationalisation concepts to be carried out in switchgear cabinet manufacturing. Not only do they reduce the share of pure labour costs of wiring tasks, but also the share of costs for materials, such as cable and conductors, cable ducts, terminal blocks and terminal boxes.

Customer-specific wiring concepts are efficiently put into practice by the use of special interface units.

### Interface unit RSF for ribbon cables in accordance with IEC 603-1/DIN 41 651



Passive interface for 10...64 signals to adapt pre-assembled ribbon cable plug-in connectors to a screw or tension clamp connection in accordance with IEC 603-1/ DIN 41 651.

Combined with an LED status indicator, the modules provide rapid information on the switching status of incoming and outgoing signals within a control unit.

### Interface unit RSSD for subminiature plug-in connectors (SUB-D) in accordance with IEC 807-2/DIN 41 652



Passives interface for 9 ... 50 signals for conversion of preassembled cables with SUB-D connectors in accordance with IEC 807-2/DIN 41 652 to screw or tension clamp connection technology. The modules are delivered with either socket strips (female) or pin headers (male). A spacer block between the plug-in connectors and the card takes up the mechanical forces created by the connected cable. RSSD interface units are optionally available with a frame terminal for connecting shielded conductors. An additional potential connection eases testing and measuring during commissioning and maintenance tasks.

### RS VERT interface units as potential distributors

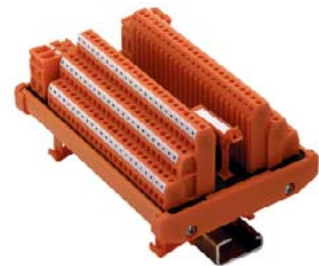

Passive interface for distributing DC supply voltages. The interface units are available in three versions for distribution to 8, 16 and 72 connection elements for the positive and negative potentials.

- 8- 16-channel distributors in 45-mm, 72-channel distributors in 100-mm widths.
- power supply via two connection elements respectively for positive and negative potentials.
- Mount on to TS 32/35 mounting rails.

RS VERT potential distributors can be installed in small distributor boxes, and provide a clearly arranged potential distribution.

## Interface Units

### Interface units RSELCO for hermaphroditic plugs

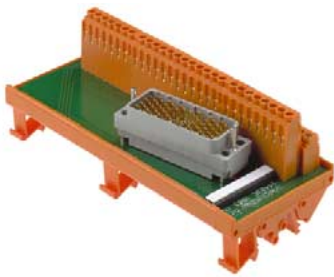

Passive interface to convert hermaphroditic ELCO multipole connectors to input and output with screw connections.

Hermaphroditic contacts are achieved by a fork that is identical at both ends of the connection.

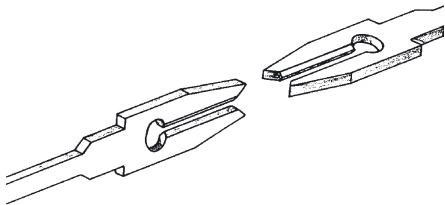

The advantage of this type of connector is essentially the large contact area (making it suitable for low currents), the long operational lifetime, and the high resistance to shock and vibration.

An adjustment screw eases insertion, and ensures a reliable interlock of the pair of connectors.

All types are available as "left" and "right" versions.

All interface units are supplied individually marked with consecutive numbering, and can be fitted with 6-digit group markers. The universal foot allows all modules to be assembled onto TS 32, TS 35x7.5 and TS 35x15 mounting rails in accordance with the European standards EN 50 035 and EN 50 022.

### Interface unit RSDIN for plug-in connectors according to IEC 603/ DIN 41 612 and 41 617



Passive interface for adapting the female and male connector blocks in the design versions B, C, D and F with screw connections.

### Card holders for adapting rack cards in Euro format to plug-in connectors according to IEC603 / DIN 41612 and DIN 41617



Card holders enable the fast conversion of electronic components.

As with interface units, IEC 803/ DIN 41612/617 plug-in connectors on card holders are converted to screw /push-on connection technology.

The card holders are constructed as follows:

- card with PCB terminals and standardised plug-in connector for mounting an electronic module in 19" Euro format: 160x100 or 233x160 mm
- retention pillars and interlock for securing the card
- mounting plate and mounting foot for mounting directly or onto mounting rails.

The SKH2 card holder range is distinguished by its design and functionality

- 19" Euro card completely protected at the rear against foreign bodies.
- eject mechanism guarantees one-hand operation
- electronic module can be secured to the front, similar to the 19" rack

Card holders are used in industrial applications where individual 19" modules need to be quickly adapted, but the costs for 19" card racks are too high. Card racks are voluminous, and are generally only accessible from the rear. As a rule, they do not have screw / tension clamp connections for external wiring, which makes them difficult to handle for wiring purposes.

Card holders are considered in the first place

- if only a few cards are to be installed and connected
- if the conductor card is placed decentralized, i.e., favourable for wiring
- if older installations are to be extended with additional electronic modules

Other typical applications are test equipment and testing modules in production processes and laboratories.

This is where a fast exchange of the card and an optimum handling of the connection level are of a premium.

### Standards

The following standards are fulfilled:

EN 50178 Fitting heavy voltage installations with electronic equipment

DIN VDE 0109 Coordination of insulation in low voltage installations including clearance and creepage distances for assembled cards.

# Interface Units

## For ribbon cable connections according to IEC 603-1/DIN 41 651

- With fixing foot for TS 32, TS 35 x 7.5 and TS 35 x 15
- Male connector block with interlock for female connector block with strain relief according to DIN 41 651/ Parts1 and 2
- RSF on FS 45 profile is equipped with an additional potential connection for test purposes
- Optionally available with tension clamp or Screw connection

### RSF ... Z

Interface units for ribbon cables  
Tension clamp

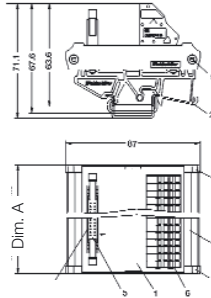

### RSF

Interface units for ribbon cables on RS 45-profile  
Screw connection

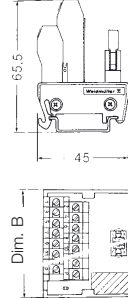
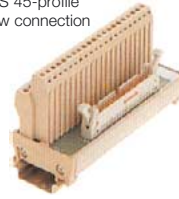

### RSF

Without status indicator  
Screw connection

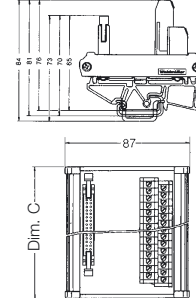

### RSF

Without status indicator  
Screw connection

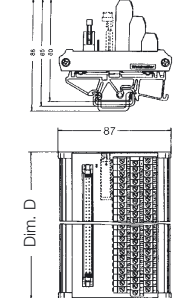

#### Ordering data/dimensions (mm)

Poles	Dim. A	Dim. B	Dim. C	Dim. D
10	50	49	50	40
14	50	56	50	45
16	55	64	55	50
20	65	71	65	50
26	80	86	80	55
34	110	106	110	70
40	115	121	115	80
50	145	151	145	95
60	180	180	180	115
64	180	186	180	120

On TS 35 x 7.5

#### Dimensions

Insulation stripping length  
Overall width

#### Connection cross-section

max. terminal range in mm<sup>2</sup>  
Screw connection, solid H07V-U  
Screw connection, flexible H07V-U  
Screw connection, flexible H07V-U with AEH/DIN 46228/1/4

Conductor cross-section  
Conversion connection level/plug connection  
Housing/socket type  
Connection type

#### Rated data

Rated voltage  
Rated current per contact  
Rated cross-section  
Test voltage  
Ambient temperature  
Storage temperature

#### Insulation coordination according to EN 50 178

Overvoltage category  
Pollution degree

#### Accessories

Mounting rail  
End bracket

Tag carrier type  
Insert tag (unprinted)  
Protective strip, transparent

Type	Cat. No.	Type	Cat. No.	Type	Cat. No.	Type	Cat. No.
RSF 10 Z	8537190000	RSF 10	8155610000	RSF 10	0224961001	RSF 10	8012850000
RSF 14 Z	8537200000	RSF 14	8258980000	RSF 14	0225061001	RSF 14	8012860000
RSF 16 Z	8537210000	RSF 16	8265540000	RSF 16	0225161001	RSF 16	8012870000
RSF 20 Z	8537110000	RSF 20	8155600000	RSF 20	0224261001	RSF 20	8012910000
RSF 26 Z	8537180000	RSF 26	8213470000	RSF 26	0224861001	RSF 26	8012920000
RSF 34 Z	8537130000	RSF 34	8155590000	RSF 34	0224361001	RSF 34	8012930000
RSF 40 Z	8537140000	RSF 40	8155580000	RSF 40	0224461001	RSF 40	8012940000
RSF 50 Z	8537150000	RSF 50	8155570000	RSF 50	0224561001	RSF 50	8012950000
RSF 60 Z	8537160000	RSF 60	8259000000	RSF 60	0224661001	RSF 60	8012960000
RSF 64 Z	8537170000	RSF 64	8155550000	RSF 64	0224761001	RSF 64	8012970000

Intended for tag carrier  
Type SchT 7/2  
Cat. No. 1359360000

7.5 mm  
See table, dim. A  
7 mm  
See table, dim. B  
7 mm  
See table, dim. C  
7 mm  
See table, dim. D

AWG 26...16  
1: 1  
RS 80 profile/TS 32 and TS35  
Tension clamp  
LM2NZF terminal  
Plug connection  
Ribbon connector i.a.w. to DIN 41 651 / IEC 603-1

60 V~, 75 V~)  
1 A  
1.5 mm<sup>2</sup>  
1 kV~eff  
0 °C...+55 °C  
-40 °C...+70 °C

III  
2

Type	Cat. No.	Qty.	Type	Cat. No.	Qty.	Type	Cat. No.	Qty.	Type	Cat. No.	Qty.
TS 32	0122800000	-	TS 32	0122800000	-	TS 32	0122800000	-	TS 32	0122800000	-
TS 35 x 7.5	0383400000	-	TS 35 x 7.5	0383400000	-	TS 35 x 7.5	0383400000	-	TS 35 x 7.5	0383400000	-
TS 35 x 15	0498000000	-	TS 35 x 15	0498000000	-	TS 35 x 15	0498000000	-	TS 35 x 15	0498000000	-
EWK 2	0199360000	50	EWK 2	0199360000	50	EWK 2	0199360000	50	EWK 2	0199360000	50
EW 35	0383560000	50	EW 35	0383560000	50	EW 35	0383560000	50	EW 35	0383560000	50

SchT 7/2 1359360000 20  
ESO 7 0515200000 10  
STR 7 0515300000 10

1) The additional clause in EN 50 178 and in IEC 807-2/DIN 41 652 are to be observed when used in industrial installations.



# Interface Units

## For sub miniature plug-in connectors according to IEC 807-2/DIN 41 652

- With fixing foot for TS 32, TS 35 x 7.5 and TS 35 x 15
- Male and female connectors with screw/locking system UNC 4/40
- RSF on FS 45 profile is equipped with an additional potential connection for test purposes
- Optionally available with tension clamp or screw connection

### RSSD

Male and female connector  
Tension clamp

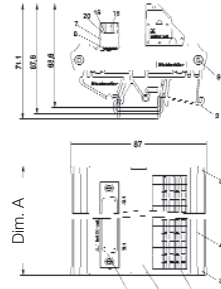

### RSSD

Interface units  
for male and female connectors on RS 45-profile  
Screw connection

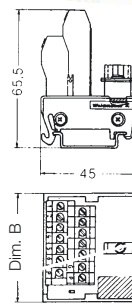

### RSSD S

Male connector  
**without** status indicator  
Screw connection

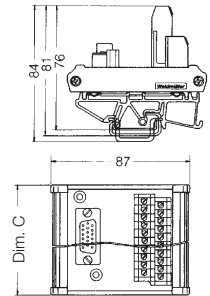

### RSSD B

Female connector  
**without** status indicator  
Screw connection

Ordering data/Dimensions (mm)			
Poles	Dim. A	Dim. B	Dim. C
9	45	50	45
15	60	61	60
25	80	86	80
37	110	116	110
50	145	154	145

On TS 35 x 7.5

Type	Cat. No.
<b>Male connector</b>	
RS SD 9 S	8537260000
RS SD 15 S	8537390000
RS SD 25 S	8537370000
RS SD 37 S	8537240000
RS SD 50 S	8537350000
<b>Female connector</b>	
RS SD 9 B	8537320000
RS SD 15 B	8537400000
RS SD 25 B	8537380000
RS SD 37 B	8537250000
RS SD 50 B	8537360000

Type	Cat. No.
<b>Male connector</b>	
RSSD 9 S	8259010000
RSSD 15 S	8233350000
RSSD 25 S	8155650000
RSSD 37 S	8155660000
RSSD 50 S	8155670000
<b>Female connector</b>	
RSSD 9 B	8216480000
RSSD 15 B	8209730000
RSSD 25 B	8155620000
RSSD 37 B	8155630000
RSSD 50 B	8155640000

Type	Cat. No.
<b>Male connector</b>	
RSSD 9 S	8003901001
RSSD 15 S	8005201001
RSSD 25 S	8005181001
RSSD 37 S	8003881001
RSSD 50 S	8005161001

Type	Cat. No.
<b>Female connector</b>	
RSSD 9 B	8003911001
RSSD 15 B	8005211001
RSSD 25 B	8005191001
RSSD 37 B	8003891001
RSSD 50 B	8005171001

### Dimensions

Insulation stripping length

Overall width

### Connection cross-section

Max. terminal range in mm<sup>2</sup>

Screw connection, solid H07V-U

Screw connection, flexible H07V-U

Screw connection, flexible H07V-U with AEH/DIN 46228/1/4

Conductor cross-section

Conversion connection level/plug connection

Housing/socket type

Connection type	
- Process side	RS 80 profile/TS 32 and TS 35
- Type	Tension clamp connection
- Control side	LM2NZF terminal
- Type	Plug connection
- Type	Sub-D i.a.w. DIN 41 652
- Type	IEC 807-2

### With UNC 4/40 interlock

7.5 mm

See table, dim. A

0.5...2.5 mm<sup>2</sup>

0.5...1.5 mm<sup>2</sup>

0.25...1.5 mm<sup>2</sup>

AWG 26...16

1 : 1

RS 80 profile/TS 32 and TS 35

Tension clamp connection

LM2NZF terminal

Plug connection

Sub-D i.a.w. DIN 41 652

IEC 807-2

### With UNC 4/40 interlock

7 mm

See table, dim. B

0.5...2.5 mm<sup>2</sup>

0.5...1.5 mm<sup>2</sup>

AWG 26...16

1 : 1

RS 45 profile/TS 35

Screw connection

LPK 2 H terminal

Plug connection

Sub-D i.a.w. DIN 41 652

IEC 807-2

### With UNC 4/40 interlock

7 mm

See table, dim. C

0.5...4 mm<sup>2</sup>

0.5...4 mm<sup>2</sup>

AWG 26...14

1 : 1

RS 80 profile/TS 32 and 35

Screw connection

LP2N terminal

Plug connection

Sub-D i.a.w. DIN 41 652

IEC 807-2

### With UNC 4/40 interlock

7 mm

See table, dim. C

0.5...4 mm<sup>2</sup>

0.5...4 mm<sup>2</sup>

AWG 26...14

1 : 1

RS 80 profile/TS 32 and 35

Screw connection

LP2N terminal

Plug connection

Sub-D i.a.w. DIN 41 652

IEC 807-2

### Rated data

Rated voltage

Rated current per contact

Rated cross-section

Test voltage

Ambient temperature

Storage temperature

### Insulation coordination according to EN 50 178

Overvoltage category

Pollution degree

### Accessories

Mounting rail

End bracket

for TS 32

for TS 35

Screw lock

Tag carrier type

Insert tag (unprinted)

Protective strip, transparent

125 V~, 150 V<sup>-1</sup>)

1.5 A

1.5 mm<sup>2</sup>

1 kV~eff

0 °C...+55 °C

-40 °C...+70 °C

III

2

Type	Cat. No.	Qty.
TS 32	0122800000	-
TS 35 x 7.5	0383400000	-
TS 35 x 15	0498000000	-
EWK 2	0199360000	50
EW 35	0383560000	50
SUB-D4/40	1155000000	2

125 V~, 150 V<sup>-1</sup>)

1.5 A

1.5 mm<sup>2</sup>

1 kV~eff

0 °C...+55 °C

-40 °C...+70 °C

III

2

Type	Cat. No.	Qty.
TS 35 x 7.5	0383400000	-
TS 35 x 15	0498000000	-
EWK 2	0199360000	50
EW 35	0383560000	50
SUB-D4/40	1155000000	2

125 V~, 150 V<sup>-1</sup>)

1.5 A (max. 45 °C amb. temp.)

2.5 mm<sup>2</sup>

1 kV~eff

0 °C...+55 °C

-40 °C...+70 °C

III

2

Type	Cat. No.	Qty.
TS 32	0122800000	-
TS 35 x 7.5	0383400000	-
TS 35 x 15	0498000000	-
EWK 2	0199360000	50
EW 35	0383560000	50
SUB-D 4/40	1155000000	2

125 V~, 150 V<sup>-1</sup>)

1.5 A (max. 45 °C amb. temp.)

2.5 mm<sup>2</sup>

1 kV~eff

0 °C...+55 °C

-40 °C...+70 °C

III

2

Type	Cat. No.	Qty.
TS 32	0122800000	-
TS 35 x 7.5	0383400000	-
TS 35 x 15	0498000000	-
EWK 2	0199360000	50
EW 35	0383560000	50
SUB-D 4/40	1155000000	2
SchT 7/2	1359360000	20
ESO 7	0515200000	10
STR 7	0515300000	10

1) The additional clause in EN 50 178 and in IEC 807-2/DIN 41 652 are to be observed when used in industrial installations

# Interface Units

## For sub miniature plug-in connectors according to IEC 807-2/DIN 41 652

- With fixing foot for TS 32, TS 35 x 7.5 and TS 35 x 15
- Male and female connectors with screw/locking system UNC 4/40
- 3-tier connection elements reduce module size
- Ground connection for shielded cables
- Test connection for measurement purposes

**RSSD S**  
Male connector  
without status indicator  
Screw connection

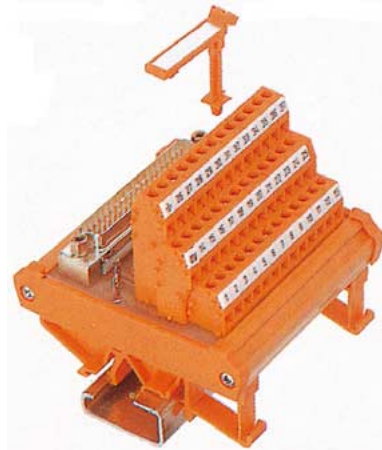

**RSSD B**  
Female connector  
without status indicator  
Screw connection

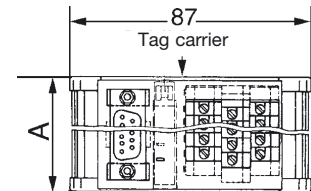
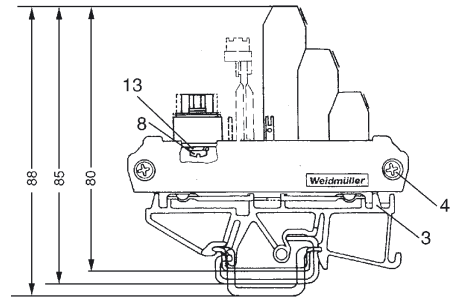

Ordering data/dimensions (mm)	
Poles	Dim. A
9	40
15	45
25	60
37	80
50	100

Type	Cat. No.	Type	Cat. No.
Male connector		Female connector	
RSSD 9 S	8019930000	RSSD 9 B	8019880000
RSSD 15 S	8019940000	RSSD 15 B	8019890000
RSSD 25 S	8019950000	RSSD 25 B	8019900000
RSSD 37 S	8019960000	RSSD 37 B	8019910000
RSSD 50 S	8019970000	RSSD 50 B	8019920000

designed for tag carrier SchT 7/2  
Cat. No. 1359360000

designed for tag carrier SchT 7/2  
Cat. No. 1359360000

Lock to UNC 4/40

Lock to UNC 4/40

Dimensions	
Insulation stripping length	7 mm
Overall width	See table, dim. A
Connection cross-section	
Screw connection, solid	0.5...2.5 mm <sup>2</sup>
Screw connection, flexible	0.5...1.5 mm <sup>2</sup>
Conductor cross-section	AWG 26...16
Conversion connection level/plug connection	1 : 1
Housing/socket type	RS 80 profile/TS 32 and 35
Connection type	Screw connection
- Process side	LPK 3 terminal
- Type	Plug connection
- Control side	Sub-D i.a.w. DIN 41 652
- Type	IEC 807-2

7 mm	7 mm
See table, dim. A	See table, dim. A
0.5...2.5 mm <sup>2</sup>	0.5...2.5 mm <sup>2</sup>
0.5...1.5 mm <sup>2</sup>	0.5...1.5 mm <sup>2</sup>
AWG 26...16	AWG 26...16
1 : 1	1 : 1
RS 80 profile/TS 32 and 35	RS 80 profile/TS 32 and 35
Screw connection	Screw connection
LPK 3 terminal	LPK 3 terminal
Plug connection	Plug connection
Sub-D i.a.w. DIN 41 652	Sub-D i.a.w. DIN 41 652
IEC 807-2	IEC 807-2

Rated data	
Rated voltage	125 V~, 150 V~ <sup>1)</sup>
Rated current per contact	1.5 A
Rated cross-section	1.5 mm <sup>2</sup>
Test voltage	1 kV~eff
Ambient temperature	0 °C...+55 °C
Storage temperature	-40 °C...+70 °C
Insulation coordination according to EN 50 178	
Overvoltage category	III
Pollution degree	2

125 V~, 150 V~ <sup>1)</sup>	125 V~, 150 V~ <sup>1)</sup>
1.5 A	1.5 A
1.5 mm <sup>2</sup>	1.5 mm <sup>2</sup>
1 kV~eff	1 kV~eff
0 °C...+55 °C	0 °C...+55 °C
-40 °C...+70 °C	-40 °C...+70 °C
III	III
2	2

Accessories	
Mounting rail	
End bracket	for TS 32
	for TS 35
Screw lock	
Tag carrier type	
Insert tag (unprinted)	
Protective strip, transparent	

Type	Cat. No.	Qty.	Type	Cat. No.	Qty.
TS 32	0122800000	-	TS 32	0122800000	-
TS 35 x 7.5	0383400000	-	TS 35 x 7.5	0383400000	-
TS 35 x 15	0498000000	-	TS 35 x 15	0498000000	-
EWK 2	0199360000	50	EWK 2	0199360000	50
EW 35	0383560000	50	EW 35	0383560000	50
SUB-D 4/40	1155000000	2	SUB-D 4/40	1155000000	2
SchT 7/2	1359360000	20	SchT 7/2	1359360000	20
ESO 7	0515200000	10	ESO 7	0515200000	10
STR 7	0515300000	10	STR 7	0515300000	10

<sup>1)</sup> The additional clause in EN 50 178 and in IEC 807-2/DIN 41 652 are to be observed when used in industrial installations

# Interface Units

## Distributors for 8, 16 and 72 positive and negative potentials

- Adapts 2 supply connections to 8/16 or 72 potential distribution terminals
- Potential distributor designed as two- or three-tier connection element
- RS VERT8 and RS VERT16 offer clearly arranged potential distribution in tight spaces. They are designed for residual currents of 10 A.
- RS LPK3/144 VERT is designed for residual currents of 20A.

### RS VERT8 LPK2

### RS VERT16 LPK2

### RS LPK3/144 VERT

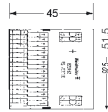
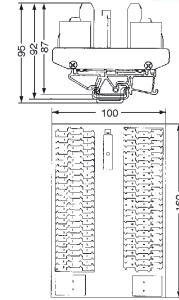
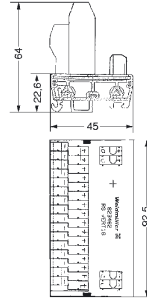
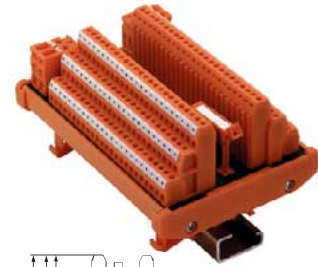

Ordering data/Dimensions (mm)	Type	Cat. No.	Type	Cat. No.	Type	Cat. No.
	RS VERT 8 LPK2	<b>8252010000</b>	RS VERT 16 LPK2	<b>8234620000</b>	RS LPK3/144 VERT	<b>8199510000</b>
<b>Dimensions</b>						
Insulation stripping length	7 mm		7 mm		7 mm	
Overall width	51.5 mm		92.5 mm		160 mm	
<b>Connection cross-section</b>						
Screw connection, solid core	0.5...2.5 mm <sup>2</sup>		0.5...2.5 mm <sup>2</sup>		0.5...2.5 mm <sup>2</sup>	
Screw connection, flexible	0.5..0.1.5 mm <sup>2</sup>		0.5..0.1.5 mm <sup>2</sup>		0.5..0.1.5 mm <sup>2</sup>	
Conductor cross-section	AWG 26...16		AWG 26...16		AWG 26...16	
Housing/socket type	RS 45 profile/TS 35		RS 45 profile/TS 35		RS 100 profile/TS 32 and 35	
<b>Rated data</b>						
Rated voltage	24 V0		24 V0		250 V-	
Max. residual current supply	10 A		10 A		20 A	
Potential distribution "plus"/"minus"	8		16		72	
Rated cross-section	1.5 mm <sup>2</sup>		1.5 mm <sup>2</sup>		1.5 mm <sup>2</sup>	
Max. output current per terminal	5 A		5 A		10 A	
Ambient temperature	0 °C...+55 °C		0 °C...+55 °C		0 °C...+55 °C	
Storage temperature	-40 °C...+70 °C		-40 °C...+70 °C		-40 °C...+70 °C	
<b>Insulation coordination according to EN 50 178</b>						
Overvoltage category	III		III		III	
Pollution degree	2		2		2	
<b>Accessories</b>						
Mounting rail						
	TS 35 x 7.5	<b>0383400000</b> -	TS 35 x 7.5	<b>0383400000</b> -	TS 32	<b>0122800000</b> -
	TS 35 x 15	<b>0498000000</b> -	TS 35 x 15	<b>0498000000</b> -	TS 35 x 7.5	<b>0383400000</b> -
End bracket	for TS 32		EW 35	<b>0383560000</b> -	TS 35 x 15	<b>0498000000</b> -
	for TS 35				EWK 2	<b>0199360000</b> -
					EW 35	<b>0383560000</b> -
Tag carrier type						
Insert tag (unprinted)					SchT 7/2	<b>1359360000</b> -
Protective strip, transparent					ESO 7	<b>0515200000</b> -
					STR 7	<b>0515300000</b> -

# Interface Units

For hermaphroditic plugs

## RSELCO

Short, 56-pole

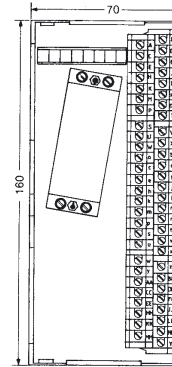
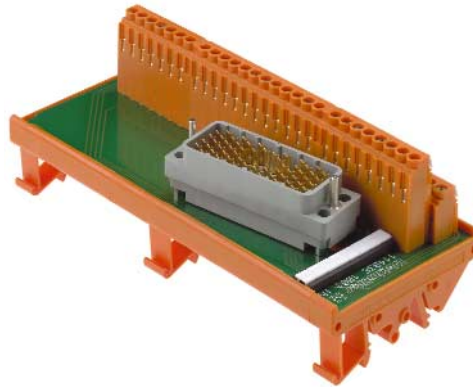
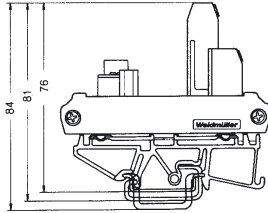

Pin assignment:  
LP2N screw terminal

ELCO plug

1	A
2	B
•	•
•	•
19	W
20	X
Y	Y
21	a
22	b
•	•
•	•
42	z
43	AA
44	BB
•	•
•	•
32	n
33	p
34	r
•	•
•	•
42	z
43	AA
44	BB
•	•
•	•
53	MM
54	NN
Y	Y

Ordering data		Type	Cat. No.
		RSELCO, left	<b>1149361001</b>
		RSELCO, right	<b>1149461001</b>
Dimensions			
Insulation stripping length		7 mm	
Overall width		160 mm	
Connection cross-section			
Screw connection, solid		0.5...4 mm <sup>2</sup>	
Screw connection, flexible		0.5...2.5 mm <sup>2</sup>	
Conductor cross-section		AWG 26...14	
Conversion connection level/plug connection		1 : 1	
Housing/socket type		RS 70 profile/TS 32 and 35	
Connection type		- Process side - Type - Control side - Type	Plug connection ELCO type 8016 Screw connection LP2N terminal
Rated data			
Rated voltage		125 V~	
Rated current per contact		1.5 A	
Rated cross-section		2.5 mm <sup>2</sup>	
Test voltage		1.5 kV~eff	
Ambient temperature		0 °C...+55 °C	
Storage temperature		-40 °C...+70 °C	
Insulation coordination according to EN 50 178			
Overvoltage category		III	
Pollution degree		2	
Accessories		Cat. No.	Cat. No.
Mounting rail		TS 32	<b>0122800000</b> -
		TS 35 x 7.5	<b>0383400000</b> -
		TS 35 x 15	<b>0498000000</b> -
End bracket		for TS 32	EWK 2 <b>0199360000</b> 50
		for TS 35	EW 35 <b>0383560000</b> 50
Screw lock			
Insert tag (unprinted)		DEK5	page 312



# Interface Units

## Plug-in connectors designs in accordance with IEC 603/DIN 41612

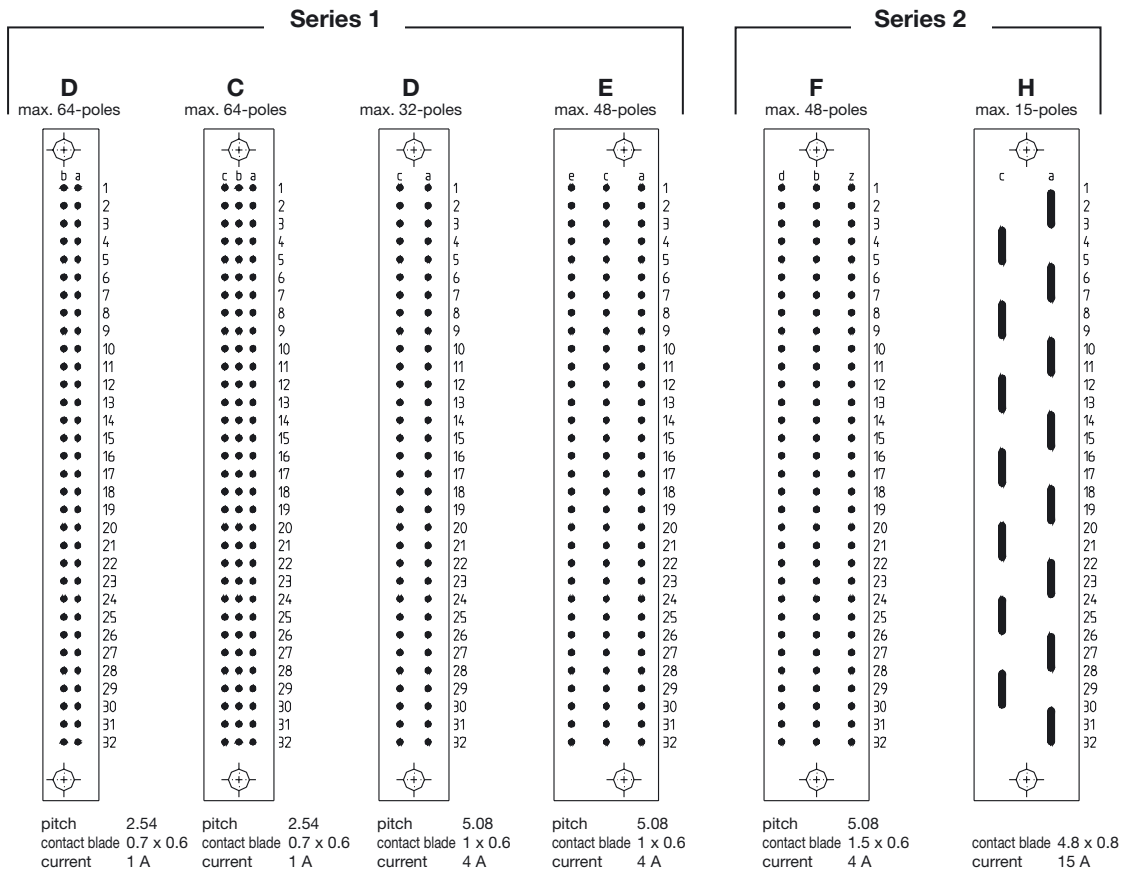

### Production series 1

Plug-in connectors from this production series are of conventional, high-pole design with low contact distances and a max. current carrying capacity of 1 A. In addition, there are versions commercially available on the market with up to 4 A contact currents in 5.08-mm grid with less poles (up to 48).

#### Design B

A 64-pole plug-in connector with row assignment a and b, and a contact current capacity of max. 1A. The rated voltage is defined in accordance with IEC 664/ EN 50178 as 125 V. A variant is a 32-pole version, where only the odd number poles are assembled.

#### Design C

An extension of design B; the addition of contact row c results in a 96-pole plug-in connector. An alternative design is type C 64, with which the outer rows c and a are assembled. A further reduction of the assembly results in the design C 32, with a vertical and horizontal contact grid dimension of 5.08 mm.

#### Design D

The dimensions and contact arrangement are identical with the C 32 design. The strengthened contacts can be loaded with up to 4 A.

#### Design E

An extension of the design D 32; the addition of the contact row e results in the 48-pole version of design E. With 4 A contact current in 5.08-mm grid dimension, this plug-in connector has been designed for heavy current loads. All even numbered poles are assembled in the contact rows e, c and a.

### Production series 2

This design differs from that of the design 1 with its differing grid dimensions of the rear connections of 5.08 mm and the contact rows of 3.81 mm on the mating face. The plastic housing has been designed to be higher at the back in order to increase the creepage distances (metal plate, PCB etc.). This results in an altered wiring level when compared with production series 1. The contacts have fundamentally been designed for a current carrying capacity of 4 A. These plug-in connectors are largely used for applications in power electronics. The fixing holes are arranged on the outside of the blocks in the middle.

#### Design F

48-pole, fully assembled contact rows d, b and z. Variants with part assembly of the rows z and b or z and d in 32-pole design are commercially available. The distinguishing feature of the designs with the contact variation z/d is their larger insulating distances.

#### Design H

These have the same dimensions as design F, and are assembled 11- or 15-pole high-current contacts. The plugging geometry differs from the other designs. The contacts have a current carrying capacity of max. 15 A.

# Interface Units

## For converting IEC 603/DIN 41 612 plug-in connectors

to LP connection elements for mounting rail or 19" rack installation

### RSDIN F 64 B

Female/male connector block

### RSDIN C 64

Female/male connector block

### RSDIN F 48 B

Female connector block

### RSDIN F 48 S

Male connector block

### RSDIN 19"

Female connector block

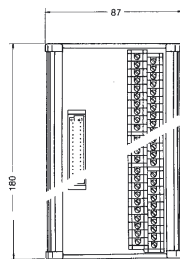
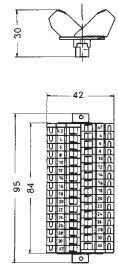
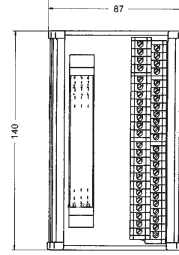
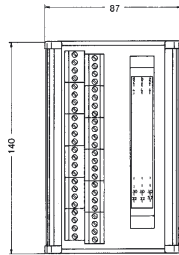
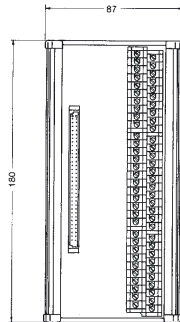
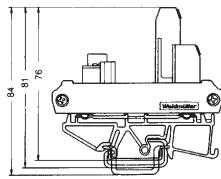
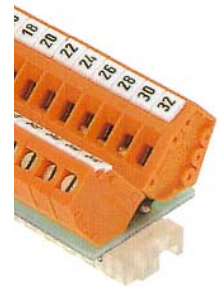
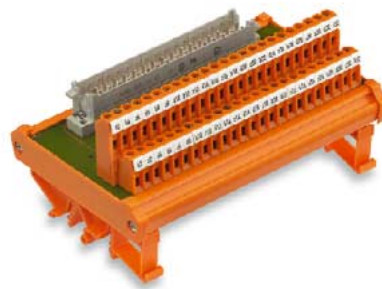
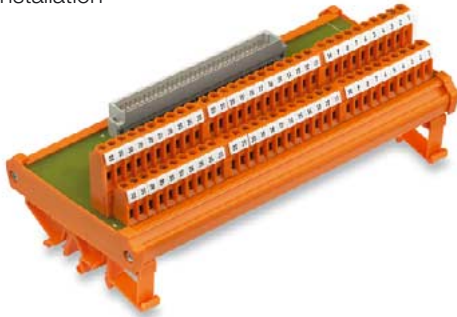

#### Ordering data

Type	RSDIN C 64 B*
Cat. No.	1127461001
Type	RSDIN B 64 S** RSDIN C 64 S**
Cat. No.	1178061001 1178161001

#### Technical data

Block	B 64	C 64
Plug-in connector	DIN 41 612	DIN 41 612
Assembly	a and b	a 1 and c 1
Connection type (screw connection)	LP2N	LP2N
<b>Dimensions</b>		
Insulation stripping length	7 mm	
Overall width	180 mm	
<b>Clampable conductors</b>		
Max. clamping range	0.13...4 mm <sup>2</sup>	
„e“ solid HO7V-U	0.5...4 mm <sup>2</sup>	
„f“ flexible HO7V-K	0.5...2.5 mm <sup>2</sup>	
„f“ with ferrules		
According to DIN 46228/1	0.5...2.5 mm <sup>2</sup>	
With plastic collar	0.5...2.5 mm <sup>2</sup>	
Conductor cross-section	AWG 26...14	
Plug gauge according to DIN/EN 50027	Size A3	

#### Rated data

Rated voltage	125 V~
Rated current per contact	1.5 A (max. 45 °C amb. temp.)
Rated cross-section	2.5 mm <sup>2</sup>
Test voltage	0.5 kV~eff
Test torque	0.4 Nm
Ambient temperature	0 °C...+55 °C
Storage temperature	-40 °C...+70 °C

#### Insulation coordination according to EN 50 178

Overvoltage category	III
Pollution degree	2

Type	RSDIN F 48 B
Cat. No.	1177960000

Block	F 48
Plug-in connector	DIN 41 612
Assembly	d 2, b 2 and z 2
Connection type (screw connection)	GSD 5
<b>Dimensions</b>	
Insulation stripping length	7 mm
Overall width	140 mm
<b>Clampable conductors</b>	
Max. clamping range	0.13...1.5 mm <sup>2</sup>
„e“ solid HO7V-U	0.5...1.5 mm <sup>2</sup>
„f“ flexible HO7V-K	0.5...1.5 mm <sup>2</sup>
„f“ with ferrules	
According to DIN 46228/1	0.5...1.5 mm <sup>2</sup>
With plastic collar	0.5...1.5 mm <sup>2</sup>
Conductor cross-section	AWG 26...16
Plug gauge according to DIN/EN 50027	Size A1

Rated voltage	125 V~
Rated current per contact	1.5 A (max. 45 °C amb. temp.)
Rated cross-section	1.5 mm <sup>2</sup>
Test voltage	0.5 kV~eff
Test torque	0.4 Nm
Ambient temperature	0 °C...+55 °C
Storage temperature	-40 °C...+70 °C

Overvoltage category	III
Pollution degree	2

\* Female connector block

Type	RSDIN F 48 S
Cat. No.	1178360000

Block	F 48
Plug-in connector	DIN 41 612
Assembly	d 2, b 2 and z 2
Connection type (screw connection)	LP2N
<b>Dimensions</b>	
Insulation stripping length	7 mm
Overall width	140 mm
<b>Clampable conductors</b>	
Max. clamping range	0.13...4 mm <sup>2</sup>
„e“ solid HO7V-U	0.5...4 mm <sup>2</sup>
„f“ flexible HO7V-K	0.5...2.5 mm <sup>2</sup>
„f“ with ferrules	
According to DIN 46228/1	0.5...2.5 mm <sup>2</sup>
With plastic collar	0.5...2.5 mm <sup>2</sup>
Conductor cross-section	AWG 26...14
Plug gauge according to DIN/EN 50027	Size A3

Rated voltage	125 V~
Rated current per contact	1.5 A (max. 45 °C amb. temp.)
Rated cross-section	1.5 mm <sup>2</sup>
Test voltage	0.5 kV~eff
Test torque	0.4 Nm
Ambient temperature	0 °C...+55 °C
Storage temperature	-40 °C...+70 °C

Overvoltage category	III
Pollution degree	2

\*\* Male connector block

Type	RSDIN 19"
Cat. No.	8019730000

Block	D 32
Plug-in connector	DIN 41 612
Assembly	a and c
Connection type (screw connection)	Screw connection
<b>Dimensions</b>	
Insulation stripping length	7 mm
Overall width	84 mm
<b>Clampable conductors</b>	
Max. clamping range	0.13...4 mm <sup>2</sup>
„e“ solid HO7V-U	0.5...4 mm <sup>2</sup>
„f“ flexible HO7V-K	0.5...2.5 mm <sup>2</sup>
„f“ with ferrules	
According to DIN 46228/1	0.5...2.5 mm <sup>2</sup>
With plastic collar	0.5...2.5 mm <sup>2</sup>
Conductor cross-section	AWG 26...14
Plug gauge according to DIN/EN 50027	Size A3

Rated voltage	125 V~
Rated current per contact	4 A (max. 45 °C amb. temp.)
Rated cross-section	1.5 mm <sup>2</sup>
Test voltage	2 kV~eff
Test torque	0.4 Nm
Ambient temperature	0 °C...+55 °C
Storage temperature	-40 °C...+70 °C

Overvoltage category	III
Pollution degree	2

# Card Holders

For inserting 19" rack cards in Euro format

- Convert IEC 603/DIN 41 612 and 41 617 plug-in connectors to LP connection elements
- Mechanical lever reliably releases and ejects card
- 19" inserts secured from the front
- Protective cover on rear side of card
- Mount direct in switchgear cabinet or on TS 35 mounting rail

**SKH2 31**  
**SKH2B 64**

**SKH2C 64 (a/c)**  
**SKH2B 32**

**SKH2E 48**  
**SKH2F 32 (z/b)**

**SKH2F 32 (z/d)**  
**SKH2F 48**

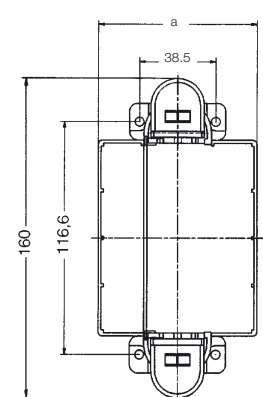
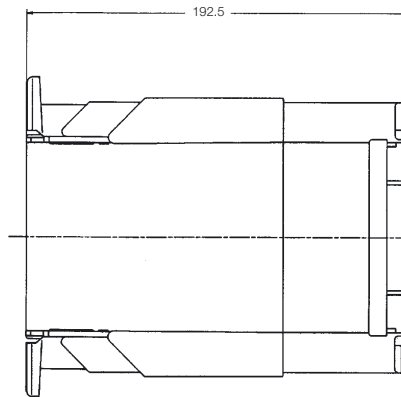
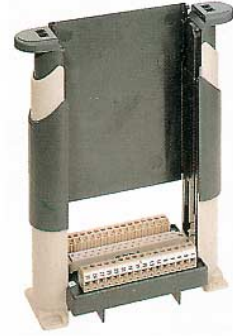

Ordering data	SKH2 31 SKH2B 64		SKH2C 64 (a/c) SKH2D 32		SKH2E 48 SKH2F 32 (z/b)		SKH2F 32 (z/d) SKH2F 48	
Cat. No.	<b>8174800000</b>	<b>8174810000</b>	<b>8174820000</b>	<b>8174830000</b>	<b>8174840000</b>	<b>8174850000</b>	<b>8174860000</b>	<b>8174880000</b>
<b>Technical data</b>	<b>31-pole B 64</b>		<b>C 64 D 32</b>		<b>E 48 F 32</b>		<b>F 32 F 48</b>	
Female connector block	DIN 41,617		DIN 41 612		DIN 41 612		DIN 41 612	
Plug-in connector	Screws		Screws		Screws		Screws	
Connection type	Screws		Screws		Screws		Screws	
Mechanical characteristics	Screws		Screws		Screws		Screws	
<b>Dimensions</b>	Max. permissible weight on card = 0.55 kg.							
Insulation stripping length	7 mm	7 mm	7 mm	7 mm	7 mm	7 mm	7 mm	7 mm
Terminal screw	M 2.5	M 2.5	M 2.5	M 2.5	M 2.5	M 2.5	M 2.5	M 2.5
Mounting width a	60.7 mm	80.7 mm	80.7 mm	55.0 mm	70.7 mm	80.7 mm	80.7 mm	80.7 mm
<b>Clampable conductors</b>								
Max. clamping range	0.13...2.5 mm <sup>2</sup>		0.13...2.5 mm <sup>2</sup>		0.13...2.5 mm <sup>2</sup>		0.13...2.5 mm <sup>2</sup>	
„e“ solid HO7V-U	0.5...2.5 mm <sup>2</sup>		0.5...2.5 mm <sup>2</sup>		0.5...2.5 mm <sup>2</sup>		0.5...2.5 mm <sup>2</sup>	
„f“ flexible HO7V-K	0.5...2.5 mm <sup>2</sup>		0.5...2.5 mm <sup>2</sup>		0.5...2.5 mm <sup>2</sup>		0.5...2.5 mm <sup>2</sup>	
„f“ with ferrules according to DIN 46228/1	0.5...1.5 mm <sup>2</sup>		0.5...1.5 mm <sup>2</sup>		0.5...1.5 mm <sup>2</sup>		0.5...1.5 mm <sup>2</sup>	
With plastic collar	0.5...1.5 mm <sup>2</sup>		0.5...1.5 mm <sup>2</sup>		0.5...1.5 mm <sup>2</sup>		0.5...1.5 mm <sup>2</sup>	
Conductor cross-section	AWG 26...14		AWG 26...14		AWG 26...14		AWG 26...14	
Plug gauge according to DIN/EN 50027	A1		A1		A1		A1	
Conversion connection terminal/plug-in connector	1 : 1		1 : 1		1 : 1		1 : 1	
<b>Rated data</b>								
Rated voltage	125 V~ 160 V~		160 V~ 250 V~		250 V~ 250 V~		250 V~ 250 V~	
Rated current	4 A 2 A		2 A 4 A		4 A 4 A		4 A 4 A	
Rated cross-section	1.5 mm <sup>2</sup> 1.5 mm <sup>2</sup>		1.5 mm <sup>2</sup> 1.5 mm <sup>2</sup>		1.5 mm <sup>2</sup> 1.5 mm <sup>2</sup>		1.5 mm <sup>2</sup> 1.5 mm <sup>2</sup>	
Test voltage	0.9 kV~eff 1.0 kV~eff		1.0 kV~eff 1.0 kV~eff		1.0 kV~eff 1.0 kV~eff		1.0 kV~eff 1.0 kV~eff	
Test torque	0.4 Nm 0.4 Nm		0.4 Nm 0.4 Nm		0.4 Nm 0.4 Nm		0.4 Nm 0.4 Nm	
Ambient temperature	0 °C...+55 °C		0 °C...+55 °C		0 °C...+55 °C		0 °C...+55 °C	
Storage temperature	-40 °C...+70 °C		-40 °C...+70 °C		-40 °C...+70 °C		-40 °C...+70 °C	
<b>Insulation coordination according to EN 50 178</b>								
Overvoltage category	III III		III III		III III		III III	
Pollution degree	2 2		2 2		2 2		2 2	
<b>Accessories</b>	Type Cat. No. Qty.		Type Cat. No. Qty.		Type Cat. No. Qty.		Type Cat. No. Qty.	
Assembly material for mounting on TS 35	SKH2/35 <b>8209340000</b> 1		SKH2/35 <b>8209340000</b> 1		SKH2/35 <b>8209340000</b> 1		SKH2/35 <b>8209340000</b> 1	
Mounting rail	TS 35 x 7.5 <b>0383400000</b> -		TS 35 x 7.5 <b>0383400000</b> -		TS 35 x 7.5 <b>0383400000</b> -		TS 35 x 7.5 <b>0383400000</b> -	
	TS 35 x 15 <b>0498000000</b> -		TS 35 x 15 <b>0498000000</b> -		TS 35 x 15 <b>0498000000</b> -		TS 35 x 15 <b>0498000000</b> -	

# Card Holders

- For inserting cards in Euro and double Euro format
- Convert IEC 603/DIN 41 612 and 41 617 plug-in connectors to LP connection elements

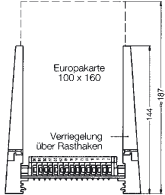

**SKH 31**  
**SKH 31 250 V**

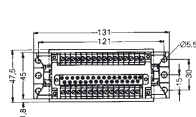

**SKHB 64**

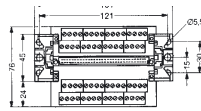

**SKHC 64**

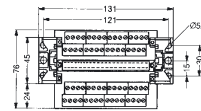

**SKHD 32**

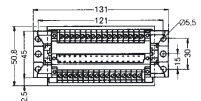

Ordering data	Type	Cat. No.	Qty.	Type	Cat. No.	Qty.	Type	Cat. No.	Qty.	Type	Cat. No.	Qty.	
	SKH 31	0586661001	1	SKHB 64	0577360000	1	SKHC 64	0178960000	1	SKHD 32	0586761001	1	
	SKH 31 250 V	0648661001	1				SKHC 64	0646660000	1				
							with 2 latch clips						
Technical data													
<b>Female connector block</b>	<b>31-pole</b> (i.a.w. DIN 41617)			<b>B 64</b> (i.a.w. DIN 41612)			<b>C 64</b> (i.a.w. DIN 41612)			<b>D 32</b> (i.a.w. DIN 41612)			
Assembly	Screws			a and b			a and c			a and c			
Connection type	Screws			Screws			Screws			Screws			
Dimensions													
Insulation stripping length	7 mm			7 mm			7 mm			7 mm			
Terminal screw	M 2.5			M 2.5			M 2.5			M 2.5			
Clampable conductors													
Max. clamping range	0.13...4 mm <sup>2</sup>			0.13...1.5 mm <sup>2</sup>			0.13...1.5 mm <sup>2</sup>			0.13...4 mm <sup>2</sup>			
„e“ solid HO7V-U	0.5...4 mm <sup>2</sup>			0.5...1.5 mm <sup>2</sup>			0.5...1.5 mm <sup>2</sup>			0.5...4 mm <sup>2</sup>			
„f“ flexible HO7V-U	0.5...2.5 mm <sup>2</sup>			0.5...1.5 mm <sup>2</sup>			0.5...1.5 mm <sup>2</sup>			0.5...2.5 mm <sup>2</sup>			
„f“ with ferrules													
According to DIN 46228/1	0.5...2.5 mm <sup>2</sup>			0.5...1.5 mm <sup>2</sup>			0.5...1.5 mm <sup>2</sup>			0.5...2.5 mm <sup>2</sup>			
With plastic collar	0.5...2.5 mm <sup>2</sup>			0.5...1.5 mm <sup>2</sup>			0.5...1.5 mm <sup>2</sup>			0.5...2.5 mm <sup>2</sup>			
Conductor cross-section	AWG 26...14			AWG 26...16			AWG 26...16			AWG 26...14			
Conversion connection level/	1 : 1			1 : 1			1 : 1			1 : 1			
Plug-in connector													
Plug gauge according to DIN/EN 50027 Size	A3			A1			A1			A3			
Rated data													
Rated voltage	125 V~ (0586660000) 250 V~ (0648660000)			125 V~			125 V~			250 V~			
Rated current	5 A			2 A			2 A			6 A			
Rated cross-section	2.5 mm <sup>2</sup>			1.5 mm <sup>2</sup>			1.5 mm <sup>2</sup>			2.5 mm <sup>2</sup>			
Test voltage	1.25 kV~eff (0586660000) 1.5 kV~eff (0648660000)			0.5 kV~eff			0.5 kV~eff			2.0 kV~eff			
Test torque	0.4 Nm			0.4 Nm			0.4 Nm			0.4 Nm			
Ambient temperature	0 °C...+55 °C			0 °C...+55 °C			0 °C...+55 °C			0 °C...+55 °C			
Storage temperature	-40 °C...+70 °C			-40 °C...+70 °C			-40 °C...+70 °C			-40 °C...+70 °C			
<b>Insulation coordination according to EN 50 178</b>													
Overvoltage category	III			III			III			III			
Pollution degree	2			2			2			2			
Accessories	Type	Cat. No.	Qty.	Type	Cat. No.	Qty.	Type	Cat. No.	Qty.	Type	Cat. No.	Qty.	
Support plate	HP	0137100000	20	HP	0137100000	20	HP	0137100000	20	HP	0137100000	20	
(To increase mechanical stability. Included in range of supply).													
Grip	white	ZG	0128000000	-	ZG	0128000000	-	ZG	0128000000	-	ZG	0128000000	-
	black	ZG	0128060000	-	ZG	0128060000	-	ZG	0128060000	-	ZG	0128060000	-
Mounting foot for TS 35 (metal)		FM 4	0687900000	40	FM 4	0687900000	40	FM 4	0687900000	40	FM 4	0687900000	40
Mounting bracket for mounting on TS 32		MB (M 3+M 5)	0503500000	100	MB (M 3+M 5)	0503500000	100	MB (M 3+M 5)	0503500000	100	MB (M 3+M 5)	0503500000	100
		MB (M 4+M 6)	0334900000	20	MB (M 4+M 6)	0334900000	20	MB (M 4+M 6)	0334900000	20	MB (M 4+M 6)	0334900000	20
Mounting plate		MP	2054280000	-	MP	2054280000	-	MP	2054280000	-	MP	2054280000	-
Mounting rail		TS 32	0122800000	-	TS 32	0122800000	-	TS 32	0122800000	-	TS 32	0122800000	-
		TS 35 x 7.5	0383400000	-	TS 35 x 7.5	0383400000	-	TS 35 x 7.5	0383400000	-	TS 35 x 7.5	0383400000	-
		TS 35 x 15	0498000000	-	TS 35 x 15	0498000000	-	TS 35 x 15	0498000000	-	TS 35 x 15	0498000000	-

# Card Holders

- For inserting cards in Euro and double Euro format
- Convert IEC 603/DIN 41 612 and 41 617 plug-in connectors to LP connection elements

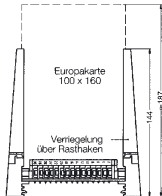

## SKHD 32

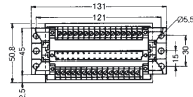

## SKHE 48

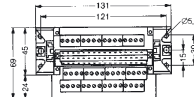

## SKHF 32

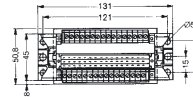

### Ordering data

Type	Cat. No.	Qty.
SKHD 32	<b>0107661001</b>	1
With mounting foot		
on <b>TS 35 horizontal</b>		
SKHD 32	<b>0106161001</b>	1
With mounting foot		
on <b>TS 35 vertical</b>		

### Technical data

#### Female connector block

Assembly	a and c
Connection type	Screws

### Dimensions

Insulation stripping length	7 mm
Terminal screw	M 2.5

### Clampable conductors

Max. clamping range	0.13...4 mm <sup>2</sup>
„e“ solid HO7V-U	0.5...4 mm <sup>2</sup>
„f“ flexible HO7V-U	0.5...2.5 mm <sup>2</sup>
„f“ with ferrules	
according to DIN 46228/1	0.5...2.5 mm <sup>2</sup>
With plastic collar	0.5...2.5 mm <sup>2</sup>
Conductor cross-section	26...14 mm <sup>2</sup>
Conversion connection level/	1 : 1
Plug-in connector	
Plug gauge according to DIN/EN 50027 Size	A3

### Rated data

Rated voltage	380 V~
Rated current	6 A
Rated cross-section	2.5 mm <sup>2</sup>
Test voltage	2.0 kV~eff
Test torque	0.4 Nm
Ambient temperature	0 °C...+55 °C
Storage temperature	-40 °C...+70 °C

### Insulation coordination according to EN 50 178

Overvoltage category	III
Pollution degree	2

### Accessories

Support plate (To increase mechanical stability. Included in range of supply).	HP	<b>0137100000</b>	20
Grip	ZG	<b>0128000000</b>	-
	ZG	<b>0128060000</b>	-
Mounting foot for TS 35 (metal)			
Mounting bracket for mounting on TS 32			
Mounting plate	MP	<b>2054280000</b>	-
Mounting rail	TS 32	<b>0122800000</b>	-
	TS 35 x 7,5	<b>0383400000</b>	-
	TS 35 x 15	<b>0498000000</b>	-

### Ordering data

Type	Cat. No.	Qty.
SKHD 32	<b>0107661001</b>	1
With mounting foot		
on <b>TS 35 horizontal</b>		
SKHD 32	<b>0106161001</b>	1
With mounting foot		
on <b>TS 35 vertical</b>		

#### D 32 (i.a.w. DIN 41612)

Assembly	a and c
Connection type	Screws

Insulation stripping length	7 mm
Terminal screw	M 2.5

Max. clamping range	0.13...4 mm <sup>2</sup>
„e“ solid HO7V-U	0.5...4 mm <sup>2</sup>
„f“ flexible HO7V-U	0.5...2.5 mm <sup>2</sup>
„f“ with ferrules	
according to DIN 46228/1	0.5...2.5 mm <sup>2</sup>
With plastic collar	0.5...2.5 mm <sup>2</sup>
Conductor cross-section	26...14 mm <sup>2</sup>
Conversion connection level/	1 : 1
Plug-in connector	
Plug gauge according to DIN/EN 50027 Size	A3

Rated voltage	380 V~
Rated current	6 A
Rated cross-section	2.5 mm <sup>2</sup>
Test voltage	2.0 kV~eff
Test torque	0.4 Nm
Ambient temperature	0 °C...+55 °C
Storage temperature	-40 °C...+70 °C

Overvoltage category	III
Pollution degree	2

Type	Cat. No.	Qty.
HP	<b>0137100000</b>	20

ZG	<b>0128000000</b>	-
ZG	<b>0128060000</b>	-

FM 4	<b>0687900000</b>	40
MB (M 3+M 5)	<b>0503500000</b>	100
MB (M 4+M 6)	<b>0334900000</b>	20
MP	<b>2054280000</b>	-

TS 32	<b>0122800000</b>	-
TS 35 x 7,5	<b>0383400000</b>	-
TS 35 x 15	<b>0498000000</b>	-

### Ordering data

Type	Cat. No.	Qty.
SKHE 48	<b>0690660000</b>	1

#### E 48 (i.a.w. DIN 41612)

Assembly	e, c and a
Connection type	Screws

Insulation stripping length	7 mm
Terminal screw	M 2.5

Max. clamping range	0.13...1.5 mm <sup>2</sup>
„e“ solid HO7V-U	0.5...1.5 mm <sup>2</sup>
„f“ flexible HO7V-U	0.5...1.5 mm <sup>2</sup>
„f“ with ferrules	
according to DIN 46228/1	0.5...1.5 mm <sup>2</sup>
With plastic collar	0.5...1.5 mm <sup>2</sup>
Conductor cross-section	AWG 26...16
Conversion connection level/	1 : 1
Plug-in connector	
Plug gauge according to DIN/EN 50027 Size	A1

Rated voltage	125 V~
Rated current	5 A
Rated cross-section	1.5 mm <sup>2</sup>
Test voltage	1.25 kV~eff
Test torque	0.4 Nm
Ambient temperature	0 °C...+55 °C
Storage temperature	-40 °C...+70 °C

Overvoltage category	III
Pollution degree	2

Type	Cat. No.	Qty.
HP	<b>0137100000</b>	20

ZG	<b>0128000000</b>	-
ZG	<b>0128060000</b>	-

FM 4	<b>0687900000</b>	40
MB (M 3+M 5)	<b>0503500000</b>	100
MB (M 4+M 6)	<b>0334900000</b>	20
MP	<b>2054280000</b>	-

TS 32	<b>0122800000</b>	-
TS 35 x 7,5	<b>0383400000</b>	-
TS 35 x 15	<b>0498000000</b>	-

### Ordering data

Type	Cat. No.	Qty.
SKHF 32 (z/b)	<b>0586861001</b>	1
SKHF 32 (z/d)	<b>0586961001</b>	1

#### F 32 (i.a.w. DIN 41612)

Assembly	z and b ( <b>0586860000</b> ) /z and d ( <b>0586960000</b> )
Connection type	Screws

Insulation stripping length	7 mm
Terminal screw	M 2.5

Max. clamping range	0.13...4 mm <sup>2</sup>
„e“ solid HO7V-U	0.5...4 mm <sup>2</sup>
„f“ flexible HO7V-U	0.5...2.5 mm <sup>2</sup>
„f“ with ferrules	
according to DIN 46228/1	0.5...2.5 mm <sup>2</sup>
With plastic collar	0.5...2.5 mm <sup>2</sup>
Conductor cross-section	AWG 26...14
Conversion connection level/	1 : 1
Plug-in connector	
Plug gauge according to DIN/EN 50027 Size	A3

Rated voltage	250 V~
Rated current	6 A
Rated cross-section	2.5 mm <sup>2</sup>
Test voltage	1.25 kV~eff
Test torque	0.4 Nm
Ambient temperature	0 °C...+55 °C
Storage temperature	-40 °C...+70 °C

Overvoltage category	III
Pollution degree	2

Type	Cat. No.	Qty.
HP	<b>0137100000</b>	20

ZG	<b>0128000000</b>	-
ZG	<b>0128060000</b>	-

FM 4	<b>0687900000</b>	40
MB (M 3+M 5)	<b>0503500000</b>	100
MB (M 4+M 6)	<b>0334900000</b>	20
MP	<b>2054280000</b>	-

TS 32	<b>0122800000</b>	-
TS 35 x 7,5	<b>0383400000</b>	-
TS 35 x 15	<b>0498000000</b>	-



# Card Holders

- For inserting cards in Euro and double Euro format
- Convert IEC 603/DIN 41 612 and 41 617 plug-in connectors to LP connection elements

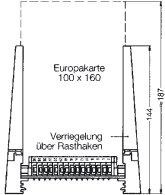

**SKHF 48**

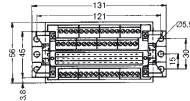

**SKHH 15**



**SKHE 48x2  
SKHF 48x2  
SKHC 64x2  
SKHD 32x2**

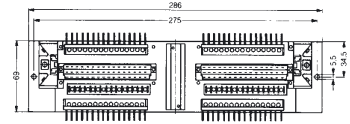
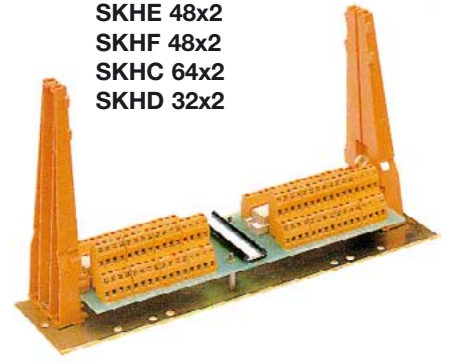

**Ordering data**

**Type Cat. No. Qty.**

SKHF 48	<b>0587060000</b>	1

**Type Cat. No. Qty.**

SKHH 15	<b>8051300000</b>	1

**Type Cat. No. Qty.**

SKHE 48 x 2	<b>0645760000</b>	1
SKHF 48 x 2	<b>8009260000</b>	1
SKHC 64 x 2	<b>8013120000</b>	1
SKHD 32 x 2	<b>8050981001</b>	1

**Technical data**

**Female connector block**  
 Assembly  
 Connection type

**F 48** (i.a.w. DIN 41612)  
 z, b and d  
 Screws

**H 15** (i.a.w. DIN 41612)  
 a and c  
 Screws

**For double Euro cards** 233 x 160 mm (i.a.w. DIN 41612)  
 Screws (S)

**Dimensions**

Insulation stripping length  
 Terminal screw

7 mm  
 M 2.5

7 mm  
 M 2.5

7 mm  
 M 2.5

**Clampable conductors**

Max. clamping range  
 „e“ solid HO7V-U  
 „f“ flexible HO7V-U  
 „f“ with ferrules  
 According to DIN 46228/1  
 With plastic collar  
 Conductor cross-section  
 Conversion connection level/  
 Plug-in connector  
 Plug gauge according to DIN/EN 50027 Size

0.13...1.5 mm<sup>2</sup>  
 0.5...1.5 mm<sup>2</sup>  
 0.5...1.5 mm<sup>2</sup>  
 0.5...1.5 mm<sup>2</sup>  
 0.5...1.5 mm<sup>2</sup>  
 AWG 26...16  
 1 : 1  
 A1

0.13...1.5 mm<sup>2</sup>  
 0.5...1.5 mm<sup>2</sup>  
 0.5...1.5 mm<sup>2</sup>  
 0.5...1.5 mm<sup>2</sup>  
 0.5...1.5 mm<sup>2</sup>  
 AWG 26...16  
 1 : 1  
 A1

0.13...1.5 mm<sup>2</sup>  
 0.5...1.5 mm<sup>2</sup>  
 0.5...1.5 mm<sup>2</sup>  
 0.5...1.5 mm<sup>2</sup>  
 0.5...1.5 mm<sup>2</sup>  
 AWG 26...16  
 1 : 1  
 A1

**Rated data**

Rated voltage  
 Rated current  
 Rated cross-section  
 Test voltage  
 Test torque  
 Ambient temperature  
 Storage temperature

125 V~  
 5 A  
 1.5 mm<sup>2</sup>  
 1.25 kV~eff  
 0.4 Nm  
 0 °C...+55 °C  
 -40 °C...+70 °C

250 V~  
 10 A  
 2.5 mm<sup>2</sup>  
 2.0 kV~eff  
 0.4 Nm  
 0 °C...+55 °C  
 -40 °C...+70 °C

125 V~  
 5 A  
 1.5 mm<sup>2</sup>  
 1.25 kV~eff  
 0.4 Nm  
 0 °C...+55 °C  
 -40 °C...+70 °C

**Insulation coordination according to EN 50 178**

Overvoltage category  
 Pollution degree

III  
 2

III  
 2

III  
 2

**Accessories**

Support plate  
 (To increase mechanical stability. Included in range of supply).

Type Cat. No. Qty.  
 HP **0137100000** 20

Type Cat. No. Qty.  
 HP **0137100000** 20

Type Cat. No. Qty.  
 HP **0136800000** 20

Grip white/black  
 Mounting foot for TS 35 (metal)  
 Mounting bracket for mounting on TS 32  
 Mounting plate  
 Mounting rail

ZG **0128000000** -  
 ZG **0128060000** -  
 FM 4 **0687900000** 40  
 MB (M3+M5) **0503500000** 100  
 MB (M4+M6) **0334900000** 20  
 MP (Euro card) **2054280000** -  
 TS 32 **0122800000** -  
 TS 35 x 7,5 **0383400000** -  
 TS 35 x 15 **0498000000** -

ZG **0128000000** -  
 ZG **0128060000** -  
 FM 4 **0687900000** 40  
 MB (M3+M5) **0503500000** 100  
 MB (M4+M6) **0334900000** 20  
 MP (Euro card) **2054280000** -  
 TS 32 **0122800000** -  
 TS 35 x 7,5 **0383400000** -  
 TS 35 x 15 **0498000000** -

ZG **0128000000** -  
 ZG **0128060000** -  
 FM 4 **0687900000** 40  
 MB (M3+M5) **0503500000** 100  
 MB (M4+M6) **0334900000** 20  
 MP (double Euro card) **2051430000** -  
 TS 32 **0122800000** -  
 TS 35 x 7,5 **0383400000** -  
 TS 35 x 15 **0498000000** -