

L0805C2N2SRMST

Aliases (L0805C2N2SRMST)

Obsolete

KEMET, L-RMS, RF, 0.0022 uH, +/-0.3 nH

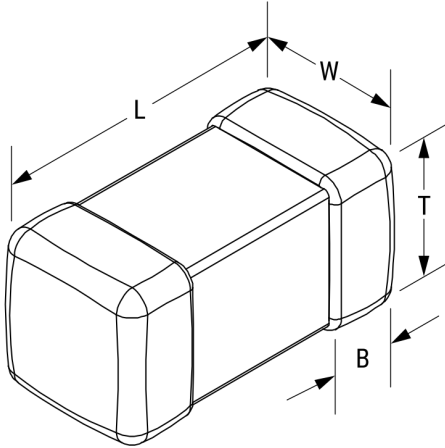

Click [here](#) for the 3D model.

Dimensions	
Chip Size	0805
L	2mm +0.3/-0.1mm
W	1.25mm +/-0.2mm
T	0.85mm +/-0.2mm
LL	0.5mm +/-0.3mm
B	0.5mm +/-0.3mm

Packaging Specifications	
Packaging	T&R
Packaging Quantity	4000

General Information	
Series	L-RMS
Style	SMD Chip
Description	Surface Mount Inductor
RoHS	Yes
Core	Ceramic
Winding Type	Multilayer

Specifications	
Inductance	0.0022 uH
Inductance Tolerance	+/-0.3 nH
Temperature Range	-40/+85°C
Current	300 mAmps (MAX)
DC Resistance	0.1 Ohms
Quality Factor	18 at 100 MHz, 46 at 500 MHz, 53 at 800 MHz, 58 at 1000 MHz
Self-Resonant Frequency	4000 MHz

Statements of suitability for certain applications are based on our knowledge of typical operating conditions for such applications, but are not intended to constitute - and we specifically disclaim - any warranty concerning suitability for a specific customer application or use. This Information is intended for use only by customers who have the requisite experience and capability to determine the correct products for their application. Any technical advice inferred from this Information or otherwise provided by us with reference to the use of our products is given gratis, and we assume no obligation or liability for the advice given or results obtained.